



SEGITECH



Manufacturers and Exporters of Surgical, Dental Instruments
and Scissors of All Sorts.

DENTAL *Instruments*
Catalogue

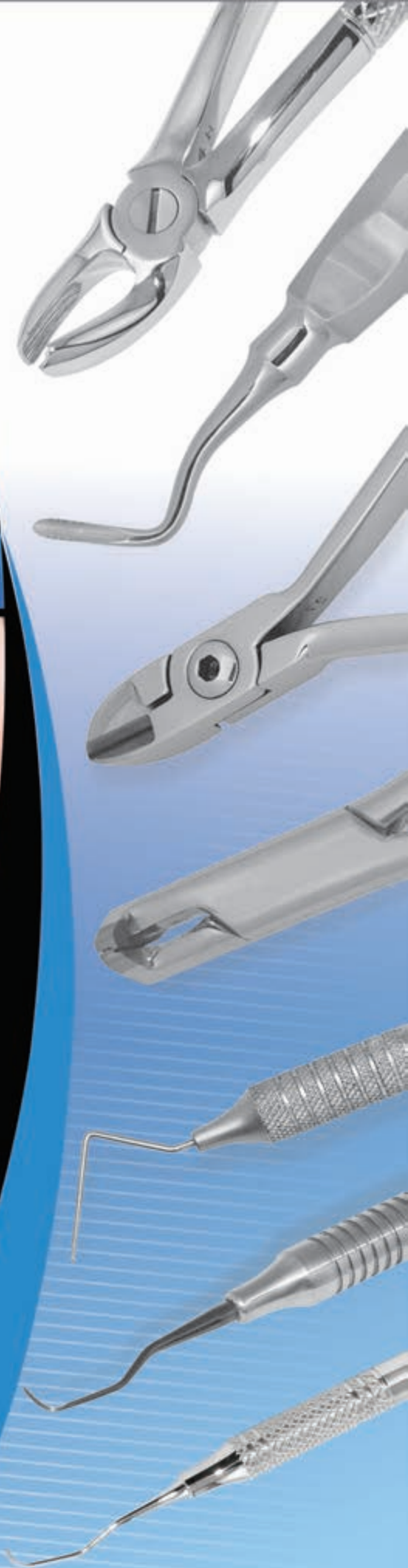

CONTENTS



Amalgam Carver	198-199
Amalgam Carriers	158-159
Amalgam Condensers	191-195
Articulators	279-285
Bone Curettes	123
Bone Rongeurs	95-100
Carving Instruments	214-220
Catridge Syringes	152-155
Cement Spatulas	221
Cheek Retractor	126-127
Chisels and Gouges	121-122
Crown Instruments	147-151
Crown Scissors	77
Denture Alloy Flask& Press	301-303
Diagnostic Inst	294-300
Dental Pliers	101-105
Dressing Forceps	109- to 116
Dissecting Forceps	106
Dissecting Kits	92
Enamel Instruments	189-190
Endodontic Instrument	164-167
Excavators	172-174
Extracting Forceps	1-48
Filling Instruments	200-212
Gingivectomy Knives	231-232
Gum Scissors	74 to 76
Hemostatic Forceps	93
Implants Surgery	233-234
Impression Trays	273-278
Instruments Trays	262-266
Lip Retractors	163
Luxator Set	309
Measurign Inst	287-292
Matrix Retainers & Matrix Bands	139-140
Micro Scissors	79-80
Micro Needle Holder	90-91



Mirrors Handles	143-145
Mouth Mirror	146
Mouth Gags	130-132
Napkin Holders	293
Needle Holders	81-89
Orthodontic Pliers	235-252
Periodontal Curettes	223-228
Periodontal Instruments	229-232
Periodontal Pocket Probes	160-161
Plaster Knives,Plaster Cutting Forceps & Spatulas	254-255-256
Polishing Instruments	213
Probes & Explorer	168-171
Retractors	124-125
Root Elevators	49-71
Root Tip Elevators	71-72
Root Splinter Forceps	47-48
Rubber Dam Clamps	136-138
Rubber Dam Forceps	133-135
Scalers	177-187
Scalpels , knives	101-102
Scissors	74-80
Sterilizing Forceps	260-261
Student Kits	257-259
Syndesmotomes	73
Tissue Forceps	107-108
Tongue Depressors	128
Tongue Holding Forceps	129
Towel Clamps	94
Wax Knives	253





SEGITECH



www.segitech.net



SEGITECH



Handle Options



M-0001a-00
Extraction forceps Medium
with Special Grip-power
Tips, Serrated handle and
Golden Finished Handle tips



M-0001B-00
Extraction forceps with
Friction grip and Anatomically
Shaped Handle



M-0001C-00
Extraction forceps
Friction grip and Serrated
Handle



M-0001D-00
Extraction forceps
Friction grip and Serrated
Handle



M-0001E-00
Extraction forceps with
Friction grip and Extra
Light Handle

Zahnzangen, Englische Form
Extracting Forceps, English Pattern

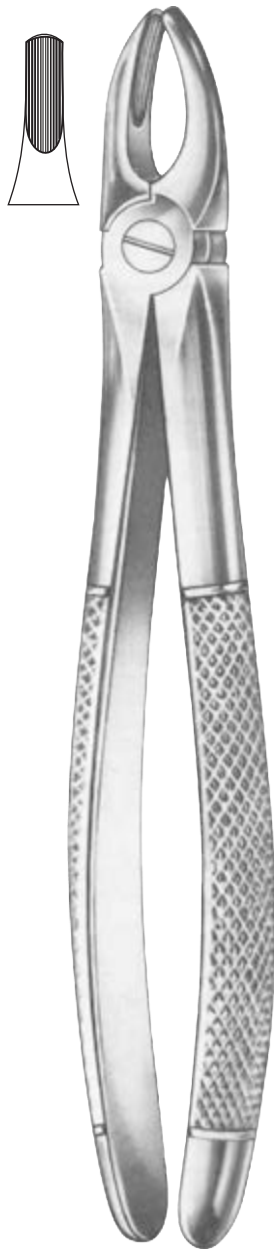

M-0001-01
 Fig. 1

obere Schneide- und Eckzähne
 upper centrals and canines



M-0002-02
 Fig. 2

obere Schneide- und Eckzähne
 upper laterals and canines



M-0003-03
 Fig. 3

● obere Schneide- und Eckzähne
 upper incisors and canines



M-0004-04
 Fig. 4

untere Schneide- und Eckzähne
 lower incisors and canines

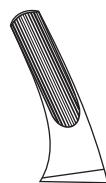

M-0005-07
 Fig. 7

obere prämolaren
 upper premolars

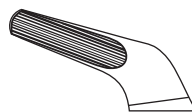

M-0006-08
 Fig. 8

untere prämolaren
 lower premolars

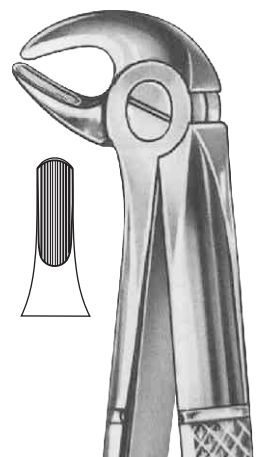

M-0007-13
 Fig. 13

untere prämolaren
 lower premolars



M-0008-17
 Fig. 17
 obere Molaren, rechts
 upper molars, right

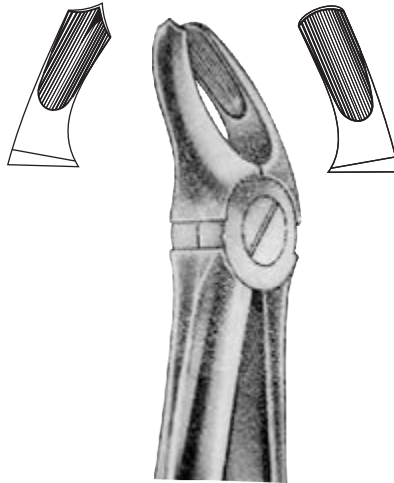

M-0009-18
 Fig. 18
 obere Molaren, links
 upper molars, left

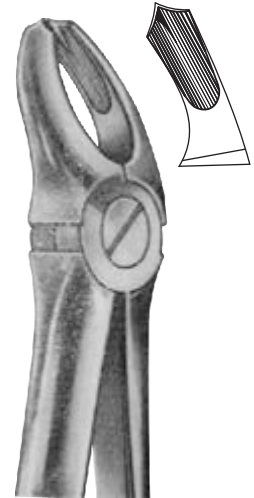

M-0009-18A
 Fig. 18A
 obere Molaren
 upper molars

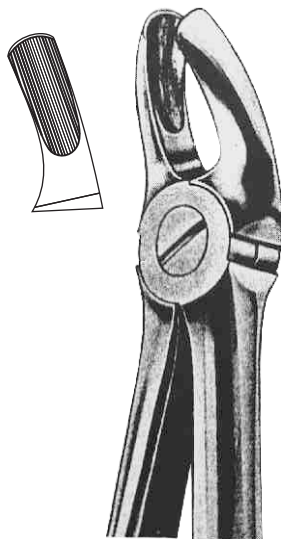

M-0009-18B
 Fig. 18B
 obere Molaren
 upper molars

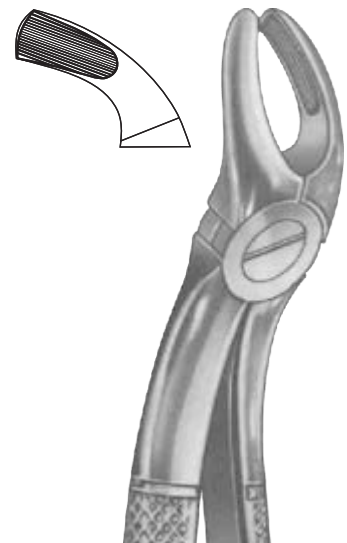

M-0010-19
 Fig. 19
 obere dritte Molaren
 upper third molars



M-0011-20
 Fig. 20
 untere dritte Molaren
 lower third molars

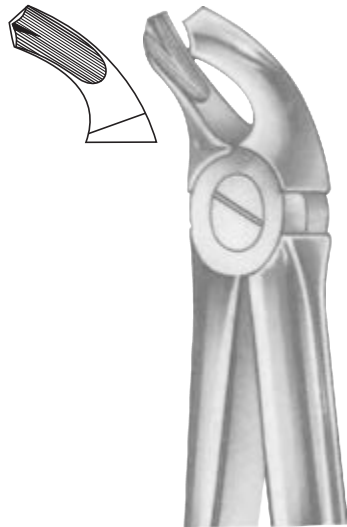

M-0012-21
 Fig. 21
 untere Molaren
 lower molars

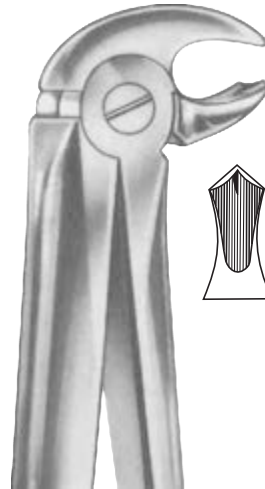

M-0013-22
 Fig. 22
 untere Molaren
 lower molars

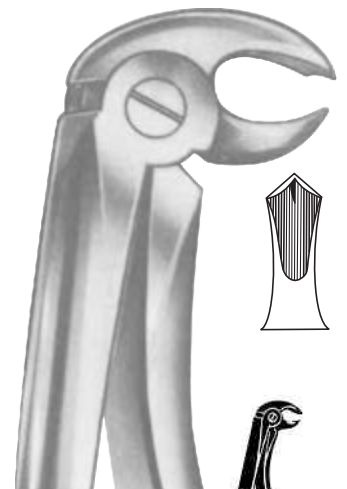

M-0013-22A
 Fig. 22A
 untere Molaren
 lower molars



M-0013-22G
 Fig. 22G
 untere Molaren
 lower molars

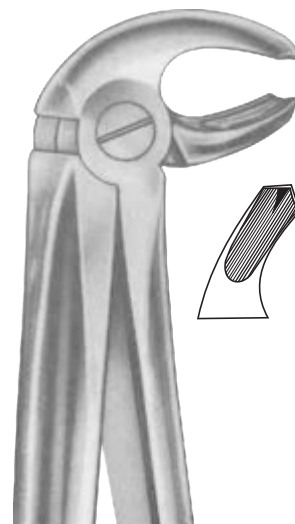

M-0014-23
 Fig. 23
 untere Molaren, rechts
 lower molars, right



M-0015-24
 Fig. 24
 untere Molaren, links
 lower molars, left



M-0016-29
 Fig. 29

obere Schneidezahne und Wurzeln
 upper incisors and roots

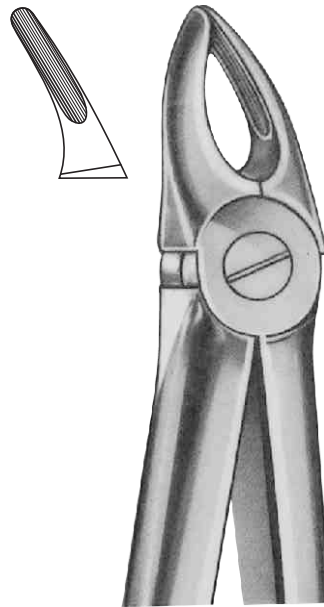

M-0017-30
 Fig. 30

obere Wurzeln
 upper roots

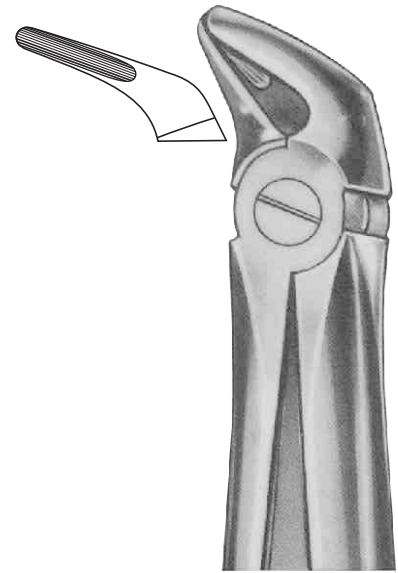

M-0018-31
 Fig. 31

Untere Wurzeln
 lower roots

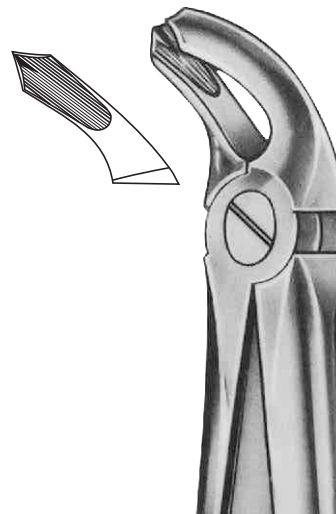

M-0019-32
 Fig. 32

Untere Molaren
 lower molars



M-0020-33
Fig. 33
untere Wurzeln, beide seiten
lower roots, either side

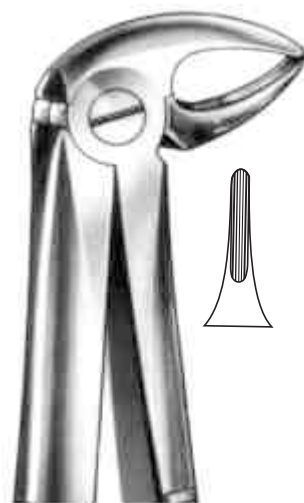

M-0020-33A
Fig. 33A
untere Wurzeln, beide seiten
lower roots, either side

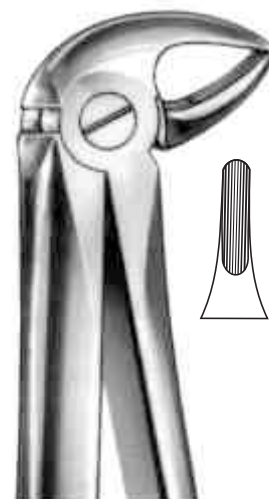

M-0020-33B
Fig. 33B
untere Wurzeln
lower roots



M-0020-01
Fig. 33½
untere Wurzeln
lower roots

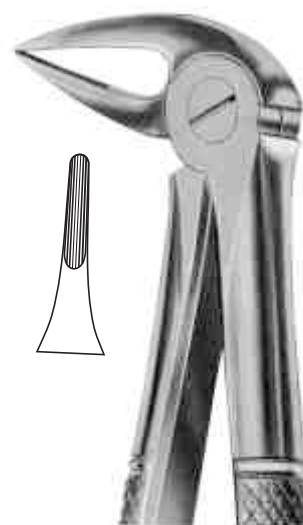

M-0020-33L
Fig. 33L
untere Wurzeln
lower roots



M-0021-41
 Fig. 41

untere Wurzeln
 lower roots

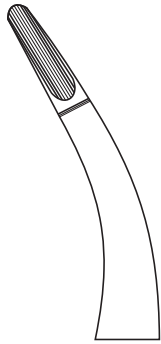

M-0022-44
 Fig. 44

obere Wurzeln
 upper roots

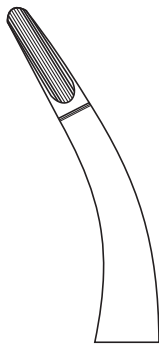

M-0023-48
 Fig. 48

untere Wurzeln
 lower roots

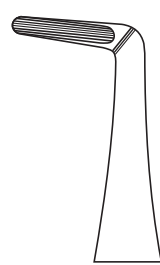

M-0024-45
 Fig. 45

obere Wurzeln
 upper roots



M-0025-49
 Fig. 49

untere Wurzeln
 lower roots

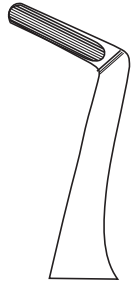

M-0026-50
 Fig. 50

untere Wurzeln
 lower roots

Zahnzangen, Englische Form
Extracting Forceps, English Pattern



M-0027-51
Fig. 51
obere Wurzeln
upper roots

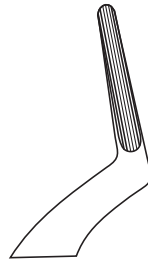

M-0027-51A
Fig. 51A
obere Wurzeln
upper roots

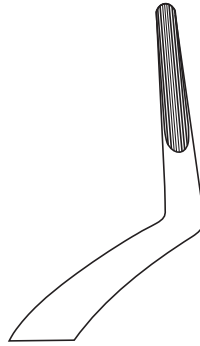

M-0027-51L
Fig. 51L
obere Wurzeln
upper roots

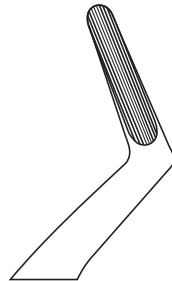

M-0028-52
Fig. 52
obere Wurzeln
upper roots

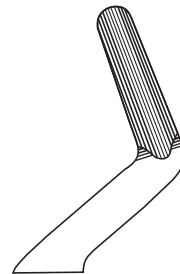

M-0028-52A
Fig. 52A
oberer Zahne und Resektion
upper teeth and resection



M-0029-54
Fig. 54
Spaltzänge für obere Molaren-wurzeln
separating forceps for roots of upper molars

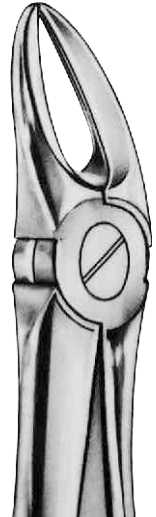

M-0030-55
Fig. 55

Spaltzange für obere Molaren-wurzeln
separating forceps for roots of upper molars



M-0031-56
Fig. 56

Spaltzänge für untere Molaren-wurzeln
Splitting Forceps for roots of lower molars



M-0032-67 ½ R
 Fig 67 ½ R

obere dritte Molaren, rechts
 upper third molars, right



M-0032-67 ½ L
 Fig. 67 ½ L

obere dritte Molaren, links
 upper third molars, left

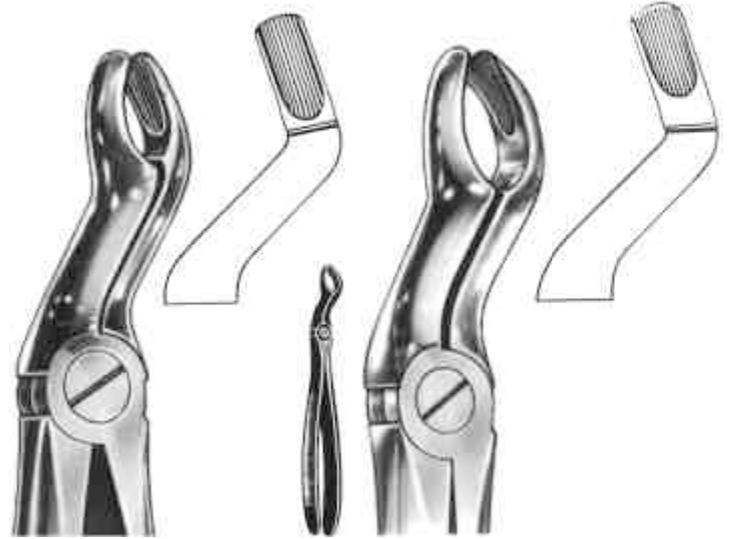

M-0032-067
 Fig. 67

obere Weisheitszähne
 upper wisdoms

M-0032-67A
 Fig. 67A



M-0033-68
 Fig. 68

Untere Wurzeln
 lower roots

M-0033-68A
 Fig 68A

Untere Wurzeln
 lower roots

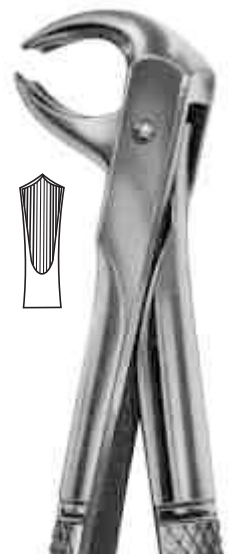

M-0034-73
 Fig. 73

untere Molaren
 lower molars

Zahnzangen, Englische Form
Extracting Forceps, English Pattern



M-0034-73A
Fig. 73A
untere Molaren
lower molars

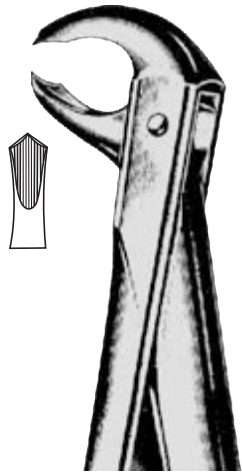

M-0034-73B
Fig. 73B
untere Molaren, für Kinder
lower molars, for children



M-0034-73L
Fig. 73L
untere Wurzeln, links
lower roots, left



M-0035-74
Fig. 74
untere Wurzeln
lower roots

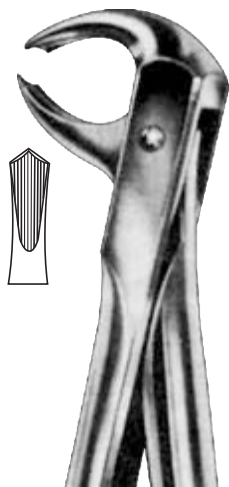

M-0034-73S
Fig. 73S
untere Molaren
lower molars
molares inferiores
molaires inferieures
molari inferiori



M-0034-73R
Fig. 73R
untere Wurzeln, rechts
lower roots, right

M-0034-73K
Fig. 73K
untere Molaren, für Kinder
lower molars, for children

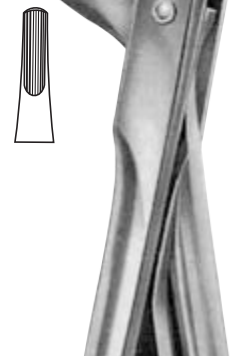
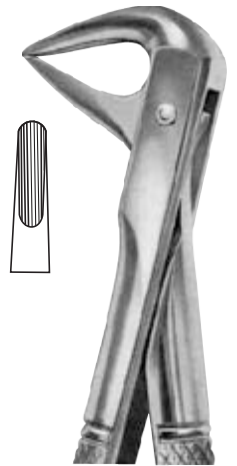

M-0035-74D
Fig. 74D
untere Wurzeln
lower roots



M-0035-74M
 Fig. 74M
 Untere Wurzeln
 lower roots

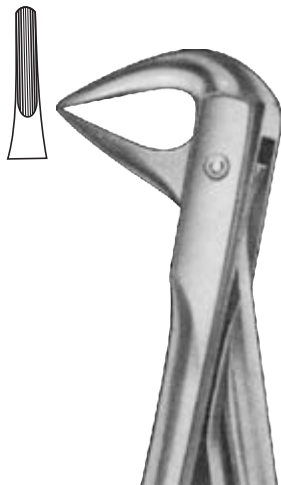

M-0035-74N
 Fig. 74N
 Untere Wurzeln
 lower roots

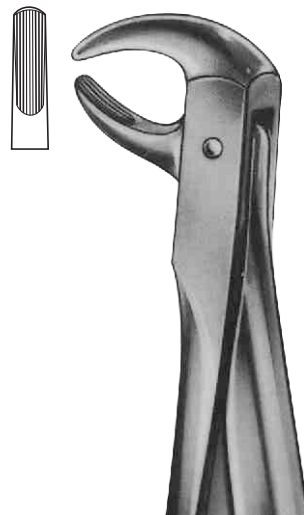

M-0036-75
 Fig. 75
 untere Pramolaren
 lower premolars

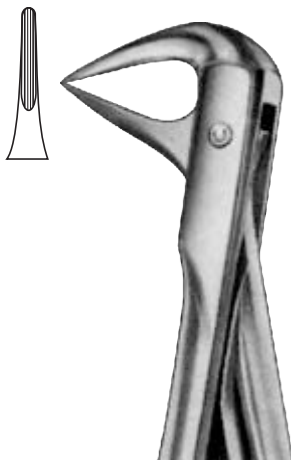

M-0035-74NX
 Fig. 74NX
 Untere Wurzeln und engstehende
 schneidezahne
 lower roots and crowded incisors



M-0037-76
 Fig. 76
 obere Wurzeln
 upper roots



M-0037-76N
 Fig. 76N
 obere Wurzeln
 upper roots



M-0038-79
Fig. 79
untere Weisheitszähne
lower wisdoms

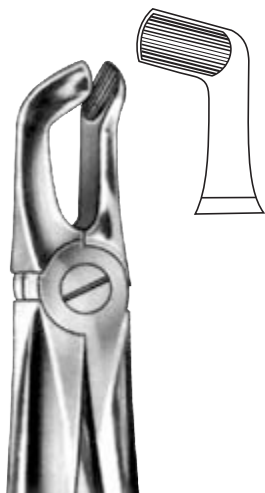

M-0038-79A
Fig. 79A
untere Weisheitszähne
lower wisdoms



M-0039-80
Fig. 80
obere Molaren Wurzeln
upper molars roots



M-0040-86A
Fig. 86A
untere Molaren
lower molars



M-0040-86B
Fig. 86B
untere Molaren
lower molars



M-0040-86C
Fig. 86C
untere Molaren
lower molars

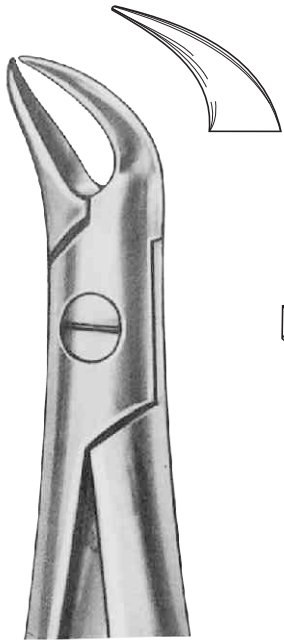

M-0041-87
 Fig. 87

untere Molaren mit kariösen oder ab-
 gebrochenen kronen (Kuhhornschnabel)
 lower molars with decayed or



M-0044-92
 Fig. 92

obere Molaren, rechts
 upper right molars

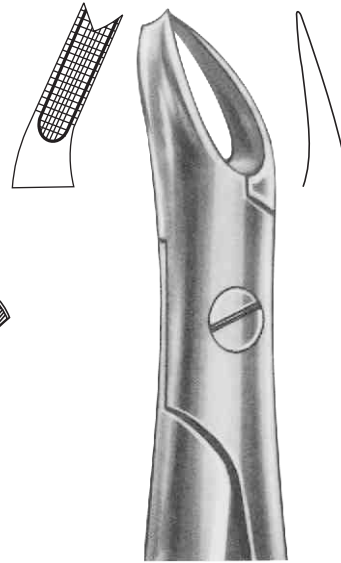

M-0042-89
 Fig. 89

obere Molaren, rechts
 upper right molars

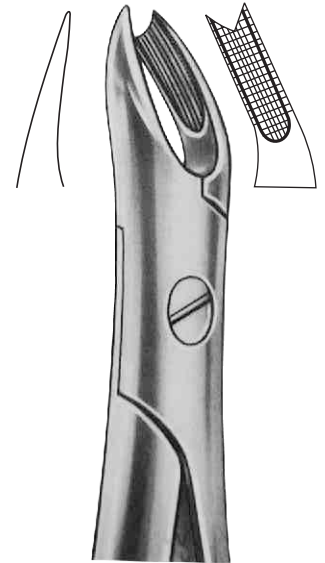

M-0043-90
 Fig. 90

obere Molaren, links
 upper left molars

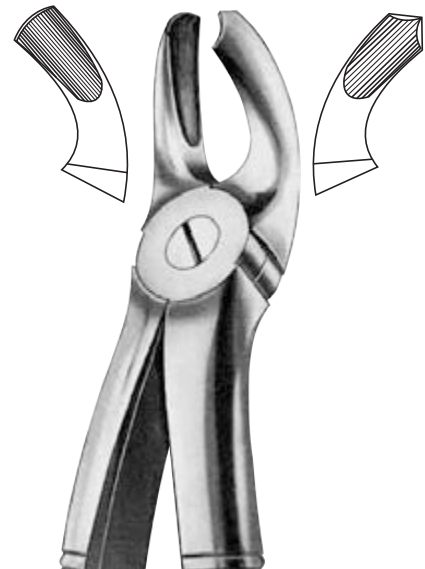

M-0045-93
 Fig. 93

obere Molaren, links
 upper left molars

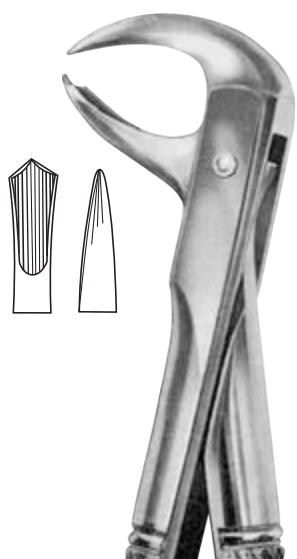

M-0046-99
Fig. 99
untere Molaren
lower molars

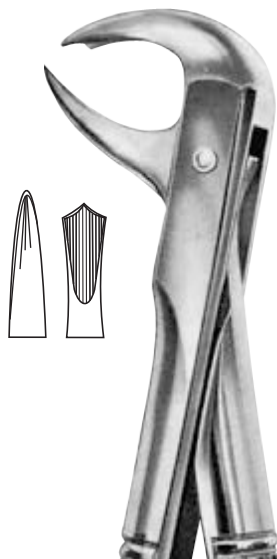

M-0046-99½
Fig. 99½
untere Molaren
lower molars

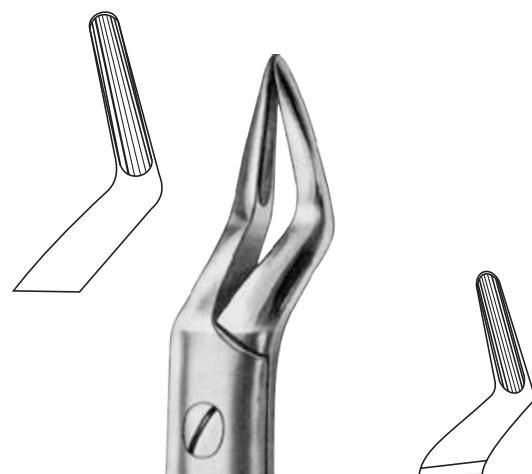

M-0049-104
Fig. 104
obere Wurzeln und Prämolaren
upper roots and premolars

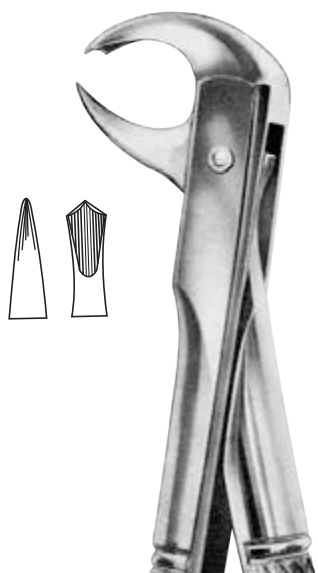

M-0046-99¼
Fig. 99¼
untere Molaren
lower molars

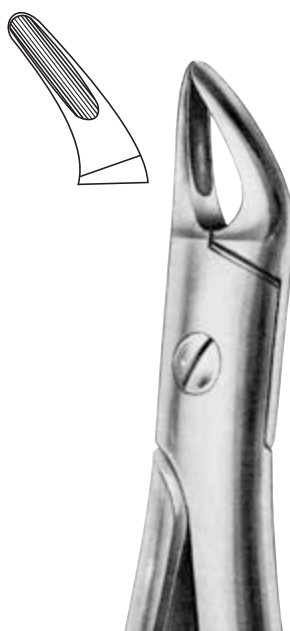

M-0047-100
Fig. 100
obere Wurzeln
upper roots



M-0048-101
Fig. 101
obere Wurzeln und Prämolaren
upper roots and premolars



M-0050-102
 Fig. 102

obere Molaren, rechts
 upper right molars



M-0051-103
 Fig. 103

obere Molaren, links
 upper left molars

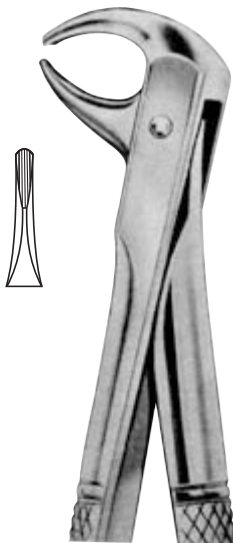

M-0052-105
 Fig. 105

untere Schneidezähne
 lower incisors

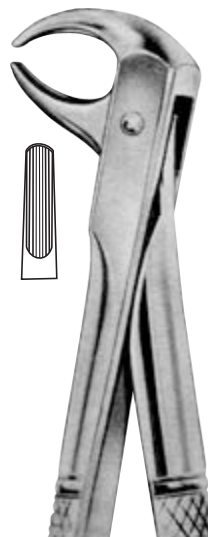

M-0053-106
 Fig. 106

untere Schneidezähne
 lower incisors



M-0054-107
 Fig. 107

obere Schneide- und Eckzähne
 upper incisors and bicuspid

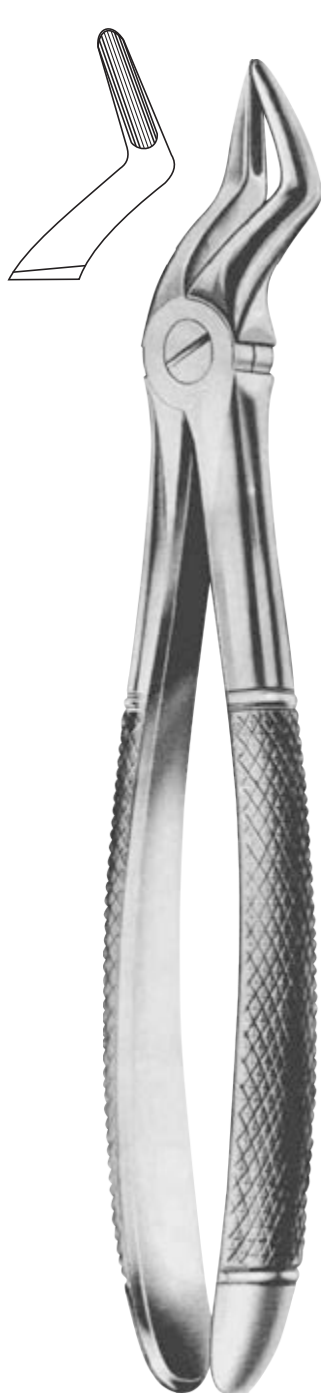

M-0055-112
Fig. 112
obere Wurzeln
upper roots



M-0056-113
Fig. 113
obere Wurzeln
upper roots

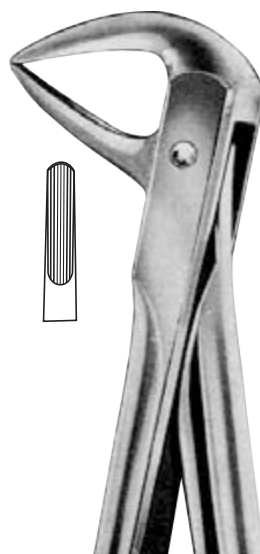

M-0057-114
Fig. 114
Untere Wurzeln
lower roots

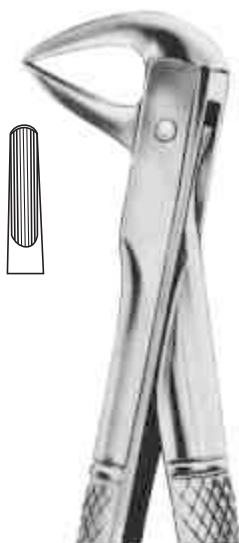

M-0058-137
Fig. 137
untere Schneidezähne und Wurzeln
lower incisors and roots

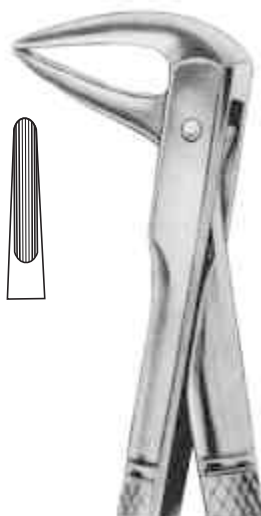

M-0059-143
Fig. 143
Untere Wurzeln
lower roots

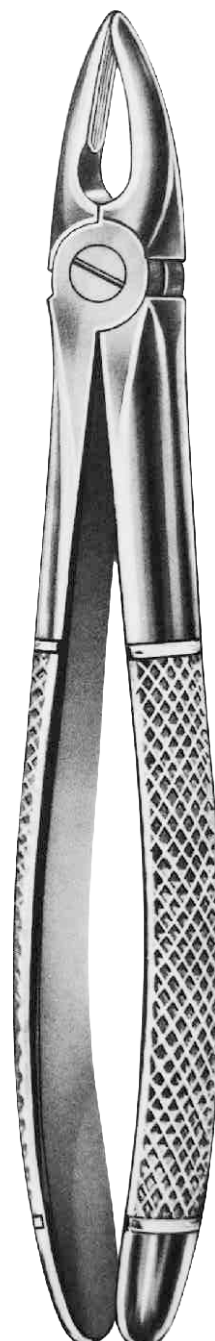

M-0060-MD1
Fig. MD1
obere Schneide-, Eckzähne und Wurzeln
upper incisors, bicuspid and roots

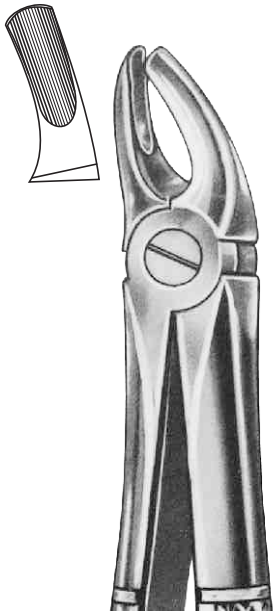

M-0060-MD2
 Fig. MD2
 obere Molaren
 upper molars



M-0060-MD4
 Fig. MD4
 untere Molaren
 lower molars

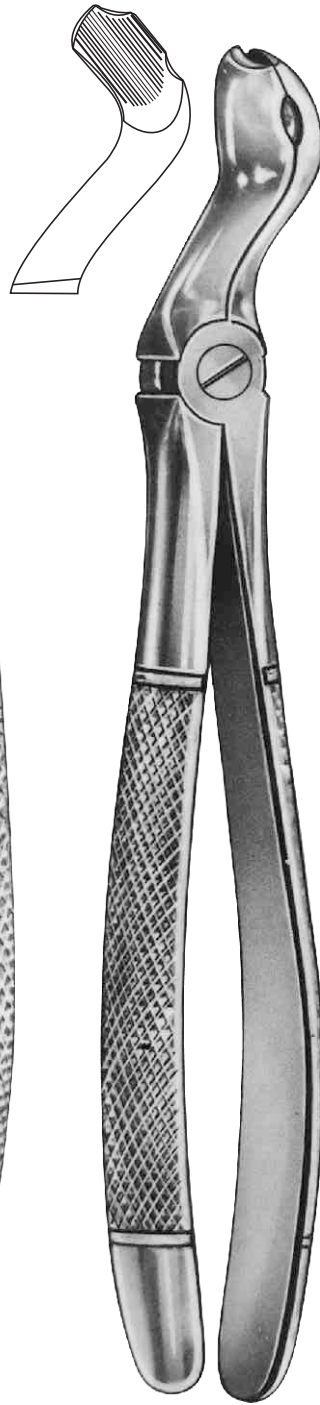

M-0061-01F
 Felsch
 obere Weisheitszähne
 upper wisdoms

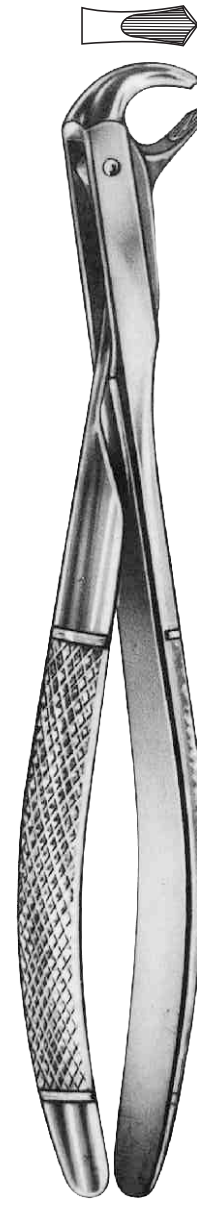

M-0062-01S
 STIKSA
 Fig. 1
 untere Molaren und Weisheitszähne
 lower molars and wisdoms

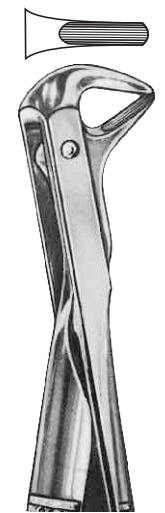

M-0062-02S
 STIKSA
 Fig. 2
 untere Molaren, Weisheitszähne, Wurzeln
 lower molars, wisdoms, roots

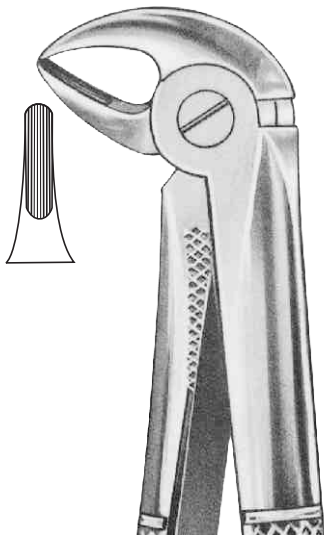

M-0060-MD3
 Fig. MD3
 untere Wurzeln, Schneide- und Eckzähne
 lower roots, incisors and bicuspid



M-0063-22½ L
Fig. 22½ L
Wisdom routurier

untere Molaren und Weisheitszähne, links
lower molars and wisdom, left



M-0063-22½ R
Fig. 22½ R
Wisdom-routurier

untere Molaren und Weisheitszähne, rechts
lower molars and wisdom, right

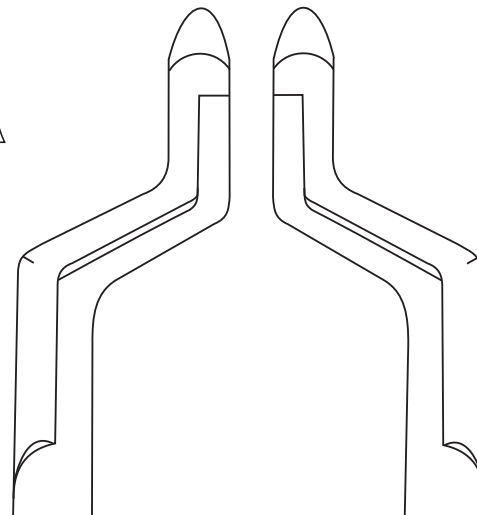

M-0064-33½ L
Fig. 33½ L
Wisdom-routurier

untere Molaren, Weisheitszähne, Wurzeln, links
lower molars, wisdoms, roots, left



M-0064-33½ R
Fig. 33½ R
Wisdom-routurier

untere Molaren, Weisheitszähne, Wurzeln, rechts
lower molars, wisdoms, roots, right





M-0065-13S
 Fig. 13S
 untere Prämolaren
 lower premolars

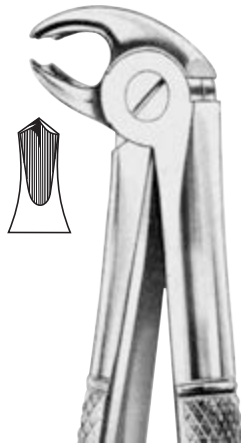

M-0066-22S
 Fig. 22S
 untere Molaren
 lower molars

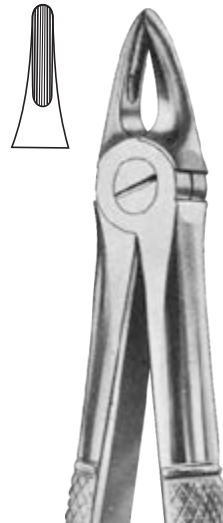

M-0067-29S
 Fig. 29S
 obere Wurzeln
 upper roots



M-0068-30S
 Fig. 30S
 obere Wurzeln
 upper roots

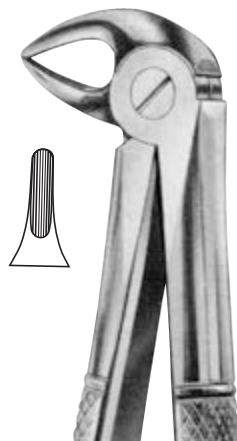

M-0069-33S
 Fig. 33S
 untere Wurzeln
 lower roots



M-0070-37
 Fig. 37
 obere Schneide-und Eckzähne
 upper incisors and canines

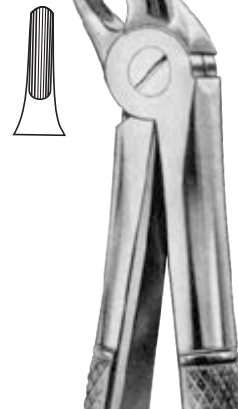

M-0071-38
 Fig. 38
 untere Schneide-und Eckzähne
 lower incisors and canines

KinderZahnzangen, Englische Form
Extracting Forceps for Children, English Pattern

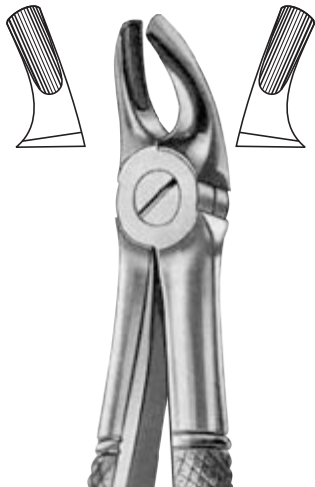

M-0072-39
 Fig. 39
 obere Molaren
 upper molars

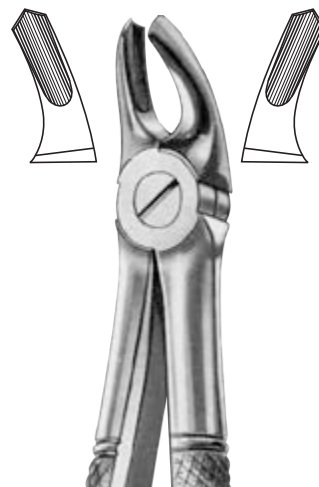

M-0072-39R
 Fig. 39R
 obere Molaren, rechts
 upper molars, right



M-0072-39L
 Fig. 39L
 obere Molaren, links
 upper molars, left



M-0074-51S
 Fig. 51S
 obere Wurzeln
 upper roots

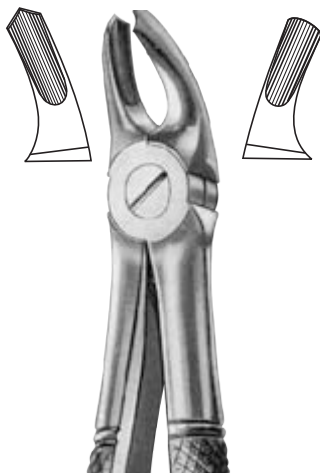

M-0072-39A
 Fig. 39A
 obere Molaren, rechts
 upper molars, right

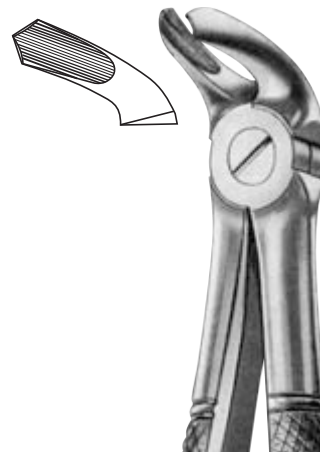

M-0073-40
 Fig. 40
 untere Molaren
 lower molars

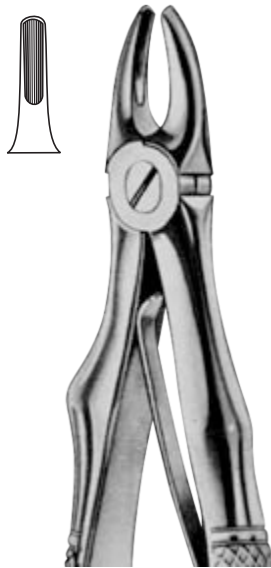

M-0075-1K
 Fig. 1

obere Schneidezahne
 upper incisors

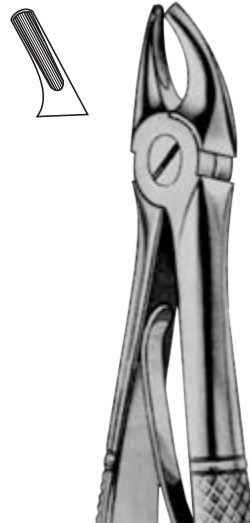

M-0075-2K
 Fig. 2

obere Prämolaren
 upper premolars

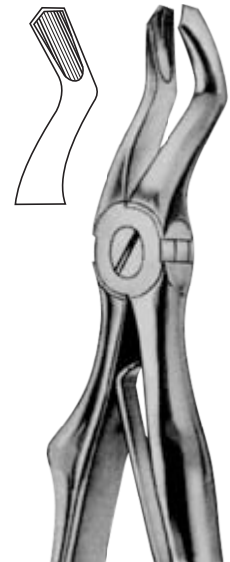

M-0075-3K
 Fig. 3

obere Molaren
 upper molars



M-0075-4K
 Fig. 4

obere Wurzein
 upper roots



M-0075-5K
 Fig. 5

untere Schneidezahne
 lower incisors



M-0075-6K
 Fig. 6

untere Molaren
 lower molars

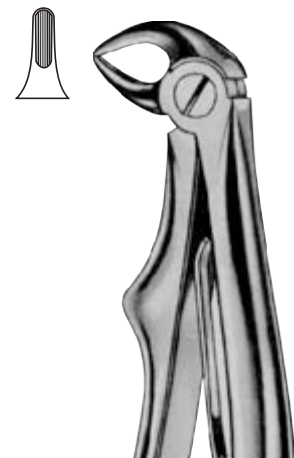

M-0075-7K
 Fig. 7

untere Wurzein
 lower roots

Kinderzahnzangen, Englische Form
Extracting Forceps for Children, English Pattern



M-0076-01
Fig. 1

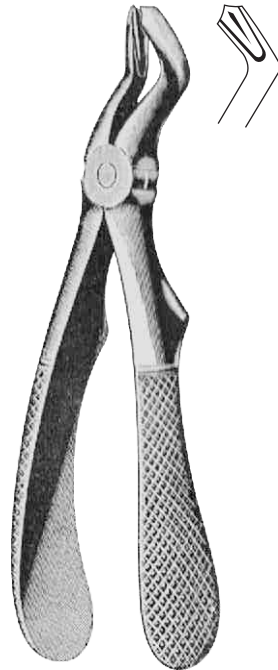

M-0077-03
Fig. 3

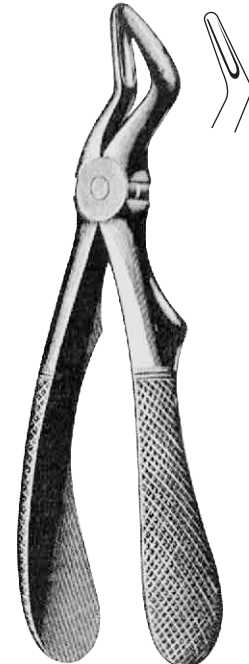

M-0078-04
Fig. 4

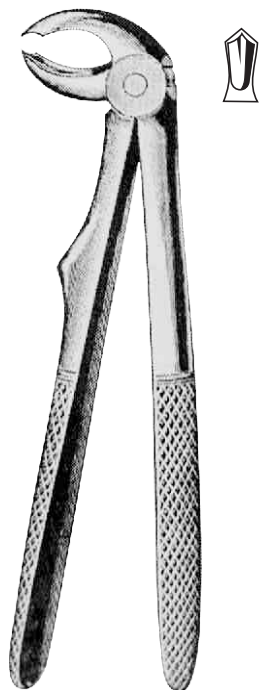

M-0079-06
Fig. 6

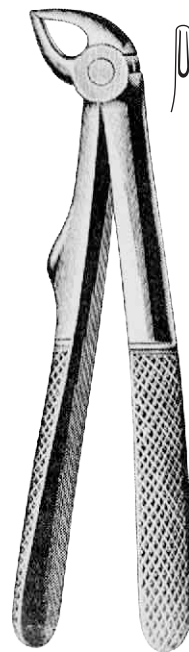

M-0080-07
Fig. 7

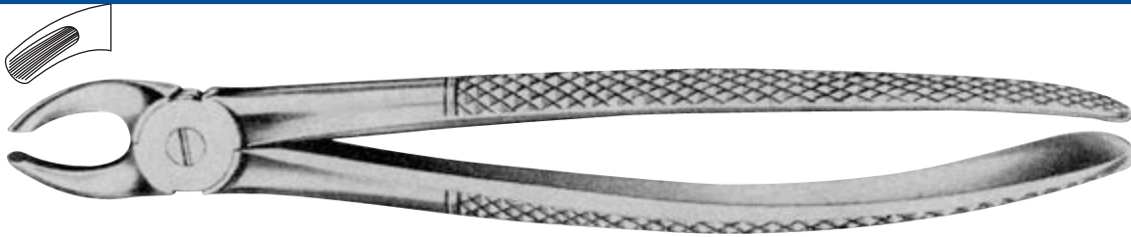

M-0081-158
 Fig.158
 Children's upper molars
 universal

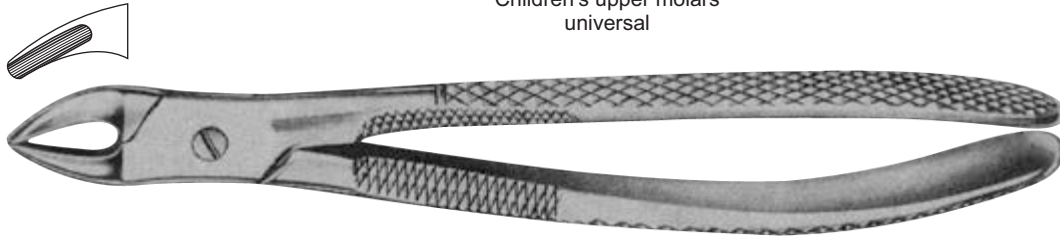

M-0082-159
 Fig.159
 Children's upper teeth
 universal



M-0083-160
 Fig.160
 Children's lower molars
 universal (Hawk's bill)

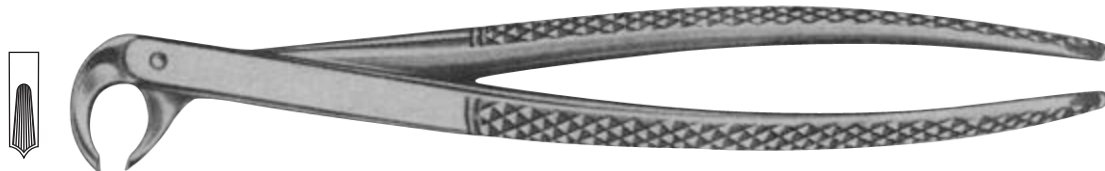

M-0084-161
 Fig.161
 Children's lower centrals & roots

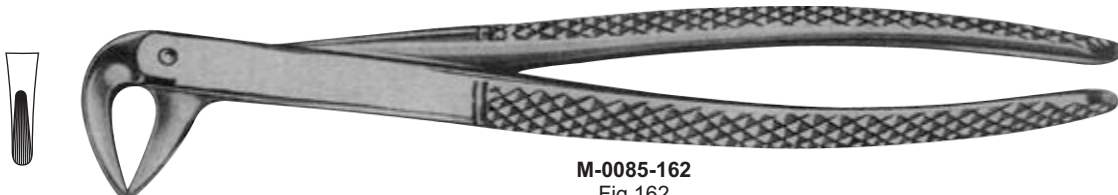

M-0085-162
 Fig.162
 Children's upper centrals



M-0086-163
 Fig.163
 Children's upper centrals

KinderZahnzangen, Englische Form
Extracting Forceps for Children, English Pattern

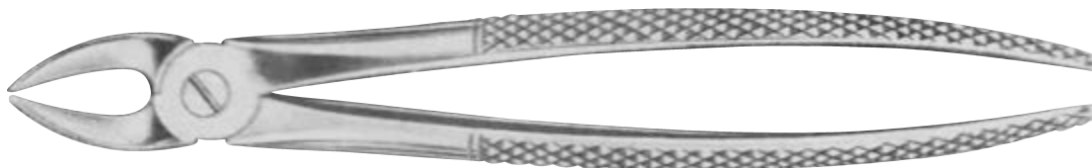

M-0087-37
Fig.37
Children's upper incisors & canines

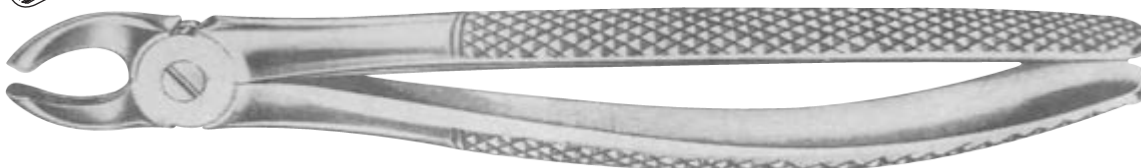

M-0088-39
Fig.39
Children's upper molars
universal

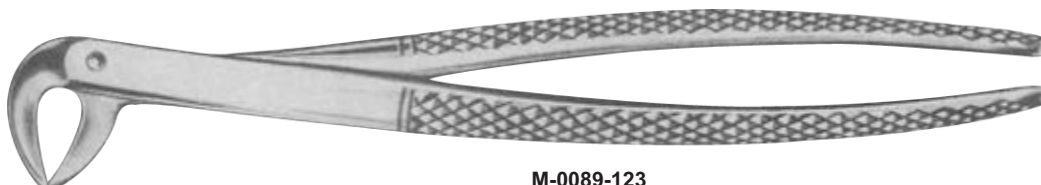

M-0089-123
Fig.123
Children's lower teeth
universal

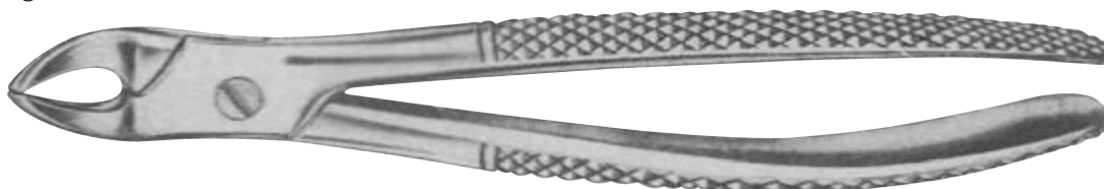

M-0090-138
Fig.138
Children's upper
universal & roots

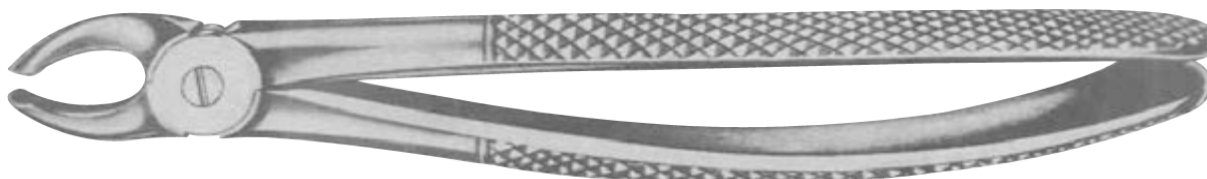

M-0091-157
Fig.157
Children's upper
molars universal

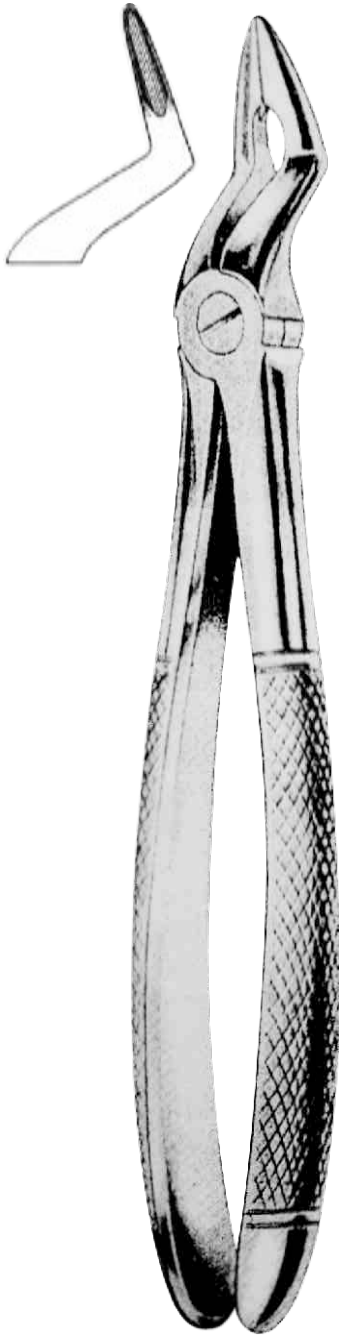

M-0092-00
Witzel

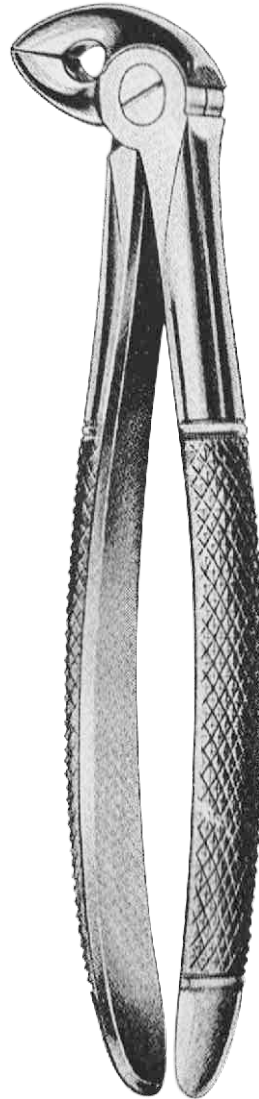
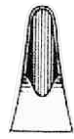

M-0093-00

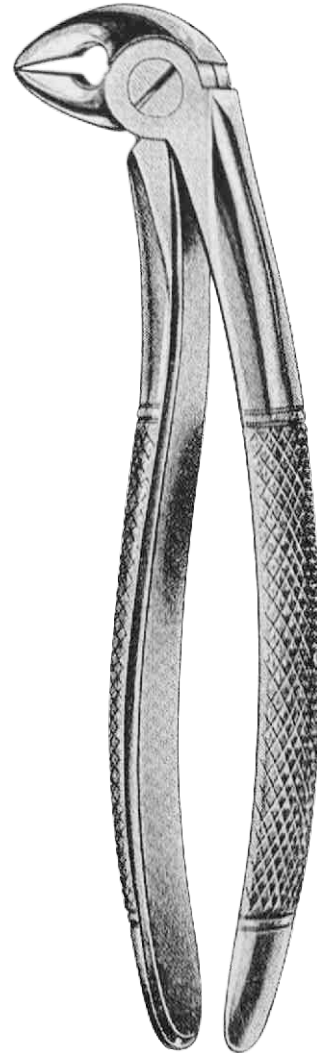
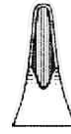

M-0094-00

Busch

Zahnzangen, Englische Form
Extracting Forceps, English Pattern



M-0095-00
Hertz

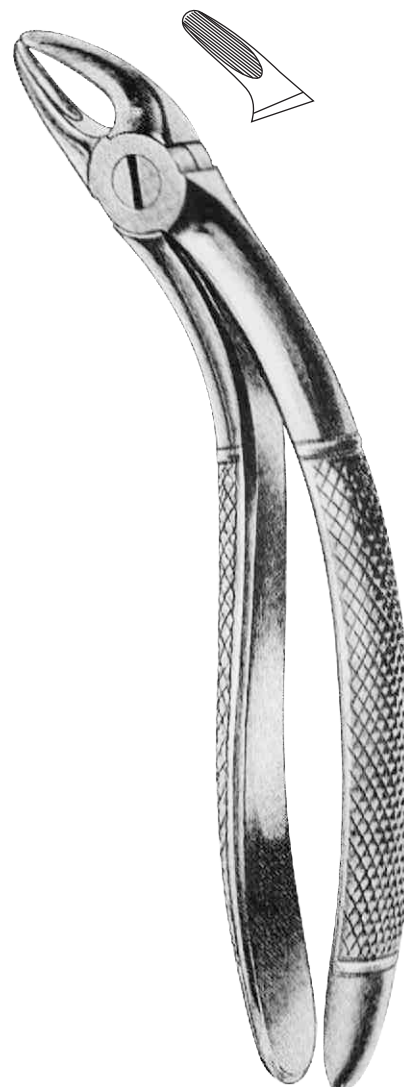

M-0096-00
Hertz

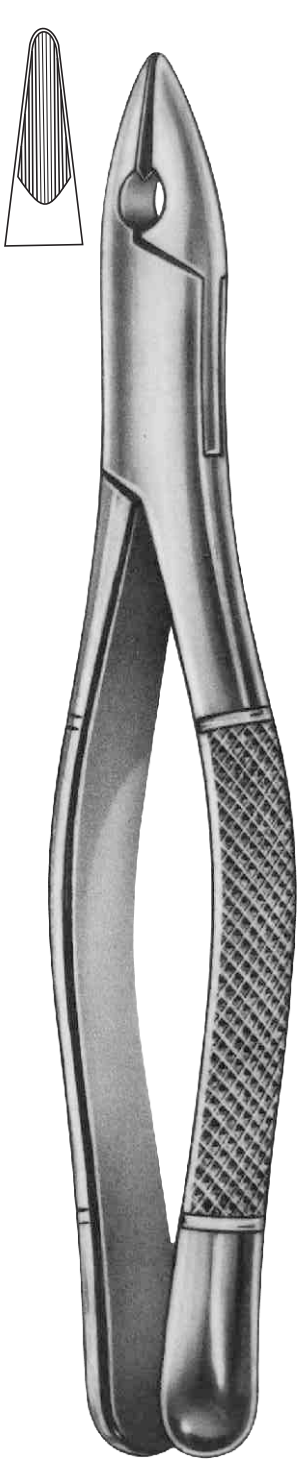

M-0097-01
 Fig.1
 standart

obere Schneide- und Eckzähne
 upper incisors and canines



M-0098-01
 Fig. 1A

obere Schneidezähne und Wurzeln
 upper incisors and roots

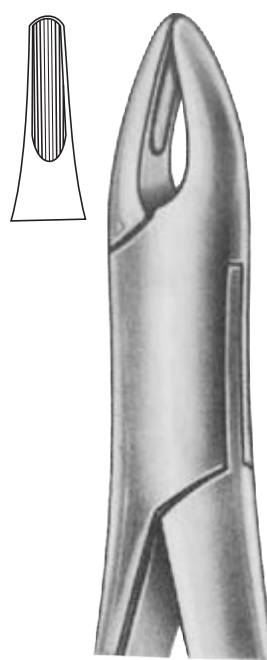

M-0098-02
 Fig. 1B
 Normal

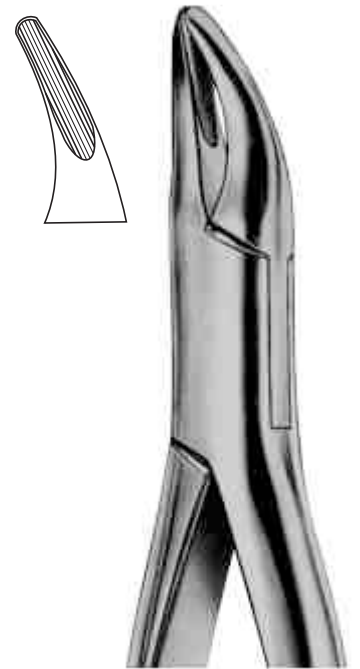

M-0099-02
 Fig. 2

obere und untere Wurzeln
 upper and lower roots

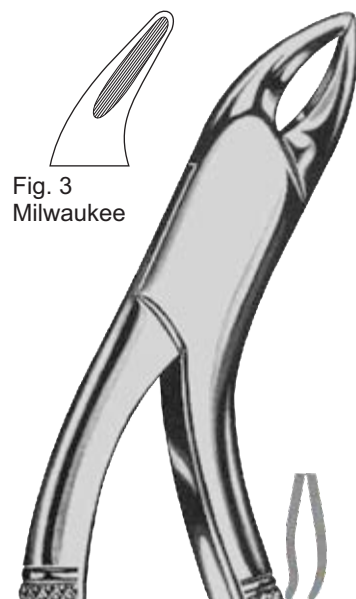

Fig. 3
 Milwaukee

M-0100-03
 Fig. 3
 Milwaukee

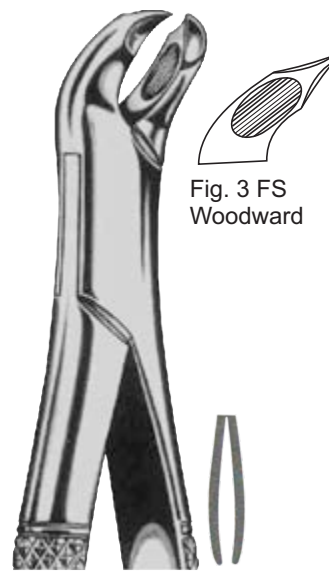

Fig. 3 FS
 Woodward

M-0101-3 FS
 Fig. 3 FS
 Woodward



M-0102-04
 Fig. 4

untere und obere Prämolaren
 upper and lower premolars

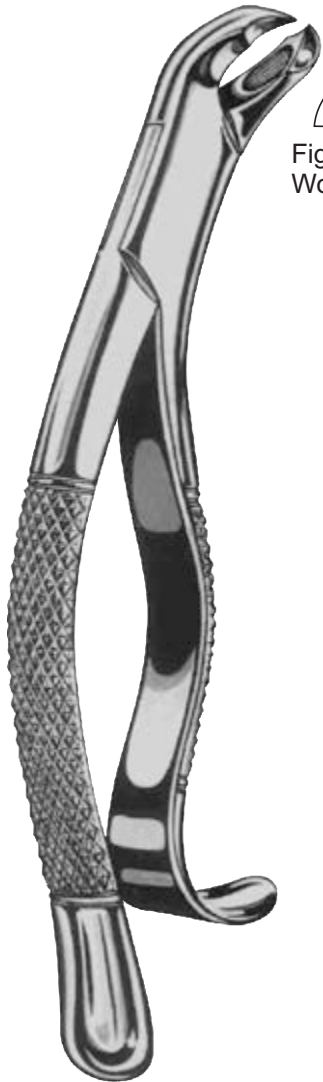

M-0103-3 FH
 Fig. 3 FH
 Woodward

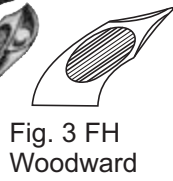
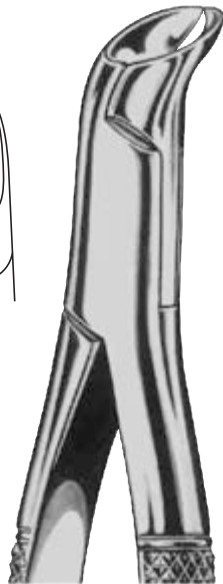
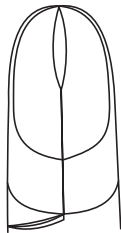
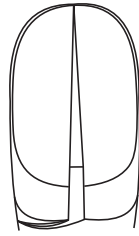
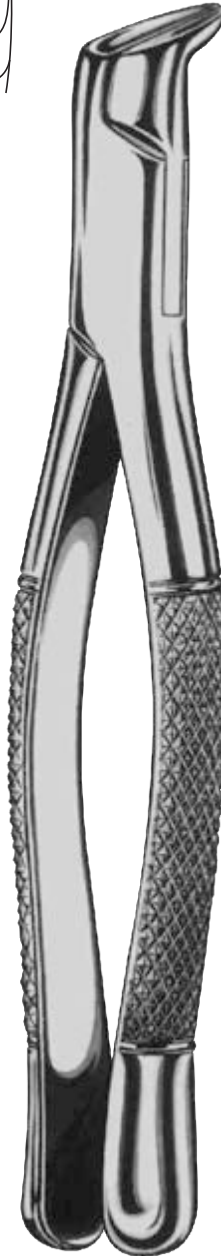

Fig. 3 FH
 Woodward



M-0104-05
 Fig. 5
 untere Weisheitszähne
 lower third molars



M-0105-06
 Fig. 6
 untere Molaren, Spaltzange
 lower molars, splitting forceps

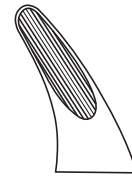

M-0106-07
 Fig. 7
 obere Wurzeln
 upper roots

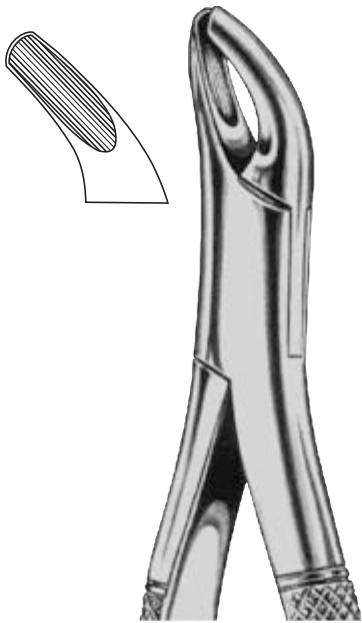

M-0107-08
Fig. 8
 obere und untere Molaren
 upper and lower molars

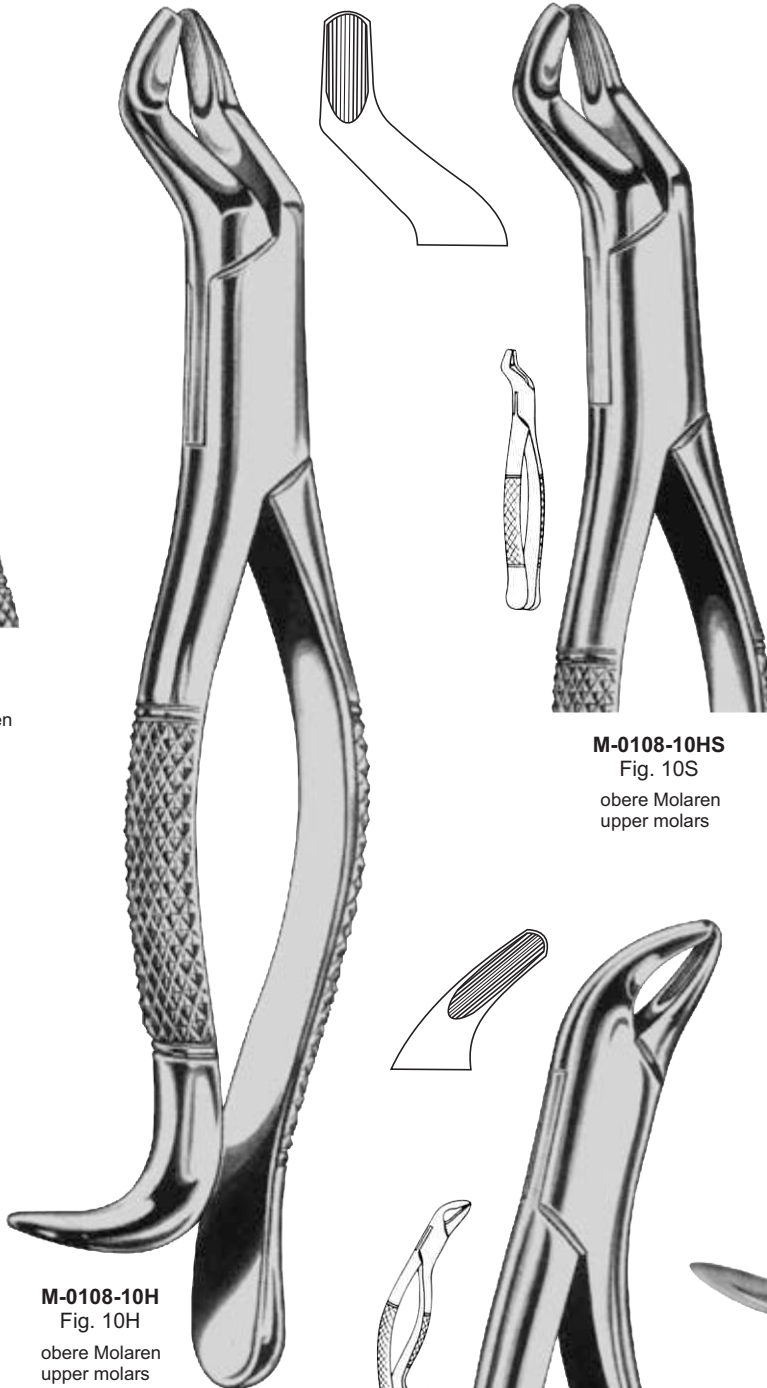

M-0108-10HS
Fig. 10S
 obere Molaren
 upper molars

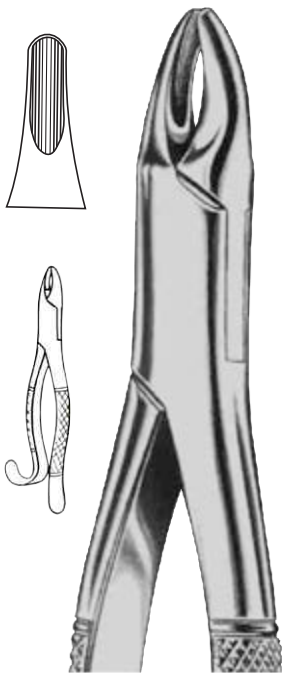

M-0108-10H
Fig. 10H
 obere Molaren
 upper molars

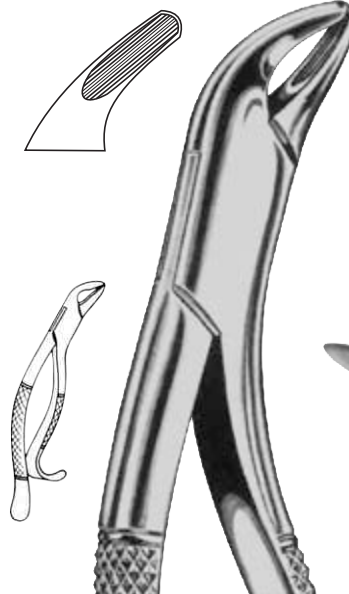

M-0109-13
Fig. 13
 obere Schneidezahne
 upper incisors



M-0110-14
Fig. 14
 untere Schneidezahne
 lower incisors



M-0111-15
Fig. 15

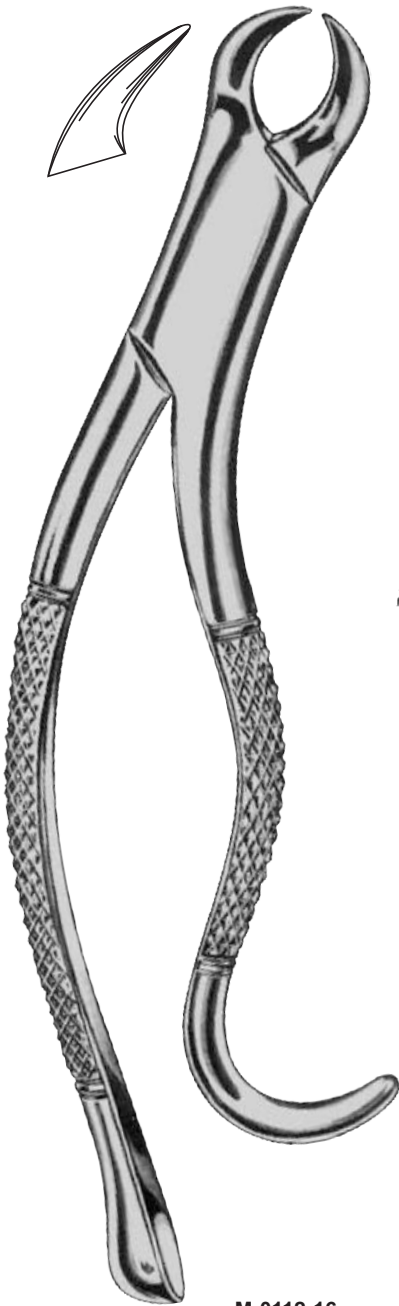

M-0112-16
 Fig. 16
 untere Molaren
 lower molars

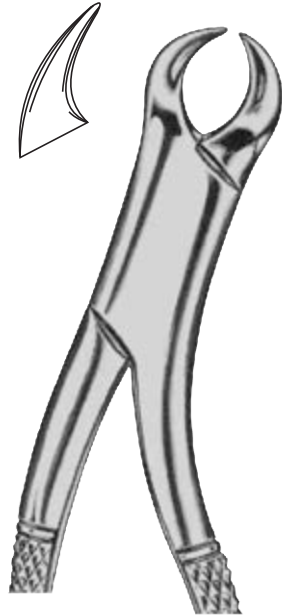

M-0113-16S
 Fig. 16S
 untere Molaren, für Kinder
 lower molars, for children

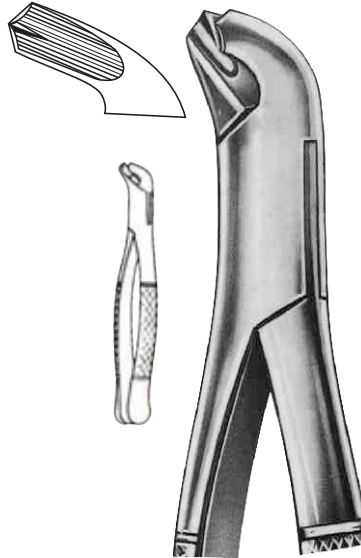

M-0114-17
 Fig. 17
 untere Molaren
 lower molars

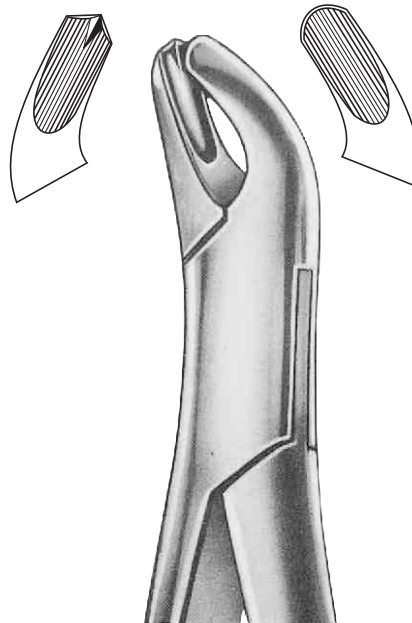

M-0115-18L
 Fig. 18L
 obere Molaren, links
 upper molars, left



M-0115-18R
 Fig. 18R
 obere Molaren, rechts
 upper molars, right



M-0116-20R

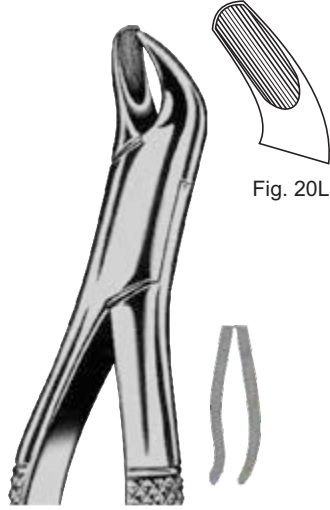

M-0116-20L

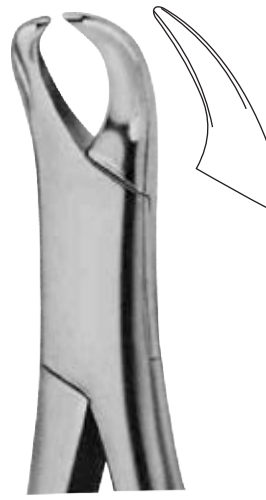

M-0117-23
Fig. 23

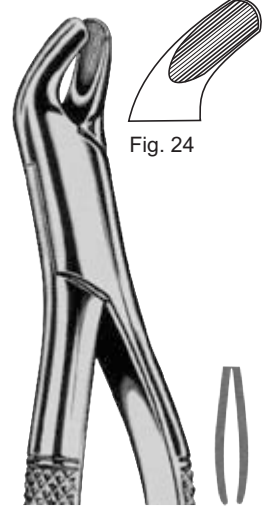

M-0118-24
Fig. 24

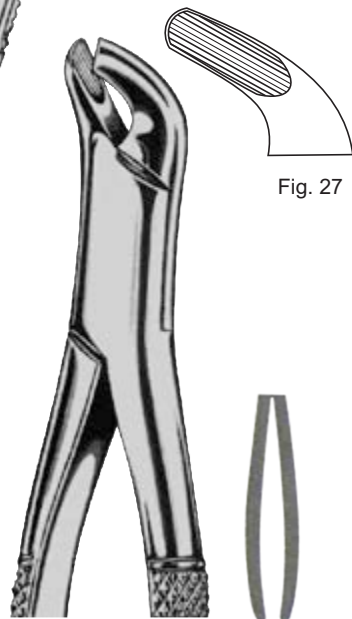
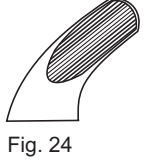

M-0119-27

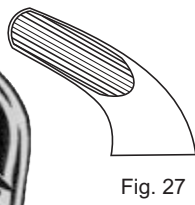

M-0120-29S

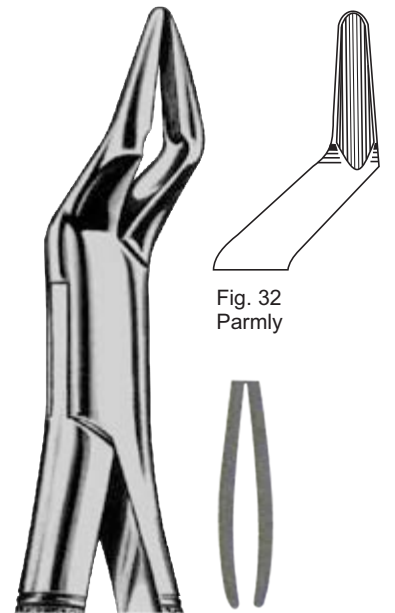
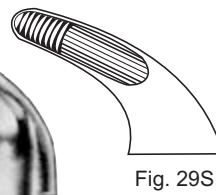

M-0121-32

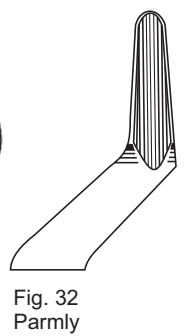

Zahnzangen, amerikanische form
Extracting Forceps, american Pattern

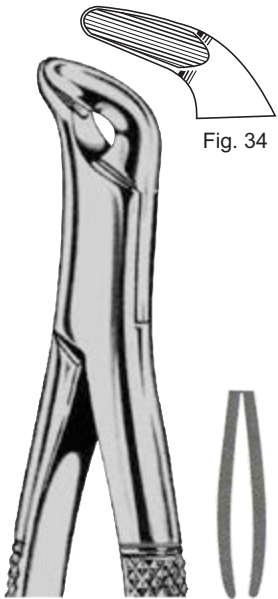

M-0122-34

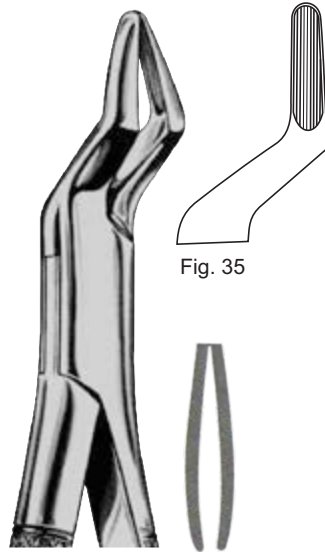

M-0123-35

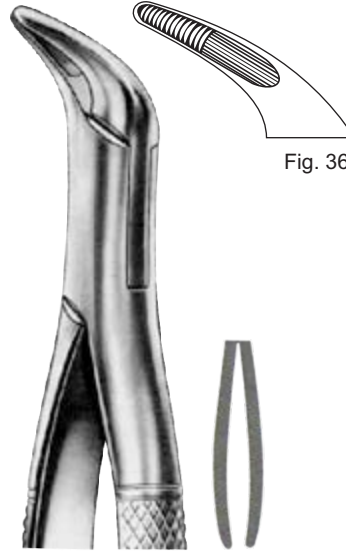

M-0124-36

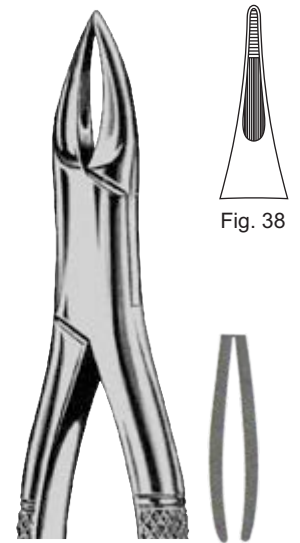

M-0125-38

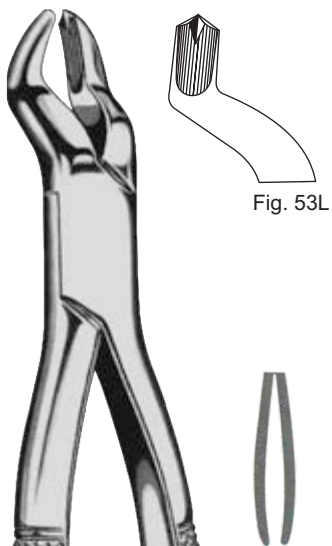

M-0126-53L

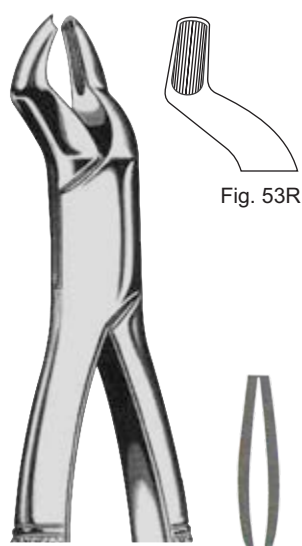

M-0126-53R

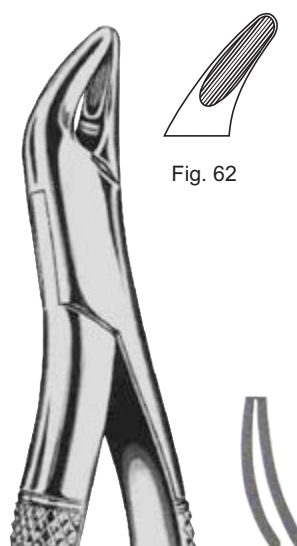

M-0127-62

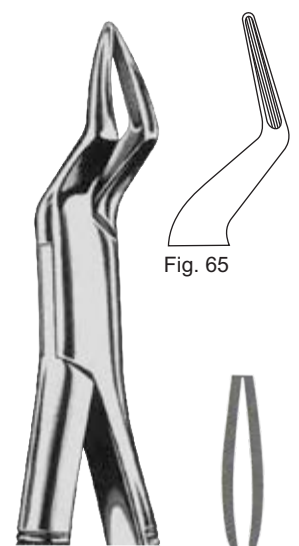

M-0128-65

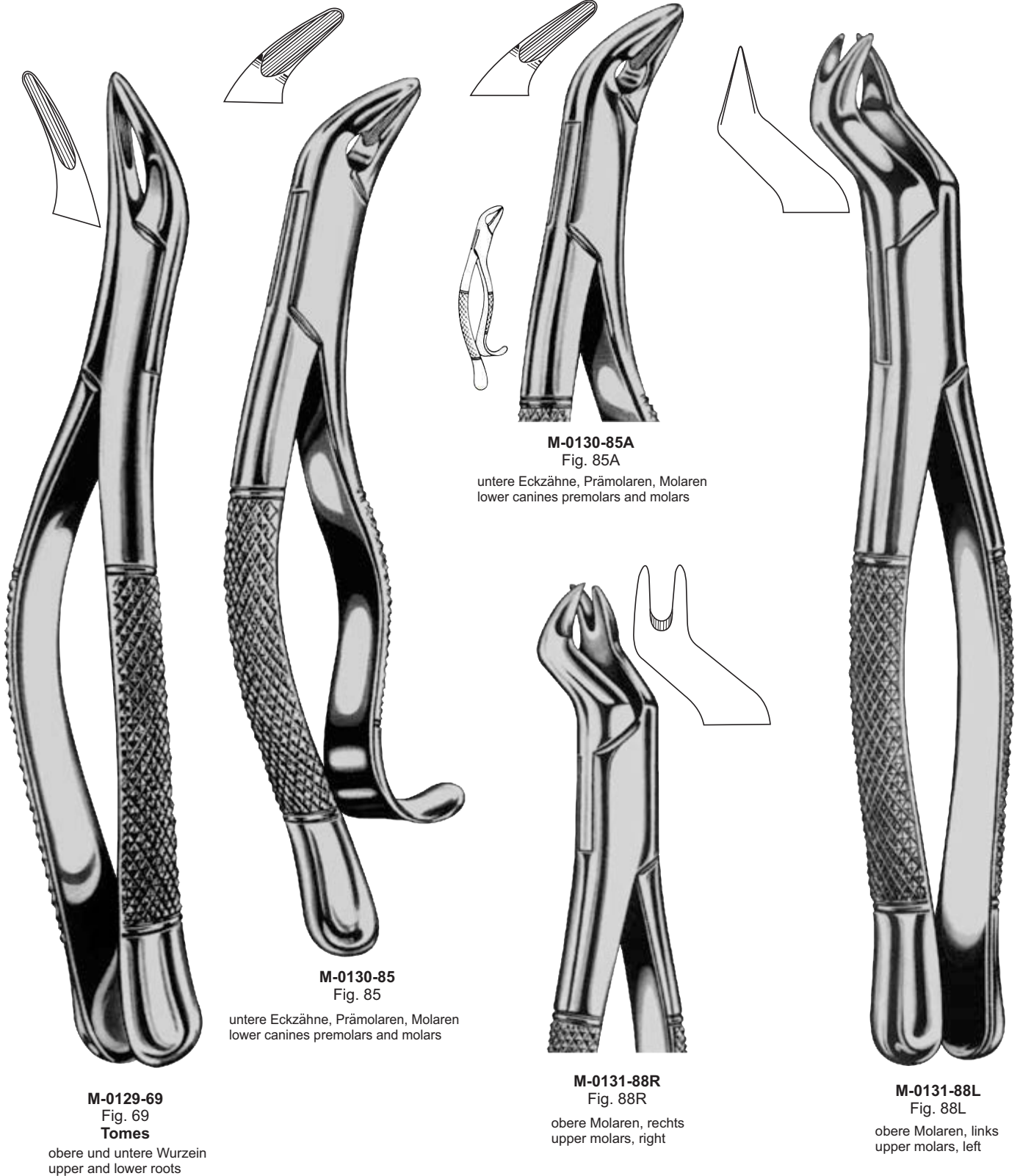

M-0129-69
Fig. 69
Tomes

obere und untere Wurzeln
upper and lower roots

M-0130-85
Fig. 85

untere Eckzähne, Prämolaren, Molaren
lower canines premolars and molars

M-0130-85A
Fig. 85A

untere Eckzähne, Prämolaren, Molaren
lower canines premolars and molars

M-0131-88R
Fig. 88R

obere Molaren, rechts
upper molars, right

M-0131-88L
Fig. 88L

obere Molaren, links
upper molars, left

Zahnzangen, amerikanische form
Extracting Forceps, american Pattern



M-0132-99A
Fig. 99A

obere Schneide- und Eckzähne, Prämolaren
upper incisors and canines, premolars

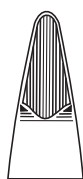
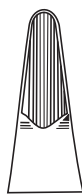

M-0132-99C
Fig. 99C

obere Schneide- und Eckzähne, Prämolaren
upper incisors and canines, premolars
incisivos y caninos, premolares superiores
incisives et canines, premolaires superieures
incisivi e canini, premolari superiori



M-0133-101
Fig. 101
Hull

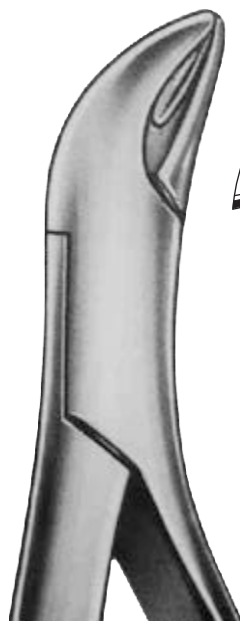

M-0134-103
Fig. 103

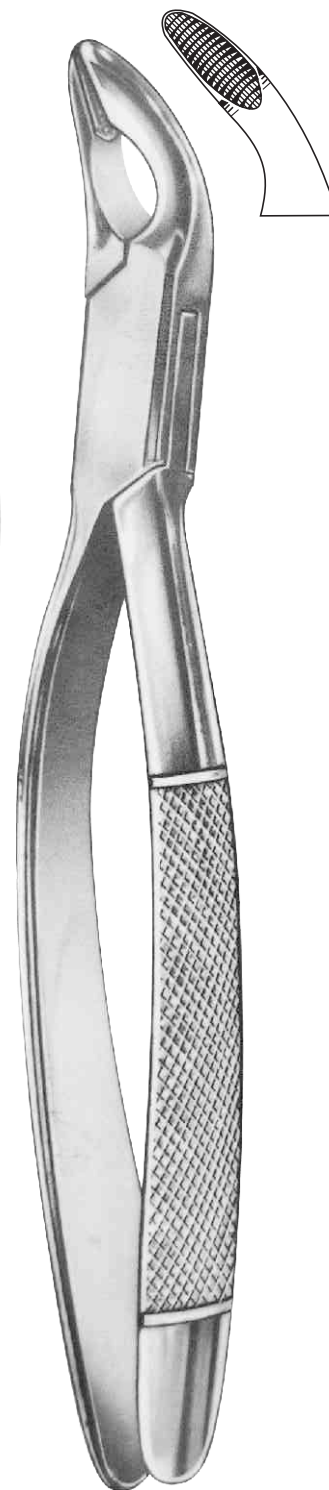

M-0135-150
Cohen
universal
universal

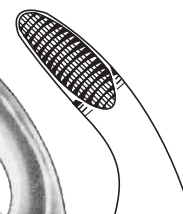

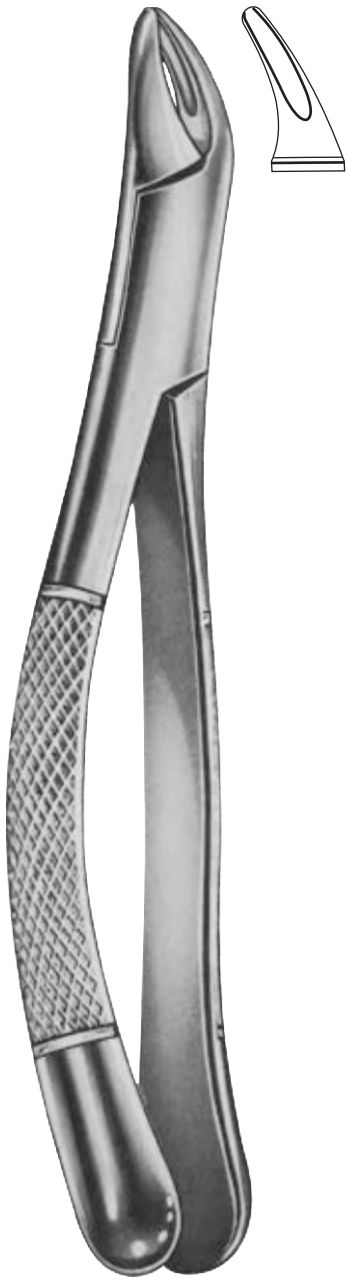

M-0136-150
Fig. 150
Cryer

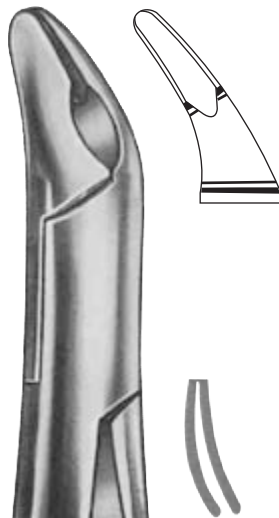

M-0136-150 A
Fig. 150 A
Cryer

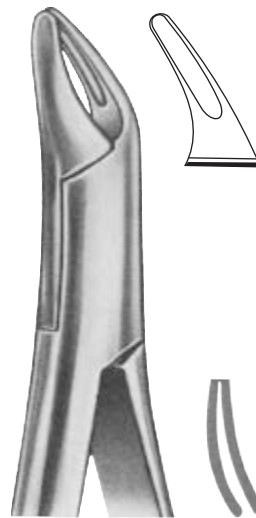

M-0136-150 S
Fig. 150 S
Cryer



M-0137-151
Fig. 151
Cryer

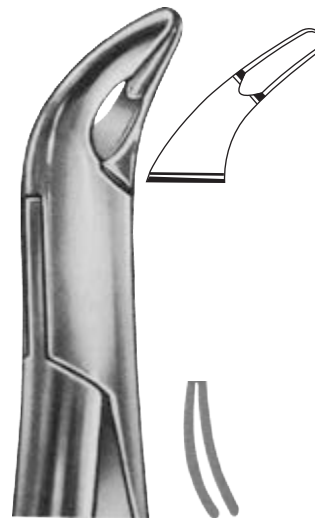

M-0137-151 A
Fig. 151 A
Cryer

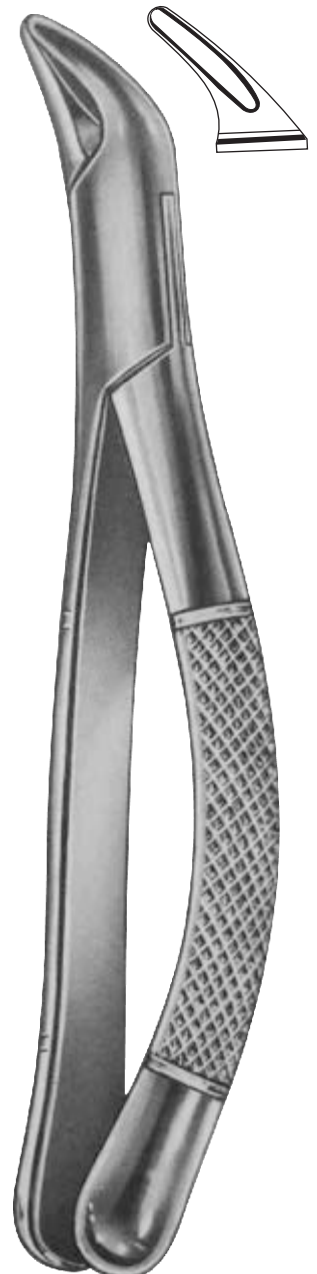

M-0137-151 S
Fig. 151 S
Cryer

Zahnzangen, amerikanische form
Extracting Forceps, american Pattern

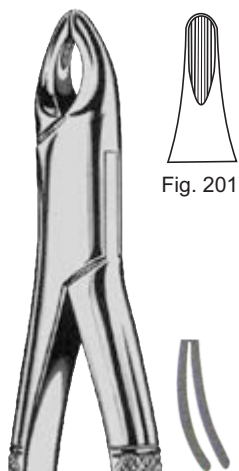

M-0138-201

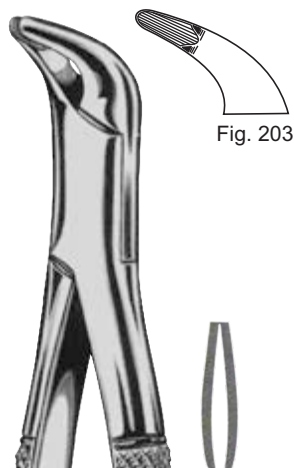

M-0139-203

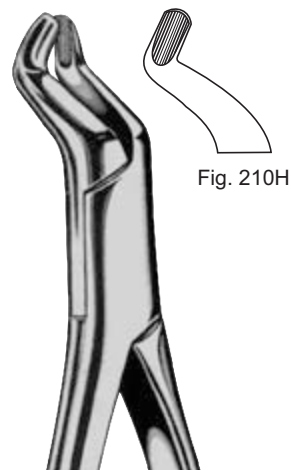

M-0140-210H

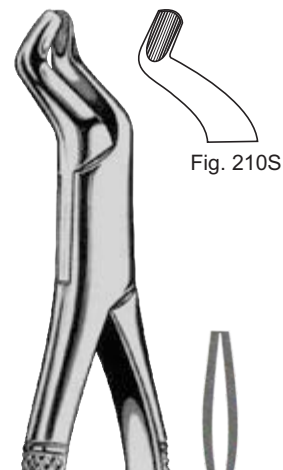

M-0140-210S

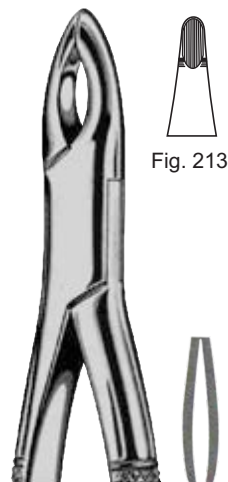

M-0141-213

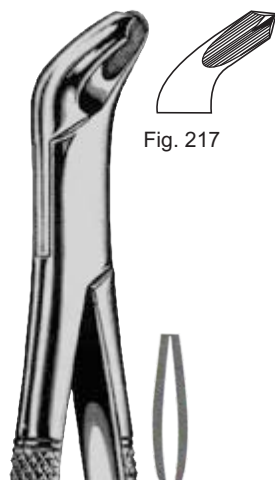

M-0142-217

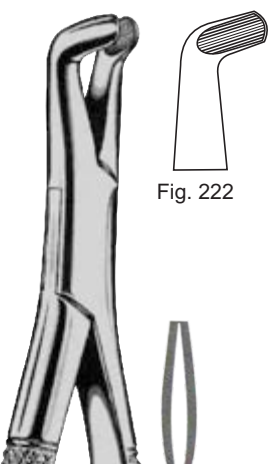

M-0143-222

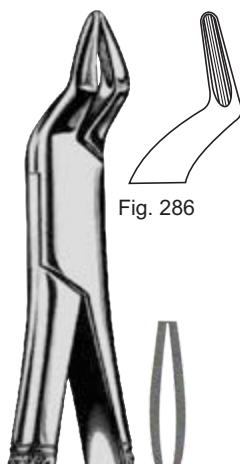

M-0144-286

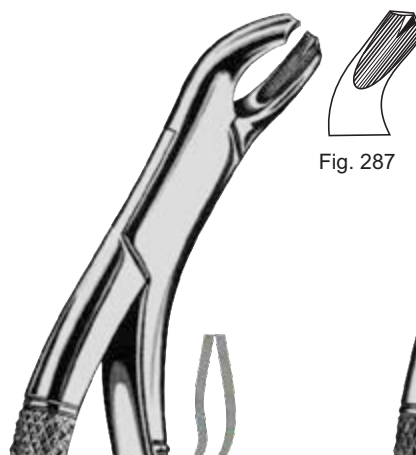

M-0145-287

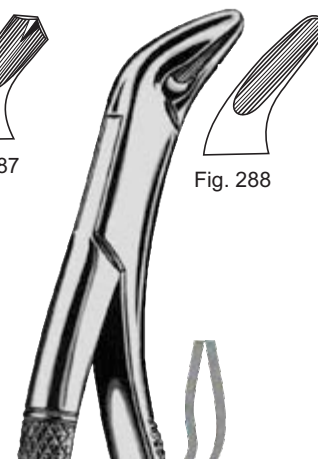

M-0146-287



M-0147-150AB

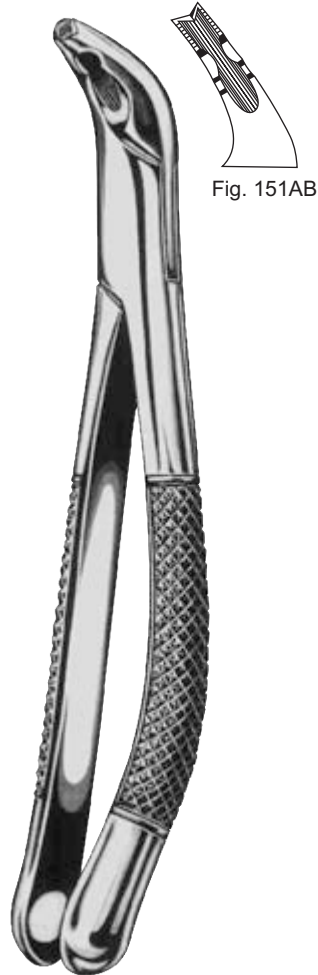

M-0148-151AB

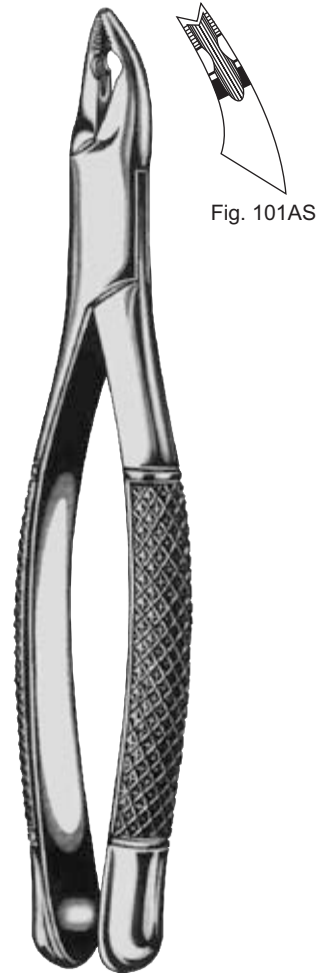

M-0149-101AS

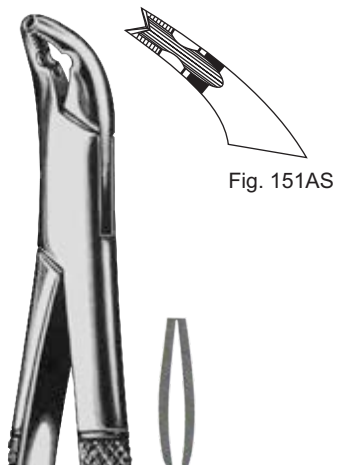

M-0150-151AS

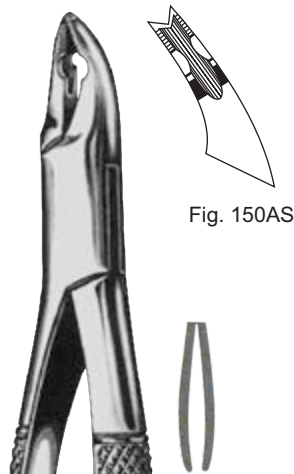

M-0150-150AS



M-0151-53RS

Zahnzangen, amerikanische form
Extracting Forceps, american Pattern

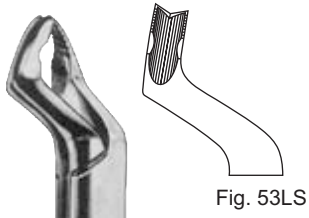

M-0152-53LS

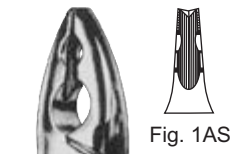

M-0153-1AS

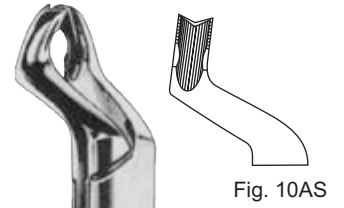

M-0154-10AS



M-0156-34AS

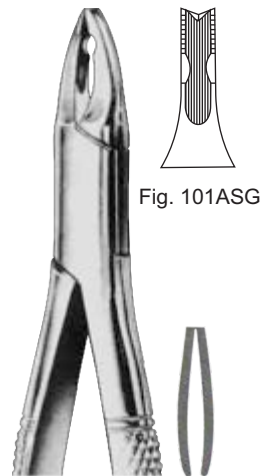

M-0157-101ASG



M-0158-103AS

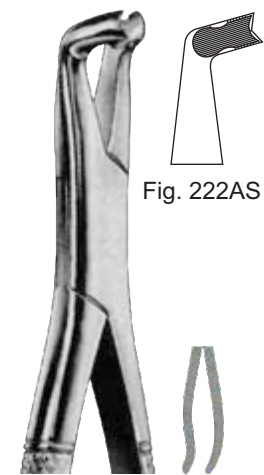

M-0159-222AS



M-0160-23S
 Fig. 23S
 untere Molaren
 lower molars



M-0161-23SK
 Fig. 23SK
 untere Molaren
 lower molars



M-0162-17
 Fig. 17SK
 untere Molaren
 lower molars



M-0163-150
 Fig. 150SK
 für obere Zähne und Wurzeln
 upper anteriors and roots

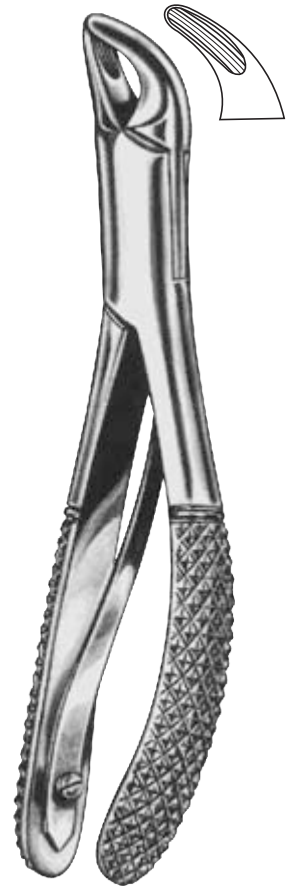

M-0164-151
 Fig. 151SK
 für untere Zähne und Wurzeln
 Lower anteriors and roots

With Diamond Dust Coating



M-0165-01
Fig. 01



M-0166-99
Fig. 99



M-0167-00

With Diamond Dust Coating



M-0168-17
Fig.17

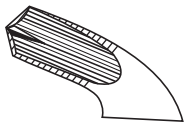

M-0169-53L
Fig.53L

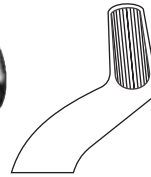

Fig. 53L



M-0169-53R
Fig.53R

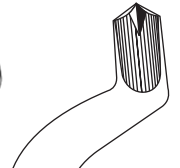

Fig. 53R

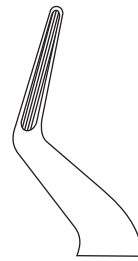
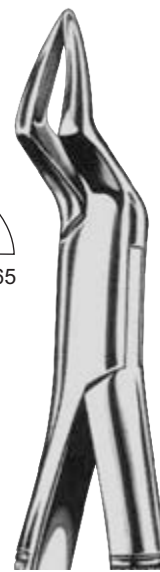

Fig. 65



M-0170-65
Fig.65



With Diamond Dust Coating



M-0171-69
Fig. 69
 Upper and Lower
 Fragments and Roots

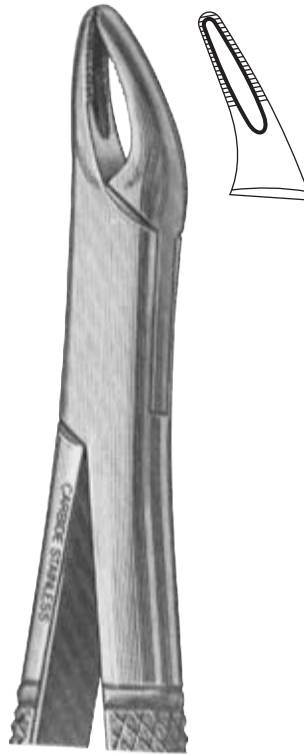

M-0172-150
Fig. 150
 Upper Incisors, Cuspids
 Bicuspid and Roots; Universal

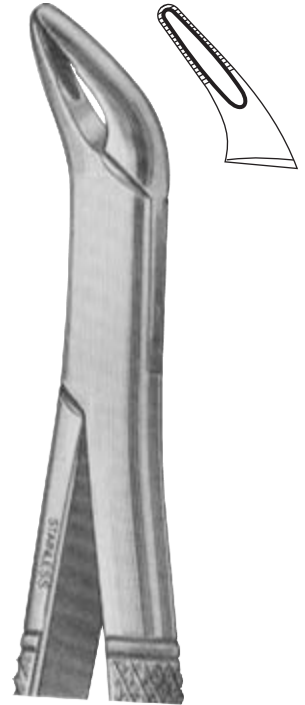

M-0173-151
Fig. 151
 Lower Incisors, Cuspids
 Bicuspid and Roots; Universal

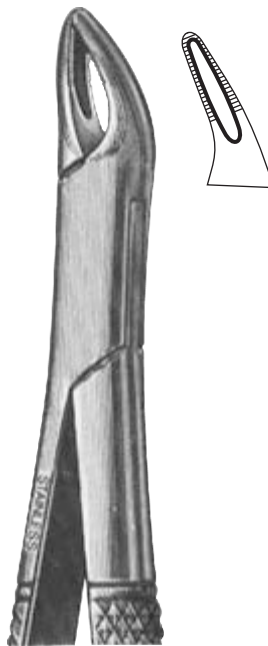
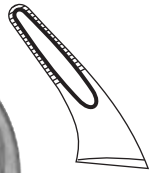

M-0172-150S
Fig. 150S
 Pedo, Upper Primary
 Teeth and Roots; Universal

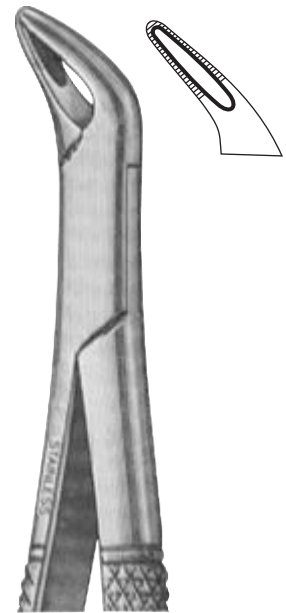

M-0173-151S
Fig. 151S
 Pedo, Lower Primary
 Teeth and Roots; Universal



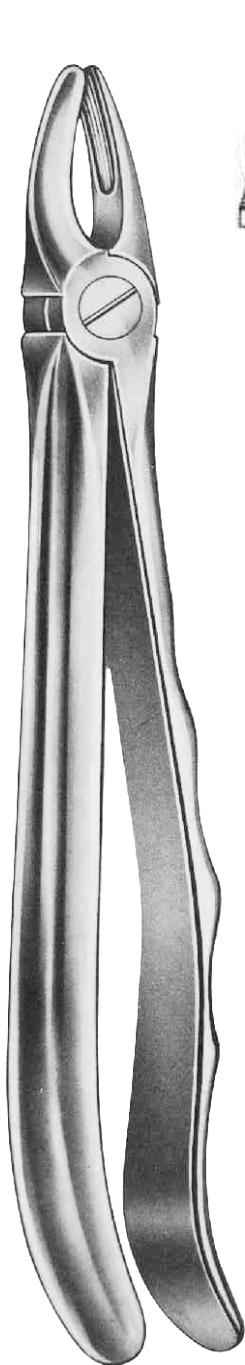

M-0175-01
Fig. 1
obere Schneide- und Eckzähne
upper incisors and bicuspid



M-0176-02
Fig. 2
Obere Schneide- und Eckzähne
upper incisors and bicuspid



M-0177-04
Fig. 4
Untere Schneide- und Eckzähne
lower incisors and bicuspid



M-0178-07
Fig. 7
Untere Prämolaren
lower premolars

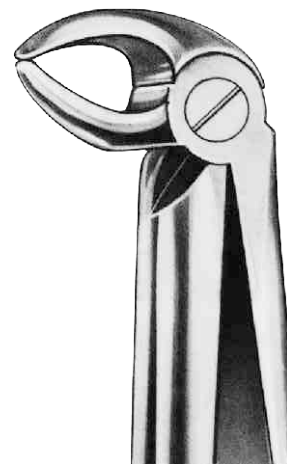

M-0179-13
Fig. 13
Untere Prämolaren
lower premolars





M-0180-17
 Fig. 17
 Obere Molaren, rechts
 upper molars, right

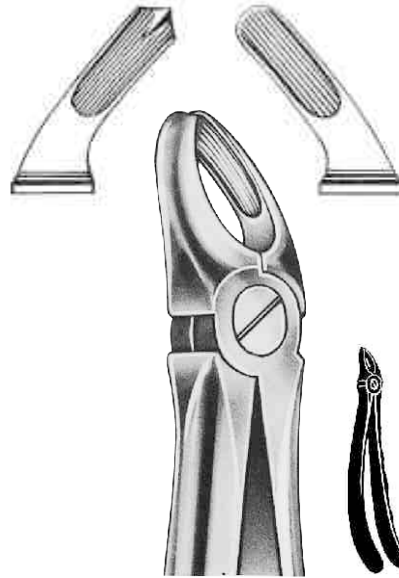

M-0181-18
 Fig. 18
 Obere Molaren, links
 upper molars, left

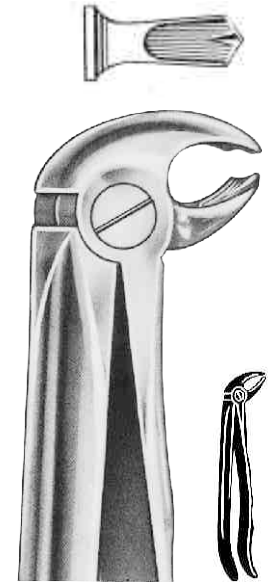

M-0182-22
 Fig. 22
 untere Molaren
 lower molars

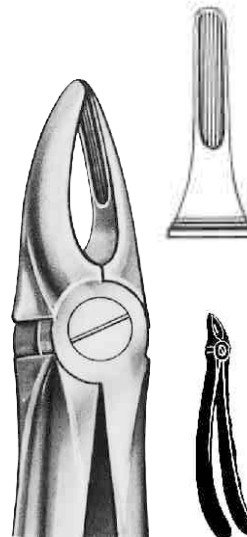

M-0183-29
 Fig. 29
 Obere Schneidezähne und Wurzeln
 upper incisors and roots



M-0184-33
 Fig. 33
 Untere Wurzeln
 lower roots

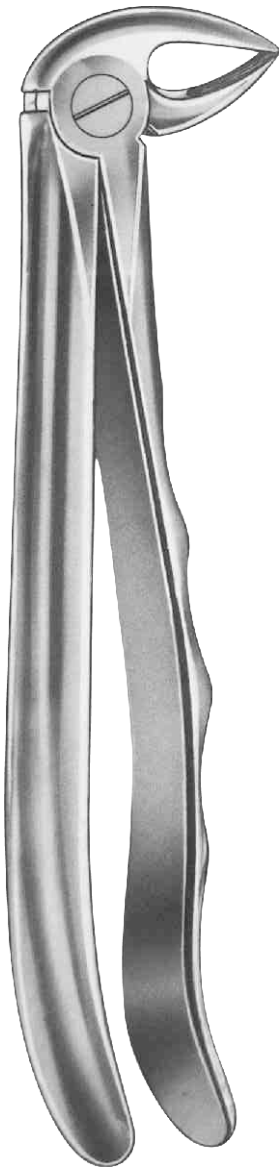

M-0185-33A
 Fig. 33A
 Untere Wurzeln
 lower roots



M-0186-33L
 Fig. 33L
 Untere Wurzeln
 lower roots

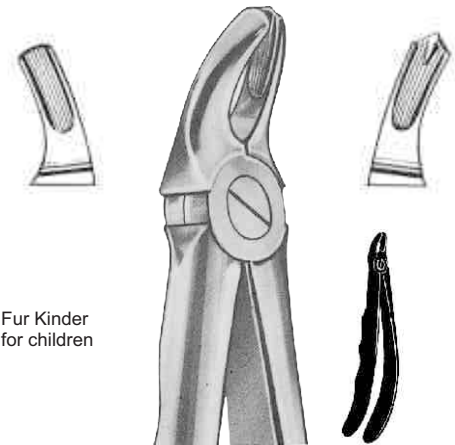

Für Kinder
 for children

M-0187-39L
 Fig. 39L

Obere Molaren und Prämolaren, links
 upper molars and premolars, left



Für Kinder
 for children

M-0187-39R
 Fig. 39R

Obere Molaren und Prämolaren, rechts
 upper molars and premolars, right

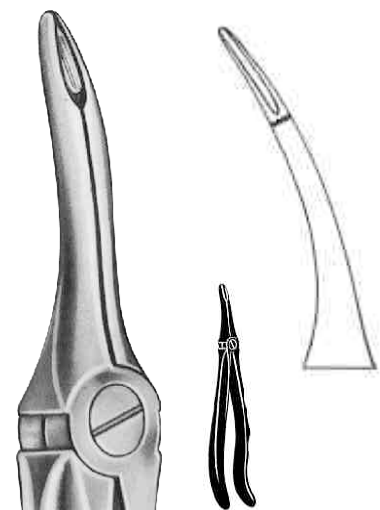

M-0188-49
 Fig. 49

Feine obere Wurzeln
 delicate upper roots

Zahnzangen, Englische Form
Extracting Forceps, English Pattern



M-0189-51
 Fig. 51
 Obere Wurzeln
 upper roots

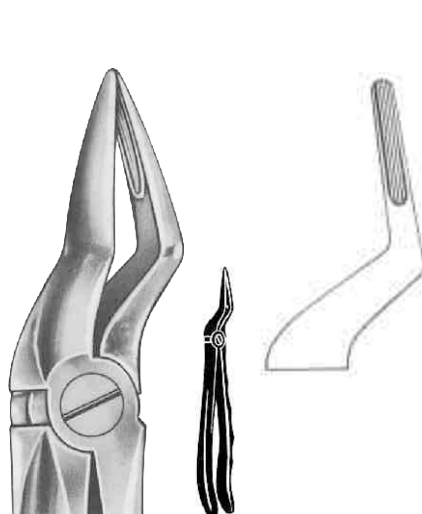

M-0189-51A
 Fig. 51A
 Obere Wurzeln
 upper roots

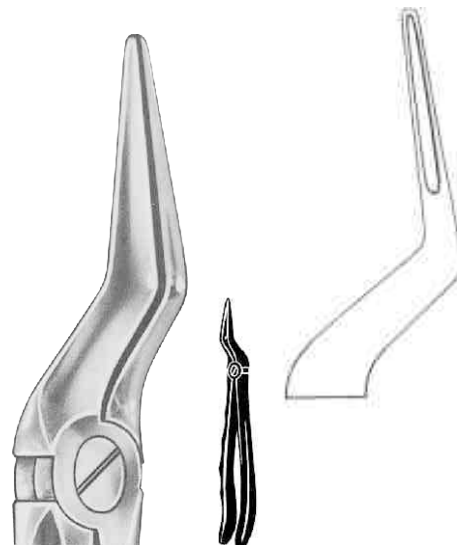

M-0189-51L
 Fig. 51 L
 Obere Wurzeln
 upper roots

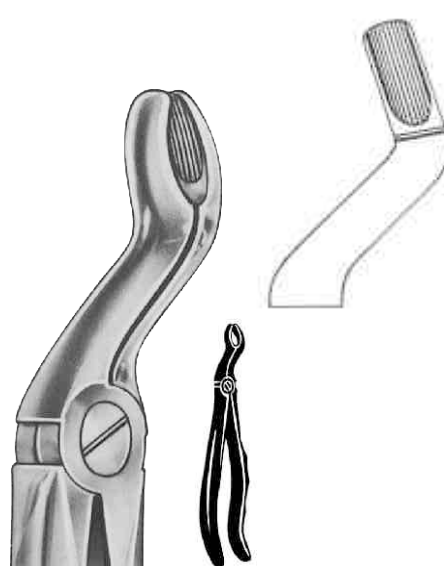

M-0190-67
 Fig. 67
 Obere Weisheitszähne
 upper wisdoms

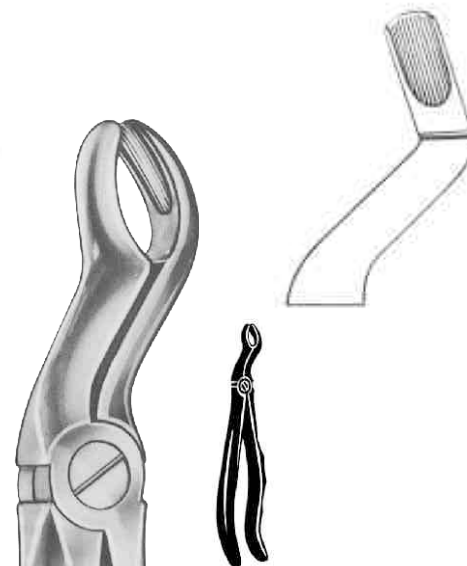

M-0190-67A
 Fig. 67 A
 Obere Weisheitszähne
 upper wisdoms



M-0191-73
Fig. 73
Untere Molaren
lower molars



M-0192-74
Fig. 74

Untere Wurzeln, Schneide- und Eckzähne
lower roots, incisors and bicuspid

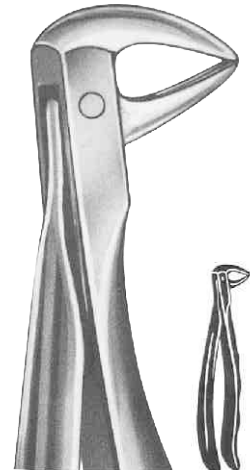

M-0193-74N
Fig. 74N

Untere Wurzeln, Schneide- und Eckzähne
lower roots, incisors and bicuspid

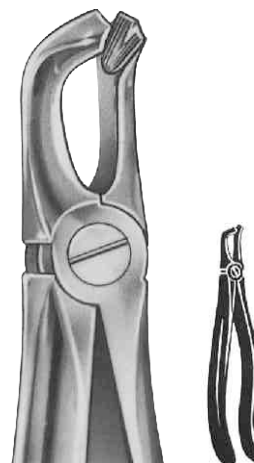

M-0194-79
Fig. 79

Untere Weisheitszähne
lower wisdoms

Wurzelsplitterzangen Root Splinter Forceps



M-0195-100
Witzel
obere Wurzeln
upper roots

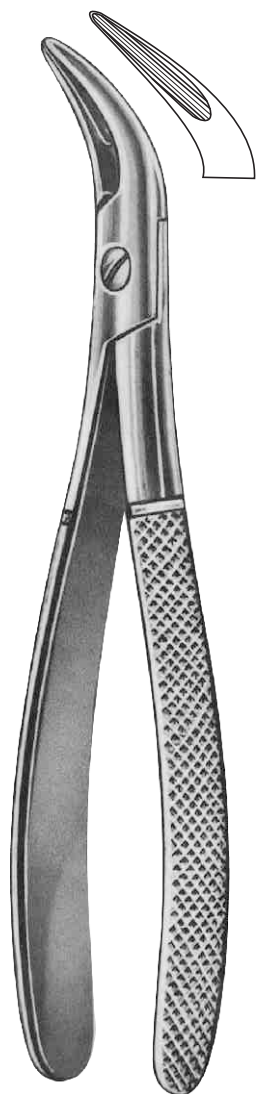

M-0195-101
Witzel
untere Wurzeln
lower roots



M-0196-16
Brom-Allen
16.5 cm



M-0197-01
Albrecht
16 cm



M-0197-02
Albrecht
16 cm



M-0198-01
140 mm
Nervkanalzange
nerve canal pliers

M-0198-02
140 mm
Nervkanalzange
nerve canal pliers



M-0199-01
Arthur
140 mm
Wurzelsplitterzangen
root fragments

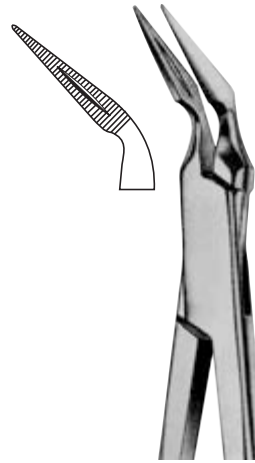

M-0200-02
Stieglitz
45°
140 mm
Wurzelsplitterzangen
root fragments

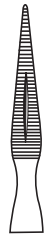

M-0200-01
Stieglitz
140 mm
Wurzelsplitterzangen
root fragments



M-0200-03
Stieglitz
90°
140 mm
Wurzelsplitterzangen
root fragments



M-0201-01
Ralks
150 mm
Wurzelsplitterzangen
root fragments

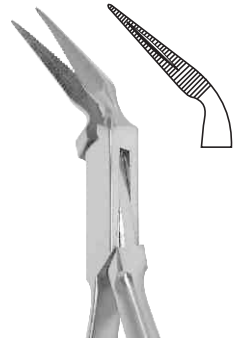

M-0201-02
Ralks
45°
150 mm
Wurzelsplitterzangen
root fragments



SEGITECH



www.segitech.net

| 2 mm |



M-0205-01
Fig. 1
Bein

| 3 mm |



M-0205-02
Fig. 2
Bein

| 4 mm |



M-0205-03
Fig. 3
Bein

| 2.5 mm |



M-0205-04
Fig. 4
Bein

| 3 mm |



M-0205-05
Fig. 5
Bein

| 4 mm |



M-0205-06
Fig. 6
Bein



M-0206-07
Fig. 7
White



M-0206-08
Fig. 8
White



M-0206-09
Fig. 9
White

| 5.0 mm |

| 4.0 mm |

| 3.5 mm |



M-0207-01
Fig.1
Bein



M-0207-02
Fig.2
Bein



M-0207-03
Fig.3
Bein

| 4.5 mm |

| 3.5 mm |

| 3.5 mm |

| 4.5 mm |



M-0208-01
Fig.1



M-0208-02
Fig. 2



M-0208-03
Fig. 3



M-0208-04
Fig. 4



Bein



M-0209-00
Fig. 0
Bein



M-0209-01
Fig. 1
Bein



M-0209-02
Fig. 2
Bein



M-0209-03
Fig. 3
Bein



M-0209-04
Fig. 4
Bein



M-0209-05
Fig. 5
Bein



M-0209-06
Fig. 6
Bein



Bein



M-0210-01
Fig. 1
Bein

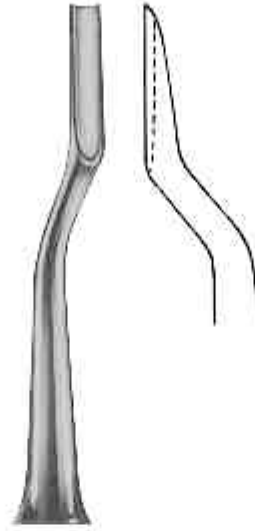

M-0210-02
Fig. 2
Bein



M-0210-03
Fig. 3
Bein



M-0210-04
Fig. 4
Bein

**Wurzelheber
Root Elevators**



M-0211-301
Apical 301



M-0211-302
Apical 302



M-0211-303
Apical 303



M-0211-304
Apical 304



M-0211-12A
Apical 12A



M-0212-34S
Seldin 34S



M-0212-34
Seldin 34



M-0213-00



M-0214-01
Flohr



M-0214-02
Flohr



M-0214-03
Flohr



M-0215-03
3 Seldin



M-0216-01



M-0217-3A
3A Cryer



M-0218-02
2 Seldin



M-0219-12
12 Cryer



M-022005
5 Seldin



M-0221-00
Crane Pick



M-0222-00



M-0223-00
Flohr



M-0223-1L
1L Seldin

M-0223-1R
1R Seldin



M-0223-4L
4L Seldin

M-0223-4R
4R Seldin



M-0224-00

M-0225-00



M-0226-27
27 Cryer

M-0226-28
28 Cryer



M-0227-27S
27S Cryer

M-0227-28S
28S Cryer



M-0228-00

M-0229-00



M-0230-00

M-0231-00



M-0232-01
Miller 1

M-0232-02
Miller 2



M-0232-03
Miller 3

M-0232-04
Miller 4



M-0233-01
Fig. 1



M-0236-06
Fig. 6



M-0237-15
Fig. 15



M-0238-16
Fig. 16



M-0234-02
Fig. 2



M-0235-03
Fig. 3



M-0239-01
Fig. 1
Apical



M-0239-02
Fig. 2
Apical



M-0239-03
Fig. 3
Apical



M-0239-04
Fig. 4
Apical



M-0239-05
Fig. 5
Apical



**M-0240-01
Seldin**



**M-0240-02
Seldin**



**M-0241-01L
Seldin**



**M-0241-02R
Seldin**



**M-0242-00
White**



**M-0243-01
Witer**



**M-0243-02
Witer**

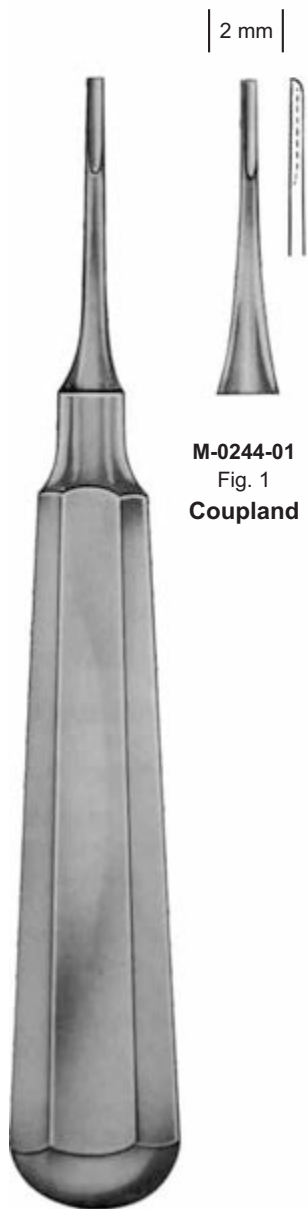

Coupland

| 2 mm |



M-0244-01
Fig. 1
Coupland

| 2.5 mm |



M-0244-02
Fig. 2
Coupland

| 3 mm |



M-0244-03
Fig. 3
Coupland



Cryer



M-0245-01
Fig. 1
Cryer



M-0245-02
Fig. 2
Cryer



M-0246-01
Fig. 1
Schlemmer



M-0246-02
Fig. 2
Schlemmer



M-0247-01
Fig. 1



M-0247-02
Fig. 2



M-0247-03
Fig. 3



Kopp



**M-0248-01
Fig. 1
Kopp**



**M-0248-02
Fig. 2
Kopp**



**M-0248-03
Fig. 3
Kopp**



**M-0248-04
Fig. 4
Kopp**



**M-0248-05
Fig. 5
Kopp**



**M-0248-06
Fig. 6
Kopp**



Kopp



**M-0249-01
Fig. 1
Kopp**



**M-0249-02
Fig. 2
Kopp**



**M-0249-03
Fig. 3
Kopp**



**M-0249-04
Fig. 4
Kopp**

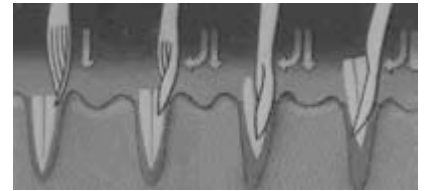

M-0250-00
Fig.0



M-0250-01
Fig.1



M-0250-02
Fig.2



M-0250-03
Fig.4



M-0250-04
Fig.5



M-0251-01
Fig.1
Kopp



M-0251-02
Fig. 2
Kopp



M-0251-03
Fig. 3
Kopp



M-0251-04
Fig. 4
Kopp

Wurzelheber Root Elevators



| 4.5 mm |



M-0252-01
Fig.1
Hylin

| 3.2 mm |



M-0252-02
Fig.2
Hylin

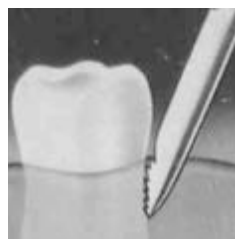

| 2.5 mm |



M-0253-01
Fig.1
Lindo-Levien

| 3.5 mm |



M-0253-02
Fig.2
Lindo-Levien

| 4.5 mm |



M-0253-03
Fig.3
Lindo-Levien

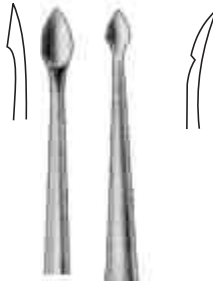

**M-0254-02
Bernard**
Fig. 2
4 mm



**M-0254-3L
Bernard**
Fig. 3L
4 mm



**M-0254-4R
Bernard**
Fig. 4R
4 mm



**M-0254-01
Bernard**
Fig. 1
4 mm



**M-0255-01
Lindo-Levin**
3 mm



**M-0255-02
Lindo-Levin**
3.5 mm



**M-0255-03
Lindo-Levin**
4 mm

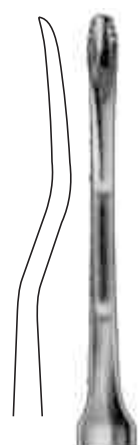

**M-0255-04
Lindo-Levin**
3 mm

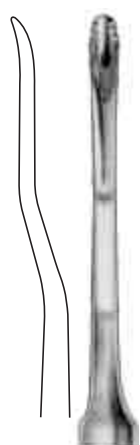

**M-0255-05
Lindo-Levin**
3 mm



M-0256-01
Fig. 1
Warwick-James



M-0256-02
Fig. 2
Warwick-James



M-0256-03
Fig. 3
Warwick-James



M-0257-01
Fig. 1
Coleman



M-0257-02
Fig. 2
Read
5 mm



M-0257-3L
Fig. 3L
Coleman
London Hospital



M-0257-4R
Fig. 4R
Coleman
London Hospital



M-0258-01
Ott



M-0259-01
Fig. 1
Chompret



M-0259-02
Fig. 2
Chompret



M-0259-03
Fig. 3
Chompret



M-0259-04
Fig. 4
Chompret



M-0260-00
Pott



M-0260-01
Fig. 1
Pott



M-0260-02
Fig. 2
Pott

**Wurzelheber
Root Elevators**



M-0261-01
Fig. 1
Flohr



M-0261-02
Fig. 2
Flohr



M-0261-03
Fig. 3
Flohr



M-0262-00
Apical



Unterkiefer rechts
lower jaw, right side

Unterkiefer links
lower jaw, left side



M-0263-01



M-0264-01

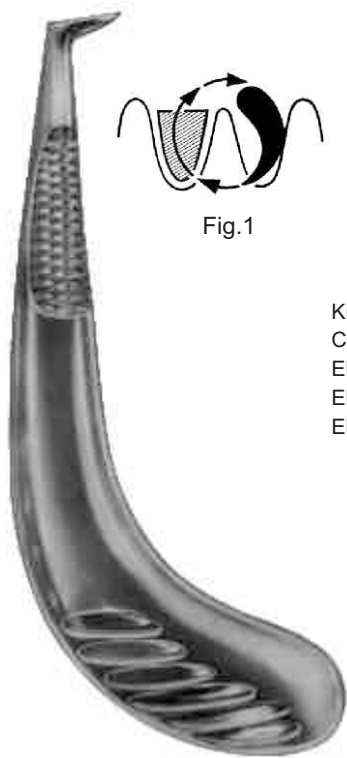

**M-0265-01
Septum Lancets**

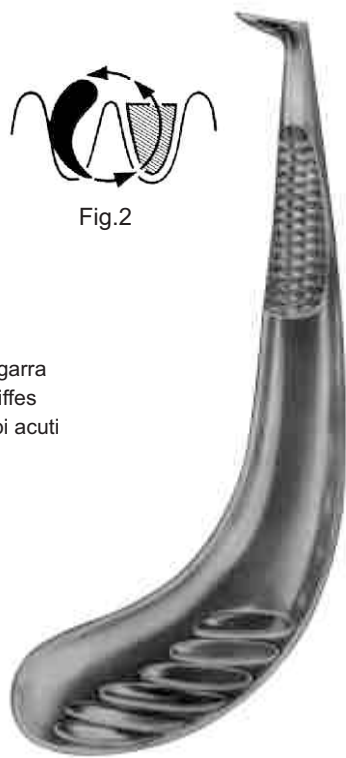

**M-0265-02
Septum Lancets**

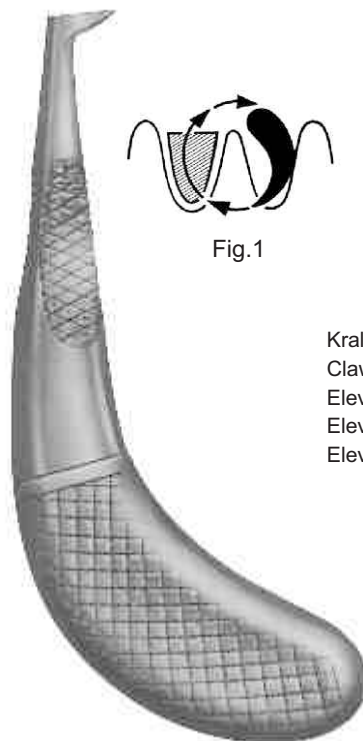

Fig.1

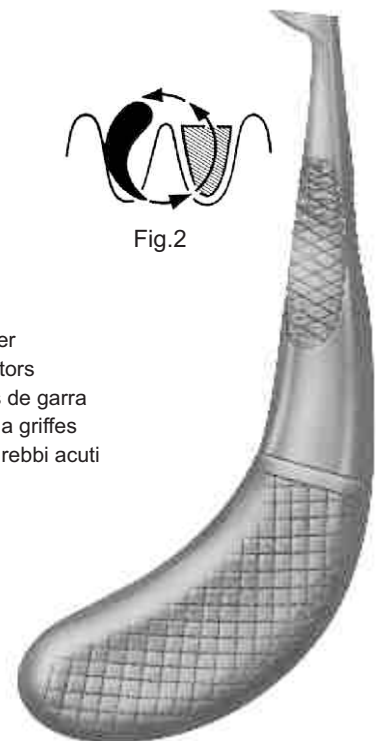

Fig.2

Krallenheber
Claw elevators
Elevadores de garra
Elevateurs a griffes
Elevatori a rebbi acuti



**M-0266-01
Krallenheber**



**M-0266-02
Krallenheber**

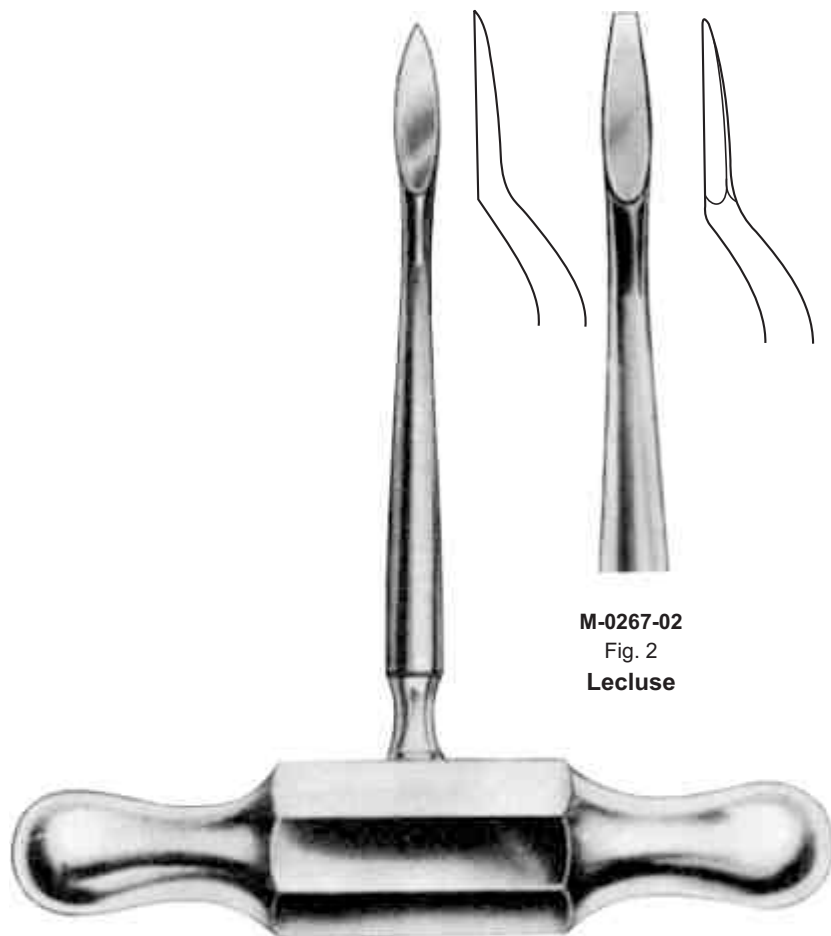

Fig.1



Fig.2

Krallenheber
Claw elevators
Elevadores de garra
Elevateurs a griffes
Elevatori a rebbi acuti



M-0267-01
Fig. 1
Lecluse

M-0267-02
Fig. 2
Lecluse



M-0268-01
Fig. 1
Lecluse

M-0268-02
Fig. 2
Lecluse



M-0269-1L
Fig. 1L
Winter



M-0269-1R
Fig. 1R
Winter



M-0269-2L
Fig. 2L
Winter



M-0269-2R
Fig. 2R
Winter



M-0269-11L
Fig. 11L
Winter



M-0269-11R
Fig. 11R
Winter

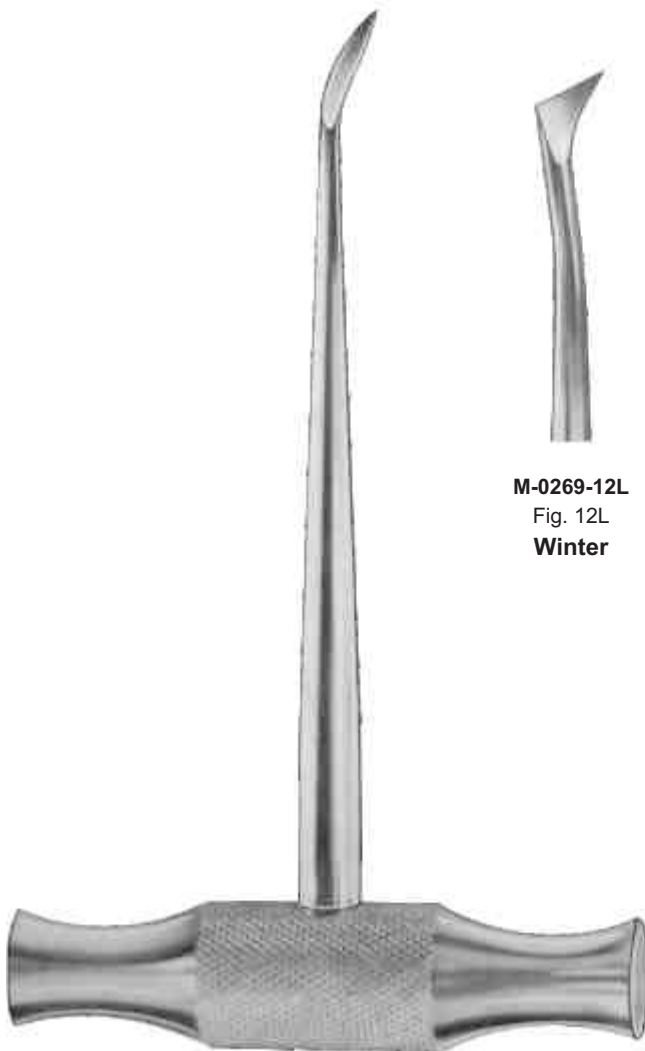

Winter



M-0269-12L
Fig. 12L
Winter



M-0269-12R
Fig. 12R
Winter



M-0269-13L
Fig. 13L
Winter



M-0269-13R
Fig. 13R
Winter



M-0269-14L
Fig. 14L
Winter



M-0269-14R
Fig. 14R
Winter



M-0270-01L
Fig. 1L
Barry



M-0270-02R
Fig. 2R
Barry



M-0270-03L
Fig. 3L
Barry



M-0270-04R
Fig. 4R
Barry



Barry



M-0270-11L
Fig. 11L
Barry



M-0270-12R
Fig. 12R
Barry



M-0270-17
Fig. 17
Barry



M-0270-18
Fig. 18
Barry



M-0271-02
Fig. MD-2
Mead



M-0271-03
Fig. MD-3
Mead



M-0271-04
Fig. MD-4
Mead



M-0271-5A
Fig. MD-5A
Mead



M-0271-6A
Fig. MD-6A
Mead



M-0271-7A
Fig. MD-7A
Mead



M-0271-8A
Fig. MD-8A
Mead

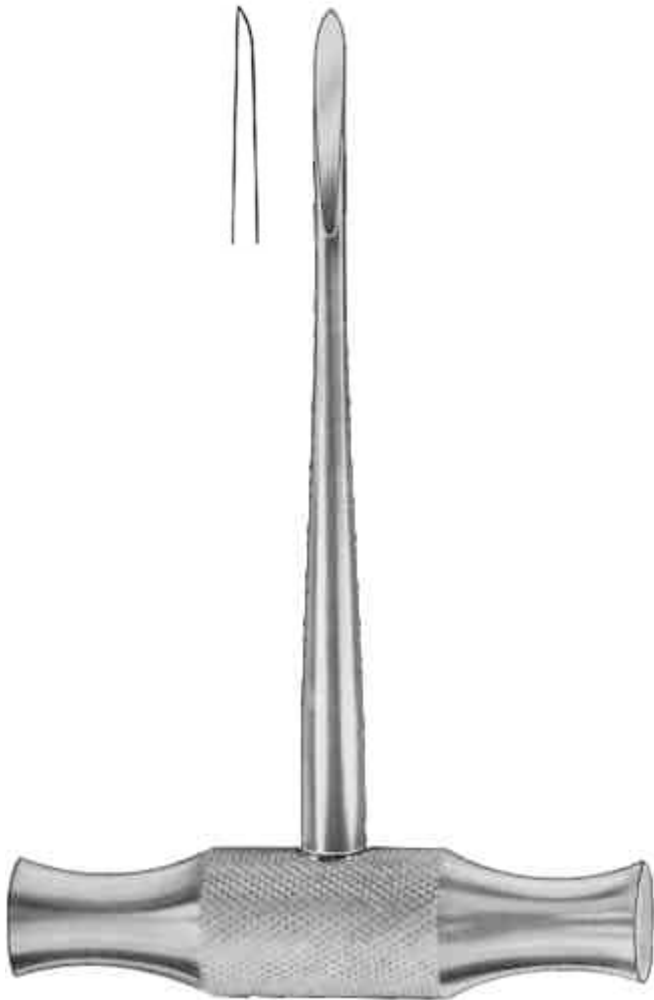

M-0271-01
Fig. MD-1
Mead



M-0271-9A
Fig. MD-9A
Mead



M-0271-10A
Fig. MD-10A
Mead



M-0271-11
Fig. MD-11
Mead



M-0272-01
Fig. 1
Heidbrink



M-0272-02
Fig. 2
Heidbrink
Left



M-0272-03
Fig. 3
Heidbrink
Right

1.8 mm



M-0273-01
Fig. 1
Heidbrink

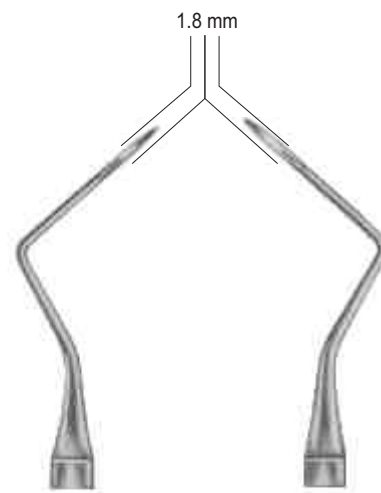

M-0273-02
Fig. 2
Heidbrink

M-0273-03
Fig. 3
Heidbrink



Heidbrink



M-0274-01
1.2 mm
Heidbrink



M-0274-02
1.5 mm
Heidbrink



M-0274-03
1.8 mm
Heidbrink



M-0274-04
2.5 mm
Heidbrink



M-0275-00
11 cm



M-0276-00
Fig. 0



M-0276-01
Fig. 1



M-0276-02
Fig. 2



M-0276-03
Fig. 3



M-0276-04
Fig. 4



M-0276-05
Fig. 5

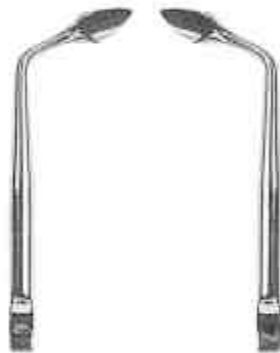

M-0276-06
Fig. 6



M-0276-07
Fig. 7



M-0276-08
Fig. 8



M-0276-09
Fig. 9



M-0276-11
Fig. 11



M-0276-21
Fig. 21



M-0276-22
Fig. 22



M-0276-23
Fig. 23



M-0276-24
Fig. 24



M-0276-25
Fig. 25



M-0276-26
Fig. 26



M-0276-27
Fig. 27



M-0276-28
Fig. 28



M-0276-29
Fig. 29



SEGITECH



www.segitech.net

TUNGSTEN CARBIDE INSERTS



Goldmann-Fox
M-0280-13 straight
M-0281-13 curved
13 cm

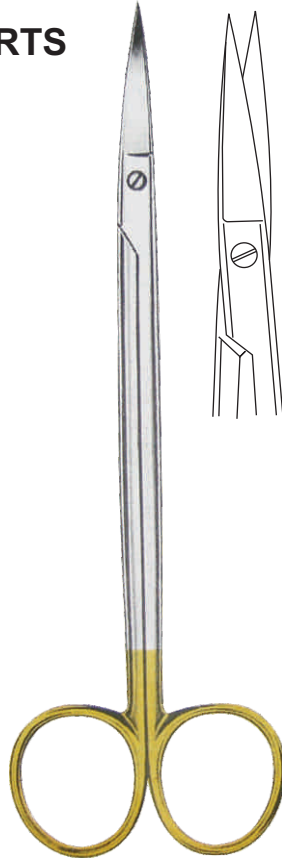

Kelly
M-0282-16 straight
M-0283-16 curved
16 cm



La Grange
M-0284-11
11 cm

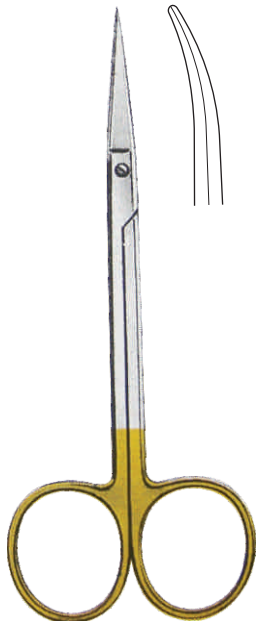

Iris
M-0285-11 straight
M-0286-11 curved
13 cm

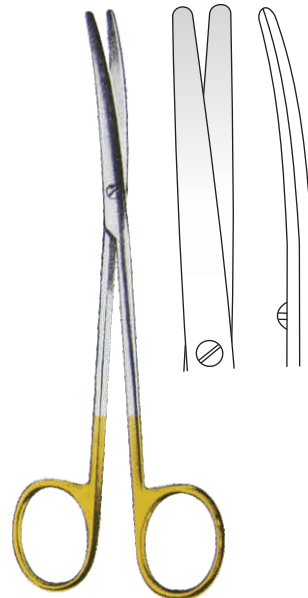

Metzenbaum
M-0287-14 straight
M-0288-14 curved
14.5 cm

Zahnfleischscheren
Gum Scissors



M-0289-11
Iris
11 cm



M-0289-01
11 cm
straight

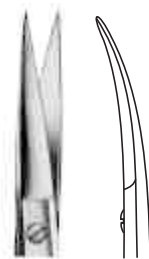

M-0289-02
11 cm
curved



M-0289-03
11 cm
sickle-shaped



M-0289-04
11 cm
angled



M-0290-12
Quinby
12.5 cm



straight



M-0291-12
Quinby
12.5 cm



curved



M-0292-12
Neumann
12 cm



curved

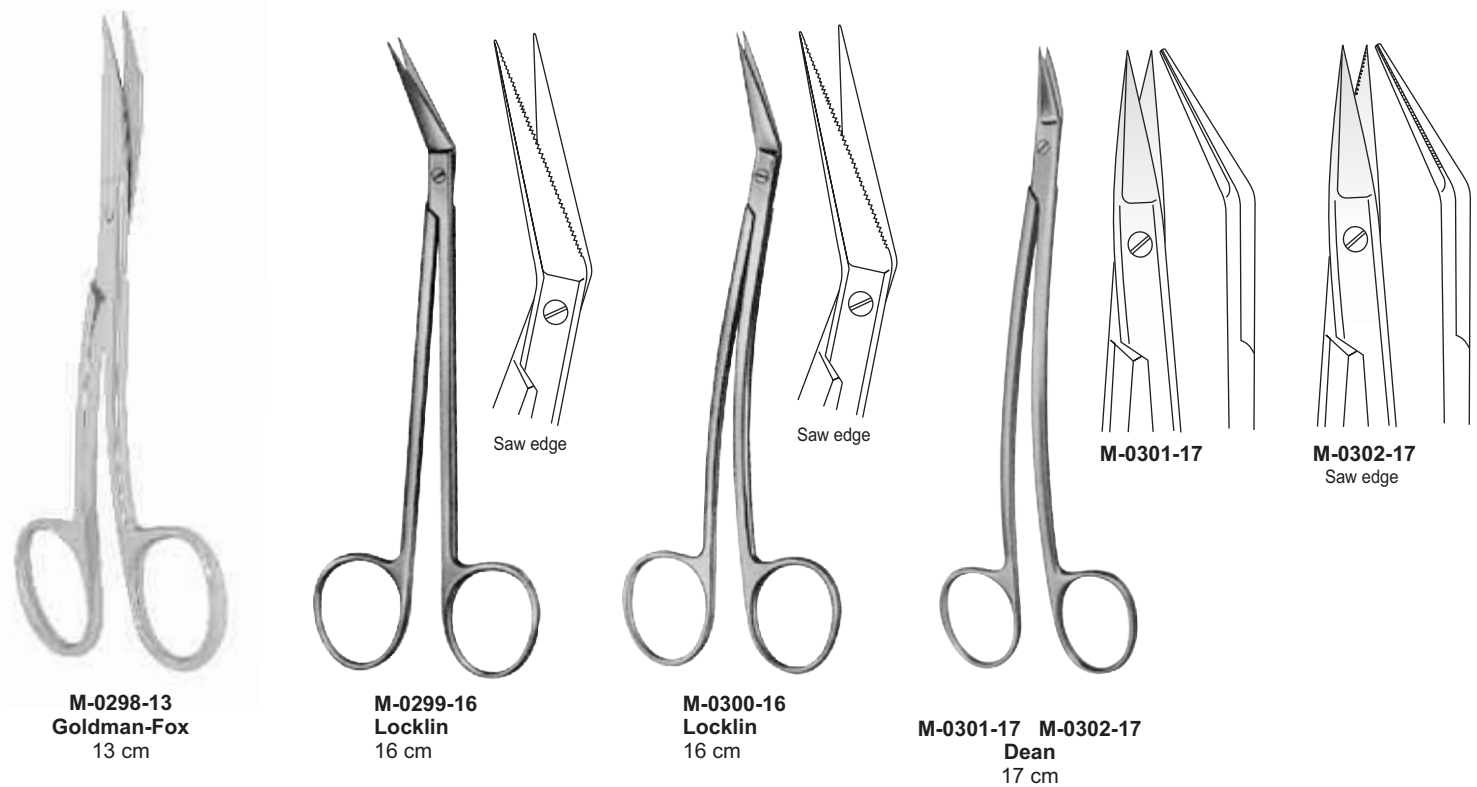
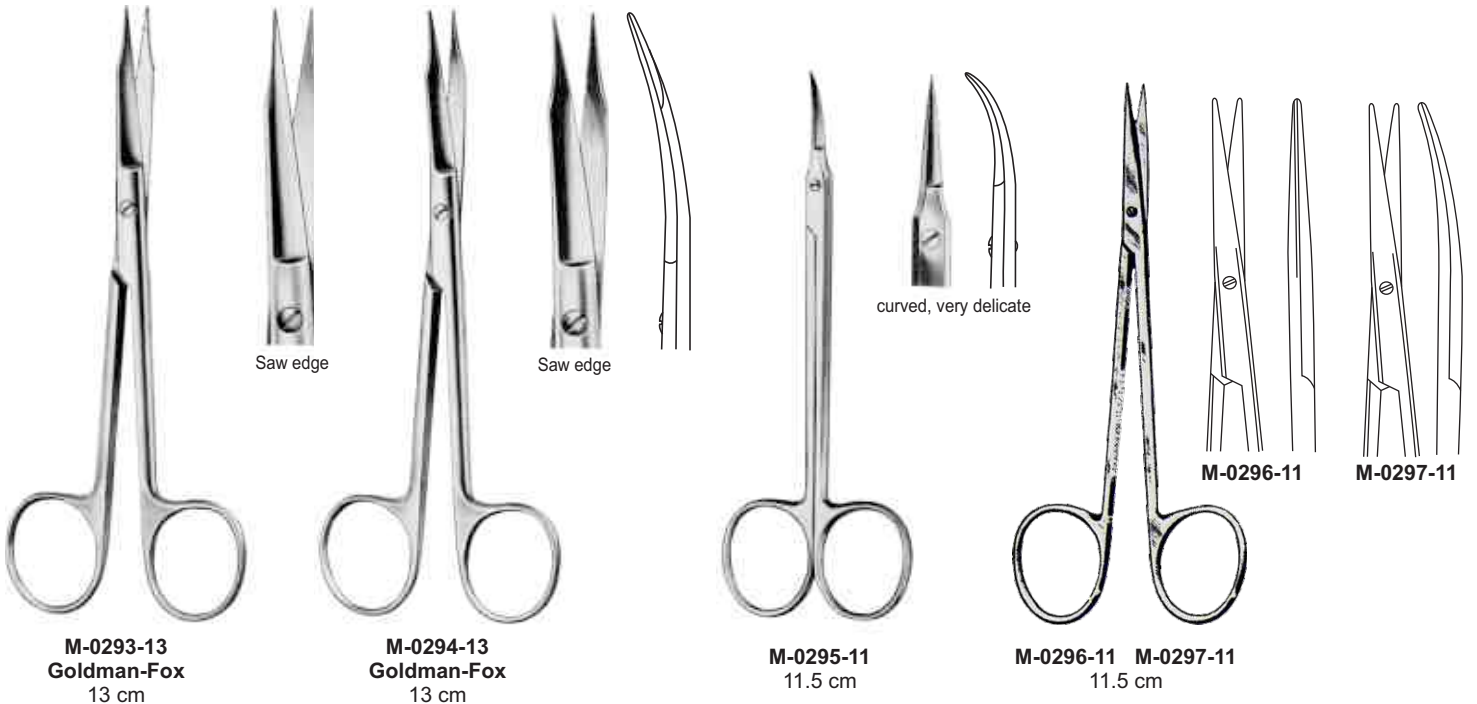

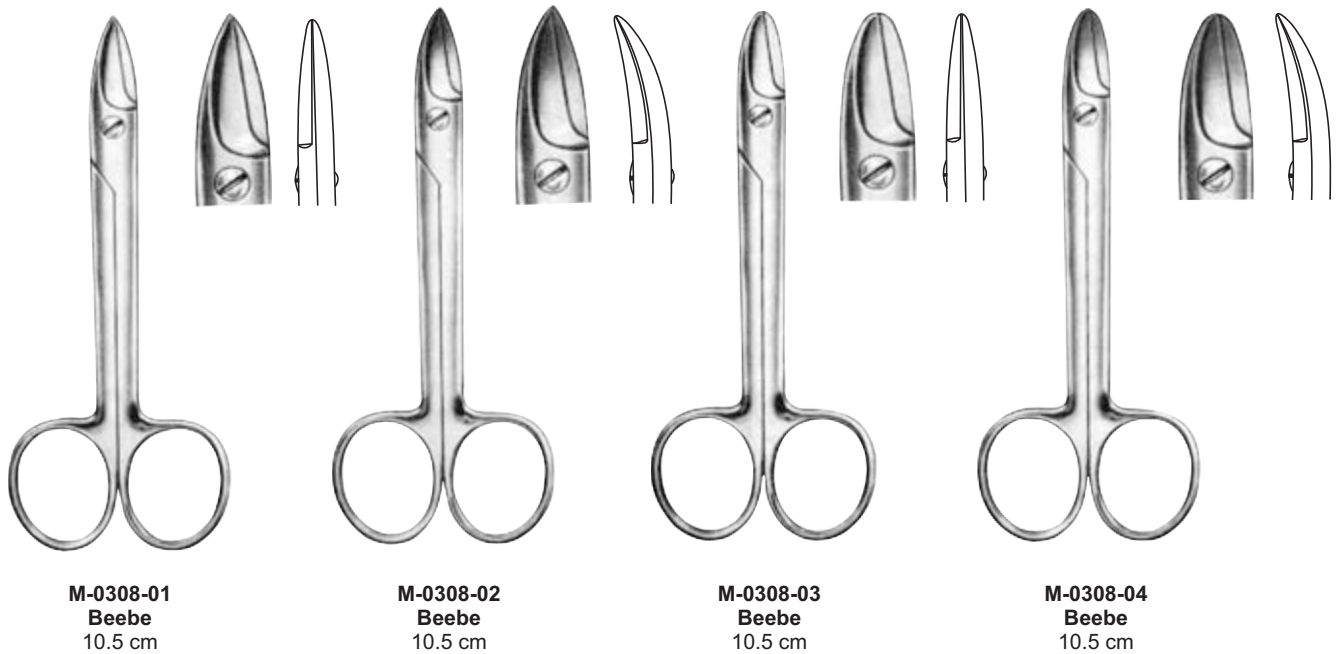

Lister

M-0309-01 14 cm
M-0309-02 18 cm
M-0309-03 20 cm

Standard s/s

M-0310-01 14 cm
M-0310-02 15 cm
M-0310-03 18 cm

Standard B/B

M-0311-01 14 cm
M-0311-02 15 cm
M-0311-03 18 cm

Standard S/B

M-0312-01 14 cm
M-0312-02 15 cm
M-0312-03 18 cm

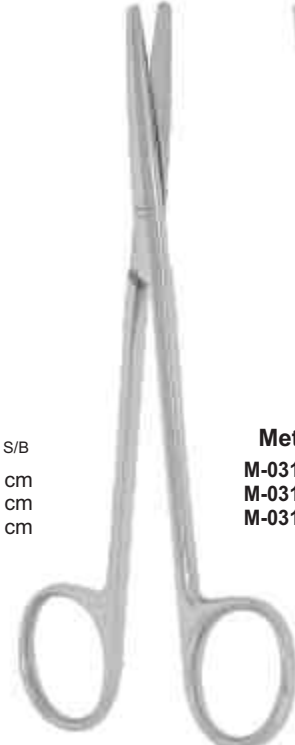
Metzenbaum

M-0313-01 14 cm
M-0313-02 15 cm
M-0313-03 18 cm



curved

Metzenbaum

M-0314-01 14 cm
M-0314-01 15 cm
M-0314-01 18 cm



M-0315-01
Martin-Northbent
 laterally curved



straight

M-0316-01
Spencer
 10.5 cm

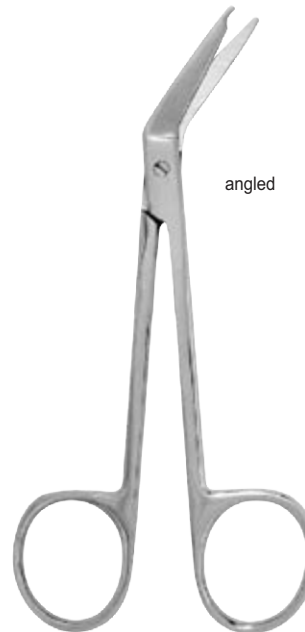

angled

M-0316-02
Spencer
 11.5 cm

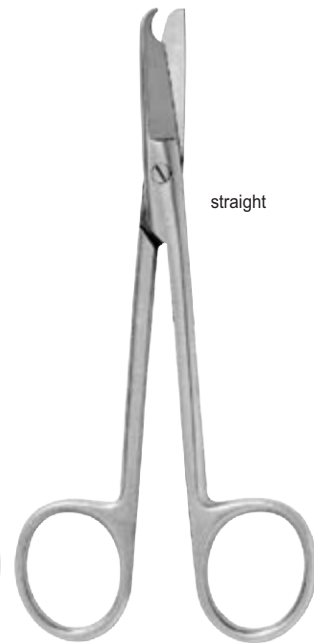

straight

M-0317-13
Littauer
 13 cm



M-0318-12
Noyes
12 cm

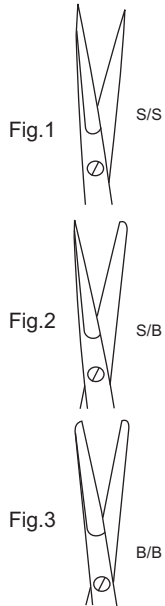

M-0319-11
11 cm

Wescott



M-0320-11
11 cm



M-0321-00

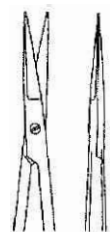

M-0321-15
15 cm

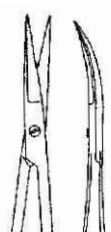

M-0322-15
15 cm

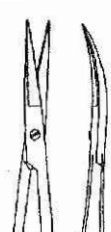

M-0323-15
15 cm

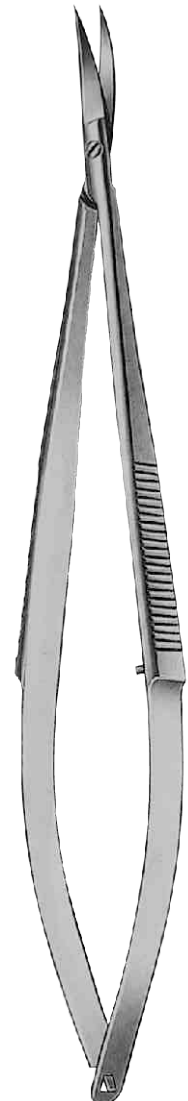

M-0324-15
Castroviejo
15 cm



M-0325-15
15 cm

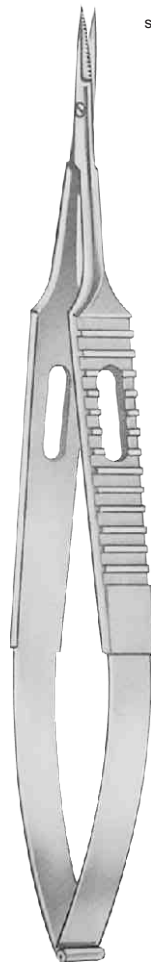

M-0326-12
12.5 cm

serrated



M-0327-12
12.5 cm
curved

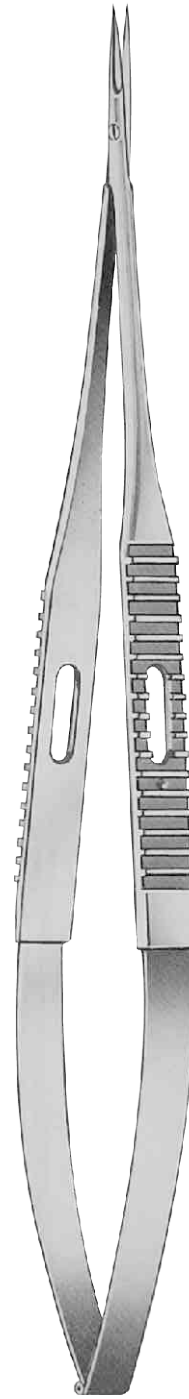

M-0328-18
18 cm



M-0329-18
18 cm
curved

Nadelhalter Needle Holders



All needle Holders are available with TC and without TC



M-0330-12
Collier
12.5 cm



M-0331-12
Webster
12.5 cm

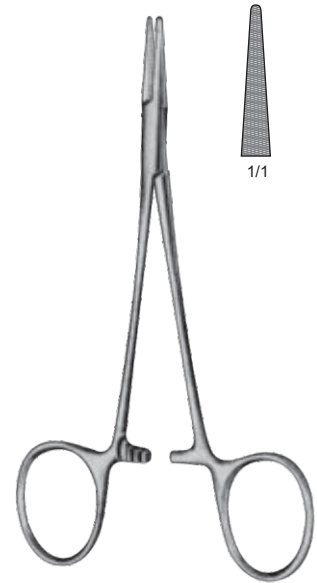

M-0332-13
Halsey
13.5 cm



M-0333-14
Baumgartner
14 cm



Mayo-Hegar

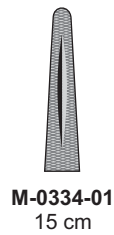

M-0334-01
15 cm

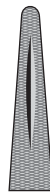

M-0334-02
18 cm

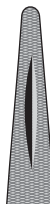

M-0334-03
20 cm



Mayo-Hegar
M-0335-09



M-0335-01
16 cm 6 1/4"



M-0335-02
18.5 cm 7 1/4"



M-0335-03
20.5 cm 8"
Delicate Patterns



M-0336-12
Wright (Derf)
12.5 cm



M-0337-18
Toennis
18 cm



M-0339-18
Langenbeck
18 cm

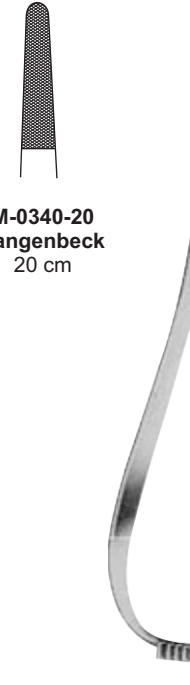

M-0340-20
Langenbeck
20 cm



M-0341-14 14 cm
M-0342-17 17 cm
Mathieu



M-0343-12
Boynton
12 cm

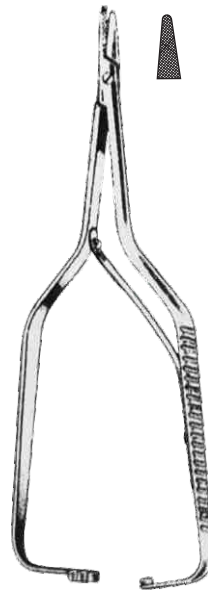

M-0344-12
Boynton
12 cm



M-0345-14
Mathieu
14 cm



M-0346-14
14 cm



M-0347-17
17 cm



M-0348-20
20 cm 8"

Nadelhalter Needle Holders

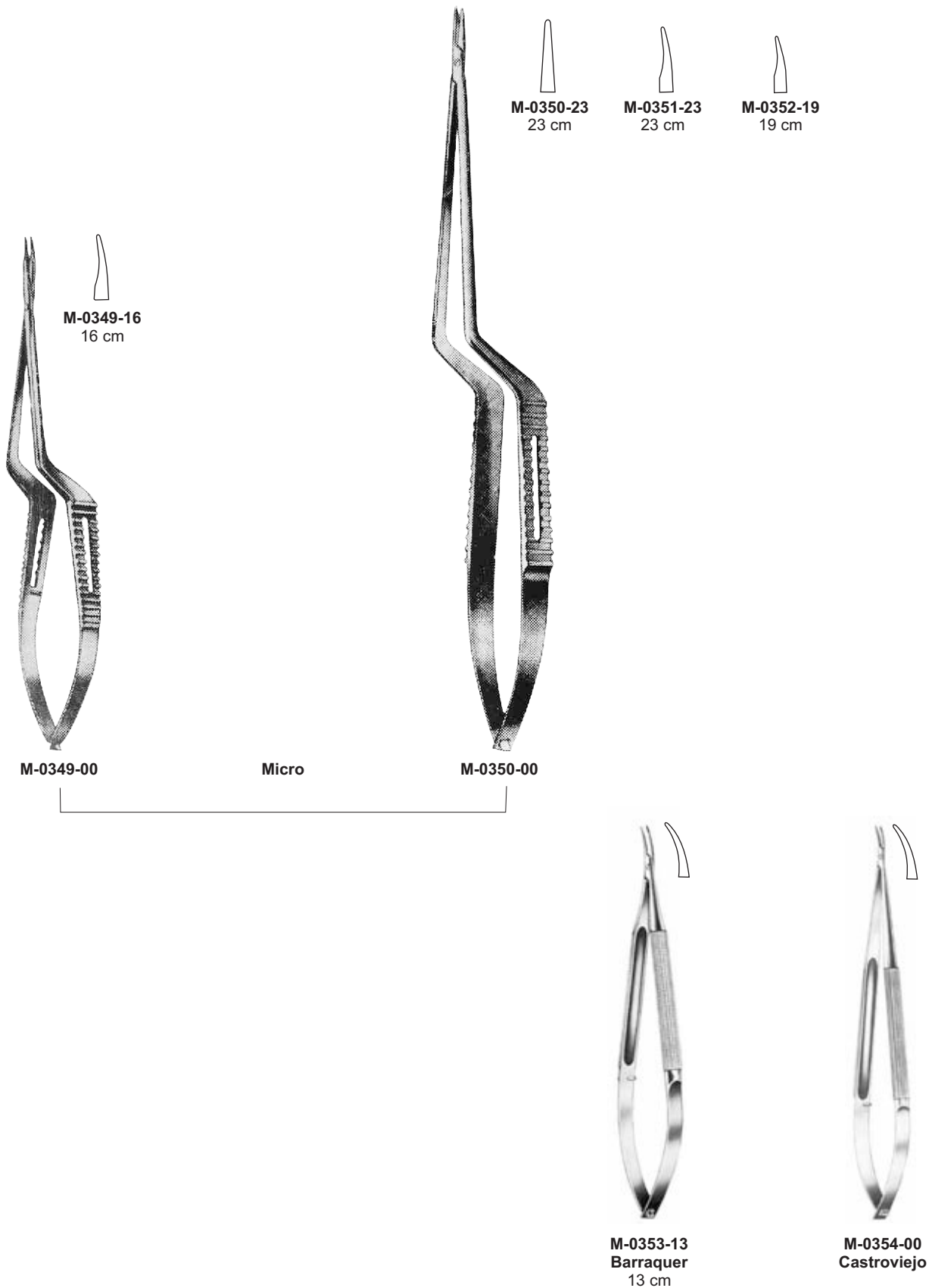

All needle Holders are available with TC

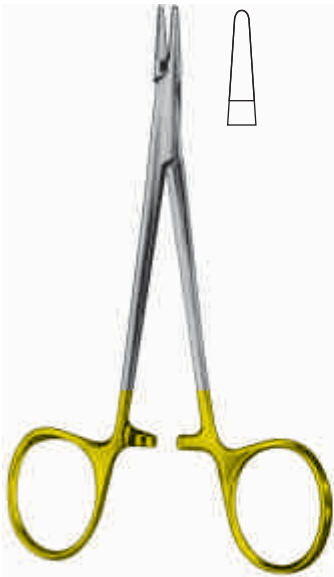

**M-0355-12
Webster
12.5 cm**



**M-0356-12
Wright (Derf)
12.5 cm**



**M-0357-13
Halsey
13.5 cm**



**M-0358-14
Baumgartner "TC"
14 cm**



**M-0359-01 14 cm
M-0359-02 18 cm
M-0359-03 20 cm
Mayo-Hegar**

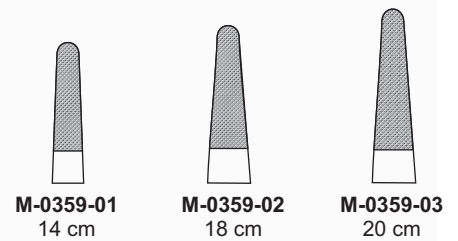

**M-0359-01
14 cm**

**M-0359-02
18 cm**

**M-0359-03
20 cm**

Nadelhalter Needle Holders



All needle Holders are available with TC and without TC



M-0360-15
Baby-Crile-Wood
15 cm



M-0361-15
Crile-Wood "TC"
15 cm



M-0362-01 14 cm
M-0362-02 17 cm
Olsen-Hegar

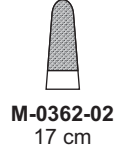
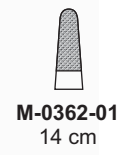

M-0363-14
Gillies-slim
14.5 cm



M-0364-15
Gillies
15.5 cm





M-0365-00
Hegar-Baumgartner
14cm/5½"

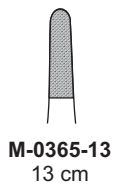

M-0366-00
Martin

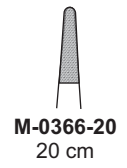
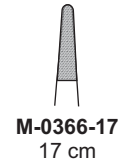
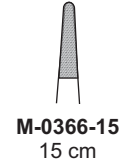

M-0367-15 15 cm
M-0367-18 18 cm
Ryder (French Eye)

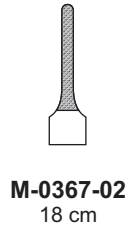
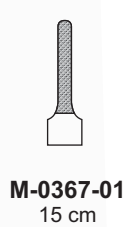

M-0368-18 18cm/7"
M-0368-26 26cm/10¼"
Sarot



M-0369-00
Universal

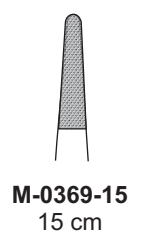
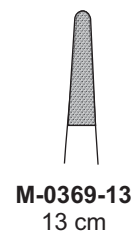

Nadelhalter Needle Holders

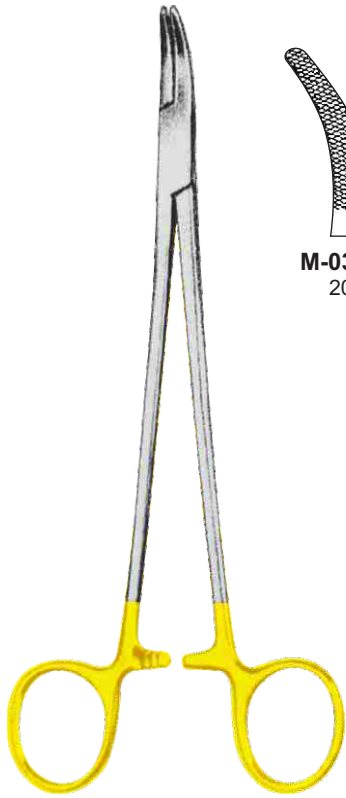

M-0370-00
Mayo Hegar (Heaney)



M-0370-20
20 cm



M-0370-24
24 cm



M-0370-26
26 cm



M-0371-00
Mayo Hegar



M-0371-16
16 cm



M-0371-18
18 cm



M-0371-20
20 cm



M-0371-24
24 cm



M-0371-26
26 cm



M-0371-30
30 cm

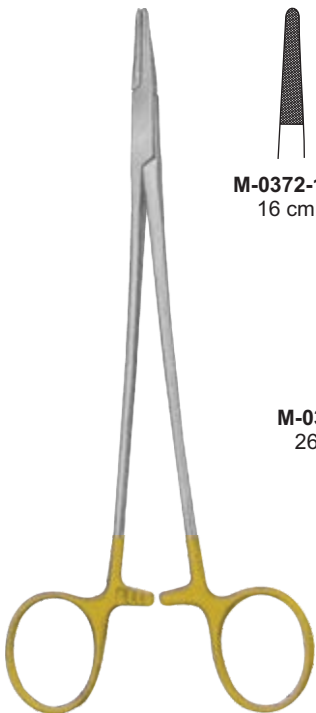

M-0372-00
DeBakey



M-0372-16
16 cm



M-0372-20
20 cm



M-0372-23
23 cm



M-0372-26
26 cm



M-0372-31
31m



M-0372-37
37cm



Arruga
16 cm/6¼"



M-0373-16
16 cm



M-0374-16
16 cm



M-0375-12
Boynton
12 cm/4¾"



M-0376-14 14 cm
M-0376-17 17 cm
M-0376-20 20 cm
M-0376-24 24 cm
Mathieu



M-0377-17
17 cm
Lichtenberg



M-0377-01
14 cm

M-0377-02
17 cm

M-0377-03
20 cm

M-0377-01 14 cm
M-0377-02 17 cm
M-0377-03 20 cm
Mathieu-Kocher



M-0378-18
Toennis
18 cm



M-0378-00
Langenbeck, Leicht

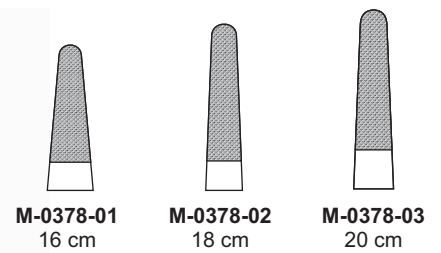

M-0378-01
16 cm

M-0378-02
18 cm

M-0378-03
20 cm

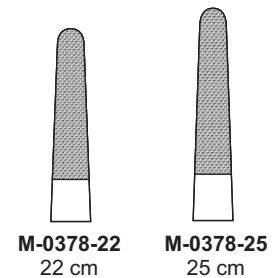

M-0378-22
22 cm

M-0378-25
25 cm

Nadelhalter Needle Holders



M-0379-01 17 cm
M-0379-02 20 cm
Mathieu-Kocher



M-0380-00
Vascular

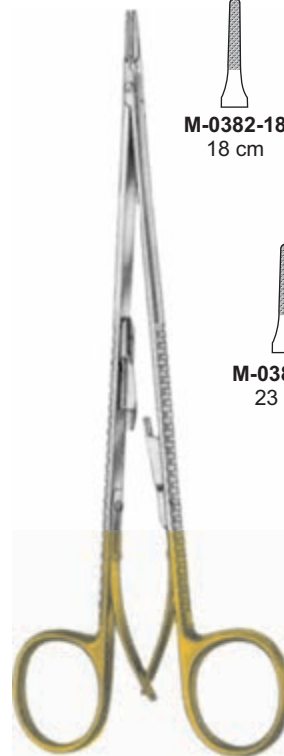
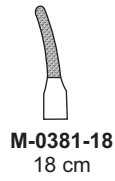

M-0382-00
Dietrich

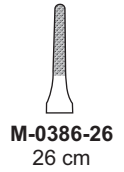
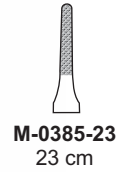
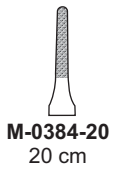
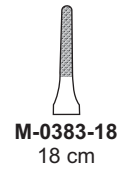
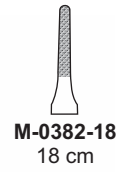

M-0387-00

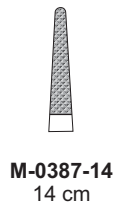

M-0388-18
Hepp-Schiedel
18cm/7"

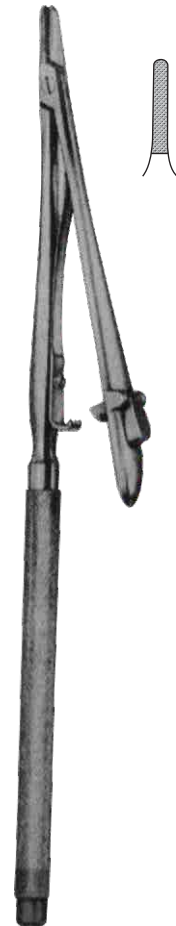

M-0389-22
Pott-Smith
22 cm

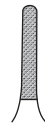

All needle Holders are available with TC and without TC



M-0390-01
Castroviejo
13 cm

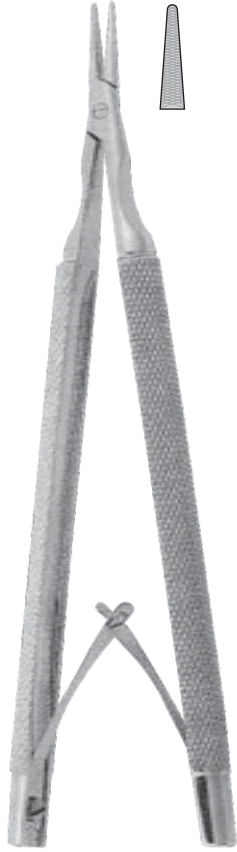

M-0390-02
Castroviejo
13 cm



M-0391-12
Castroviejo "TC"
12 cm



M-0392-12
Castroviejo Barraquer
12 cm



M-0393-18
Castroviejo Micro "TC"
18 cm

**Mikro-Nadelhalter
Micro Needle Holders**



All needle Holders are available with TC and without TC

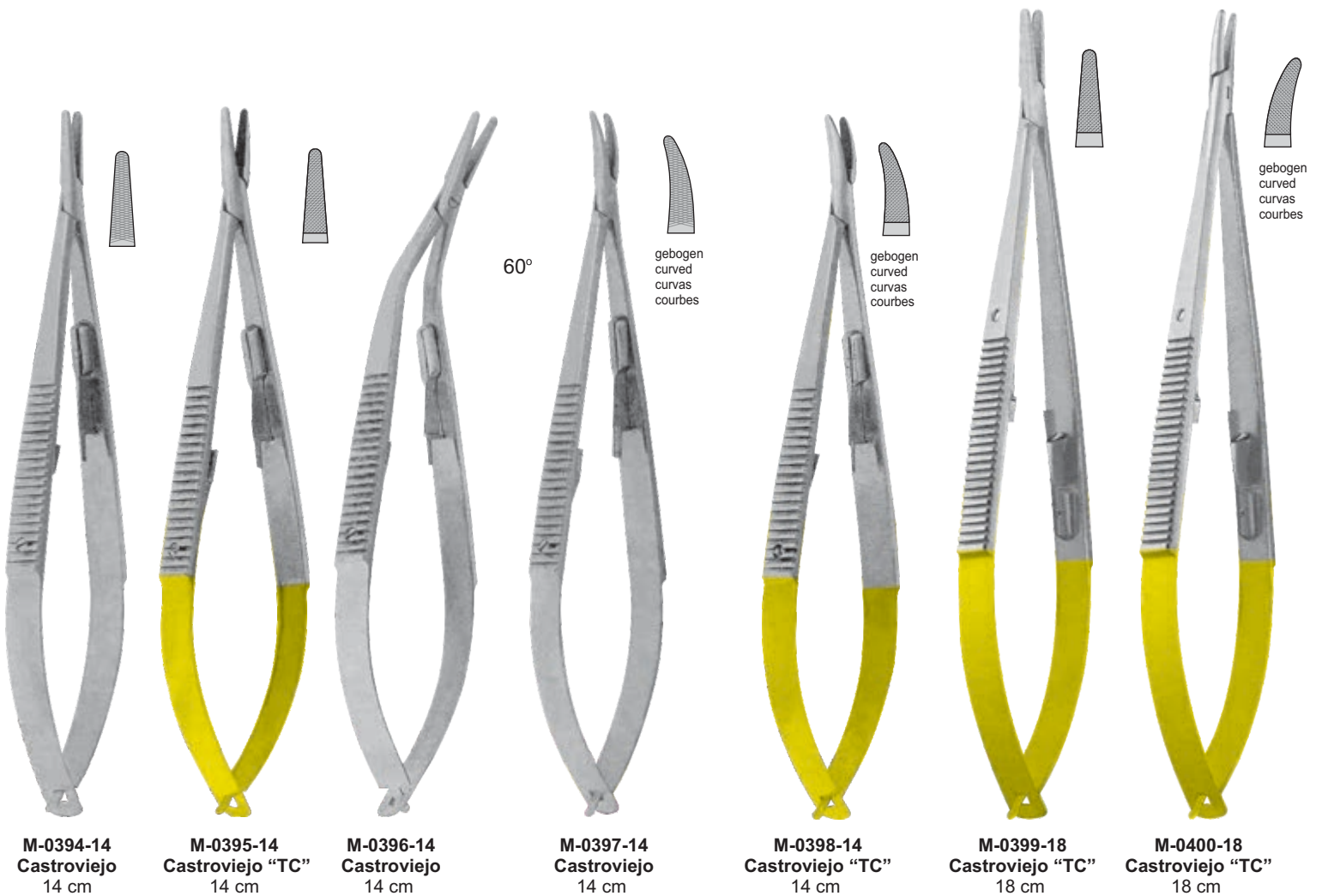

- 1- Probe double end
- 2- Grooved director with tongue tie
- 3- B.P. Handle No 3
- 4- B.P. Handle No 4
- 5- Thum dressing forceps serrated 14 cm
- 6- Tissue forceps 14 cm 1x2 teeth
- 7- Mayo hegar needle holder 14 cm
- 8- Operating scissor 14 cm SH/BL str
- 9- Operating scissor 14 cm SH/BL cvd

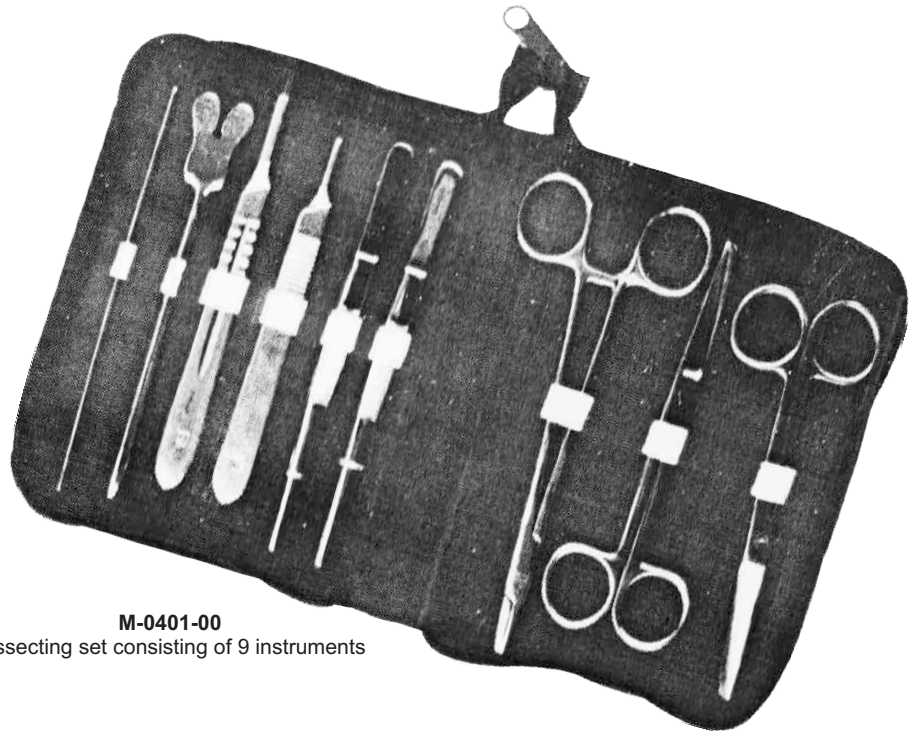

M-0401-00
Dissecting set consisting of 9 instruments

- 1- Probe double end
- 2- Grooved director with tongue tie
- 3- B.P. Handle No 3
- 4- B.P. Handle No 4
- 5- Thum dressing forceps serrated 14 cm
- 6- Tissue forceps 14 cm 1x2 teeth
- 7- Mayo hegar needle holder 14 cm
- 8- Operating scissor 14 cm SH/BL str
- 9- Operating scissor 14 cm SH/BL cvd
- 10- Kelly forceps 14 cm str
- 11- Kelly forceps 14 cm cvd

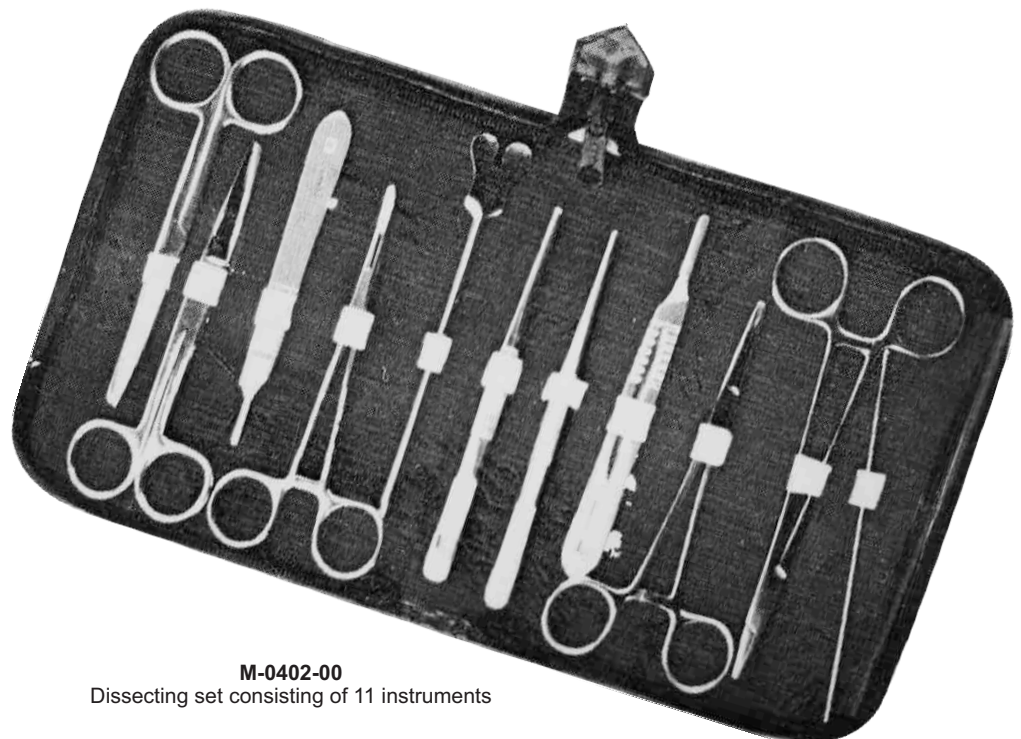

M-0402-00
Dissecting set consisting of 11 instruments

**Arterienklemmen
Hemostatic Forceps**



**M-0403-14
Pean
14 cm**



straight

curved

**M-0405-01 14 cm
M-0405-02 16 cm
M-0405-03 18 cm
Kocher**



straight

curved

**M-0407-01 14 cm
M-0407-02 16 cm
M-0407-03 18 cm
Rochester-Pean**

**M-0404-01 14 cm
M-0404-02 16 cm
M-0404-03 18 cm
Kocher**

**M-0406-01 14 cm
M-0406-02 16 cm
M-0406-03 18 cm
Rochester-Pean**

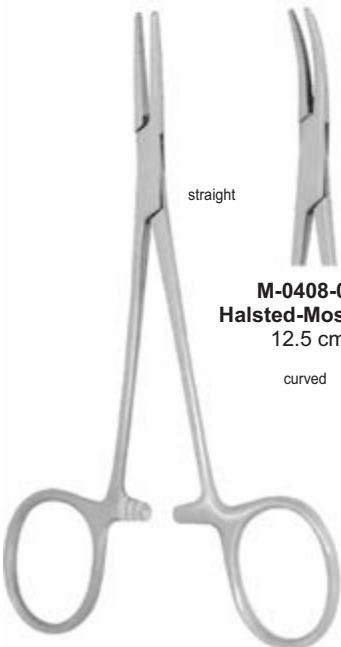

straight

curved

**M-0408-02
Halsted-Mosquito
12.5 cm**

**M-0408-01
Halsted-Mosquito
12.5 cm**



**M-0409-12
12.5 cm
straight**

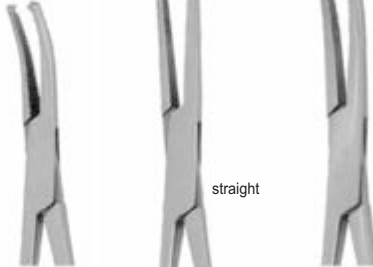

**M-0410-12
12.5 cm
curved**

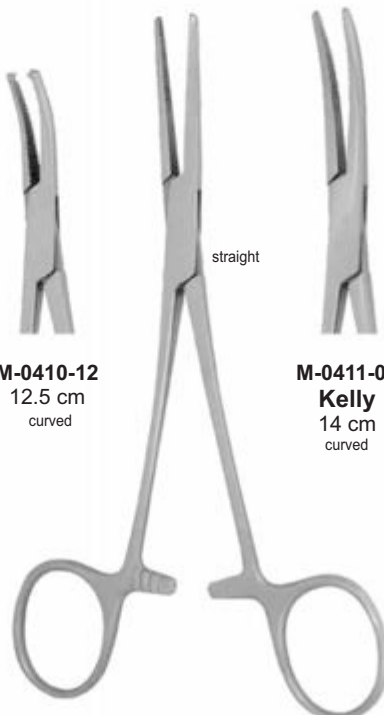

straight

**M-0411-02
Kelly
14 cm
curved**

**M-0411-01
Kelly
14 cm**



**M-0412-15
Allis
15 cm
Tissue Forceps**



M-0413-05
5.5 cm



M-0414-08
Jones
8 cm



M-0415-18
Schaedel
18 cm



M-0416-08
8 cm



M-0417-08
Backhaus
8.5 cm



M-0418-13
Backhaus
13 cm



M-0419-14
Edna (Lorna)
14 cm



M-0420-13 13 cm/5"
M-0420-15 15 cm/6"
Roeder



SEGITECH



www.segitech.net

Hohlmeißelzangen
Bone Rongeurs



M-0430-01
Blumenthal
15.5 cm

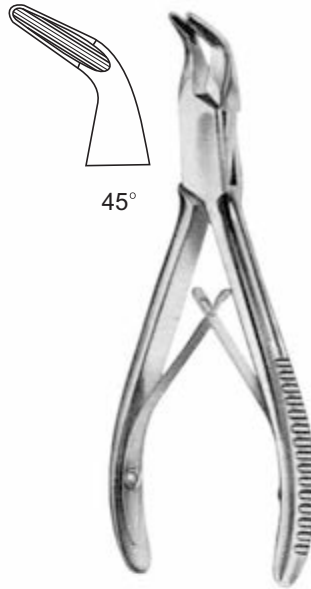

M-0430-02
Blumenthal
15.5 cm



M-0430-03
Blumenthal
15.5 cm

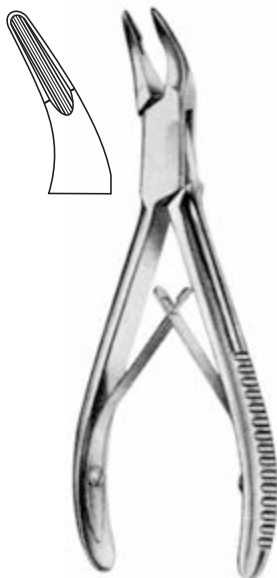

M-0430-04
Blumenthal S



M-0430-05
Blumenthal
18 cm

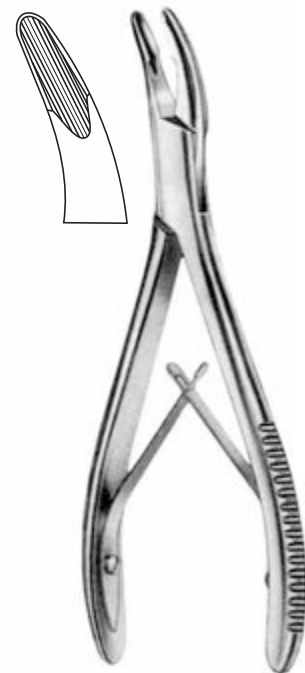

M-0431-01
Hartmann



**M-0437-03
Cleveland 3**

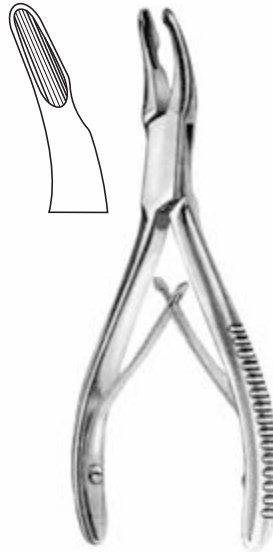

**M-0437-04
Cleveland 4
14 cm**



**M-0437-04A
Cleveland 4A
17 cm**



**M-0437-05
Cleveland
No. 5
17 cm**

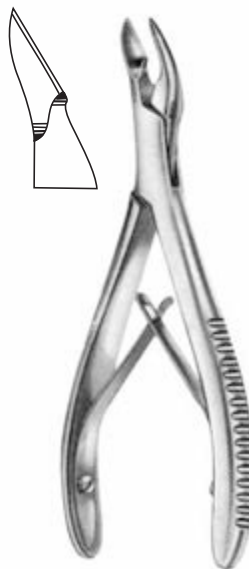

**M-0437-05S
Cleveland
No. 5S
15 cm**



**M-0437-10
Cleveland 10**

Hohlmeißelzangen
Bone Rongeurs



M-0432-01
Universal



M-0433-01
Mead 1A
16.5 cm



M-0433-02
Mead 2A



M-0434-14
Friedman
14 cm

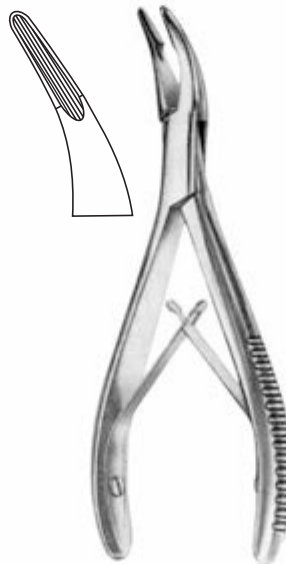

M-0435-15
Luer
15 cm

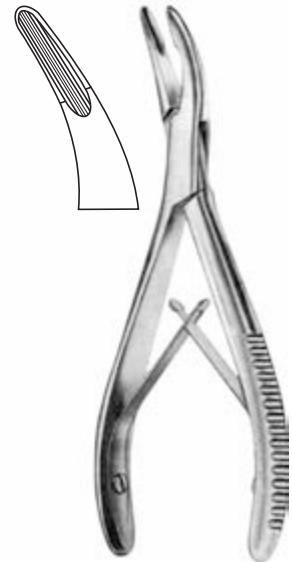

M-0436-15
Luer
15 cm

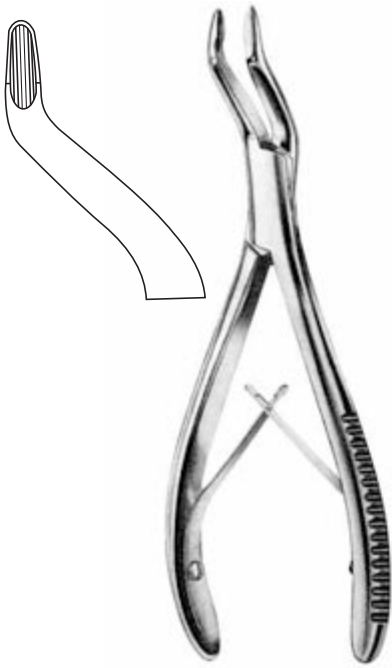

M-0438-01



M-0439-12
Friedmann-Grazil
12 cm

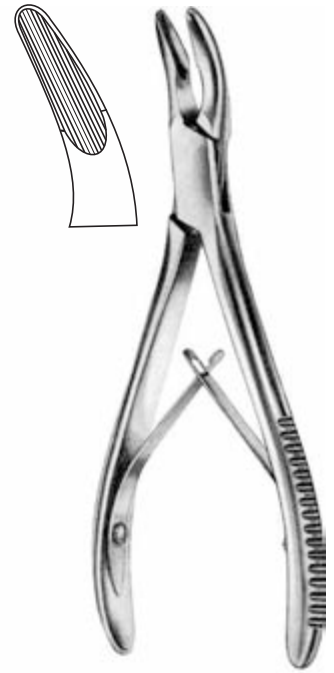

M-0440-01
Bane



M-0441-01
Jansen

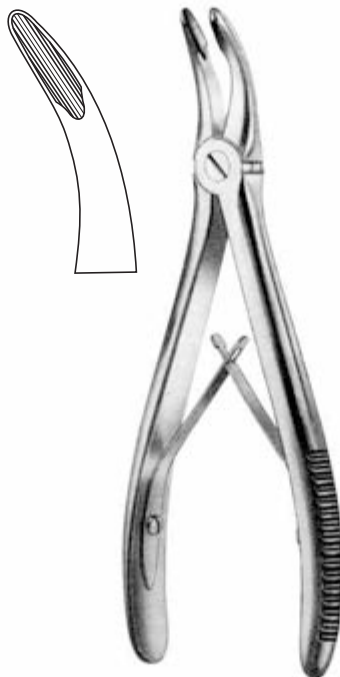

M-0441-02
Jansen

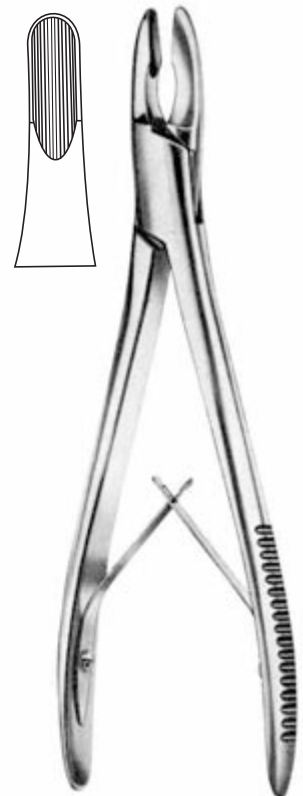

M-0442-01
Adson

Hohlmeißelzangen
Bone Rongeurs



M-0443-17
Luer
17 cm



M-0444-01
Cleveland-Gardner
16 cm

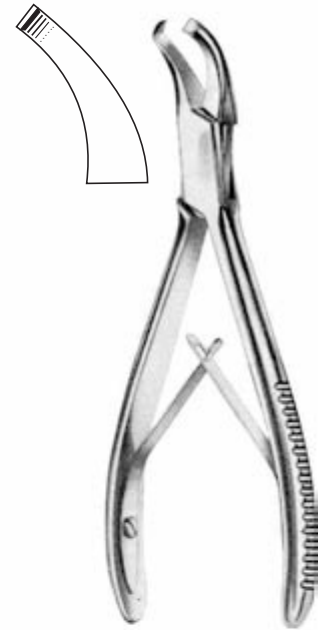

M-0444-02
Cleveland-Gardner
16 cm

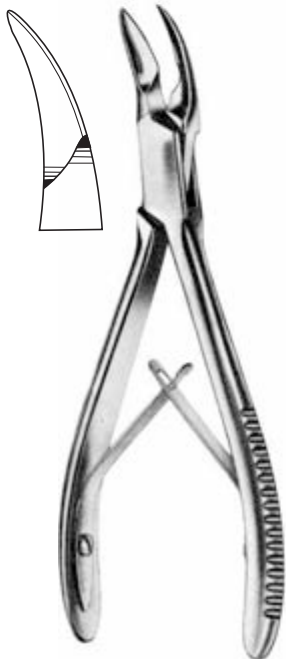

M-0445-01



M-0446-01

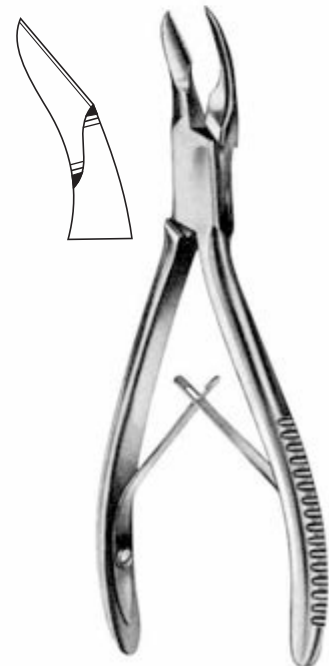

M-0447-01



M-0448-18
Ruskin
18 cm

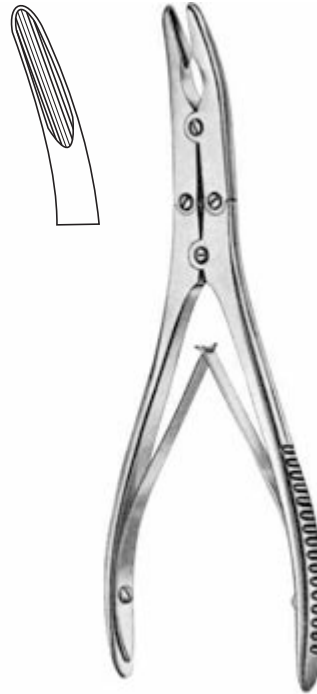

M-0449-18
Beyer
18 cm



M-0450-14
Liston
14 cm



M-0450-19
Liston
19 cm

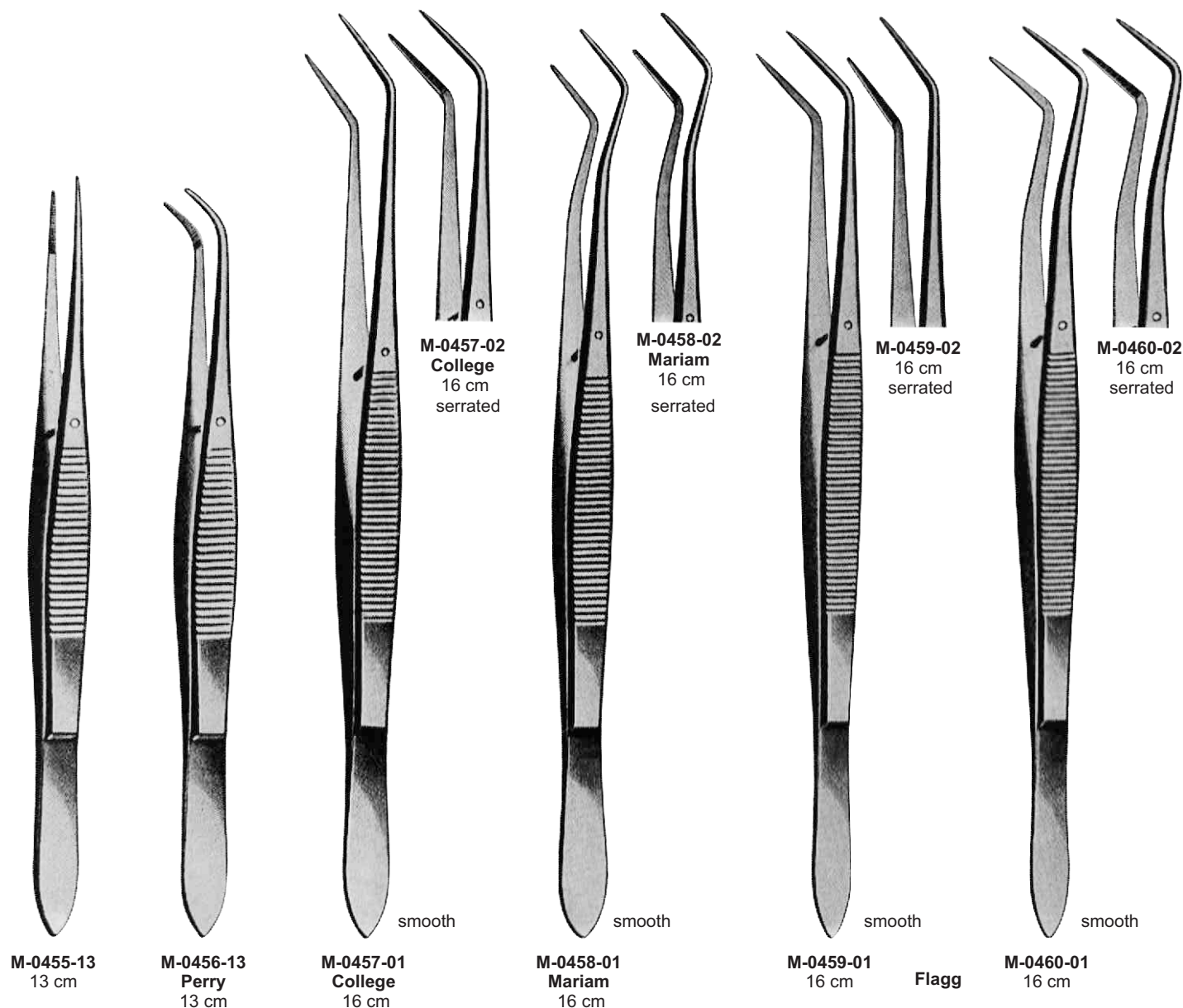

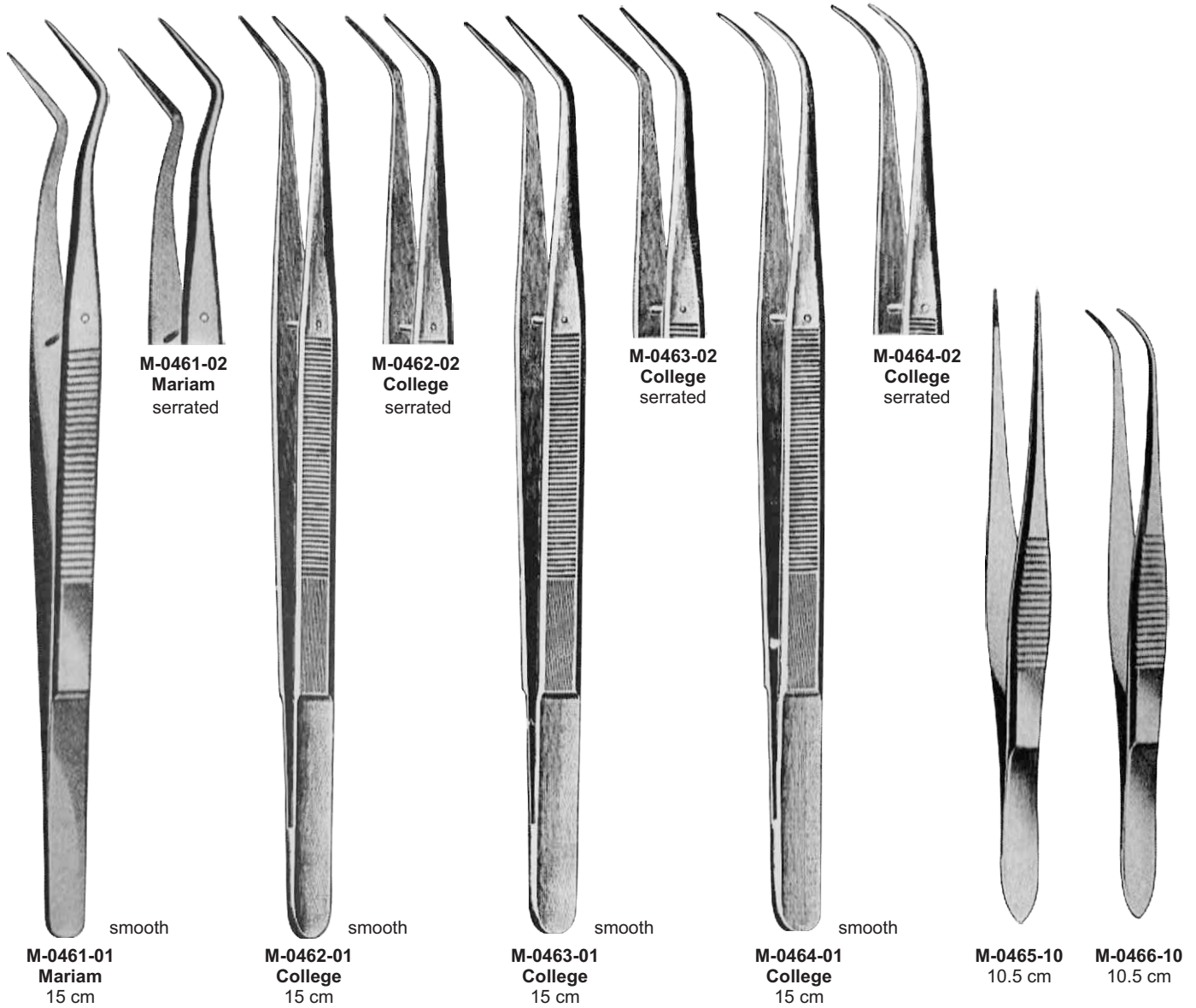

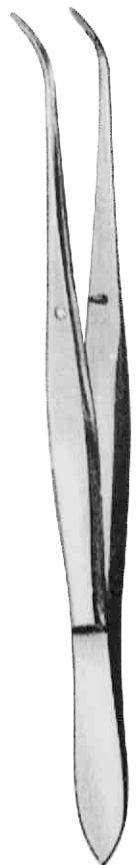

M-0467-01
Perry



M-0468-10



M-0469-18

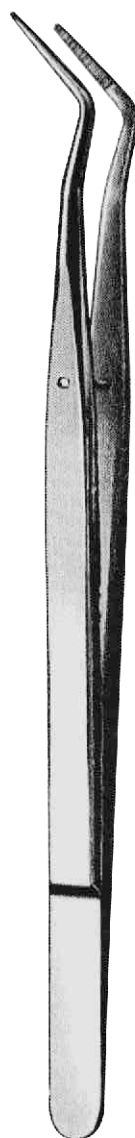

M-0470-17



M-0471-03



M-0472-02
College



M-0473-18L

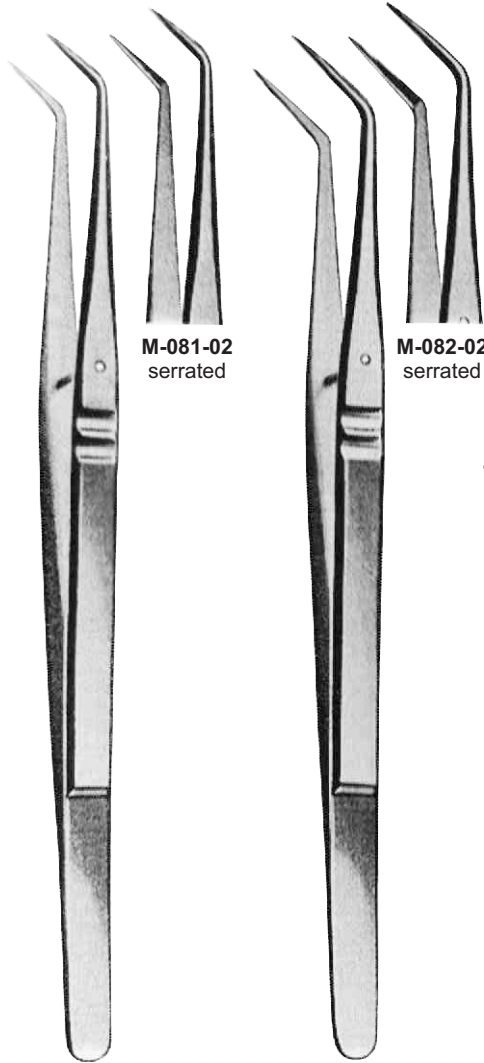

M-0481-01
15 cm

College

M-0482-01
15 cm

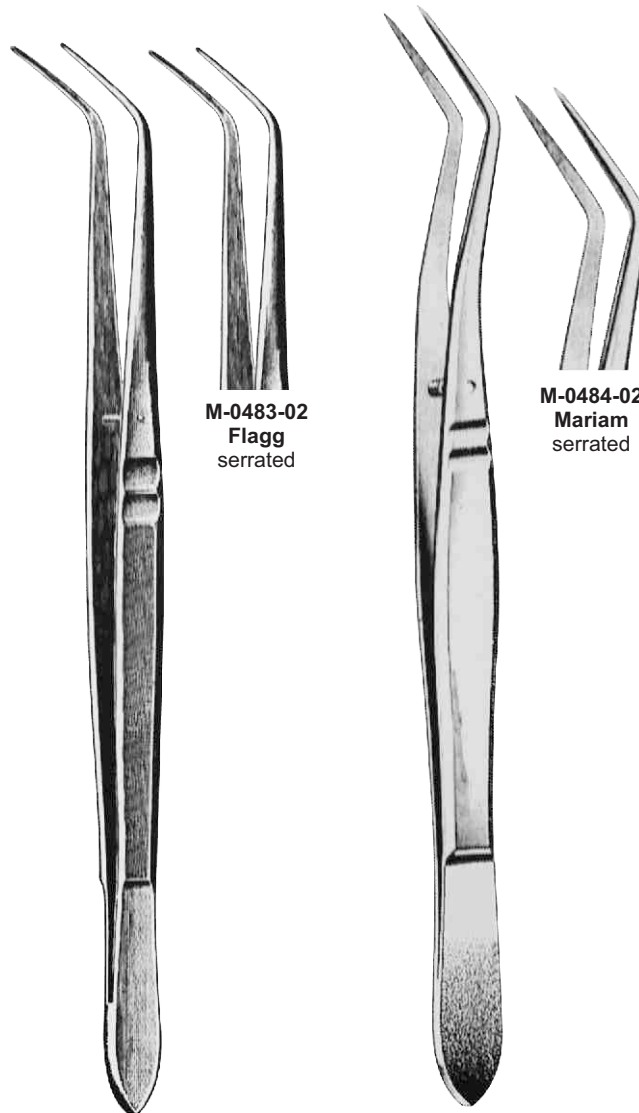

M-0483-01
Flagg
16 cm

M-0484-01
Mariam
16 cm

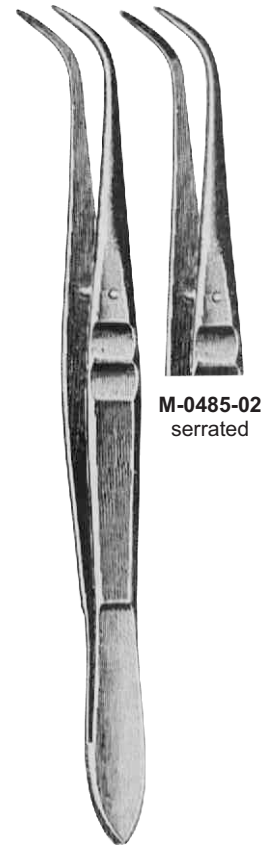

M-0485-01
13 cm

Zhan pinzette Dental Pliers

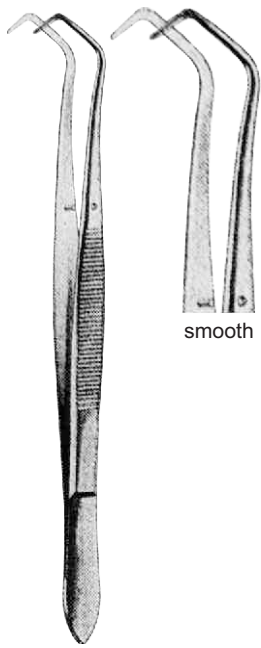

smooth

M-0474-15
15 cm

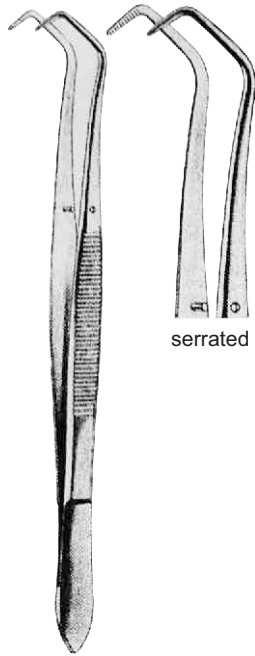

serrated

M-0475-15
15 cm

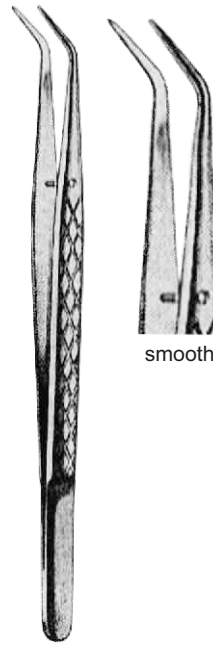

smooth

M-0476-15
15 cm

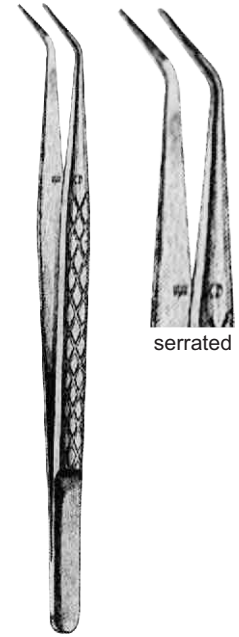

serrated

M-0477-15
15 cm

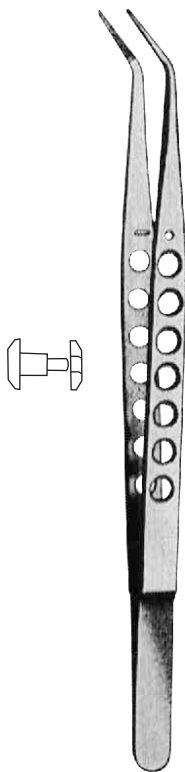

M-0478-15
15 cm

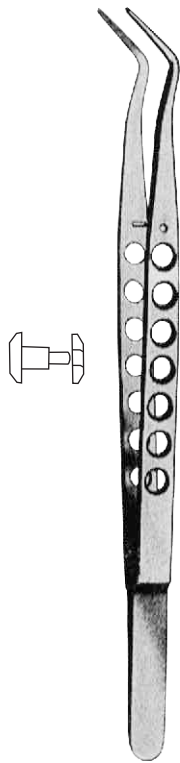

M-0479-15
15 cm

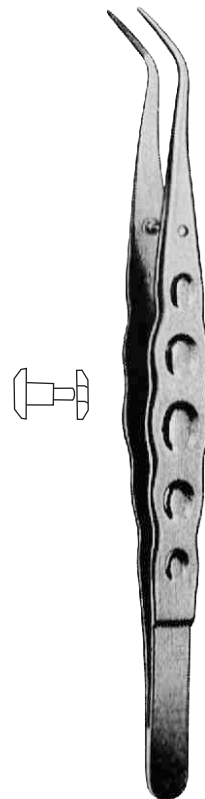

M-0480-15
15 cm



M-0486-00
15 cm

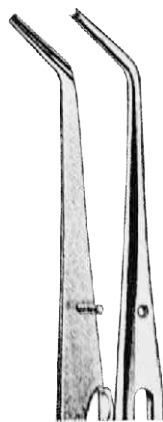

M-0486-01

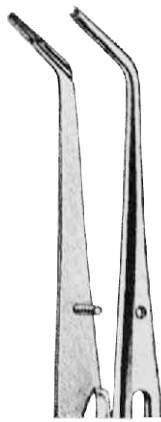

M-0486-02



M-0487-00
15 cm

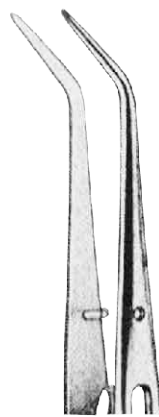

M-0487-01

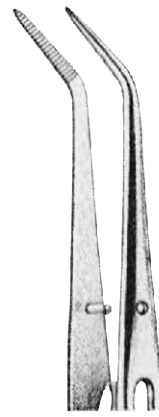

M-0487-02

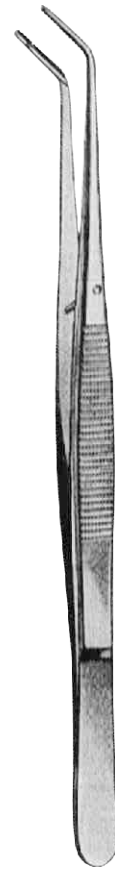

M-0488-15
15 cm



M-0489-15
Amsterdam
15.5 cm

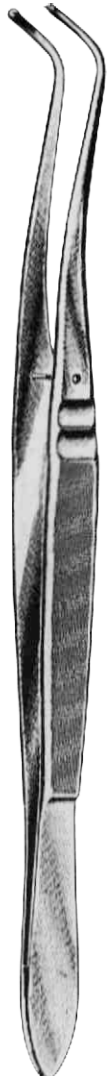

M-0490-15
Tiebbes
15.5 cm



M-0491-01



M-0491-02

Gillies
15 cm

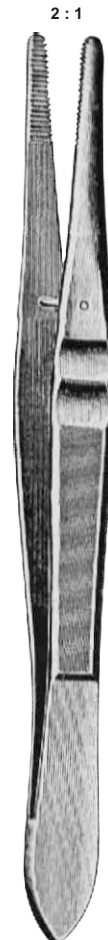

M-0492-13
13 cm



M-0493-13
13 cm

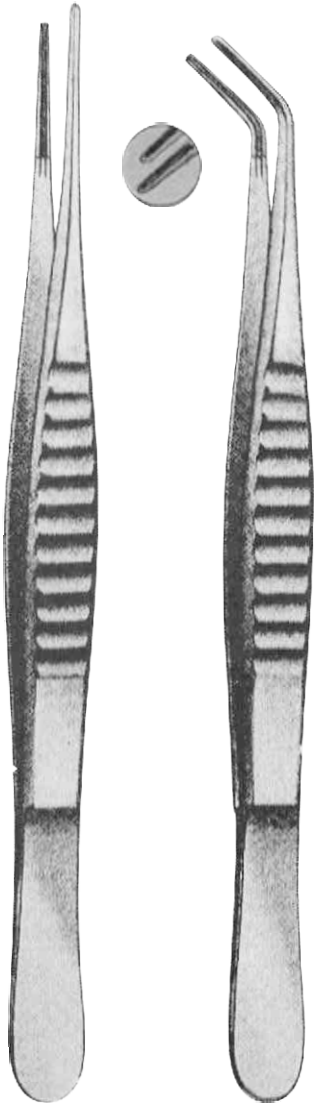

M-0494-01

M-0494-02

De Bakey
15 cm

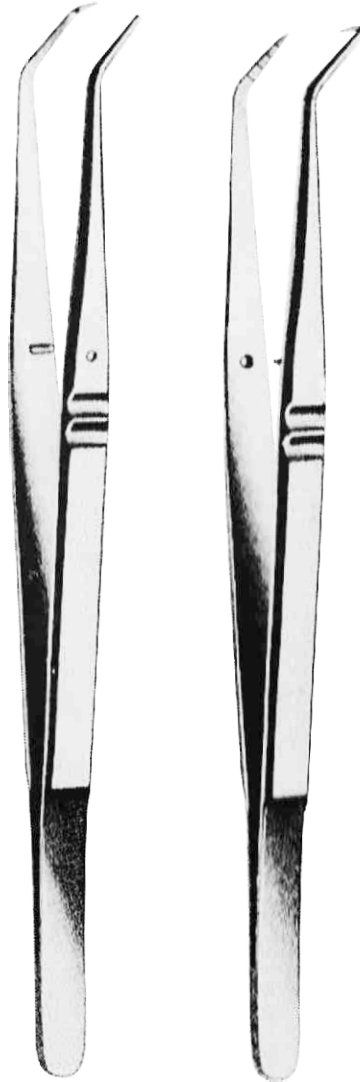

M-0495-01

M-0495-02

Crane-Kaplan
15 cm



M-0496-15
15 cm

Instruments Anatomische Pinzetten Dressing Forceps



M-0497-00
Standard

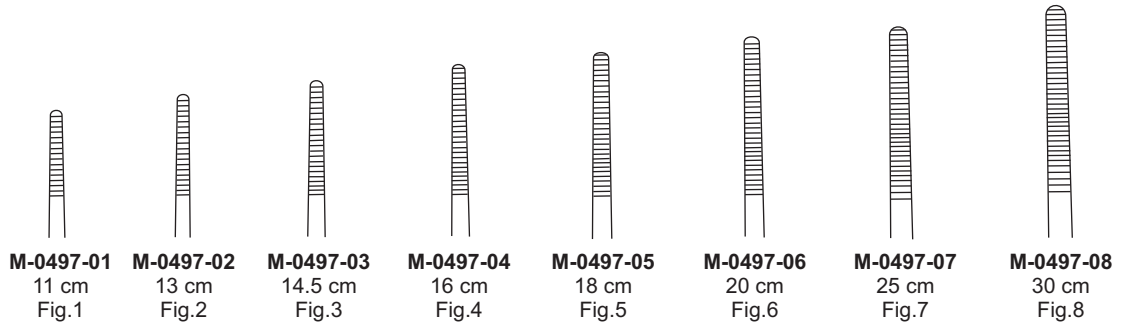

M-0498-00
Standard

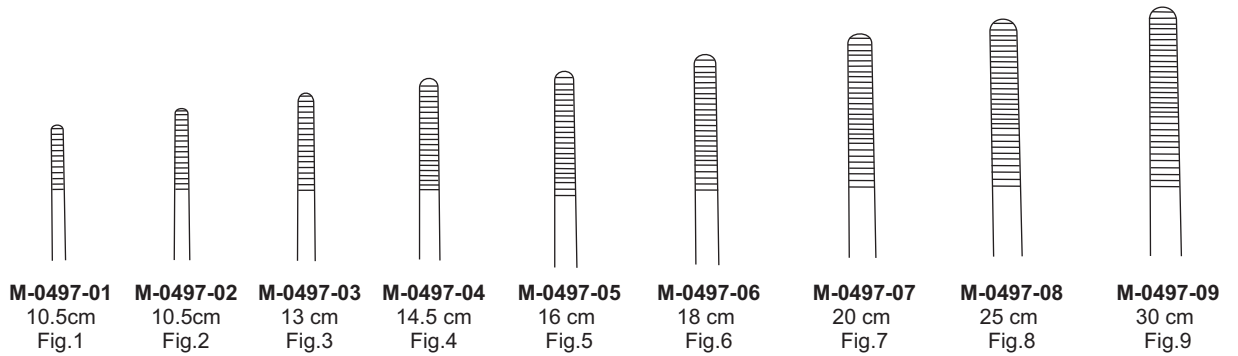



**M-0498-15
Adson**

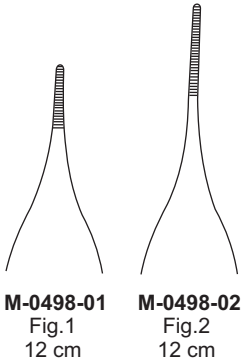

**M-0498-01
Fig.1
12 cm**

**M-0498-02
Fig.2
12 cm**



**M-0499-15
McIndoe
15 cm**



**M-0500-15
Gracile
15 cm**

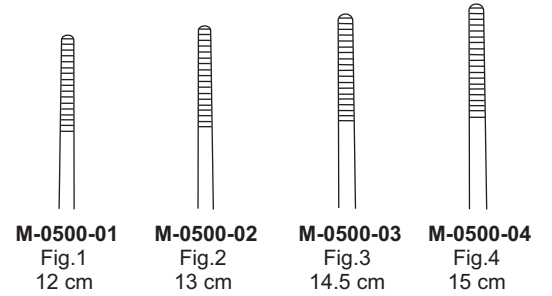

**M-0500-01
Fig.1
12 cm**

**M-0500-02
Fig.2
13 cm**

**M-0500-03
Fig.3
14.5 cm**

**M-0500-04
Fig.4
15 cm**



**M-0501-00
Standard**

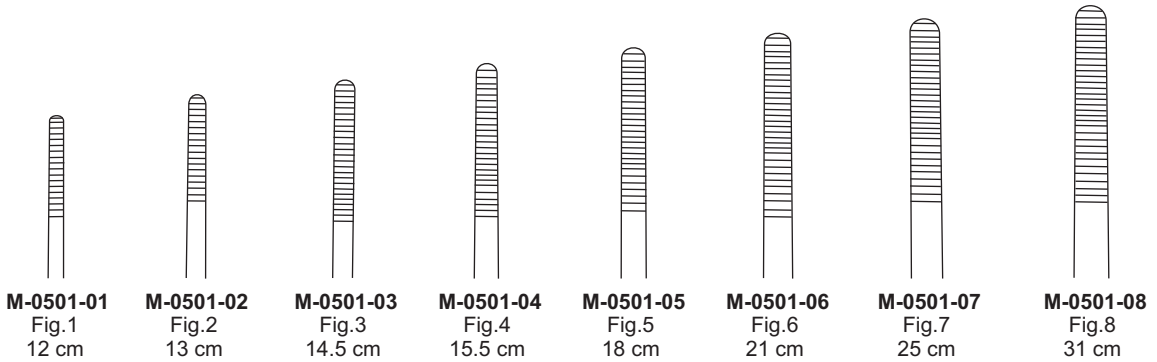

**M-0501-01
Fig.1
12 cm**

**M-0501-02
Fig.2
13 cm**

**M-0501-03
Fig.3
14.5 cm**

**M-0501-04
Fig.4
15.5 cm**

**M-0501-05
Fig.5
18 cm**

**M-0501-06
Fig.6
21 cm**

**M-0501-07
Fig.7
25 cm**

**M-0501-08
Fig.8
31 cm**

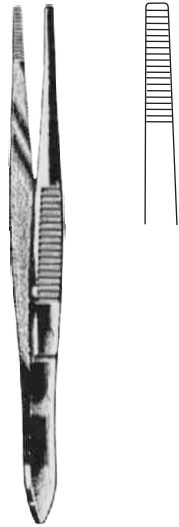

M-0502-15
Stille



M-0503-00
Mod Martin

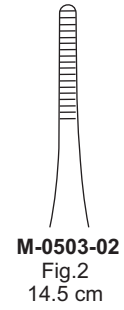
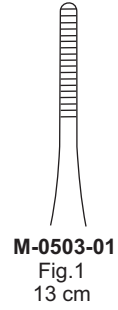

M-0504-00

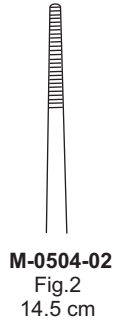
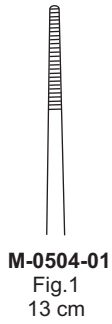

M-0505-00

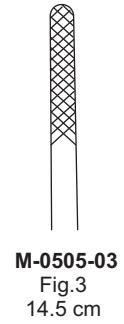
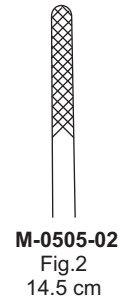



M-0506-00
Potts Smith



M-0506-01
Fig.1
18 cm



M-0506-02
Fig.2
21 cm



M-0506-03
Fig.3
25 cm



M-0507-01
Gerald
18 cm



M-0507-02
Gerald
18 cm



M-0508-17
17.5 cm



M-0508-01
17.5 cm



M-0508-02
17.5 cm

Instruments Anatomische Pinzetten
Dressing Forceps

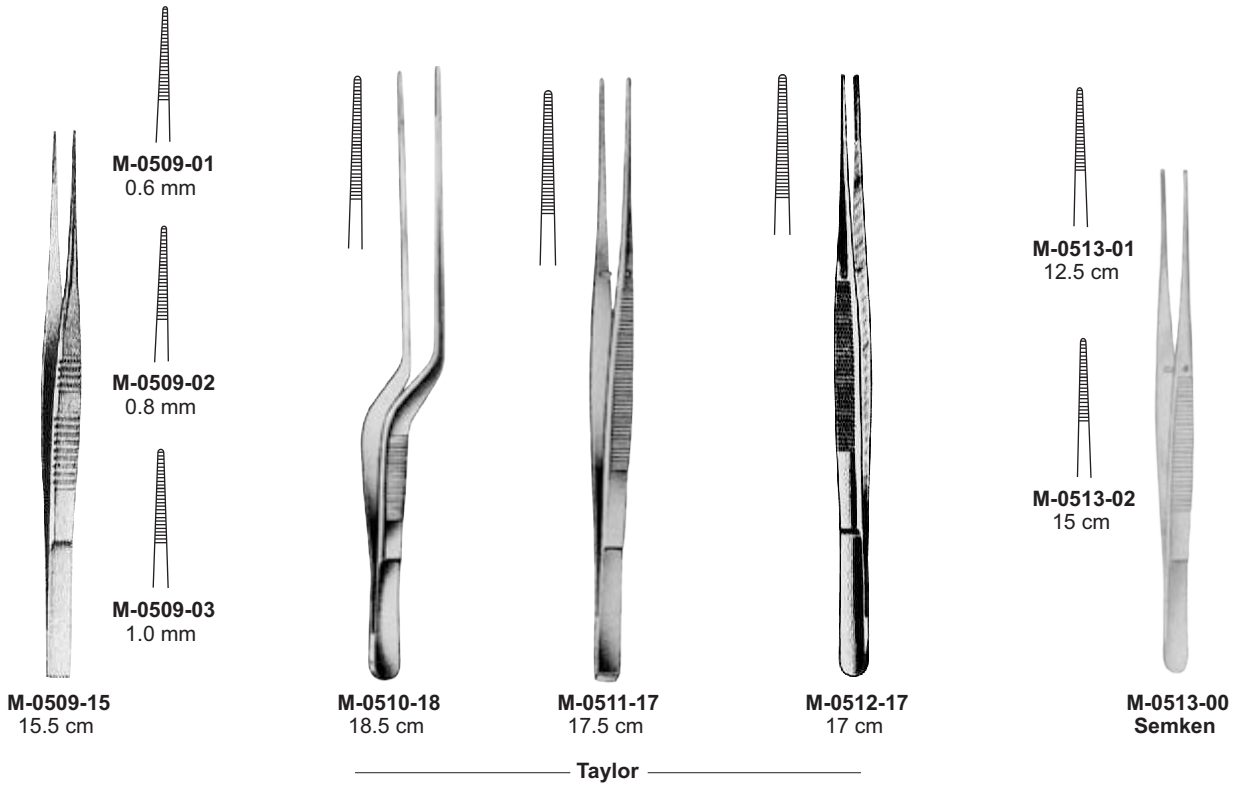



M-0514-00
1x2 Teeth

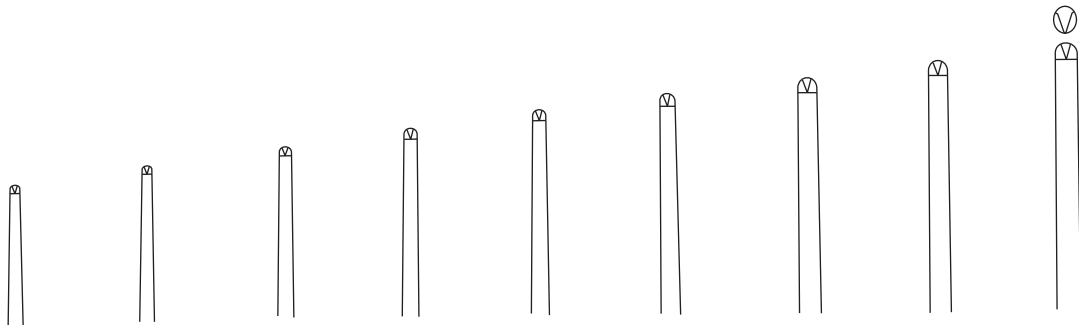

M-0514-01 Fig.1 10.5 cm	M-0514-02 Fig.2 11.5 cm	M-0514-03 Fig.3 13 cm	M-0514-04 Fig.4 14.5 cm	M-0514-05 Fig.5 16 cm	M-0514-06 Fig.6 16 cm	M-0514-07 Fig.7 20 cm	M-0514-08 Fig.8 25 cm	M-0514-09 Fig.9 30 cm
--------------------------------------	--------------------------------------	------------------------------------	--------------------------------------	------------------------------------	------------------------------------	------------------------------------	------------------------------------	------------------------------------



M-0515-00
2x3 Teeth

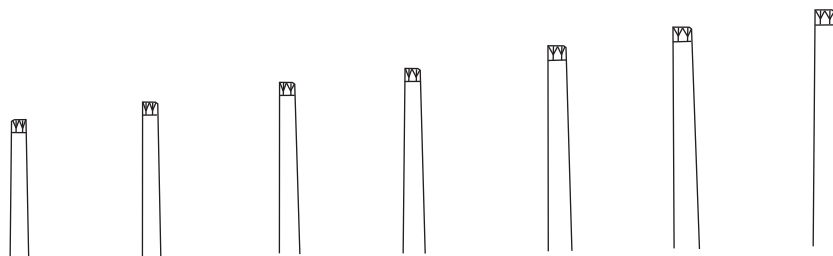

M-0516-01 Fig.1 11.5 cm	M-0516-02 Fig.2 13 cm	M-0516-03 Fig.3 14.5 cm	M-0516-04 Fig.4 16 cm	M-0516-05 Fig.5 18 cm	M-0516-06 Fig.6 20 cm	M-0516-07 Fig.7 25 cm
--------------------------------------	------------------------------------	--------------------------------------	------------------------------------	------------------------------------	------------------------------------	------------------------------------

Instruments Anatomische Pinzetten Dressing Forceps



M-0517-00
1x2 Teeth
13 cm

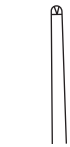

M-0517-01
Fig.1
13 cm



M-0517-02
Fig.2
14 cm



M-0518-00
1x2 Teeth
13 cm



M-0517-01
Fig.1
13 cm



M-0517-02
Fig.2
14 cm



M-0517-03
Fig.3
16 cm



M-0517-04
Fig.4
20 cm



M-0519-00
4x5 Teeth
13 cm



M-0519-01
Fig.1
13 cm



M-0519-02
Fig.2
14.5 cm



M-0519-03
Fig.3
16 cm



M-0520-00
3x4 Teeth
13 cm



M-0520-01
Fig.1
13 cm



M-0520-02
Fig.2
13 cm



M-0520-03
Fig.3
13 cm



M-0521-00
Mod USA
12 cm



M-0521-01
Fig.1
12 cm



M-0521-02
Fig.2
13 cm



M-0521-03
Fig.3



M-0521-04
Fig.4
15.5 cm



M-0521-05
Fig.5
18.5 cm



M-0521-06
Fig.6
21 cm



M-0521-07
Fig.7
25 cm



M-0521-08
Fig.8
31 cm



M-0522-01
Stille
1x2 Teeth
15 cm



M-0522-02
Stille
2x3 Teeth
15 cm



M-0523-00
Mod Martin
1x2 Teeth



M-0523-01
Fig.1
13 cm



M-0523-02
Fig.2
14.5 cm



Fox
M-0524-01 13 cm
M-0524-02 15 cm



Fox
M-0525-01 13 cm
M-0525-02 15 cm

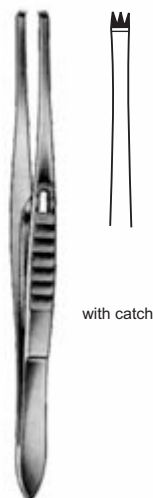

M-0526-13
Fox
13 cm

with catch

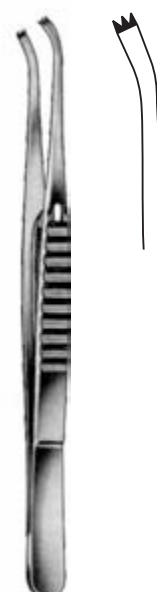

M-0527-13
Fox
13 cm

Splinter Forceps
Splitterpinzetten

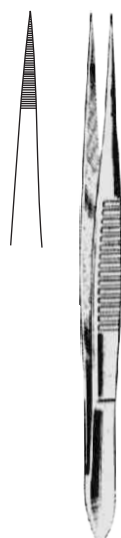

M-0528-08
8 cm

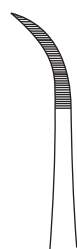

M-0529-08
8 cm



M-0530-08
Feilchenfeld
8 cm



M-0531-01



Hunter
10 cm

M-0531-02

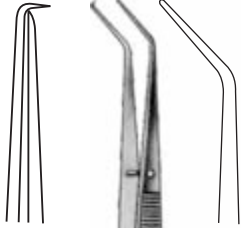

M-0532-01
CK 1
15 cm

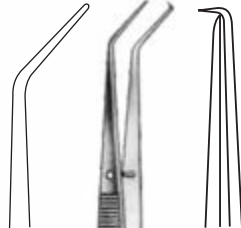

M-0532-02
CK 2
15 cm



M-0533-01
GF 1
16 cm

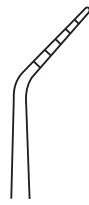

M-0533-02
GF 2
16 cm

**Transportpinzetten
Medicament Carrier Forceps**



M-0534-01
Kopp
15.5 cm



M-0534-02
Kopp
15.5 cm

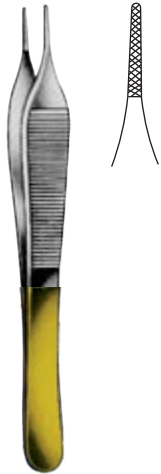

M-0535-12
Adson
12 cm



M-0536-01 12 cm
M-0536-02 15 cm
Semken



M-0537-15
College
15 cm



M-0538-15
Meriam
15 cm



M-0539-15
Potts-Smith
15 cm



M-0540-15
Standard
15 cm

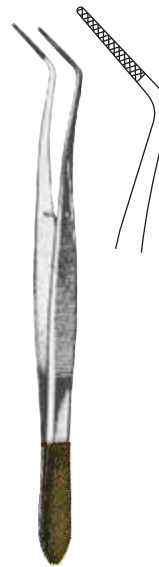

M-0541-15
Meriam
15 cm



M-0542-15
Cushing
15 cm



M-0543-01
16 cm



M-0543-02
16 cm



M-0543-03
16 cm

**Suture Forceps
Nahtpinzette**

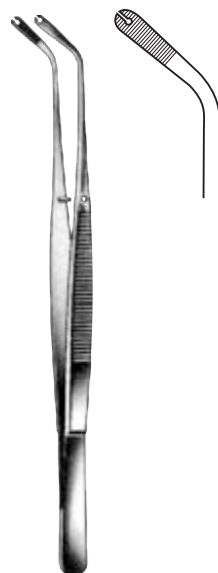

M-0544-15
15 cm

Pinzette zum zusammenhalten der Wundränder beim Nähen
Approximation Forceps for Suture

Flach- und Hohlmeißel Chisels and Gouges



M-0550-01
Gardner
17 cm



M-0550-01



M-0550-02



M-0550-03



M-0550-04



M-0550-05



Lucas
16 cm

M-0551-04 4 mm
M-0551-06 6 mm



4 mm

6 mm



Lucas
16 cm

M-0552-03 3 mm
M-0552-05 5 mm



3 mm

5 mm



Partsch
14 cm

M-0553-03 3 mm
M-0553-04 4 mm
M-0553-05 5 mm
M-0553-06 6 mm



3 mm

4 mm

5 mm

6 mm



Partsch
17 cm

M-0554-03 3 mm
M-0554-04 4 mm
M-0554-05 5 mm
M-0554-06 6 mm
M-0554-07 7 mm



3 mm

4 mm

5 mm

6 mm

7 mm



Partsch
14 cm

M-0555-03 3 mm
M-0555-04 4 mm
M-0555-05 5 mm
M-0555-06 6 mm



3 mm

4 mm

5 mm

6 mm



Partsch
17 cm

M-0556-03 3 mm
M-0556-04 4 mm
M-0556-05 5 mm
M-0556-06 6 mm



3 mm

4 mm

5 mm

6 mm

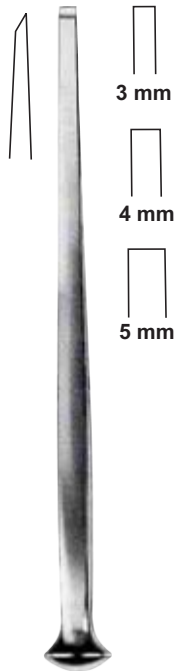

Alexander
17 ½ cm

- M-0557-03 3 mm
- M-0557-04 4 mm
- M-0557-05 5 mm



Alexander
17 ½ cm

- M-0558-03 3 mm
- M-0558-04 4 mm
- M-0558-05 5 mm

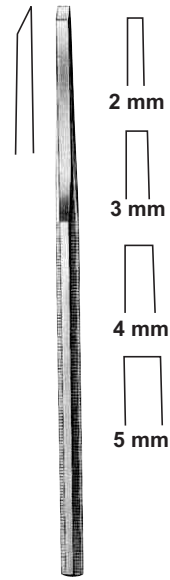

Bishop
15 cm

- M-0559-02 2 mm
- M-0559-03 3 mm
- M-0559-04 4 mm
- M-0559-05 5 mm

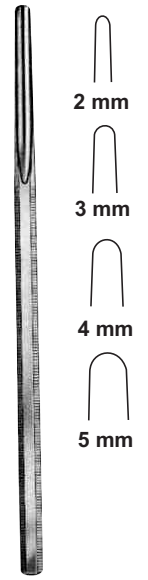

Bishop
15 cm

- M-0560-02 2 mm
- M-0560-03 3 mm
- M-0560-04 4 mm
- M-0560-05 5 mm



M-0561-01
Miller

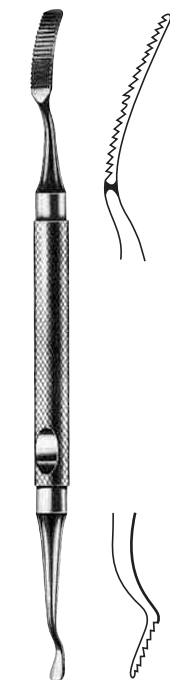

M-0561-02
Miller

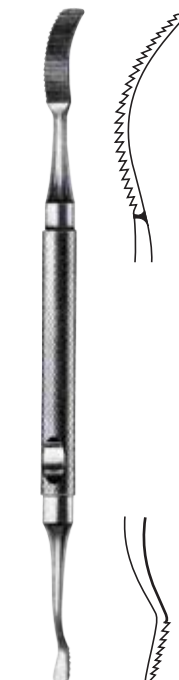

M-0561-03
Miller



M-0562-01
Seldin

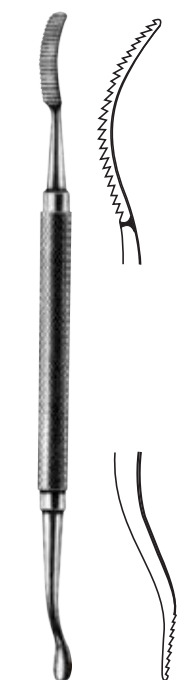

M-0562-02
Seldin

Knochenkuretten Bone Currettes



M-0563-00
HOLLOW
LIGHT

M-0564-01
Hemingway
Fig. 1

M-0564-02
Hemingway
Fig. 2

M-0564-03
Hemingway
Fig. 3

M-0564-04
Hemingway
Fig. 4

M-0565-01
Lucas
Fig. 1

M-0565-02
Lucas
Fig. 2

M-0565-03
Lucas
Fig. 3

M-0565-04
Lucas
Fig. 4

15 x 15 mm



**M-0566-01
Middledorpf**

20 x 22 mm



M-0566-02

28 x 28 mm



M-0566-03

15 x 15 mm



**M-0567-01
Middledorpf**

20 x 22 mm



M-0567-02

28 x 28 mm



M-0567-03

30 x 10 mm



**M-0568-01
Langenbeck**

40 x 10 mm



M-0568-02



40 x 13 mm

M-0568-03



50 x 10 mm

M-0568-04



50 x 13 mm

M-0568-05

33 x 20 mm



**M-0569-00
Wassmund**

56 x 11 mm



**M-0570-01
Kocher**

40 x 11 mm



**M-0570-02
Kocher**

Sharp



M-0571-01

Blunt



M-0571-02



**M-0572-01
Senn-Mueller**

Wundhaken Retractors



M-0573-01



M-0574-01



M-0575-01



Straight - Blunt



M-0573-02



Left - Blunt



M-0574-02



Right - Blunt



M-0575-02



M-0573-03



Williger



M-0574-03

Williger



Williger



M-0575-03



M-0576-01



M-0577-01



M-0578-01



Straight
Sharp



M-0576-02



Left - Sharp



M-0577-02



Right - Sharp



M-0578-02



M-0576-03



Williger



M-0577-03

Williger



Williger



M-0578-03



Oringer

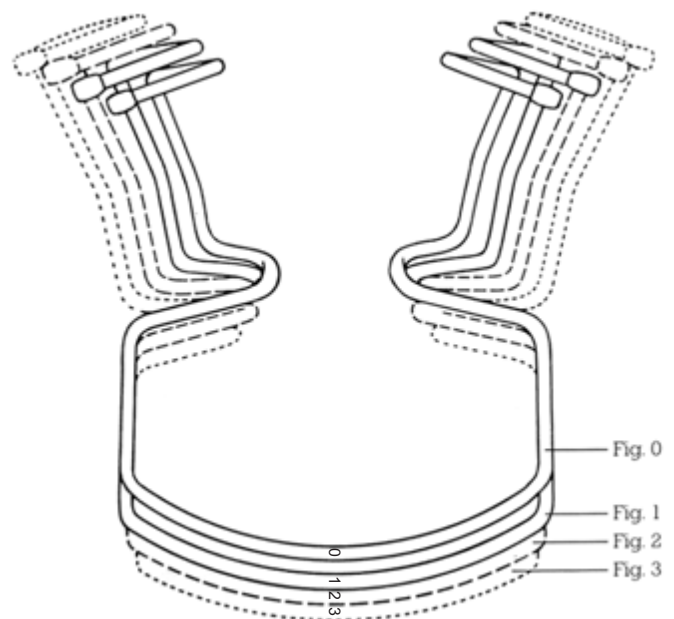

- | | | |
|---------------|-----------------|----------------------------|
| M-0579-00 | Fig. 0 | für kinder
for children |
| M-0579-01 | Fig. 1 | |
| M-0579-02 | Fig. 2 | |
| M-0579-03 | Fig. 3 | |
| M-0579-1 to 3 | Set Fig. 1 to 3 | |

Lippen - und Wangenhalter
Lip and Cheek Retractor



M-0580-15
Cawood-Minnesota
 15.5 cm



26 x 10 mm
 23 x 10 mm

28 x 12 mm
 30 x 12 mm

M-0581-13
Farabeuf
 13 cm



Sternberg

- M-0582-01 14 cm
- M-0582-02 16 cm
- M-0582-03 18 cm



Sternberg

- M-0583-01 12 cm
- M-0583-02 14 cm
- M-0583-03 16 cm

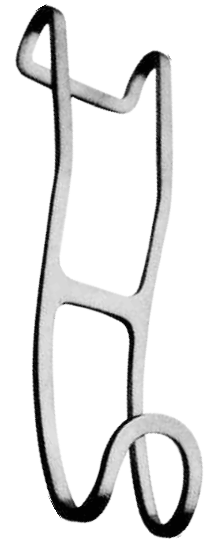

M-0584-15
 15 cm



M-0585-14
 14 cm



M-0586-23
Divaricatore Labiale
 23.5 cm



M-0587-00



M-0588-17
 17 cm



M-0589-14
University of Minnesota
14 cm



M-0590-13
Farabeuf
13 cm



M-0591-08
Bosworth
working length 8 cm

M-0592-14
Tobold
working length 8 cm
14.5 cm

M-0593-14
Wieder
working length 8 cm
14.5 cm

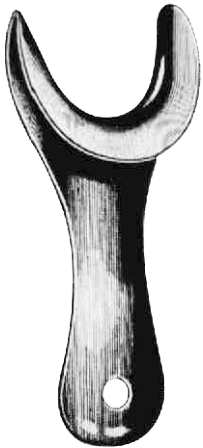

M-0594-11
Simplex
11 cm



M-0595-18
18 cm



M-0595-01
Kirkland



M-0595-02



M-0596-01
Brunings
19 cm



M-0596-02



M-0597-01



M-0597-02

Luniatschek

Zungendrucker und Zungenzangen
Tongue Depressors and Tongue Holding forceps

complete set



M-0598-01



M-0598-01A



M-0598-01B



M-0598-01C



M-0599-00
Watterollenhalter
 Cotton wool roll holder



M-0600-19
Guy
 19 cm



M-0601-17
Collin
 17 cm



M-0602-17
Young
 17 cm



M-0605-12
Denhard
12 cm



M-0606-01
Roser Koenig
16 cm



M-0606-02
Roser Koenig
19 cm

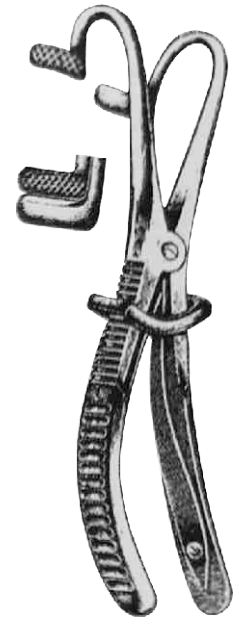

M-0607-15
Fergusson-Ackland
15.5 cm



M-0608-12
Doyen-Collin
12 cm



M-0609-14
Doyen-Jansen
14 cm



M-0610-01
Molt
11 cm



M-0610-02
Molt
14 cm

**Mundsperrer
Mouth Gags**



Jennings

- M-0611-01 11 cm
- M-0611-02 13 cm
- M-0611-03 15 cm

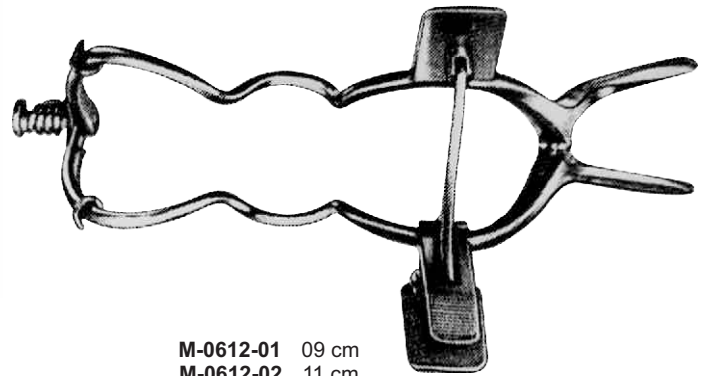

- M-0612-01 09 cm
- M-0612-02 11 cm
- M-0612-03 13 cm
- M-0612-04 15 cm
- Seemann-Seiffert
(Self-retaining)



- M-0613-01 11 cm
- M-0613-02 13 cm
- M-0613-03 15 cm

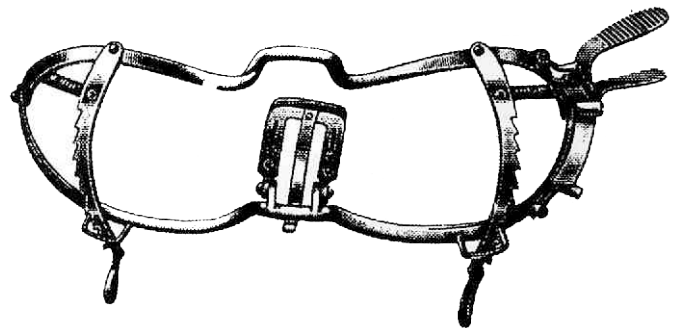

M-0614-13 13 cm

Whitehead

Finger Protectors



M-0615-01
Heister
with two screws



M-0615-02
Heister
with two screws



M-0616-00
Heister
Detachable



M-0617-01
Fig. 1
Langenbeak
17 / 21 mm



M-0617-02
Fig. 2
Langenbeak
19 / 24 mm



M-0617-03
Fig. 3
Langenbeak
21 / 26 mm



M-0618-00
Davis-Boyle

M-0618-01
27 x 105 mm



M-0618-02
25 x 90mm



M-0618-03
25 x 75 mm



M-0618-04
22 x 60mm



M-0618-05
20 x 25 mm

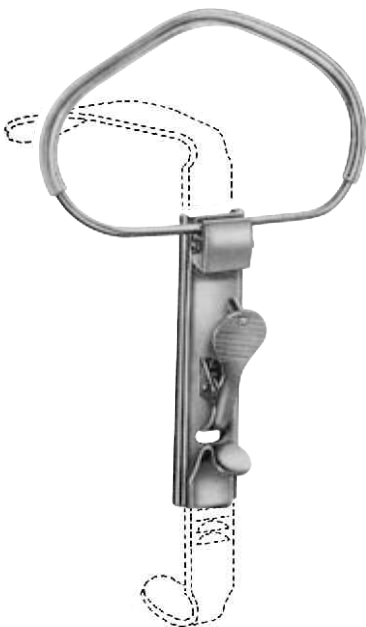

M-0619-00
McIvor



M-0619-01
27x95mm



M-0619-02
22x85mm



M-0619-03
22x70mm

**Kofferdam-Klammerzangen
Rubber Dam Clamp Forceps**



**M-0620-17
Stockes
17 cm**



**M-0621-17
Palmer
17 cm**

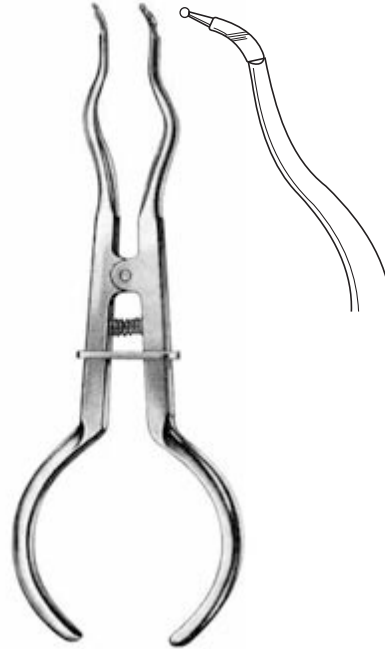

**M-0622-17
Brewer
17 cm**

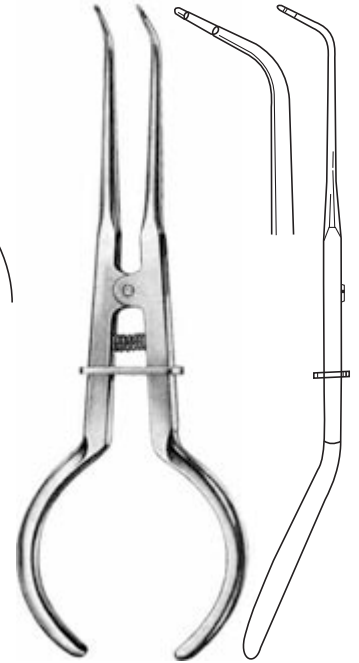

**M-0623-17
White
17 cm**



**M-0624-17
17 cm**



**M-0625-01
Ivory
17 cm**



**M-0625-02
Ivory
17 cm**



M-0626-01



M-0627-02
Ainsworth
17 cm



M-0627-03
Ainsworth



M-0627-04
Ainsworth



M-0628-01
Ivory
16 cm



M-0628-02
Ivory
16 cm



M-0628A-00

M-0629-01
Rubber Dam Frame
for Adult

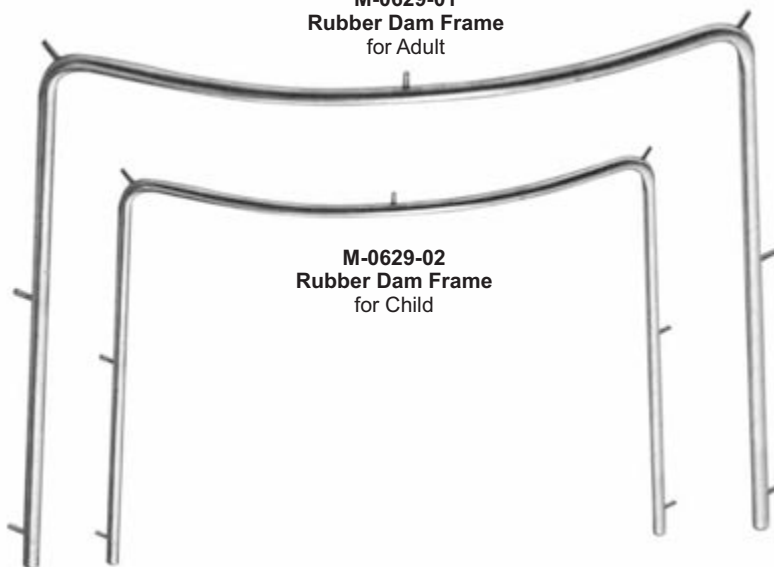

M-0629-02
Rubber Dam Frame
for Child



**M-0630-01
Fig. W8A**
For molar roots
and partially-erupted
or irregularly- shaped
small molars.



**M-0630-02
Fig. W14**
For Partially-Erupted
or irregularly-shaped molars



**M-0630-03
Fig. W14A**
Large molar clamp.
Partially-Erupted
or irregularly-shaped
large molars.



**M-0630-04
Fig. 14A**
Large molar clamp.
For large Partially-Erupted
or irregularly-shaped
molars.



**M-0630-05
Fig. 14**
For Partially-Erupted
or irregularly-shaped
molars.



**M-0630-06
Fig. 12A**



**M-0630-07
Fig. 13A**

Right and left molars.

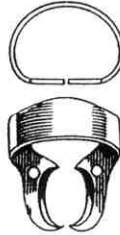

**M-0630-08
Fig. 15**
Lower Molars.
large molar clamp.
Large bow and jaws.



**M-0630-09
Fig. 8**
Upper Molars.

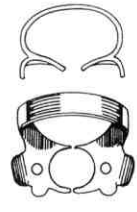

**M-0630-10
Fig. A**
For Molar Roots and
partially-erupted or
irregularly-shaped
smaller molars. Jaws have
a four-point contact
at the corners.



**M-0630-11
Fig. 18**
Delos Palmer Molar Clamp.
Stiff bow.



**M-0630-12
Fig. 24**



**M-0630-13
Fig. 25**

Right and left molars.
For subgingival cavities on
the buccal or lingual surfaces.



**M-0630-14
Fig. 3**
Lower Molars.
Small molar clamp
Flat jaws avoid gum impingement



**M-0630-15
Fig. 3**
Upper Molars.



**M-0630-16
Fig. 5**
Upper Molars.
Large molar clamp.

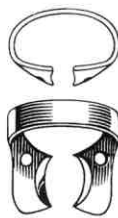

**M-0630-17
Fig. 26**
Molar clamps left
and right wingless.



**M-0630-18
Fig. 28**
Molar clamps left
and right wingless.



**M-0630-19
Fig. 30**
Molar clamps left
and right wingless.



**M-0630-20
Fig. 31**
Molar clamps left
and right wingless.

Kofferdam-Klammern Rubber Dam Clamps



M-0630-21
Fig. 51
Molar clamps left
and right wingless.



M-0630-22
Fig. 138
Left and right molars.
For third molars.

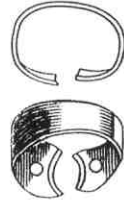

M-0630-23
Fig. 139
Especially well-suited.



M-0630-24
Fig. 202
Lower molars.
Large molar clamp.



M-0630-25
Fig. 205
Upper molars.
Large molar clamp.



M-0630-26
Fig. 200
Lower molars winged.



M-0630-27
Fig. 201
Lower molars winged.



M-0630-28
Fig. 203
Small molars left
and right winged.



M-0630-29
Fig. 204
Small molars left
and right winged.



M-0630-30
Fig. 00
Narrow jaws for
small bicuspsids.
High bow for extra
clearance.



M-0630-31
Fig. 22

For upper and lower bicuspsids-wingless.



M-0630-32
Fig. 27



M-0630-33
Fig. 29

Primarily for lower
bicuspsids. Broad
flange jaws provide increased
clearance between dam surface
and tooth crown.



M-0630-34
Fig. 206

For upper and lower
bicuspsids.



M-0630-35
Fig. 207

For upper and lower
bicuspsids.



M-0630-36
Fig. 208

With large jaws
that adapt to large
bicuspsids.

Labial Clamps.



M-0630-37
Fig. 209
Primarily for lower
bicuspsids. Small
flat jaws for small
bicuspsids.

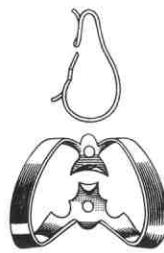

M-0630-38
Fig. 210
For labial cavities
on centrals and bicuspsids.

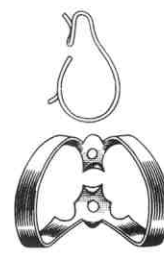

M-0630-39
Fig. 211
Universal clamp for labial
cavities on anterior teeth
and bicuspsids.



M-0630-40
Fig. 212
For labial cavities
on anterior teeth

Cervical Clamps.



M-0630-00
Fig. 00



M-0630-00
Fig. 0



M-0630-01
Fig. 1



M-0630-W2
Fig. W2



M-0630-1W3
Fig. W3



M-0630-W13
Fig. W13



M-0630-2A
Fig. 2A



M-0630-09
Fig. 9



M-0630-26
Fig. 26N



M-0630-02
Fig. 2



M-0630-07
Fig. 7



M-0630-7A
Fig. 7A



M-0630-12
Fig. 12



M-0630-17N
Fig. 17N



M-0630-56
Fig. 56



M-0630-60
Fig. 60

Matrizenspanner und Matrizenbänder Matrix Retainers and Matrix Bands



Matrizenspanner inklusive Matrizenband
Matrix retainer and matrix bands



M-0631-00
1 m
5 mm

M-0631-01
Ivory
Fig. 8
5 mm



M-0631-02
1 m
6 mm

M-0631-03
Ivory
Fig. 8
6 mm



M-0631-04
1 m
7 mm

M-0631-05
Ivory
Fig. 8
7 mm



rechts
right

M-0632-01
Nystrom
Fig. I



links
left

M-0632-02
Nystrom
Fig. II

Matrizenband zu Nystrom Matrizenspanner (1 m lang, 6 mm breit)
Matrix band for Nystrom matrix retainer (length 1 m, width 6 mm)

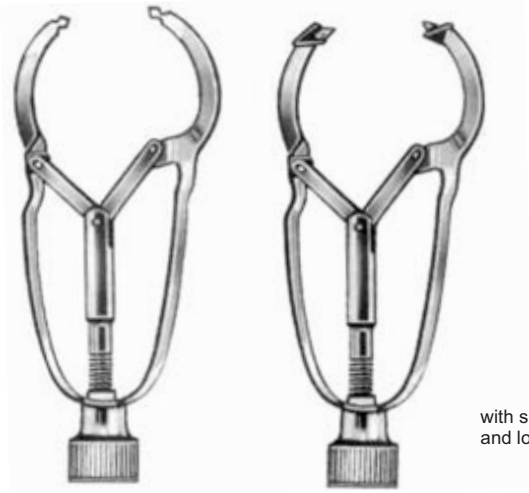

M-0632-03
1 m
6 mm

**Separatoren
Separators**

M-0633-01
Ivory
Fig. 1

M-0633-02
Ivory
Fig. 12

 with shields
and lock

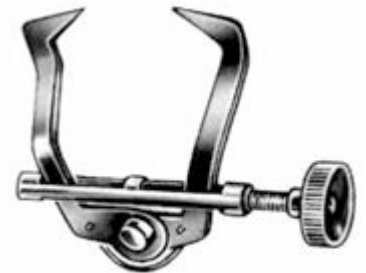
M-0633-03
Ivory
Fig. 12A

M-0634-01
Ivory

M-0635-01
Elliot

 für Molaren
for molars
para molares

M-0636-01
Fig. 1

 für Pramolaren
for premolars
para premolares

M-0636-04
Fig. 4

M-0636-02
Fig. 2

 Verpackungseinheit der Matrizenbänder: 1 Dutzend
Matrix bands supplied in packing unit of one dozen
Bandas disponibles en paquetes de 1 docena
Matrices livrees en paquets de 12 pieces
Matrici fornibili solo in pacchetti da 12 pezzi

M-0636-05
Fig. 5

M-0636-03
Fig. 3

M-0636-06
Fig. 6

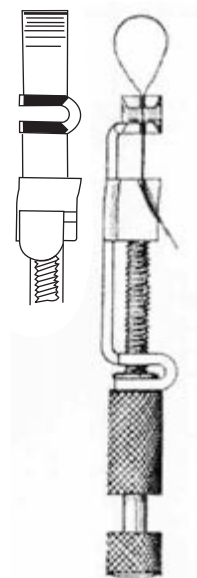
M-0637-01
Tofflemire

M-0637-02
Universal
Tofflemire

Zahnfleischmesser
Operating Knives



M-0638-02 M-0638-03 M-0638-04 M-0638-05 M-0638-06 M-0638-07 M-0638-08 M-0638-09 M-0638-10
Dieffenbach



M-0638-01



M-0639-15
Parker

M-0639-16
Parker



M-0640-11
Parker



M-0640-12
Parker



M-0640-13
Parker



M-0640-14
Parker



M-0641-3L
No. 3L
Solid Straight



M-0642-03
Standard
No. 3 Solid



M-0643-04
Standard
No. 4 Solid



M-0644-03
No. 3G
Solid



M-0645-08
No. 8
Hollow



M-0646-07
No. 7
Solid



M-0647-01
No. 3
Solid Straight



M-0647-02
No. 3
Solid Angled

Mundspiegelgriffe
Mirror Handles



M-0650-00
Hollow
Chrome Platted
and Stainless Steel

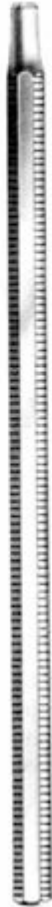

M-0651-00
Solid Stainless



M-0652-00
Hollow Stainless



M-0653-00
Hollow Stainless



M-0654-00
Solid Stainless



M-0655-00
Solid Stainless



M-0656-00
Solid Stainless



M-0657-00
Hollow Stainless



M-0658-00
Hollow Stainless



M-0659-00
Solid Stainless



M-0660-00
Solid Stainless



M-0661-00
Hollow Stainless

Mundspiegelgriffe
Mirror Handles



M-0662-01



M-0662-02



M-0662-03



M-0662-04



M-0662-05



M-0663-01



M-0663-02



M-0663-03



M-0663-04



**M-0664-02
Hilger**
Holder only
4.5 cm

**M-0664-01
Hilger**
Holder with welded-on handle
18 cm



∅mm	size	Plane, simple thread	Magnifying, simple thread
20	3	M-0665-03	M-0666-03
22	4	M-0665-04	M-0666-04
24	5	M-0665-05	M-0666-05
26	6	M-0665-06	M-0666-06

3
20 mm ∅

4
22 mm ∅

5
24 mm ∅

6
26 mm ∅



∅mm	size	Plane, Cone-Socket	Magnifying, Cone-Socket
20	3	M-0667-03	M-0668-03
22	4	M-0667-04	M-0668-04
24	5	M-0667-05	M-0668-05
26	6	M-0667-06	M-0668-06



M-0670-00



M-0670-01



M-0670-01



M-0670-01

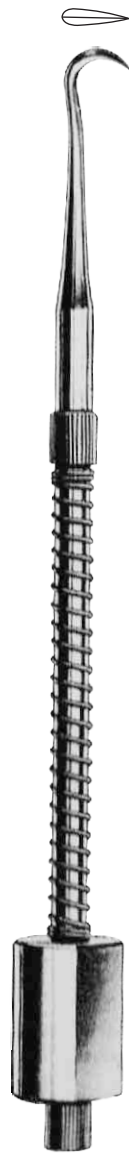

M-0671-00



M-0672-00



M-0672-09



M-0672-08



M-0672-07



M-0672-06



M-0672-05



M-0672-04



M-0672-03



M-0672-02



M-0672-01



M-0672-10



M-0673-05
Morrel Crown Remover
(Manual) Double ended
with 5 attachments
stainless steel



M-0674-03
Morrel Crown Remover
(Manual) Double ended
with 3 attachments
stainless steel

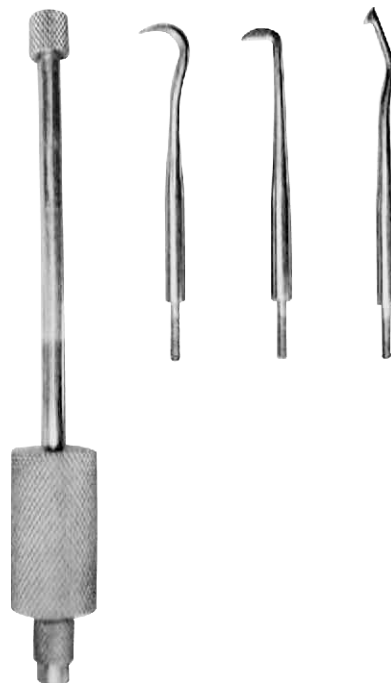

M-0675-03
Morrel Crown Remover
(Manual) Double ended
with 3 attachments
stainless steel

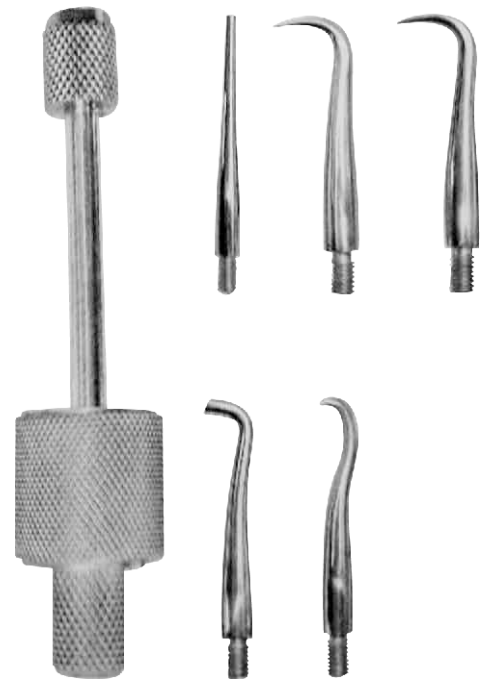

M-0676-05
Morrel Crown Remover
(Manual) Double ended
with 5 attachments
stainless steel



M-0677-02
Crown Remover
Complete with 2 points



M-0678-02
Crown and
bridges remover
with 2 points



M-0679-03
Crown Remover
Complete with 3 points



M-0680-17
Crown Remover Forceps
17 cm

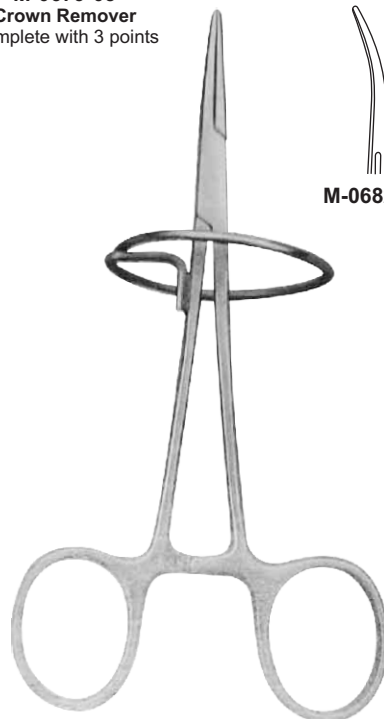

M-0681-00
Crown & Bridge Forceps
with support Ring



M-0682-00



M-0683-00
Crown Spreader, Crown Remover,
Special instrument for crown spreading
after separating, simple and safe operation



**M-0684-03
Crown Remover**
Complete with 3 points

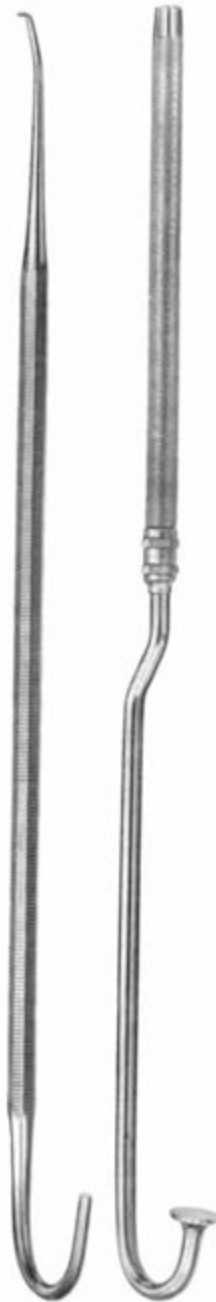

**M-0685-00
Treyman** 255 mm
**M-0686-03
Crown Remover**
Complete with 3 points

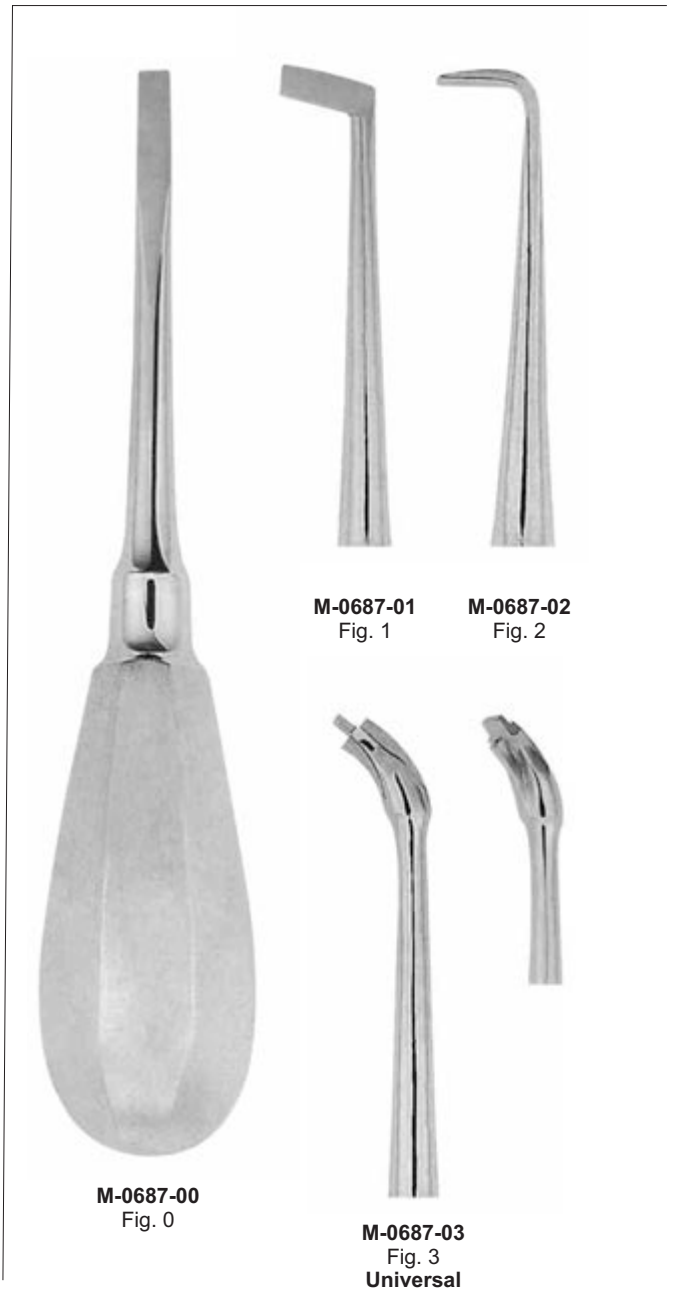

**M-0687-01
Fig. 1**

**M-0687-02
Fig. 2**

**M-0687-00
Fig. 0**

**M-0687-03
Fig. 3
Universal**

Available in European and American Both Threads



M-0700-01

Citoject Intraligamentary Syringe
Syringe Injections Intra Ligaments,
The Shape pen & The angled tip
allows easy positioning of the needle.
The leverage Multiplier offers comfort
for injection of the health practitioner.
10 times less pressure and 10 times less
anesthetic than any type of syringe

M-0700-02

Intraligamental Syringe deosy type
Intraligamental syringe (1.8ml,inch Thread)
Deosy type design, without undue operator
fatigue. one complete squeeze of theTrigger
releases one dose (0.2cc)



M-0700-03

Pistol type intraligamental syringe
black handle
1.8 ml

M-0700-04

Pistol type intraligamental syringe
mirror finish
1.8 ml



M-0700-05

Skyp-ject
Miniature intraligamental syringe 1.8ml



M-0700-06

Skyp-ject
Miniature intraligamental syringe 1.8ml



M-0700-07

Injects 0.05 ml with every click.
Easy attach / detach luer lock system.
Angled tip allows easy access to inject in difficult areas.
Special featured release button.



M-0700-08

Crutch Handle Cartridge
Syringe cartridge syringe
with three aspirating hooks,
Locking device & crutch
handle folding type
(square Rod)

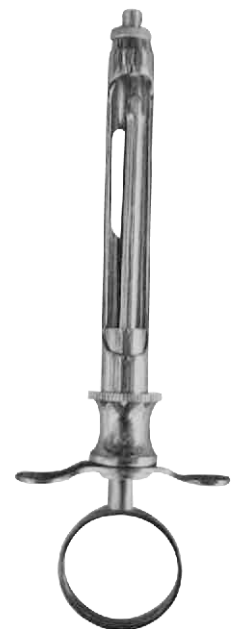

M-0700-09

Astra-Type (Cook-Waite)
Aspirating syringe with arrow
for Anesthesia with Metric / Us Thread.
Non Folding - Chromium
Plated Brass 1.8 CC & 2.2 CC



M-0688-00
Band Pusher
Mershon
145 mm



M-0689-00
Band Setter with tin
155 mm



M-0690-01
Telescope Crown Plier
140 mm, 6"



M-0690-02
Telescope Crown Plier
140 mm, 6"



M-0691-00
Cooper ring remover plier
Furrer
150 mm



M-0692-15
15 cm



M-0693-15
Miller



M-0694-00
Kirk



M-0695-07
Crown Slitter
Montfort
180 mm, 7"

Ampullenspritze Cartridge Syringes



Available in European and American Both Threads



M-0700-10
Flat Wing Non-Folding Type
Anesthesia syringe. Cylinder
without Aspiration Metric / Us
Thread - 1.8 CC & 2.2 CC

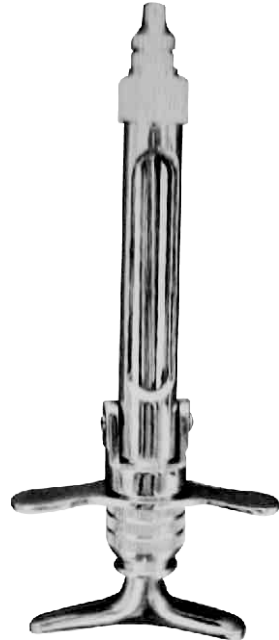

M-0700-11
Flat Wing Folding Type
Anesthesia syringe. Cylinder
without Aspiration Metric / Us
Thread - 1.8 CC & 2.2 CC



M-0700-12
Flat Wing Cartridge Syringe
for Anesthesia, folding type. Cylinder
without Aspiration Metric / Us
Thread. - 1.8 CC & 2.2 CC



M-0700-13
Flat Wing Folding Type
Anesthesia syringe. Cylinder
without Aspiration Metric / Us
Thread. chromium plated
Brass. - 1.8 CC & 2.2 CC



M-0700-14
3 Ring Cartridge Syringe for
Anesthesia -Non-Folding type
Available in Us / Metric Threads



M-0700-15
Articulated Syringe S-Type
Arpon Bayer for Anesthesia
Non folding- chromium
Plated Brass. Available in
Us / Metric Threads



M-0700-16
Aspirating Folding Cartridge
Syringe. chromium Plated
Brass. 1.8 CC & 2.2 CC
Available in Us/ Metric Thread



M-0700-17
Standard Syringe
1.8 ml
2.2 ml

Available in European and American Both Threads



M-0700-18
Aspirating Folding Syringe
strip Handle, single side
folding type chromium Plated
Brass. 1.8 CC & 2.2 CC
Available in Us/ Metric Thread



M-0700-19
Pro Miltex "A" (ASTRA) Type
Aspirating Syringe with Metric
/Us Threads. Non folding, retract
by pulling thumb ring back. Insert
cartridge, plunger end first into barrel.
Backward motion will produce
aspiration 1.8 CC & 2.2 CC



M-0700-20
Cork Screw Tip Aspirating
syringe for anesthesia, single
ring, Cylinder with Aspiration
Metric / us Thread-chromium
plated Brass. 1.8 CC & 2.2 CC



M-0700-21
Cork Screw Tip Aspirating
syringe for anesthesia, single
ring, Cylinder with Aspiration
Metric / us Thread-chromium
plated Brass. 1.8 CC & 2.2 CC



M-0700-22
Cartridge Syringe Cylinder
with Aspiration, Metric /Us
threads. Non folding- chromium
Plated brass. 1.8 CC & 2.2 CC



Single ring aspirating syringe
M-0700-23
1.8 ml
2.2ml



M-0700-24
Cook-waite Type Self Aspirating
Syringe, 1.8 CC & 2.2 CC
for Anesthesia, Light weight
Construction of Aluminium
& stainless steel. available
in Us / Metric threads &
Assorted colors handle



M-0700-25
Self Aspirating Aspiject Syringe
with saddle grip, for anesthesia
stainless steel & High Tech
polymer Construction which
allows it to be completely
Sterilizable

Ampullenspritze Cartridge Syringes

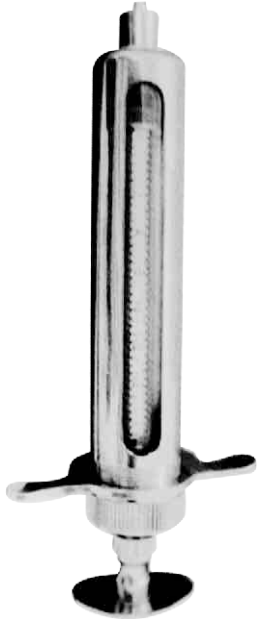

M-0700-26
Veterinary Metal Syringe made of copper & Finished by chromium plating. High Quality that it will stand the test of time. Designed for one hand operation & Are Easy to Disassemble & clean. Disinfect it in boiled water. 10ml 20ml 30ml 50 ml is Available



M-0700-27
Detail: Component from (I to V) are made of copper & finished by chromium plating **functions:** Mainly Used for animal Disease Prevention & Treatment by Vet **Not:** The Disinfection in boiled water is applicable for syringes. High-pressure steam disinfection is prohibited



M-0700-28
Veterinary Pisto Grip Pro-shot syringes Europles Metal gun syringe / Pro-shot 50 cc is Ruggedly built from Highimpact plastic to be both Durable. Transparent, Graduated Barrel, which will not discolor. Simple dosage sleeve can be Easily Adjusted from 1 to 5 Ccs. Non-adjustable nylon plunger assembly & A Luer Lock Hub. extremely Accurate Pro-shot 5 cc Pistol-grip syringe combines outstanding features



M-0700-29
Veterinary Syringe C-Type A Durable Plastic Syringe that will stand the test of time. Clear plastic Barrel, Black inscribed Graduations & orange Handles. Syringes have luer-lock luer-slip Needle Holder & are Autoclavable up to 150 Available in 10 m, 20ml,30ml 50ml, & 100ml



M-0700-29
Reiner Ear Syringe with 3 Cannulas & 1 Protecting Disk, Available in 50ml, 75ml,100ml & 150ml



M-0700-30
Aqua-fix Irrigating Self Filling Water Syringe (all Metal) for Ear.



M-0700-31
Ear Syringe with Spring Chrome plated

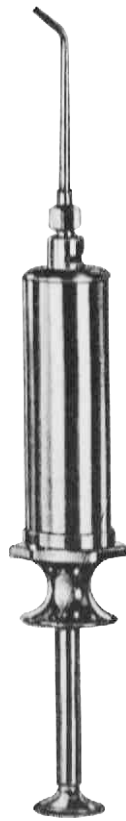

M-0701-00



M-0701-01



M-0702-00



M-0702-01



M-0703-01
without Valve



M-0703-02
with Valve

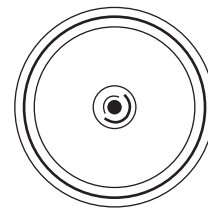

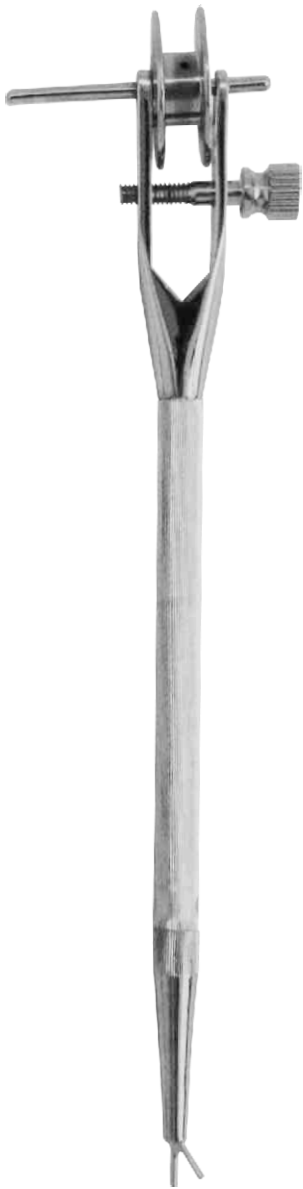

M-0704-00
Ligature Instrument

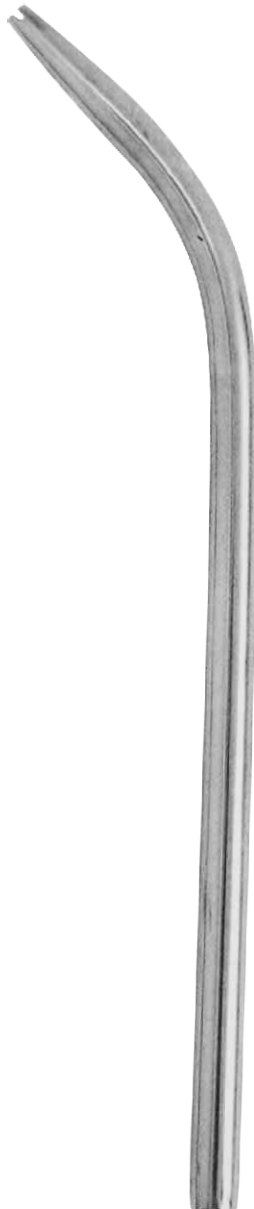

M-0705-03 Ø3 mm
M-0705-04 Ø4 mm
M-0705-05 Ø5 mm
Saliva Ejectors
18 cm

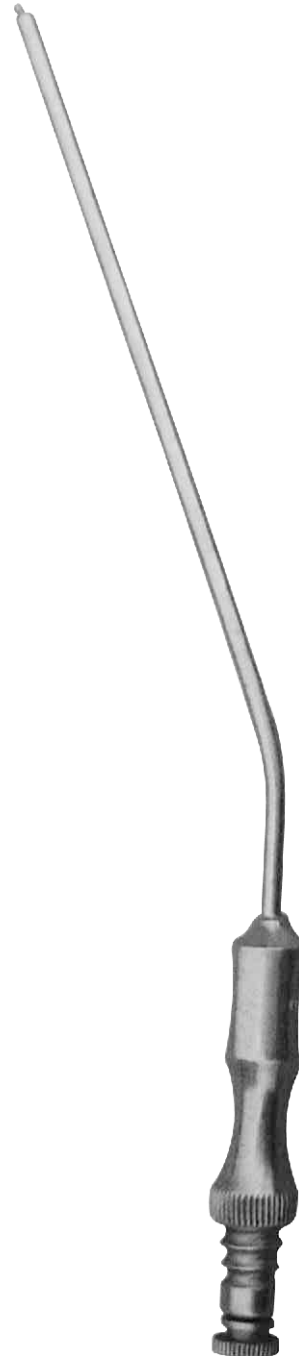

Frazier (Fergusson)

- | | | |
|------------------|--------------------|-----------|
| M-0706-06 | Charr./Fr6 | Ø 2.00 mm |
| M-0706-06 | Charr./Fr8 | Ø 2.66 mm |
| M-0706-06 | Charr./Fr10 | Ø 3.33 mm |
| M-0706-06 | Charr./Fr12 | Ø 4.00 mm |

18 cm



M-0710-01
Mini-Regular



M-0711-01
Grande-Regular



M-0712-01
Jumbo-Regular



M-0713-01
Mini-Distal



M-0714-01
Regular-Distal



M-0715-01
Grande-Distal



M-0716-01
SINGLE-END



M-0717-01
Regular
SINGLE-END



M-0718-01
Grande
SINGLE-END

**Amalgam-Pistolen
Amalgam Carriers**



**M-0719-01
Ivory**
210 mm



**M-0720-01
with metal tip**
185 mm



M-0721-00



**M-0721-01
with metal tip**
135 mm



**M-0721-02
with metal tip**
145 mm



**M-0722-01
Amalgam Wells**
ø 3.5 cm
h 4 cm



**M-0722-02
Amalgam Wells**
ø 2 cm
h 2.5 cm



**M-0722-03
Amalgam Wells**
ø 3 cm
h 2.0 cm



**M-0722-04
Amalgam Wells**
ø 3.5 cm
h 3.5 cm



M-0722-05



SEGITECH

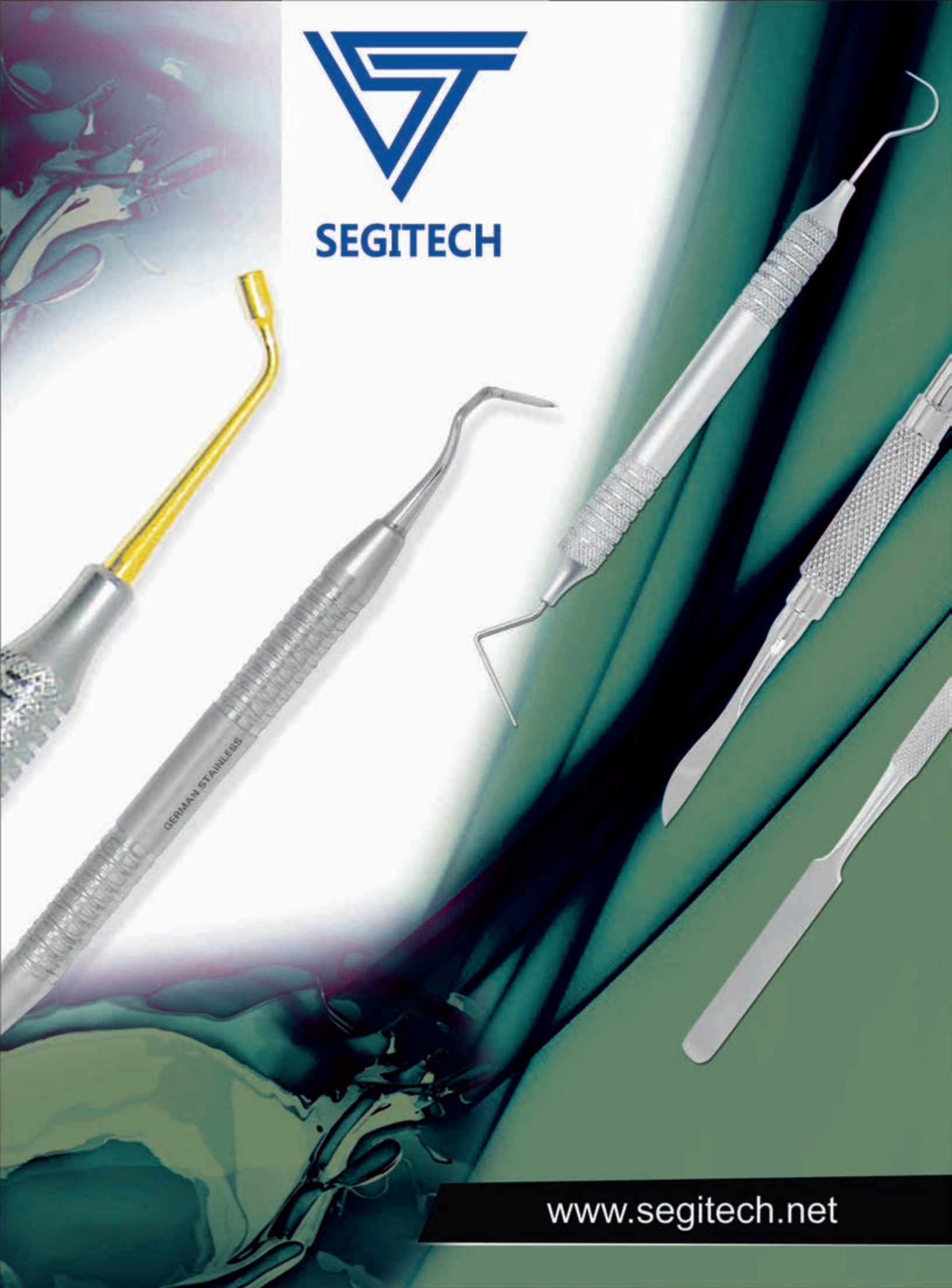

www.segitech.net

Sonde Millimetriche Paradontali Periodontal Pocket Probes

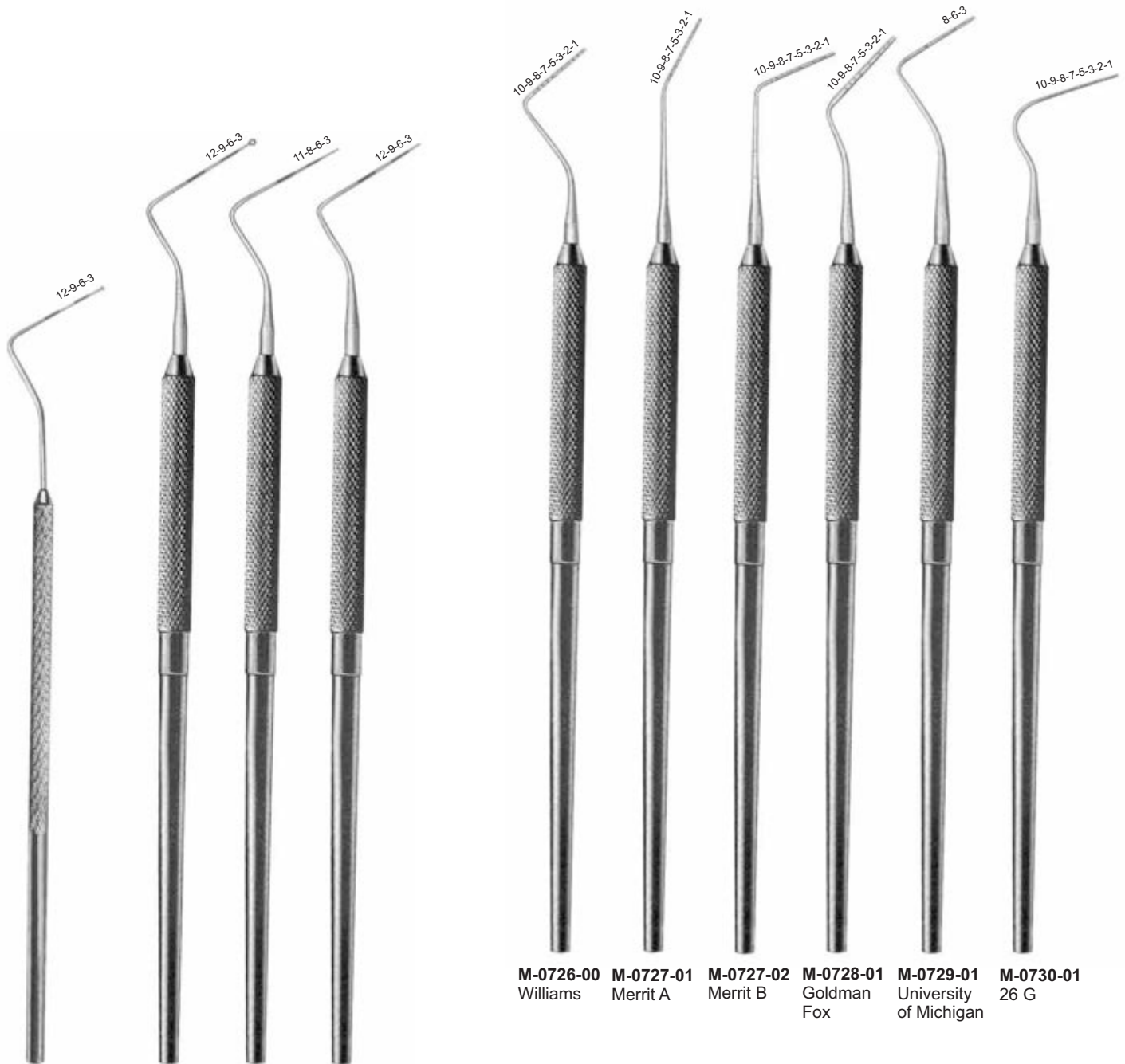

M-0725-01
Fig. CP-C

M-0725-02
CP-12S
O.M.S.

M-0725-03
CP-11

M-0725-04
CP-12

M-0726-00
Williams

M-0727-01
Merrit A

M-0727-02
Merrit B

M-0728-01
Goldman
Fox

M-0729-01
University
of Michigan

M-0730-01
26 G

10-9-8-7-5-3-2-1



M-0731-01
Goldman-Fox / Williams



M-0732-01
Fig. 1N
Nabers



M-0732-02
Fig. 2N
Nabers



M-0733-01
Fig. UT 1/2
Cattoni

**Sonden-Paradibtineter-Kombination
Combination Explorer-Probes**

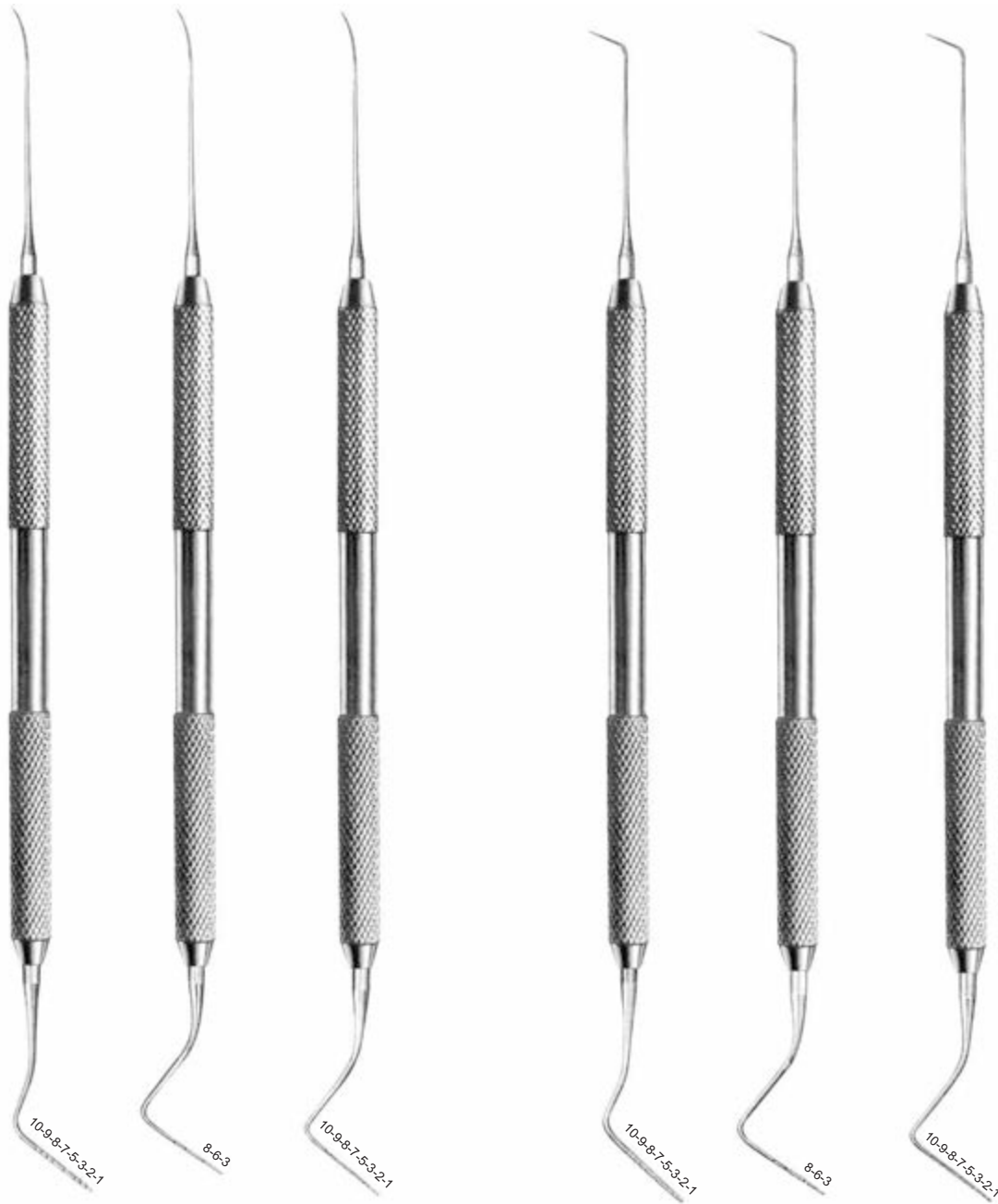

M-0734-03
Fig. 3
Goldman-Fox

M-0735-03
Fig. 3
University of
Michigan

M-0736-03
Fig. 3
Williams

M-0737-16
Fig. 16
Goldman-Fox

M-0738-06
Fig. 16
University of
Michigan

M-0739-16
Fig. 16
Williams



M-0740-23
Fig. 23
Goldman-Fox

M-0741-23
Fig. 23
University of Michigan

M-0742-23
Fig. 23
Williams



M-0743-17
Fig. 17
Goldman-Fox

M-0744-17
Fig. 17
University of Michigan

M-0745-17
Fig. 17
Williams



M-0746-01
Fig. 23/CP11
Williams

M-0746-02
Fig. 23/CP12
Williams



M-0747-01 Fig. 1 Luks
M-0747-02 Fig. 2 Luks
M-0747-03 Fig. 3 Luks
M-0747-04 Fig. 4 Luks

Wurzelkanalstopfer
Root-canal pluggers

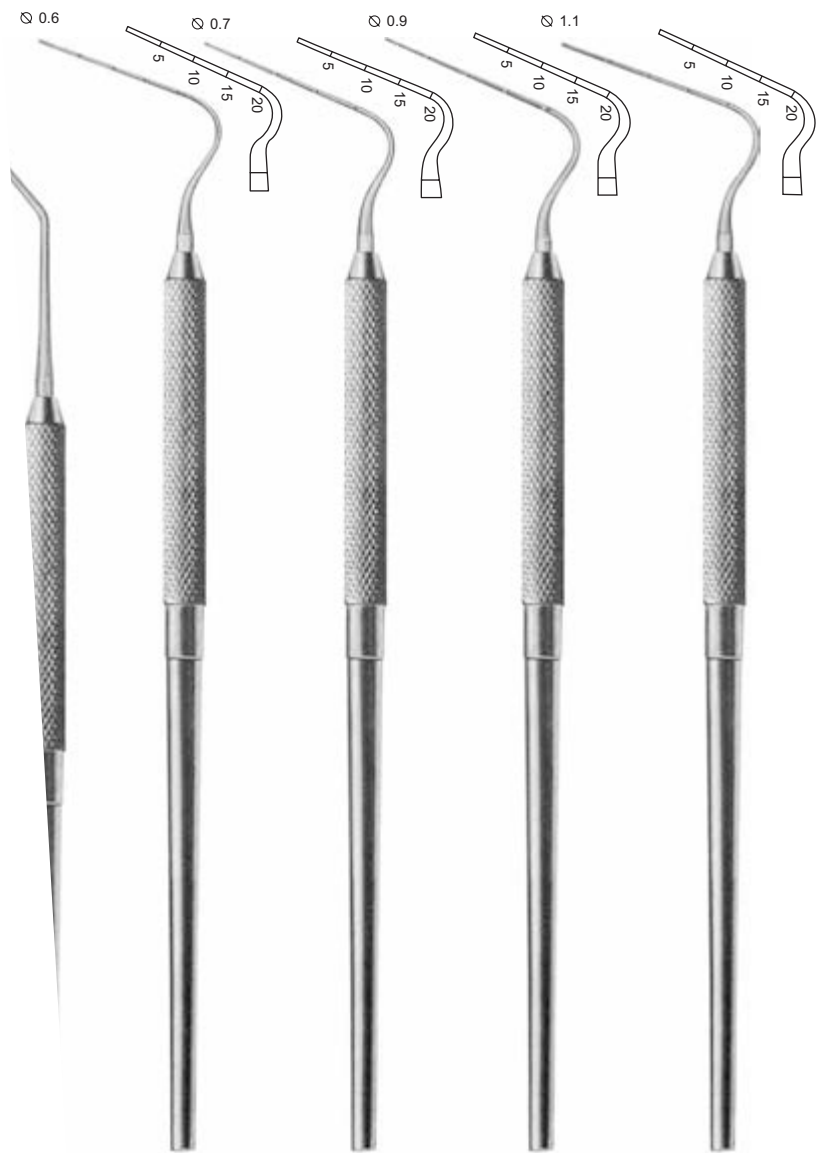

M-0748-01 Fig. 1 vertical condenser
M-0748-02 Fig. 2 vertical condenser
M-0748-03 Fig. 3 vertical condenser
M-0748-04 Fig. 4 vertical condenser



M-0749-01
Fig. 1
Spreader

M-0749-02
Fig. 2
Spreader

M-0749-03
Fig. 3
Spreader

M-0749-04
Fig. 4
Spreader

M-0749-05
Fig. 5
Spreader

M-0749-06
Fig. 6
Spreader

M-0749-07
Fig. 7
Spreader

**Nervinstrynebte
Endodontic Instruments**



**M-0750-01
Thuerriegel
1-6**



**2
M-0750-02**



**3
M-0750-03**



**4
M-0750-04**



**5
M-0750-05**



**6
M-0750-06**

Thuerriegel

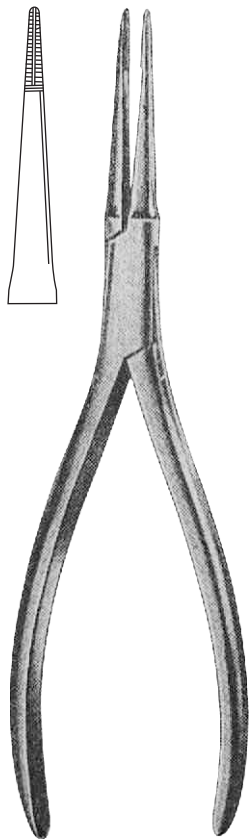

**M-0751-15
15 cm**

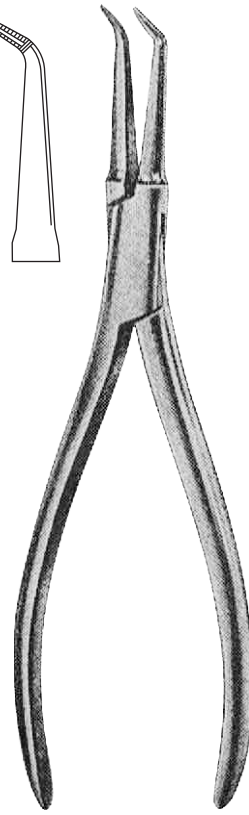

**M-0752-15
15 cm**



**1
M-0753-01**

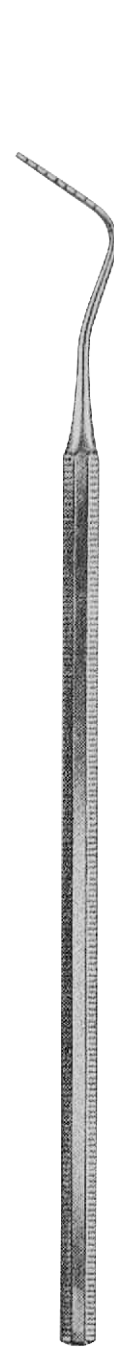

**2
M-0753-02**



**1
M-0754-01**

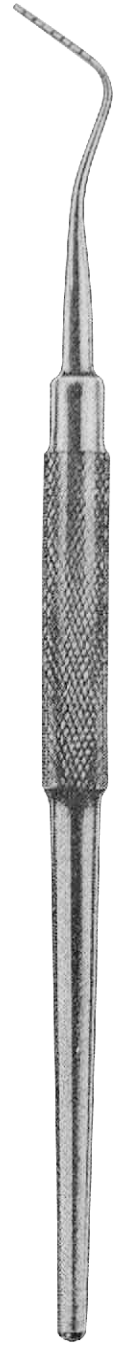

**2
M-0754-02**

Williams



M-0755-01

M-0755-02

M-0755-03

M-0755-04

M-0755-05

Zahnsonden
Probes And Explorers



M-0756-01
Fig.1



M-0756-02
Fig.2



M-0756-03
Fig.3



M-0756-05
Fig.5



M-0756-06
Fig.6



M-0756-07
Fig.7



M-0756-09
Fig.9



M-0756-10
Fig.10



M-0756-11
Fig.11



M-0756-12
Fig.12



M-0756-13
Fig.13



M-0756-14
Fig.14



M-0756-17
Fig.17



M-0756-18
Fig.18



M-0756-20
Fig.20



M-0756-21
Fig.21



M-0756-22
Fig.22



M-0756-23
Fig.23



M-0756-42
Fig.42



M-0756-43
Fig.43



M-0756-44
Fig.44



M-0756-45
Fig.45

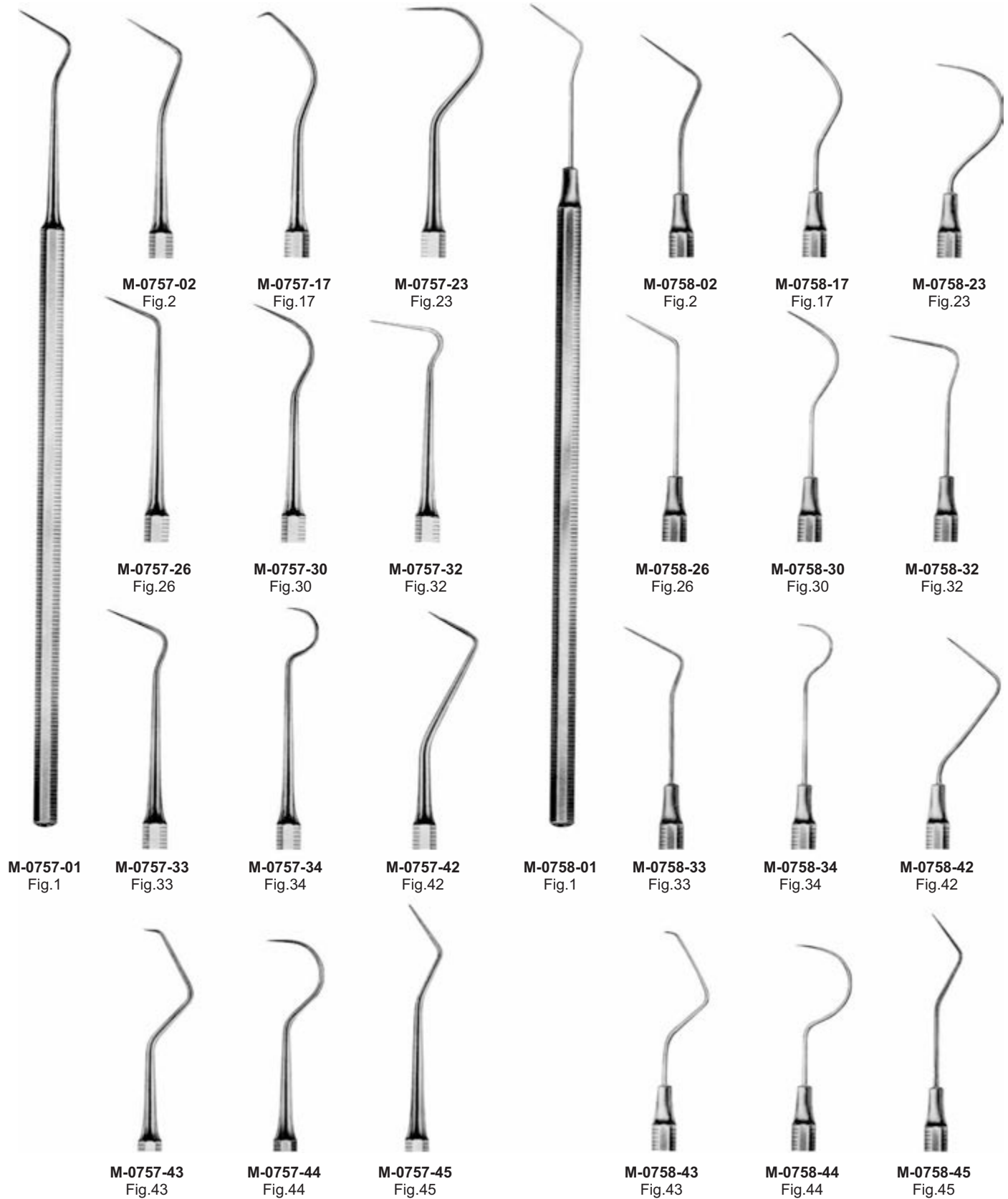

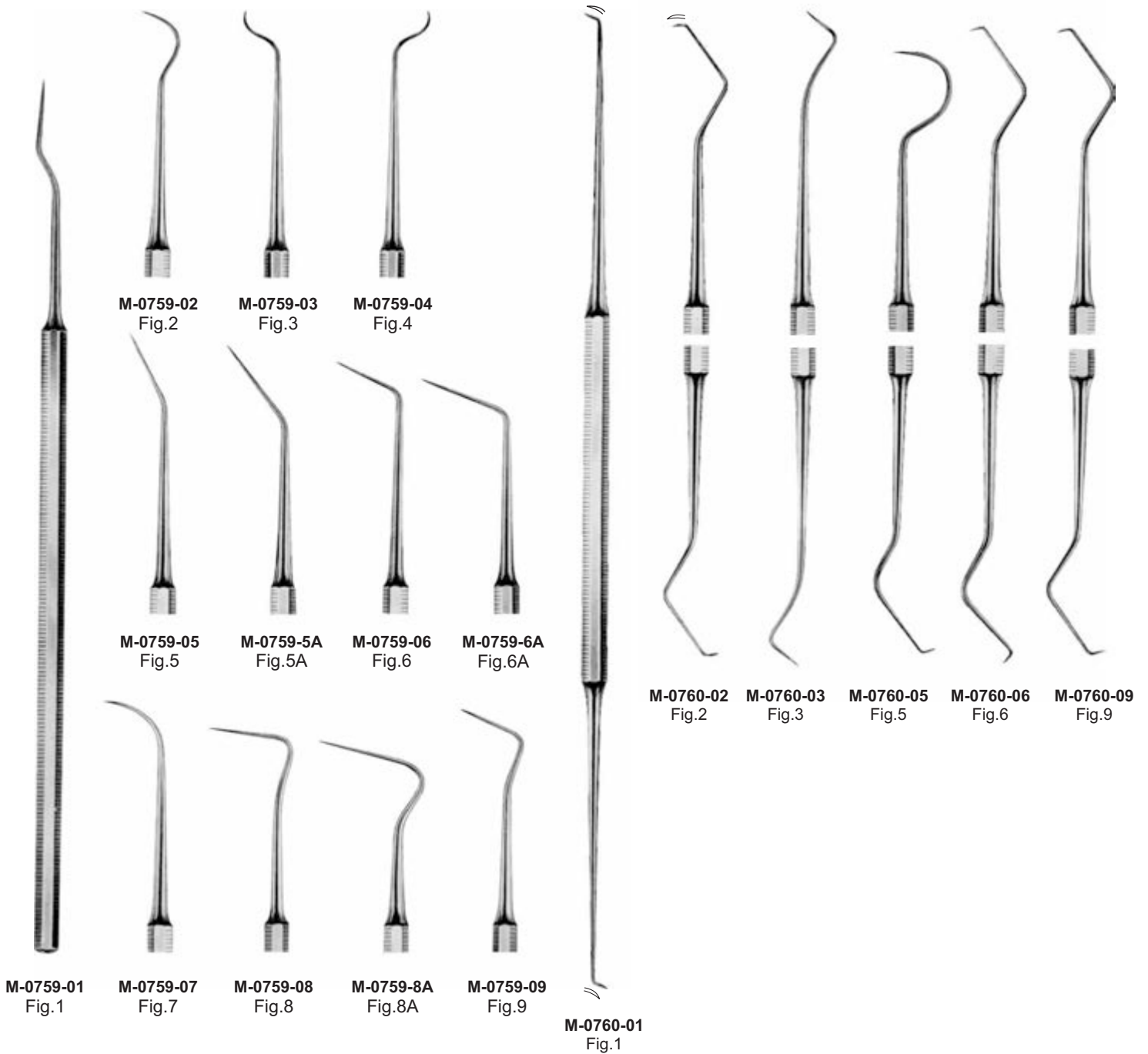



M-0761-01
Fig.1



M-0761-02
Fig.2



M-0761-03
Fig.3



M-0762-01
Fig.1
Weston



M-0762-02
Fig.2
Weston

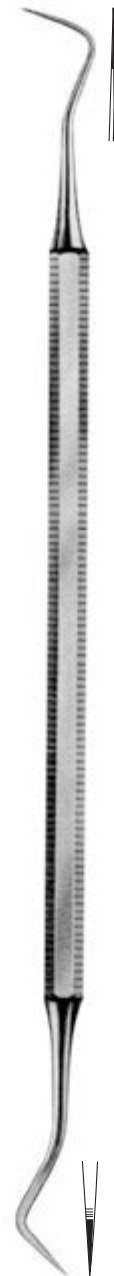

M-0763-01
Fig.1
Lange



M-0763-02
Fig.2
Lange

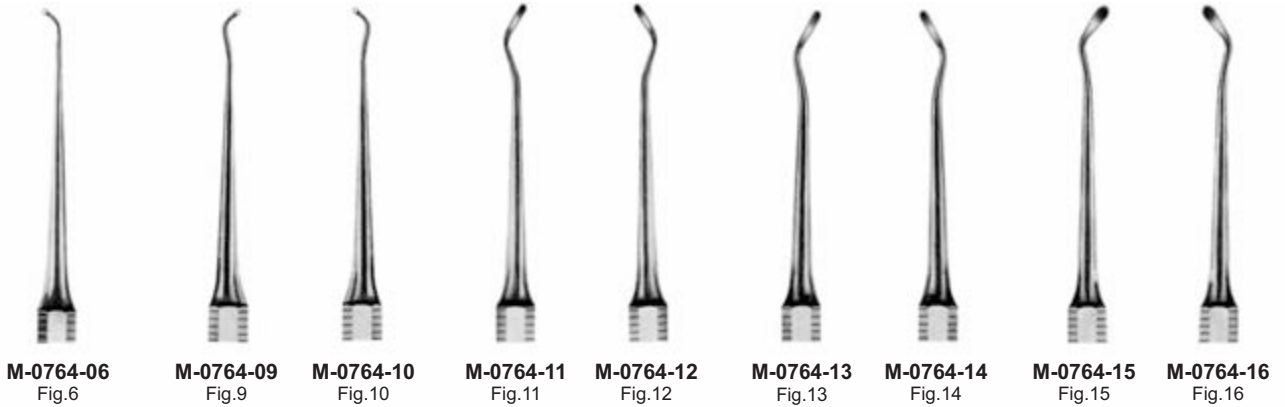

Darby-Perry

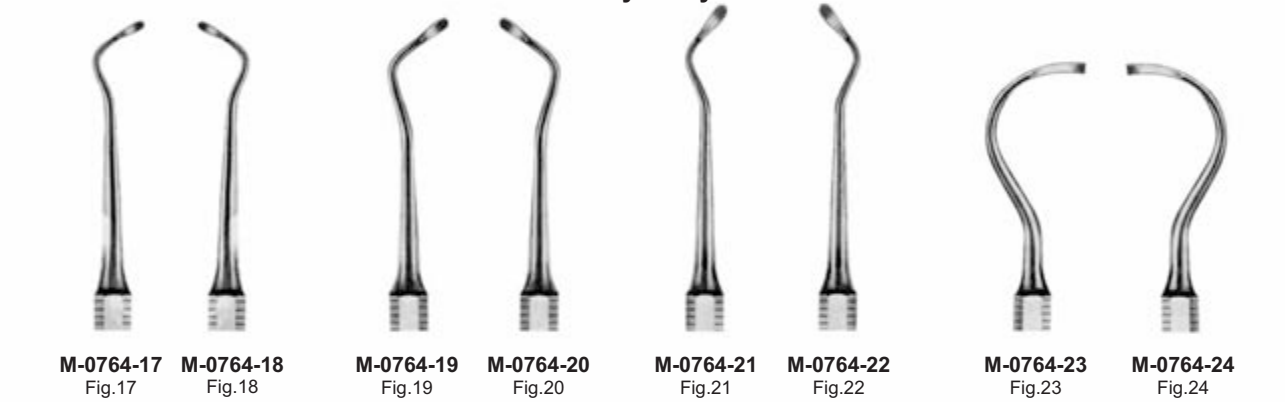

Darby-Perry



M-0764-05 Fig.5
Darby-Perry

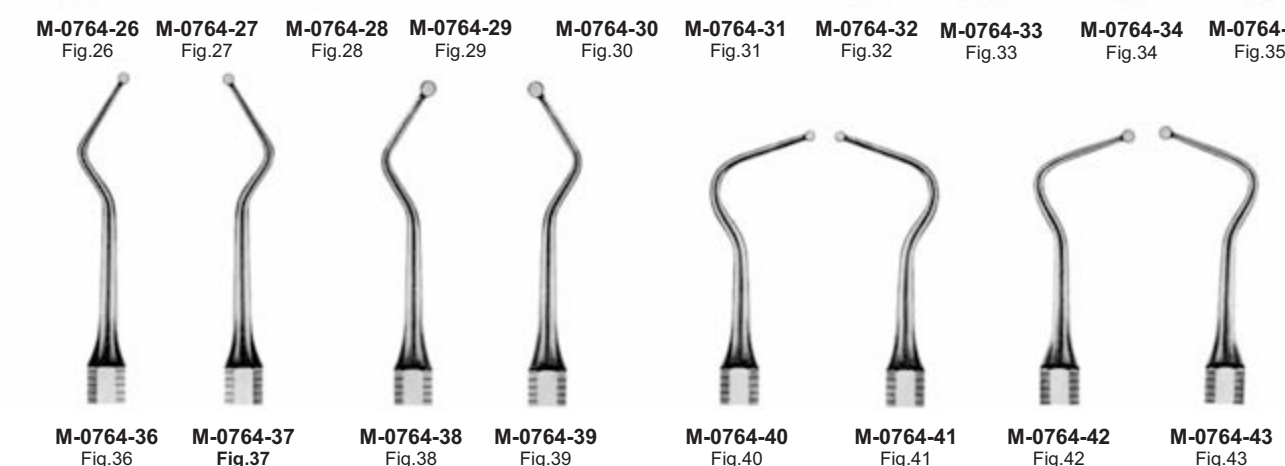



M-0765-01
Fig.131/132



M-0765-02
Fig.133/134



M-0765-03
Fig.155/156



M-0766-01
Fig.243
Gillet



M-0766-02
Fig.244
Gillet



M-0766-03
Fig.245
Gillet



M-0766-04
Fig.246
Gillet



M-0767-01
Fig.19/20

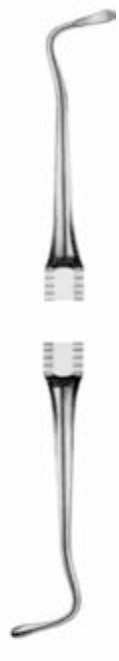

M-0767-02
Fig.17/18

— Darby-Perry —



M-0767-03
Fig.204/5



M-0767-04
Fig.206/7



M-0767-05
Fig.208/9



M-0767-05
Fig.210/11



M-0767-06
Fig.212/3



M-0767-07
Fig.214/5



M-0767-08
Fig.216/7



M-0767-09
Fig.218/9



M-0767-10
Fig.220/21

— Darby-Perry —



M-0768-14
Fig.14
White



M-0768-17
Fig.17
White



M-0768-18
Fig.18
White

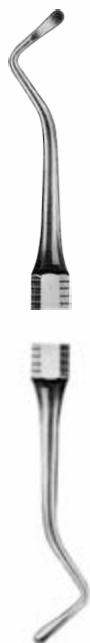

M-0769-02
Fig.73/74



M-0769-03
Fig.74/111



M-0769-04
Fig.111/112



M-0769-05
Fig.113/114



M-0769-06
Fig.115/116



M-0769-07
Fig.117/118

M-0768-05
Fig.5
White

M-0768-19
Fig.19
White

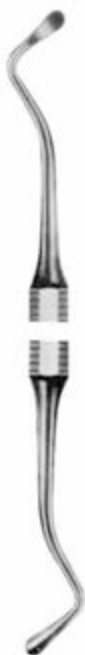

M-0768-20
Fig.20
White



M-0769-01
Fig.72/73



M-0769-08
Fig.119/120



M-0769-09
Fig.121/122



M-0769-10
Fig.123/124



M-0769-11
Fig.125/126



M-0769-12
Fig.127/128



M-0769-13
Fig.129/130



Note: Any one of the below handles can be choosed for hand instruments just by giving reference of any required HANDLE



M-0770-01
Octa-Classic
Solid handle \varnothing 5.5 mm



M-0770-02
Slim-Action
Solid handle \varnothing 5.5 mm



M-0770-03
Cobra-Series
Hollow handle \varnothing 8 mm



M-0770-04
Ring-O-Lite
Hollow handle \varnothing 8 mm



M-0770-05
Feather Feel
Hollow handle \varnothing 8 mm



M-0770-06
Dura ring- Series
Hollow handle \varnothing 8 mm



M-0770-07
Soft Hold
Hollow handle \varnothing 8 mm



M-0770-08
Max Grip
Hollow handle \varnothing 8 mm

Note: Any one of the below handles can be chosen for hand instruments just by giving reference of any required HANDLE



M-0770-09
Hollow Diamond handle



M-0770-10
Plane handle



M-0770-11
Hu-friedy
handle



M-0770-12
USA Model
handle



M-0770-13
Hollow Medesy
handle



M-0770-14
Hollow handle

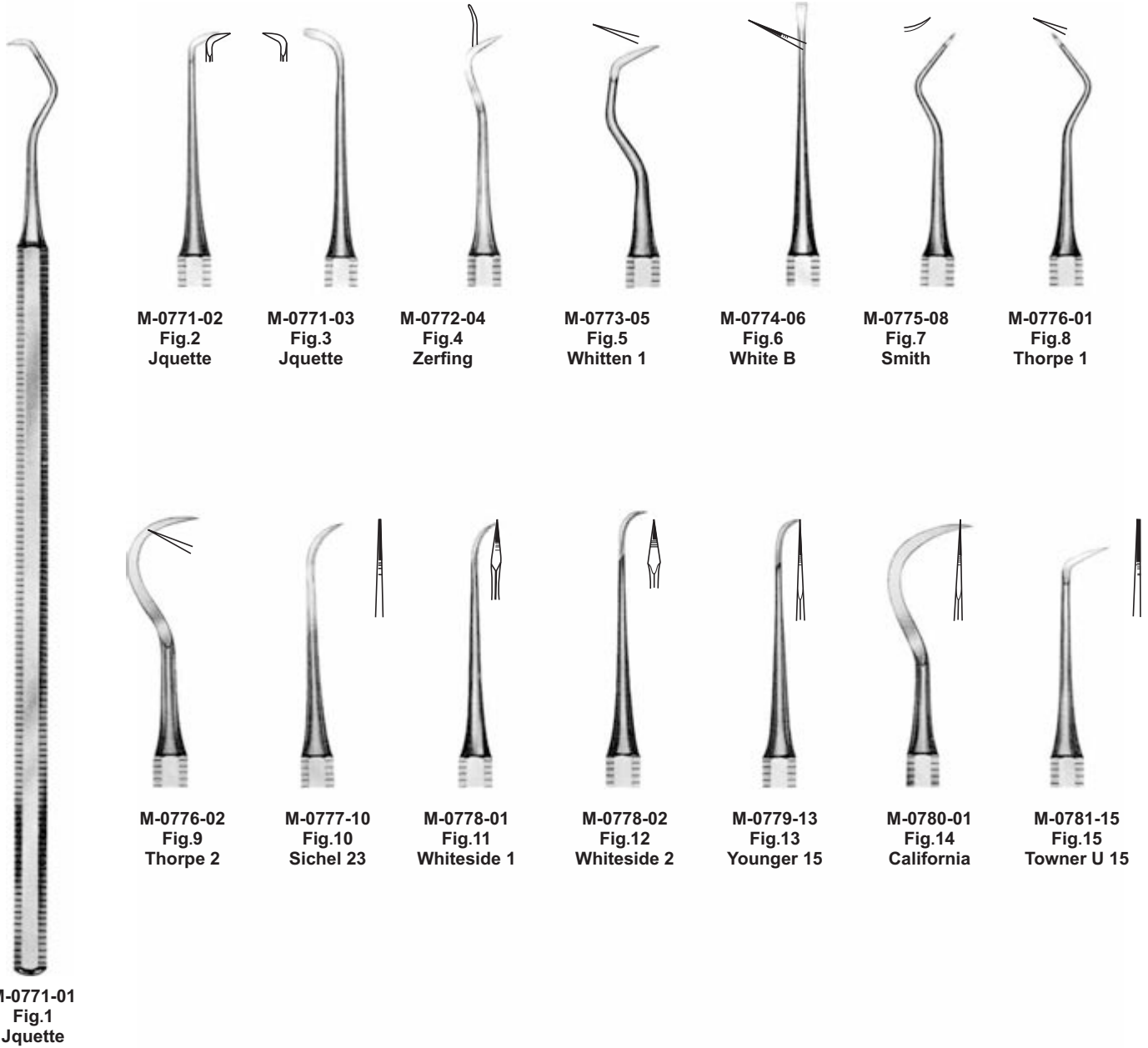

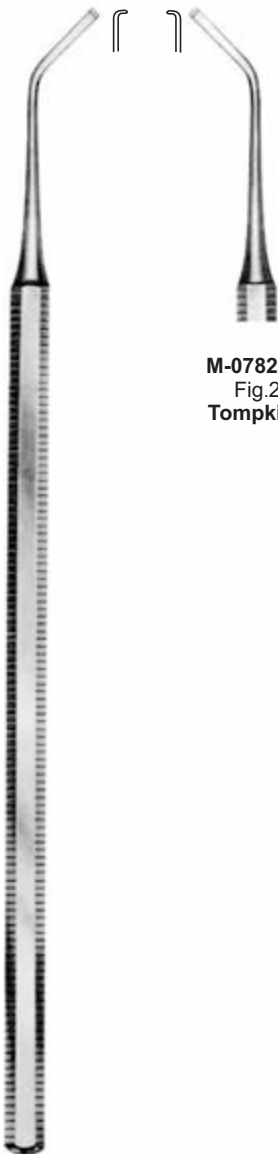

M-0782-01
Fig.1
Tompkins

M-0782-02
Fig.2
Tompkins

M-0782-03
Fig.3
Tompkins

M-0782-04
Fig.4
Tompkins

M-0782-05
Fig.5
Tompkins

M-0782-06
Fig.6
Tompkins

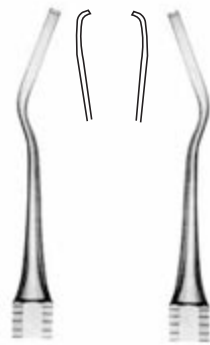

M-0782-07
Fig.11
Tompkins

M-0782-08
Fig.12
Tompkins



M-0782-09
Fig.11
Tompkins



M-0782-10
Fig.12
Tompkins



M-0783-01
Fig.1
Black



M-0783-02
Fig.2
Black



M-0783-03
Fig.3
Black



M-0783-04
Fig.4
Black



M-0783-05
Fig.5
Black



M-0783-06
Fig.6
Black



M-0783-07
Fig.7
Black



M-0783-08
Fig.8
Black



M-0783-09
Fig.9
Black



M-0783-10
Fig.10
Black



M-0783-11
Fig.11
Black



M-0783-12
Fig.12
Black



M-0784-01
Fig.1
Abbott



M-0784-02
Fig.2
Abbott



M-0784-03
Fig.3
Abbott



M-0784-04
Fig.4
Abbott



M-0785-01
Fig.1
Scharmann



M-0785-02
Fig.2
Scharmann



M-0785-03
Fig.3
Scharmann



M-0785-04
Fig.4
Scharmann



M-0785-05
Fig.5
Scharmann



M-0785-06
Fig.6
Scharmann



M-0785-07
Fig.7
Scharmann



M-0785-08
Fig.8
Scharmann



M-0786-13
Fig.13
Younger-Good



M-0786-14
Fig.14
Younger-Good



M-0786-15
Fig.15
Younger-Good



M-0787-05
Fig.5
Hygienist



M-0787-06
Fig.6
Hygienist



M-0787-07
Fig.7
Hygienist



M-0787-08
Fig.8
Hygienist



M-0787-09
Fig.9
Hygienist



M-0788-01
Fig.2 L



M-0788-02
Fig.2 R



M-0788-03
Fig.4 L



M-0788-04
Fig.4 R



M-0789-01
Fig.5
Muehleemann



M-0789-02
Fig.6
Muehleemann



M-0790-01
Fig.1
White



M-0790-02
Fig.2
White



M-0790-03
Fig.3
White



M-0790-04
Fig.4
White 12 B



M-0791-05
Fig.5
Cleveland

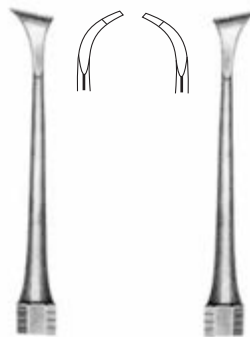

M-0792-01
Fig.6
More



M-0792-02
Fig.7
More



M-0793-01
Fig.1
Guy



M-0793-02
Fig.2
Guy



M-0793-03
Fig.3
Guy



M-0794-01
Fig.4
Wiolliger



M-0794-02
Fig.5
Wiolliger



M-0794-03
Fig.6
Wiolliger



M-0794-07
Fig.7
Wiolliger



M-0795-08
Fig.8
Fehr



M-0796-09
Fig.9



M-0797-10
Fig.10



M-0798-11
Fig.11
Cushing



M-0798-12
Fig.12
Cushing



M-0799-13
Fig.13

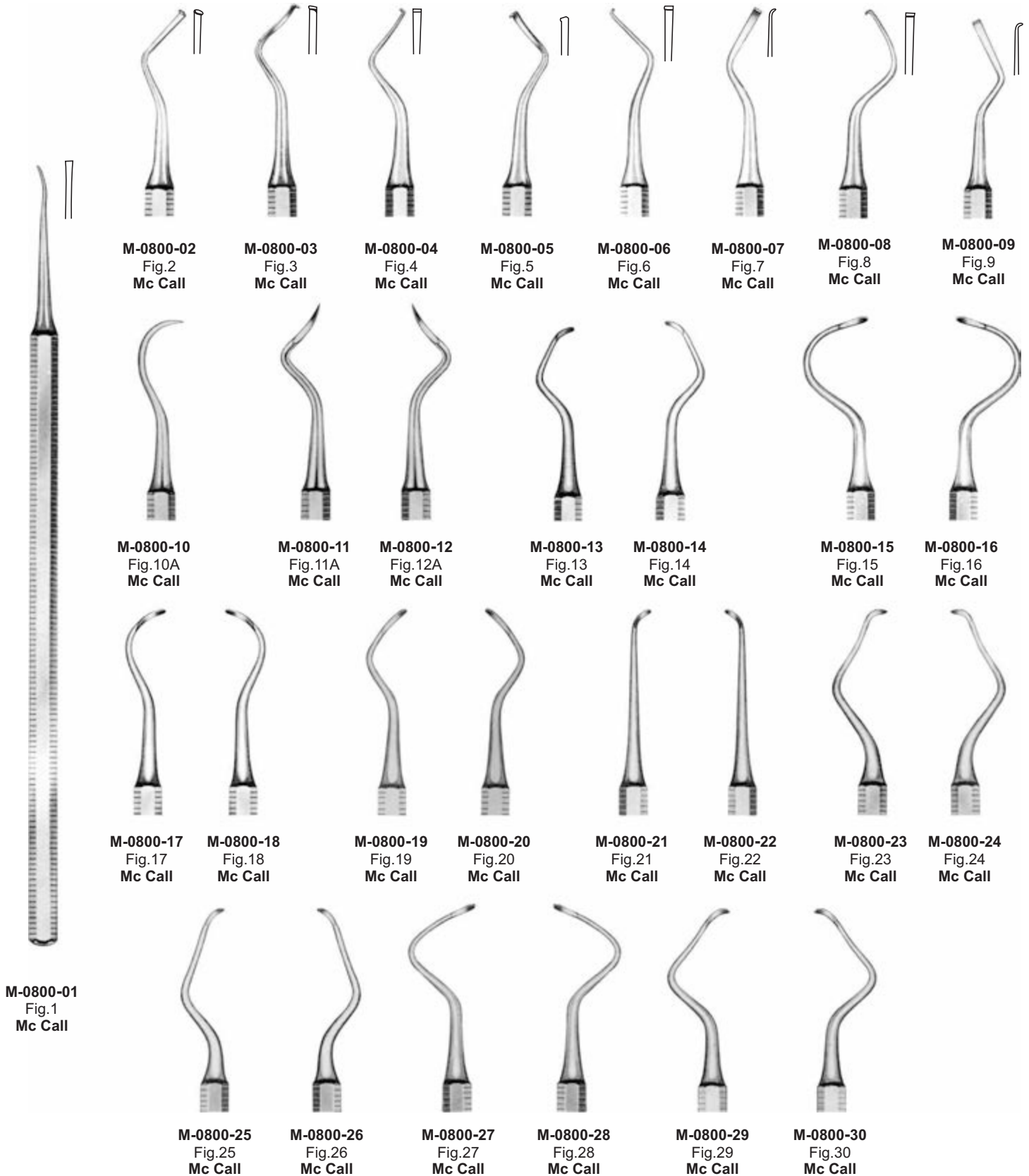

Zahnreiner Und Parodontal-Kurett Scalers And Periodontal Curettes



M-0801-01
Fig.1
Muehleemann



M-0801-02
Fig.02
Williger



M-0801-03
Fig.03
Black



M-0801-04
Fig.04
Senns

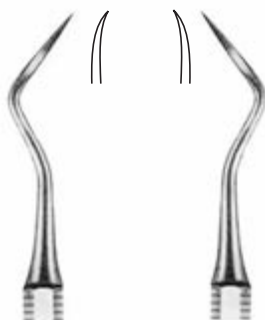

M-0801-05
Fig.5
Muehleemann



M-0801-06
Fig.6
Muehleemann

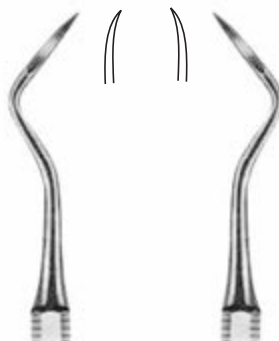

M-0801-07
Fig.7
Muehleemann



M-0801-08
Fig.8
Muehleemann

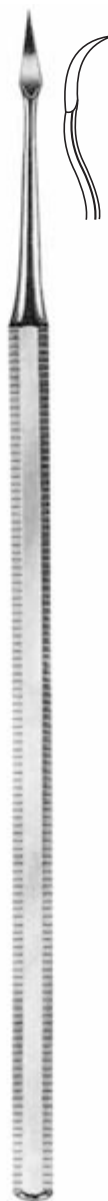

M-0803-01
Fig.1
Kirkland



M-0803-02
Fig.2
Kirkland



M-0803-03
Fig.3
Kirkland



M-0803-04
Fig.4
Kirkland



M-0803-05
Fig.5
Kirkland



M-0802-01
Fig.2 L



M-0802-02
Fig.2 R



M-0802-03
Fig.4 L



M-0802-04
Fig.4R



M-0804-01
Fig.5
Muehleemann



M-0804-02
Fig.6
Muehleemann



M-0805-01
Fig.16
Jaquette



M-0805-02
Fig.17
Jaquette



M-0805-03
Fig.18
Jaquette



M-0806-19
Fig.19
Haubeil



M-0807-20
Fig.20

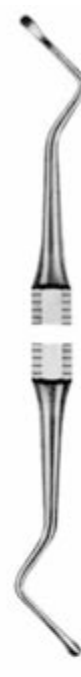

M-0808-01
Fig.21
Younger-Good



M-0808-02
Fig.22
Younger-Good



M-0809-23
Fig.23
Gethro



M-0810-24
Fig.24
Remington



M-0811-01
Fig.25
Baylor



M-0811-02
Fig.26
Baylor



M-0812-27
Fig.27
Muehleemann



M-0813-28
Fig.28
Black



M-0814-29
Fig.29



M-0815-30
Fig.30



M-0816-01
Fig.1
Cumine



M-0817-02
Fig.2
Mitchell



M-0818-03
Fig.3
Guenther



M-0819-01
Fig.4
Fehr



M-0819-02
Fig.5
Fehr



M-0820-01
Fig.6



M-0820-02
Fig.7



M-0820-03
Fig.8



M-0820-04
Fig.9



M-0820-05
Fig.10



M-0820-06
Fig.11



M-0820-07
Fig.12

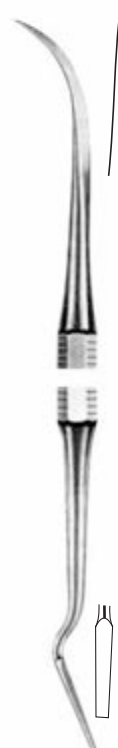

M-0821-01
Fig.13
Globe



M-0821-02
Fig.14

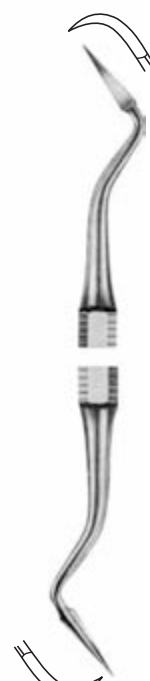

M-0821-03
Fig.15

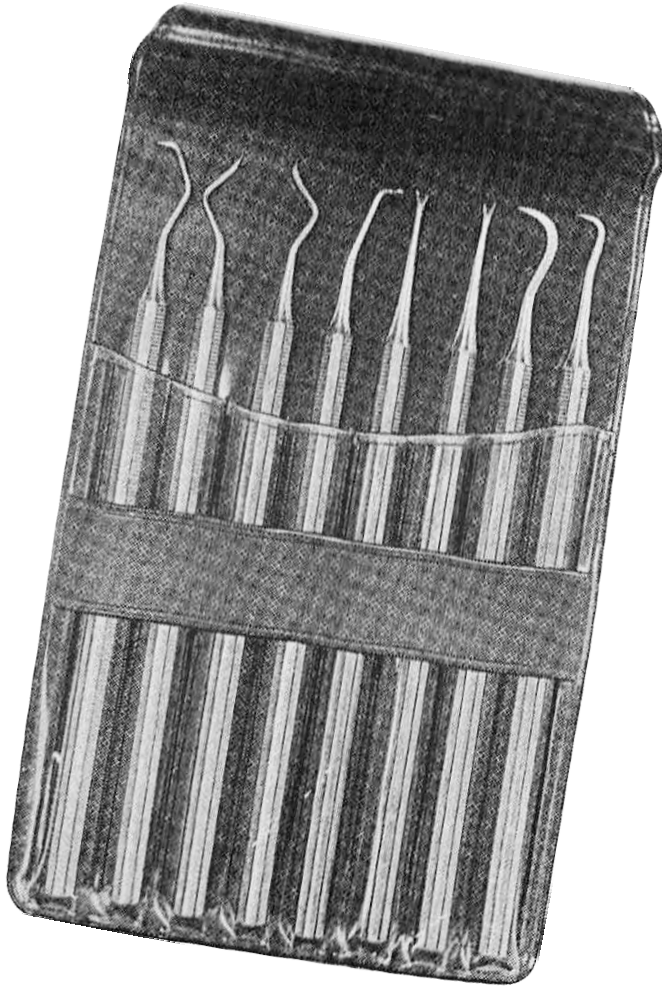

M-0822-00
Set of Scalers, comprising
Figs, M-0823-01 to M-0823-08
black plastic wallet



M-0823-01
Fig.1



M-0823-02
Fig.2



M-0823-03
Fig.3



M-0823-04
Fig.4



M-0823-05
Fig.5



M-0823-06
Fig.6



M-0823-07
Fig.7



M-0823-08
Fig.8

**Instruments A Detartreer
Scalers Kit**

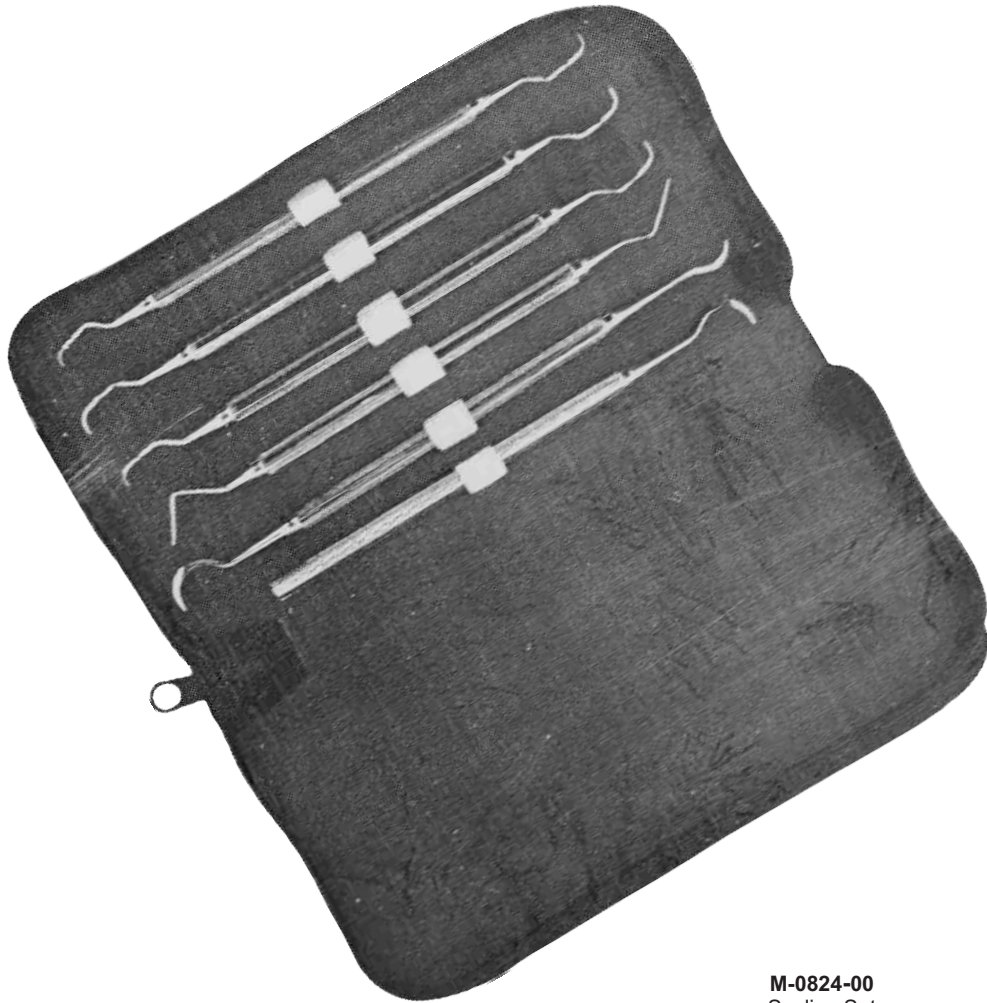

M-0824-00
Scaling Set

- 1- Goldman fox pocket probe, double ended
- 2- Jaquette scaler , single ended # 15
- 3- Jaquette scaler , double ended # U15/33
- 4- Langer curette, double ended # L 1/2
- 5- Langer curette, double ended # L 3/4
- 6- Langer curette, double ended # L 5/6



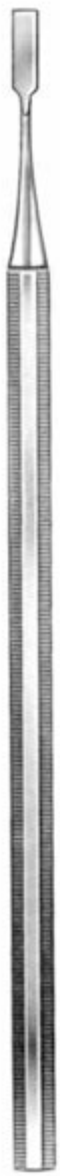

White

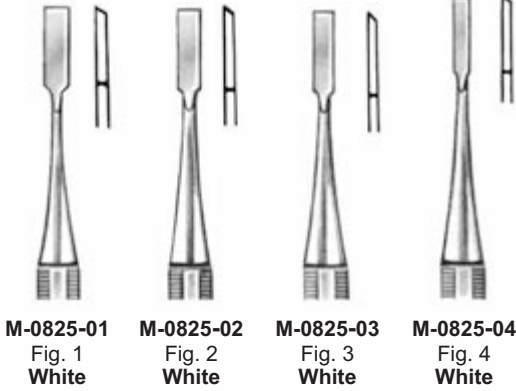

M-0825-01
Fig. 1
White

M-0825-02
Fig. 2
White

M-0825-03
Fig. 3
White

M-0825-04
Fig. 4
White

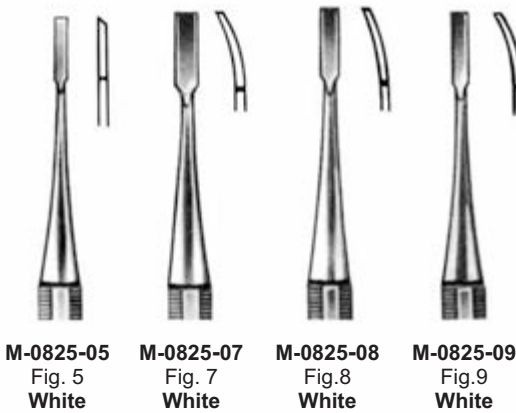

M-0825-05
Fig. 5
White

M-0825-07
Fig. 7
White

M-0825-08
Fig. 8
White

M-0825-09
Fig. 9
White

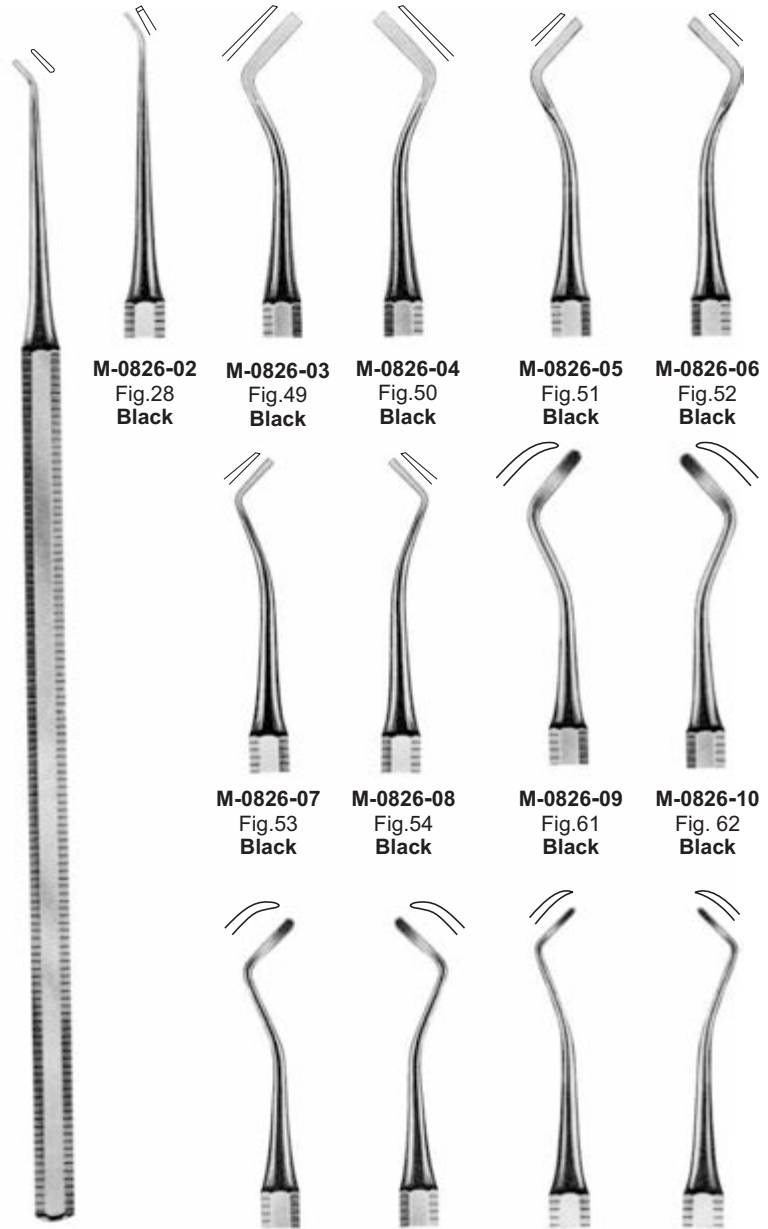

M-0826-02
Fig. 28
Black

M-0826-03
Fig. 49
Black

M-0826-04
Fig. 50
Black

M-0826-05
Fig. 51
Black

M-0826-06
Fig. 52
Black

M-0826-07
Fig. 53
Black

M-0826-08
Fig. 54
Black

M-0826-09
Fig. 61
Black

M-0826-10
Fig. 62
Black

M-0826-11
Fig. 10
Black

M-0826-11
Fig. 63
Black

M-0826-12
Fig. 64
Black

M-0826-13
Fig. 65
Black

M-0826-14
Fig. 66
Black



Black



M-0827-01
Fig.73
Black



M-0827-02
Fig.74
Black



M-0827-03
Fig.75
Black



M-0827-04
Fig.76
Black



M-0827-05
Fig.77
Black



M-0827-06
Fig.78
Black



M-0827-07
Fig.79
Black



M-0827-08
Fig.80
Black



M-0827-09
Fig.81
Black



M-0827-10
Fig.85
Black



M-0827-11
Fig.90
Black



M-0827-12
Fig.93
Black

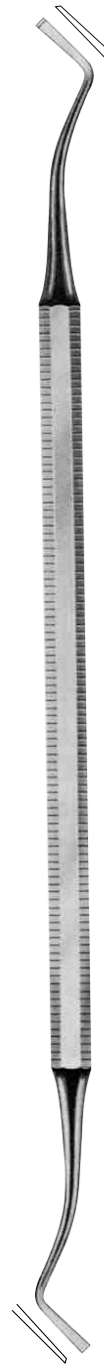

M-0828-01
Fig.51-52
Black



M-0828-02
Fig.77-78
Black



M-0828-03
Fig.79-80
Black



M-0828-04
Fig.89-92
Black



Black



M-0829-01
Fig.0
Black



M-0829-02
Fig.1
Black



M-0829-03
Fig.2
Black



M-0829-04
Fig.3
Black



M-0829-05
Fig.4
Black



M-0829-06
Fig.5
Black



M-0829-07
Fig.6
Black



M-0829-08
Fig.7
Black

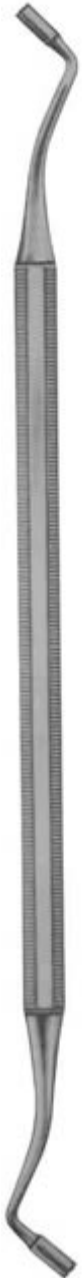

Black(Haubeil)



M-0830-01
Fig. 1
Black(Haubeil)



M-0830-02
Fig. 2
Black(Haubeil)



M-0830-03
Fig. 3
Black(Haubeil)



M-0830-04
Fig. 4
Black(Haubeil)



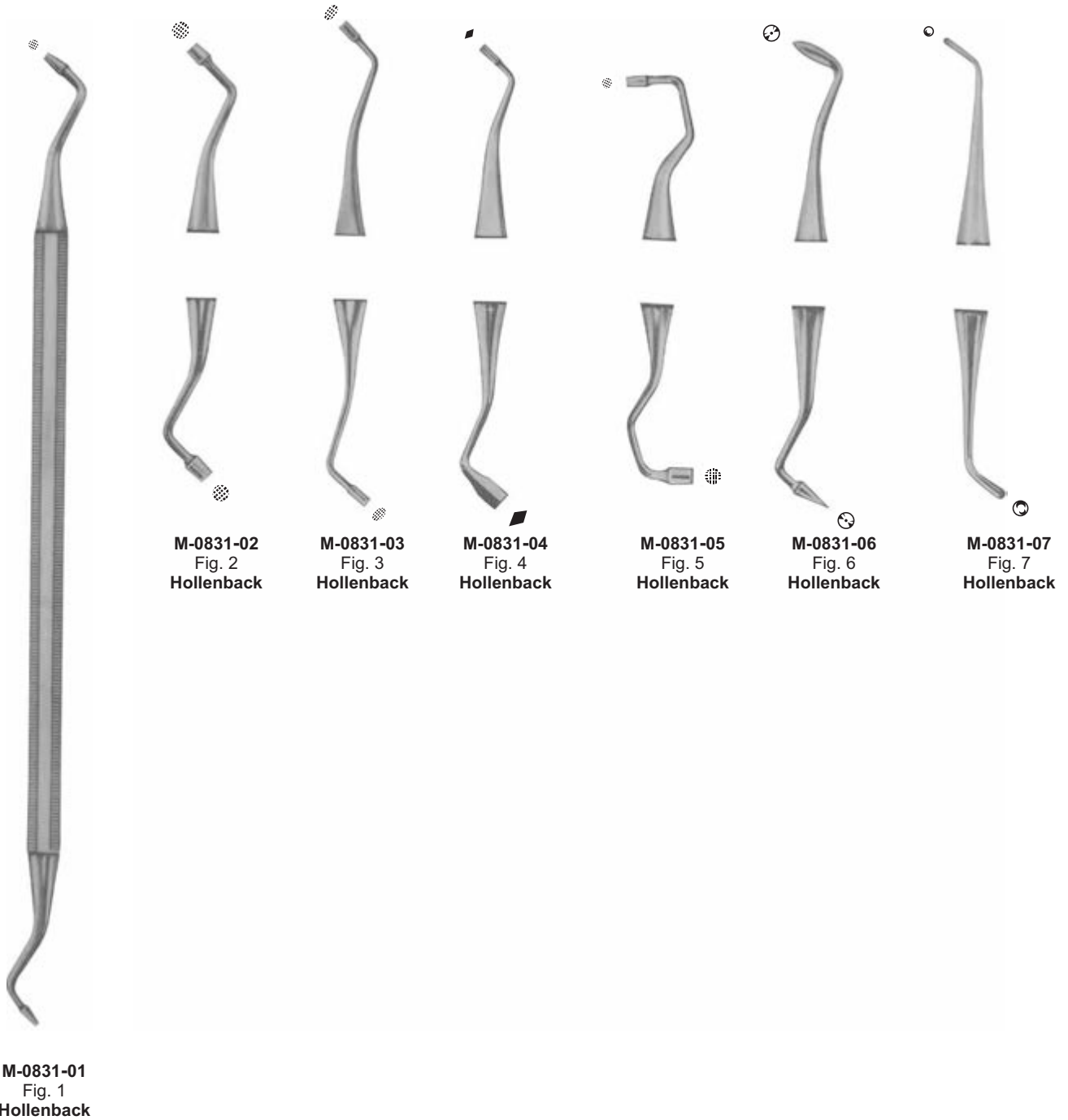

Amalgamstofer Amalgam Condensers

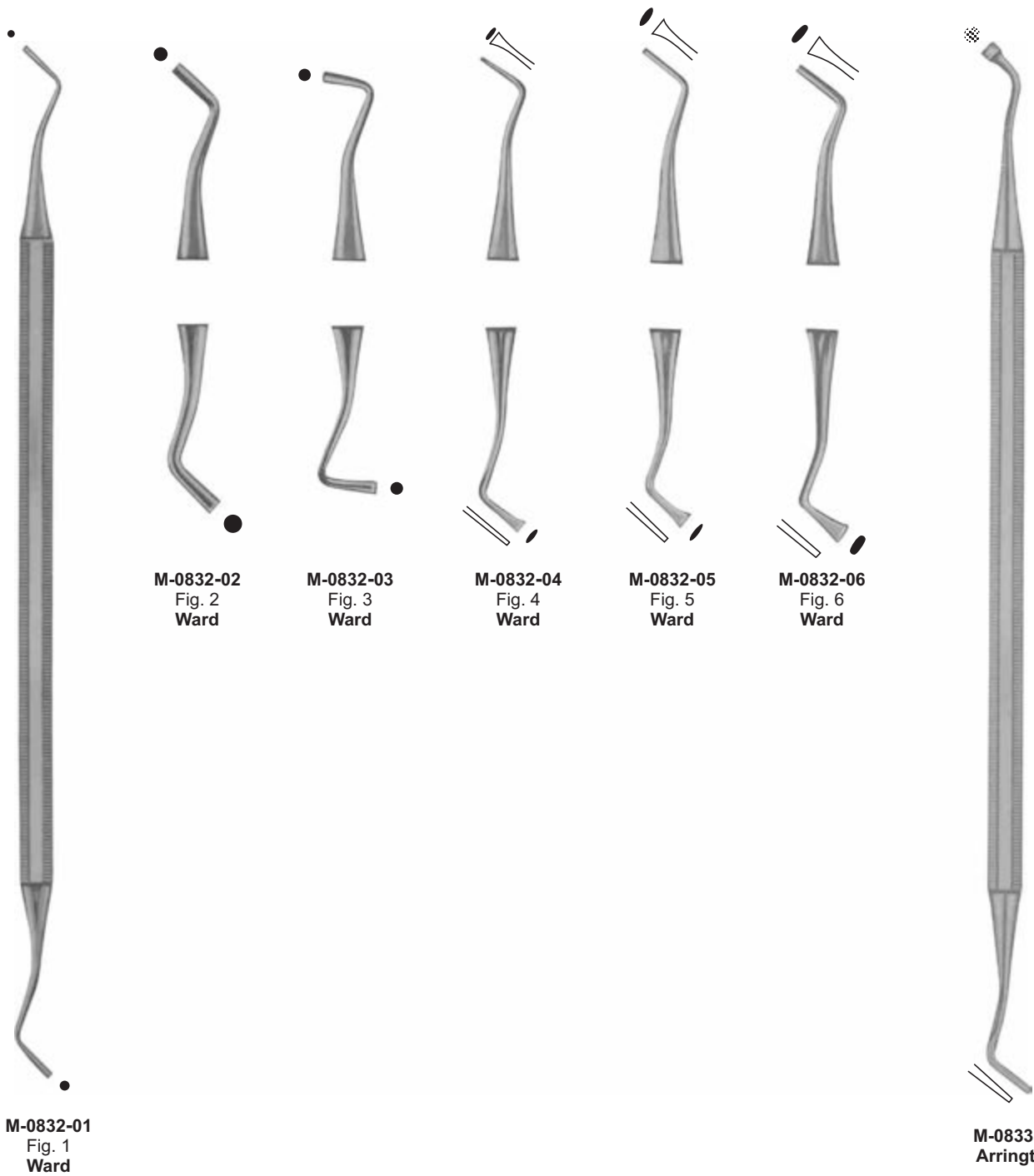

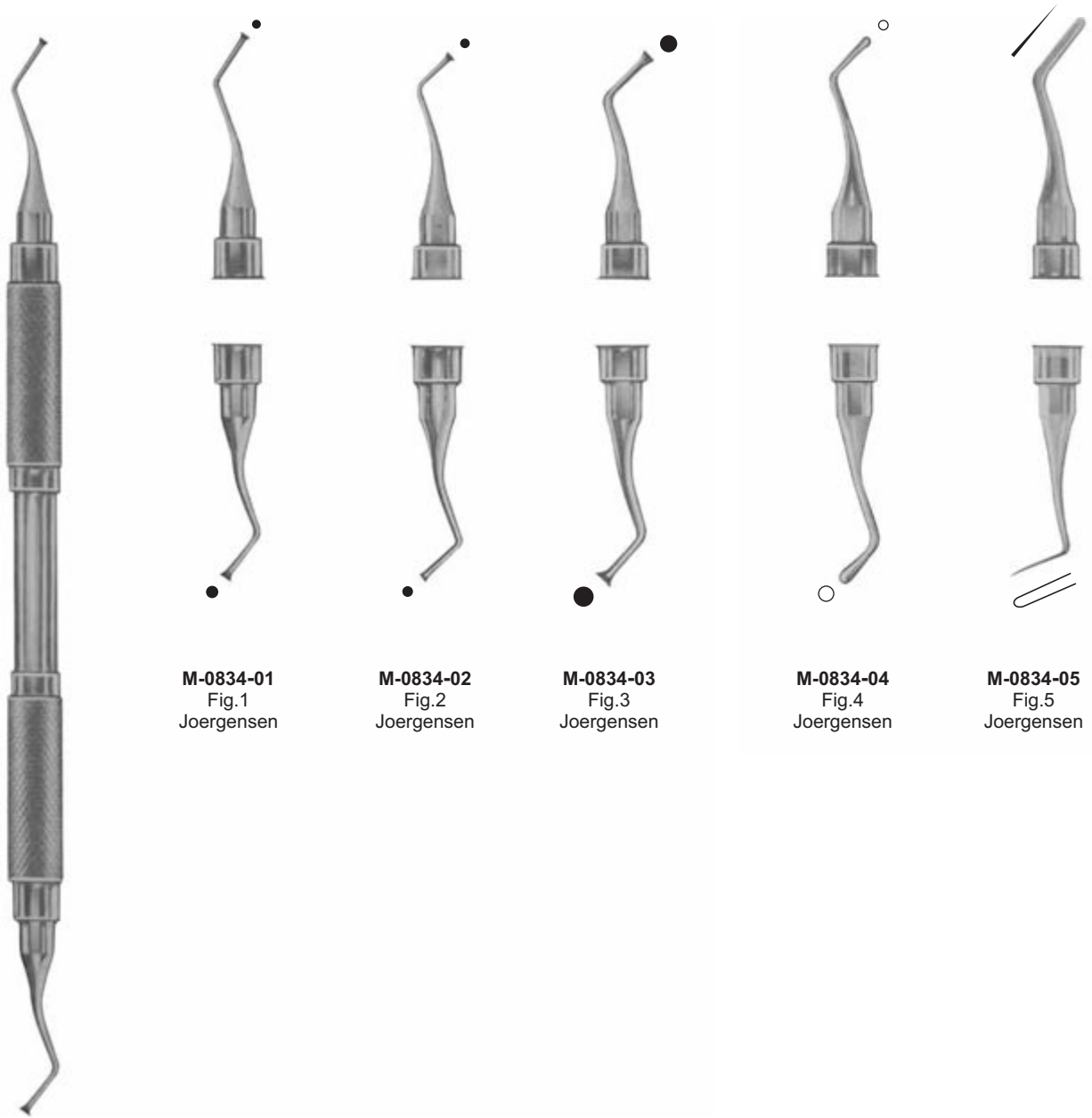

M-0834-01
Fig.1
Joergensen

M-0834-02
Fig.2
Joergensen

M-0834-03
Fig.3
Joergensen

M-0834-04
Fig.4
Joergensen

M-0834-05
Fig.5
Joergensen

Joergensen

Composite condenser with trumpet-shaped working ends is helpful for a dense application he removes easily and fast excess material.

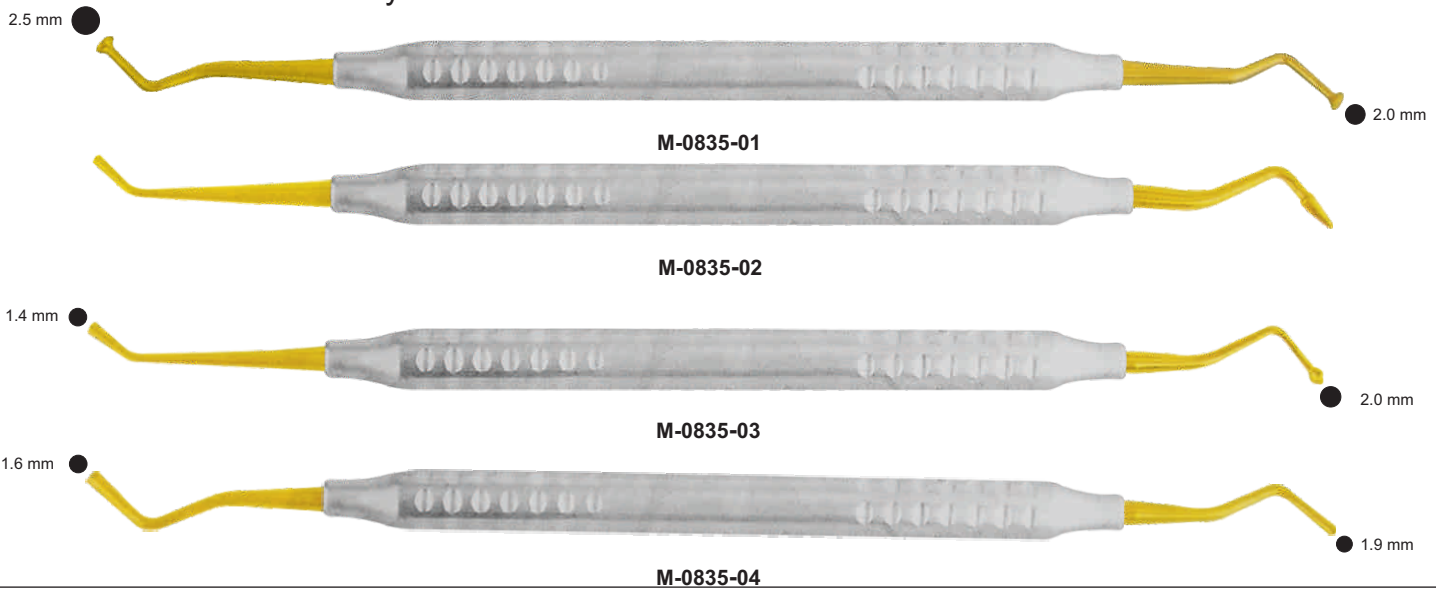

Composite condenser with flat working ends is helpful for a dense application in the cavity base

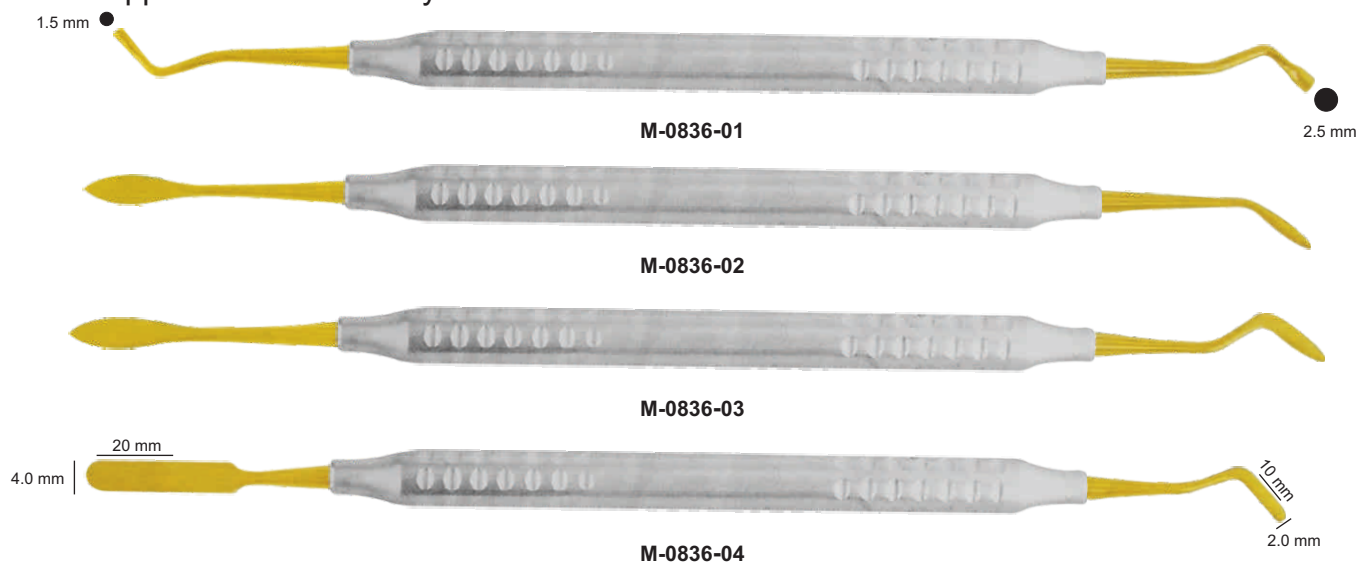

Pear-Shaped Composite condenser facilitates your work when condensing the composite Material inside the cavity.

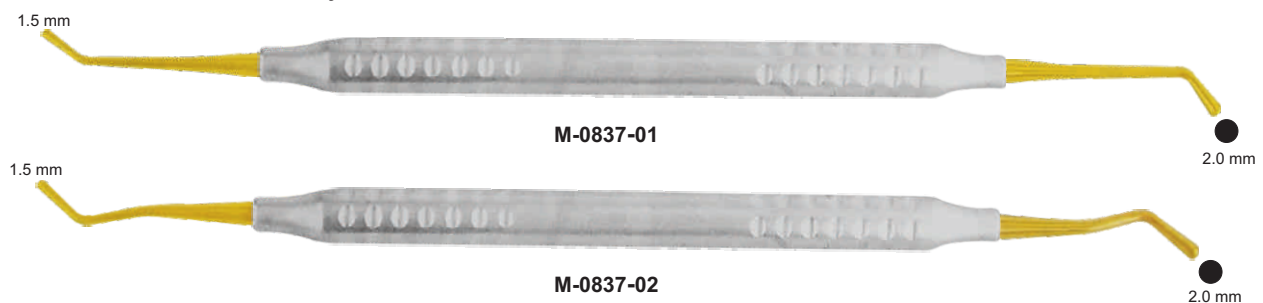

Composite condenser and modeling instruments with cone-shaped working ends for modelling and condensation. Especially on the cavity edges.



M-0838-01



M-0838-02



M-0838-03

composite instruments for exact moulding of the cusp



M-0839-01

The ball shaped Composite pluggers with contra angle provides an optimal condensation of the composite side the cavity.



M-0840-01



M-0840-02



M-0840-03

Composite pluggers ball pointed, for maximum condensation of the material



M-0841-01

**Instrumente zum modellieren von fullungen
Amalgam Carver**

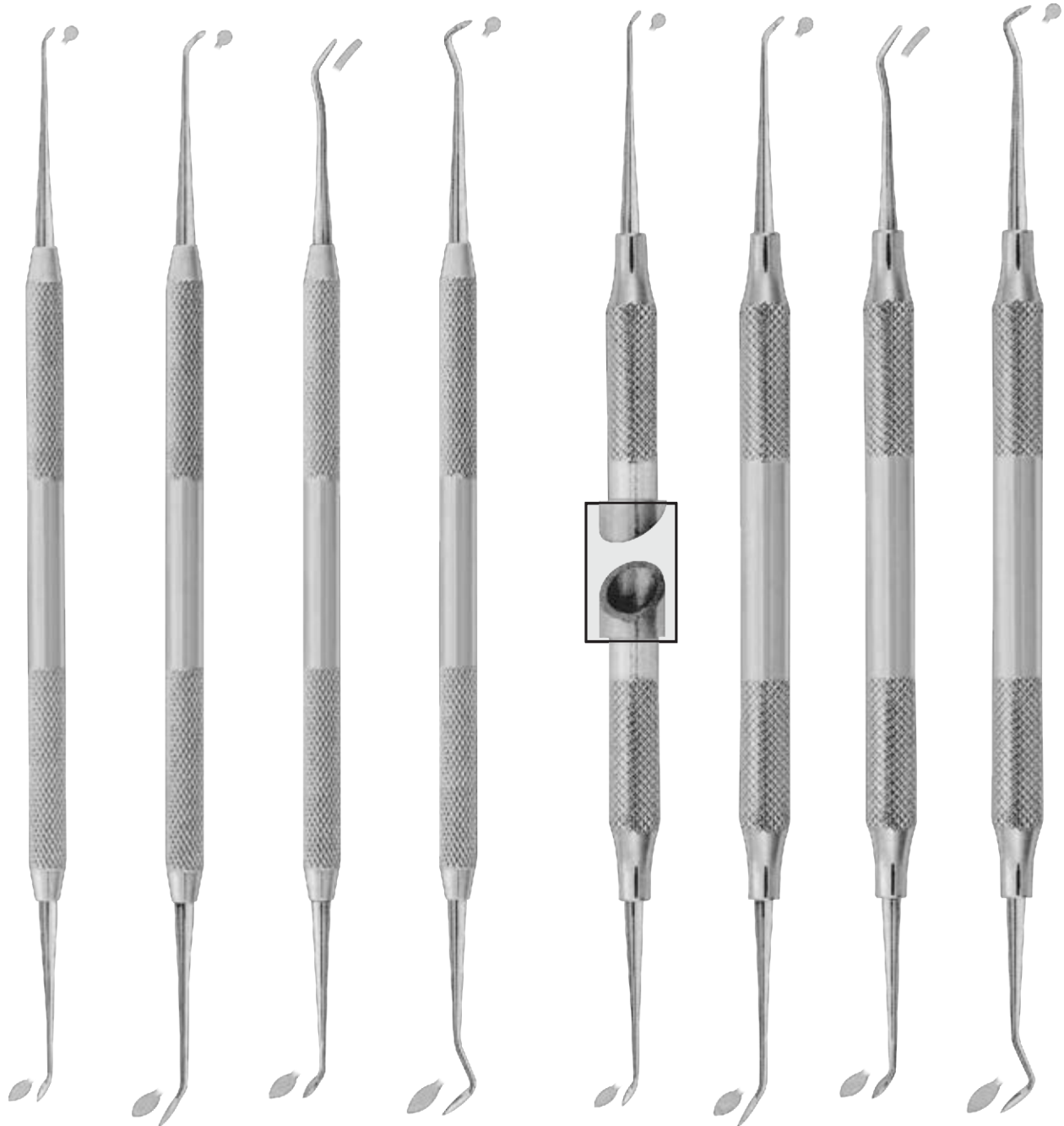

M-0842-01
Fig.1

M-0842-02
Fig.2

M-0842-03
Fig.3

M-0842-04
Fig.4

M-0842-01
Fig.1

M-0842-02
Fig.2

M-0842-03
Fig.3

M-0842-04
Fig.4

Cleoids-Discoids

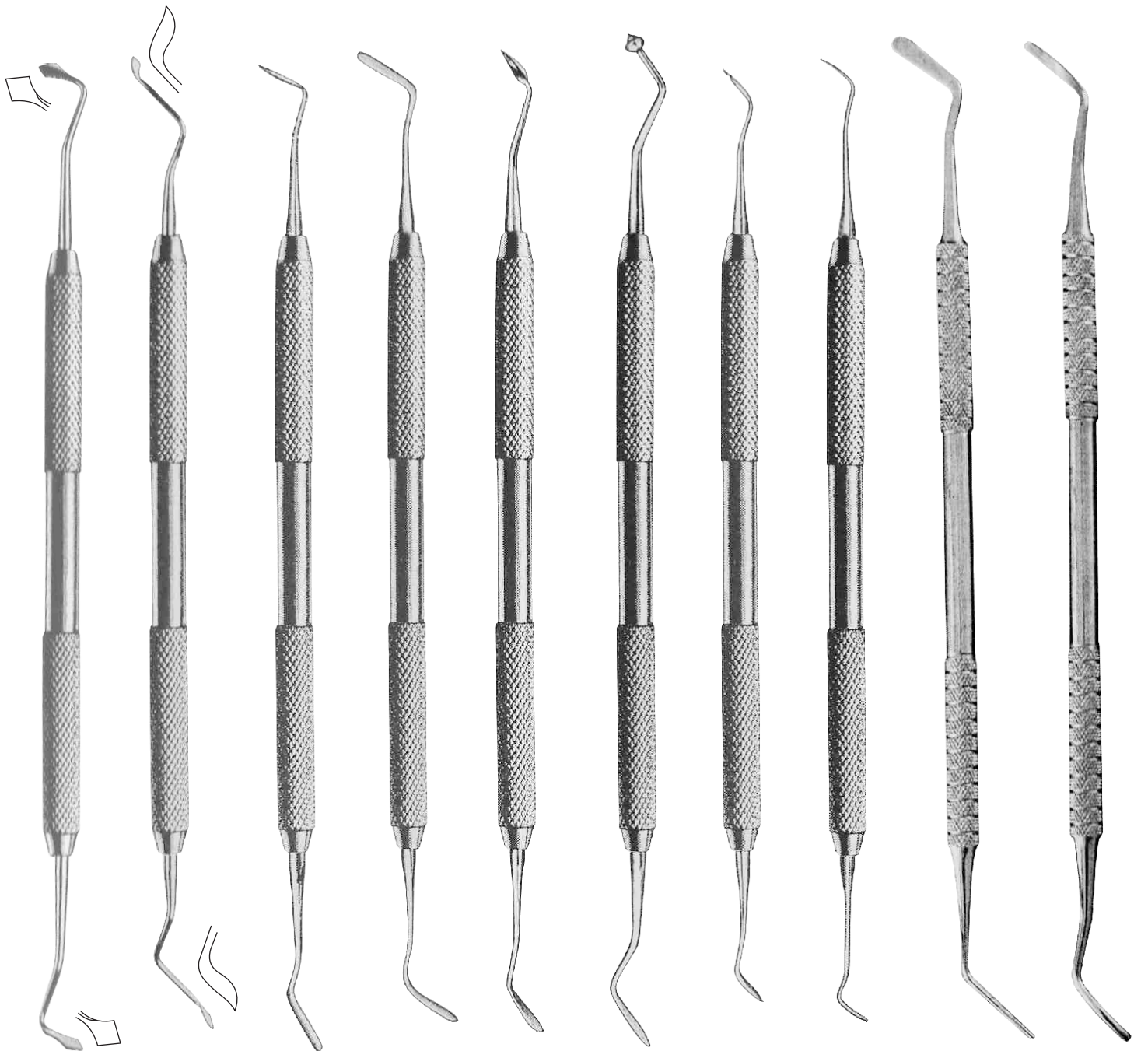

M-0843-01
Frahm

M-0844-02
USC

M-0845-01

M-0846-02

M-0847-00
SHO-A

M-0848-00
SHO-3

M-0849-00
104

M-0850-00
Wiland

M-0851-01
Glick

M-0851-02
Glick

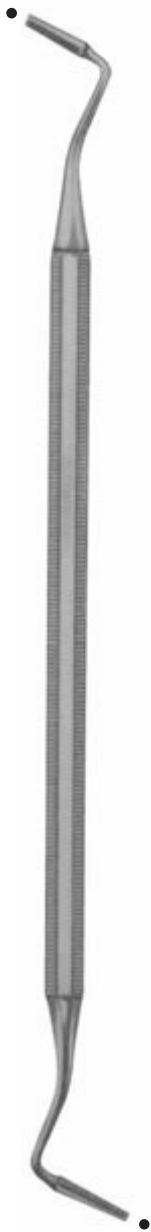

M-0852-01
Fig. 2
Mortonsen



M-0852-02
Fig. 21
Mortonsen



M-0852-03
Fig. 21B
Mortonsen



M-0853-01
Fig. 1



M-0853-02
Fig. 2



M-0853-03
Fig. 6



M-0853-04
Fig. 7



M-0853-05
Fig. 8



M-0853-06
Fig. 6A



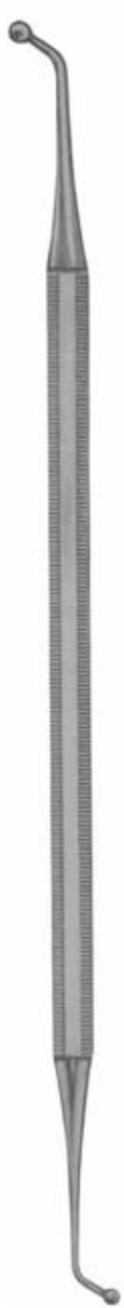

Wallis



M-0854-01
Fig.1
Wallis



M-0854-02
Fig.2
Wallis



M-0854-03
Fig.3
Wallis



M-0854-04
Fig.4
Wallis

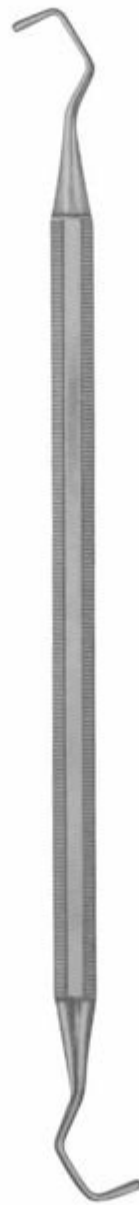

Ladmore



M-0855-01
Fig.1
Ladmore



M-0855-02
Fig.2
Ladmore



M-0855-03
Fig.3
Ladmore



M-0855-03
Fig.3
Ladmore



M-0855-03
Fig.3
Ladmore

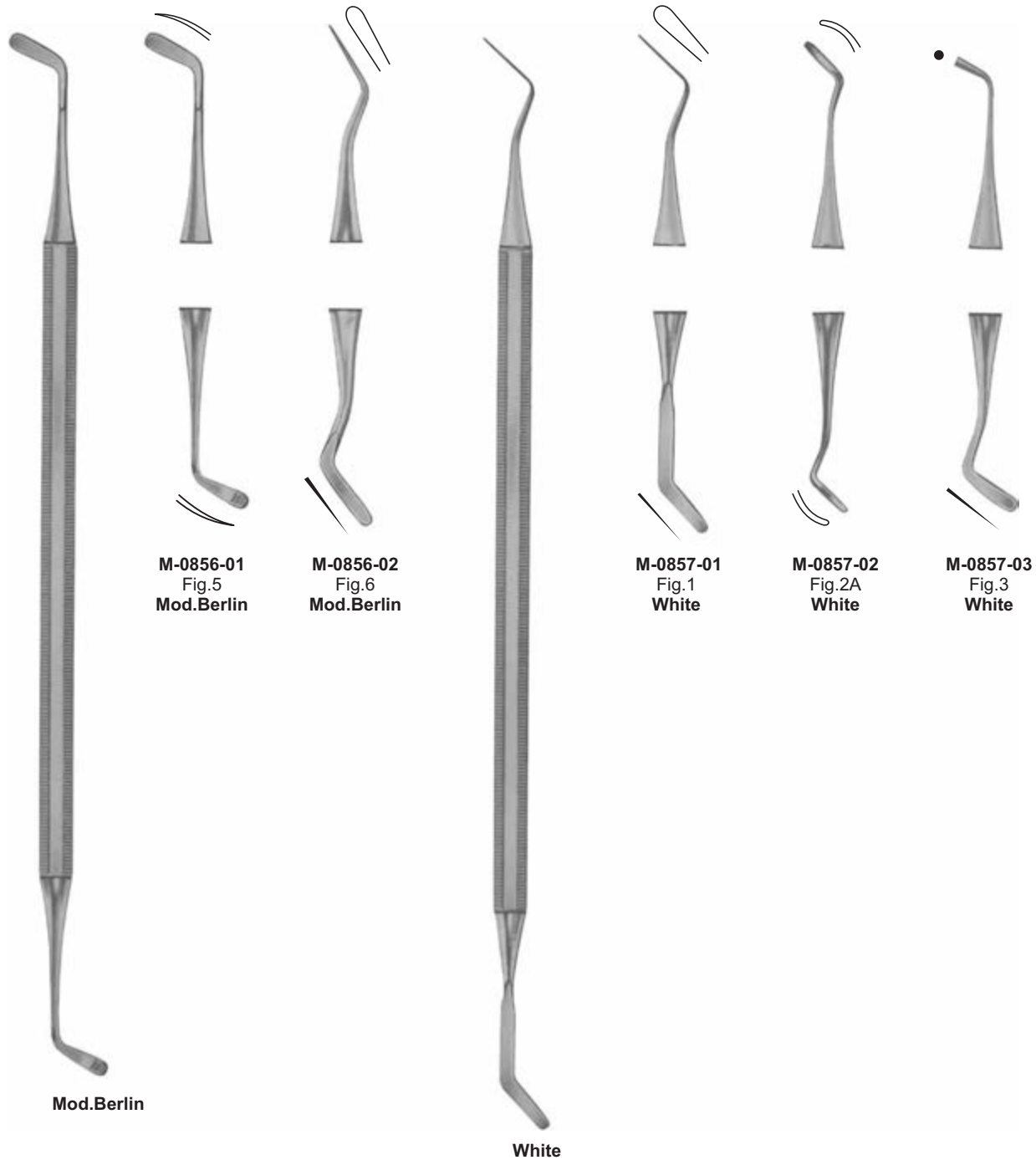

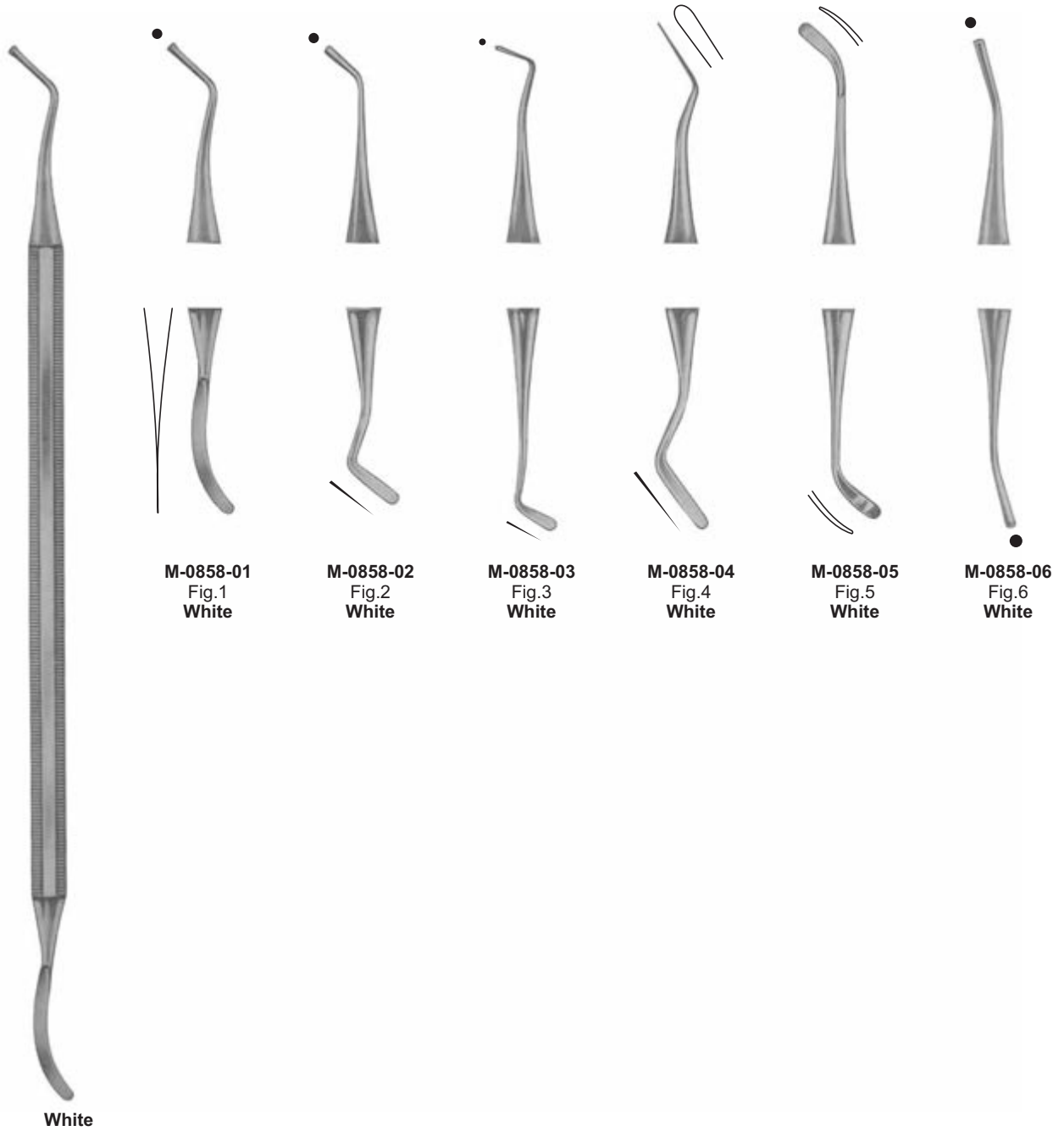



M-0859-01
Fig.1



M-0859-02
Fig.2



M-0859-03
Fig.3



M-0859-04
Fig.4



M-0860-02
Fig.2
Woodson



M-0859-05
Fig.5
Fig. 5



M-0859-06
Fig.6



M-0859-07
Fig.3A



M-0859-08
Fig.5A

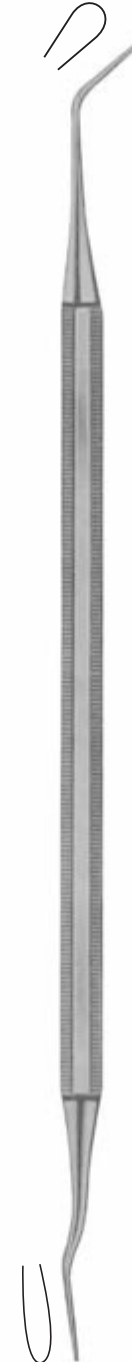

M-0860-01
Fig.1
Woodson



M-0860-03
Fig.3
Woodson



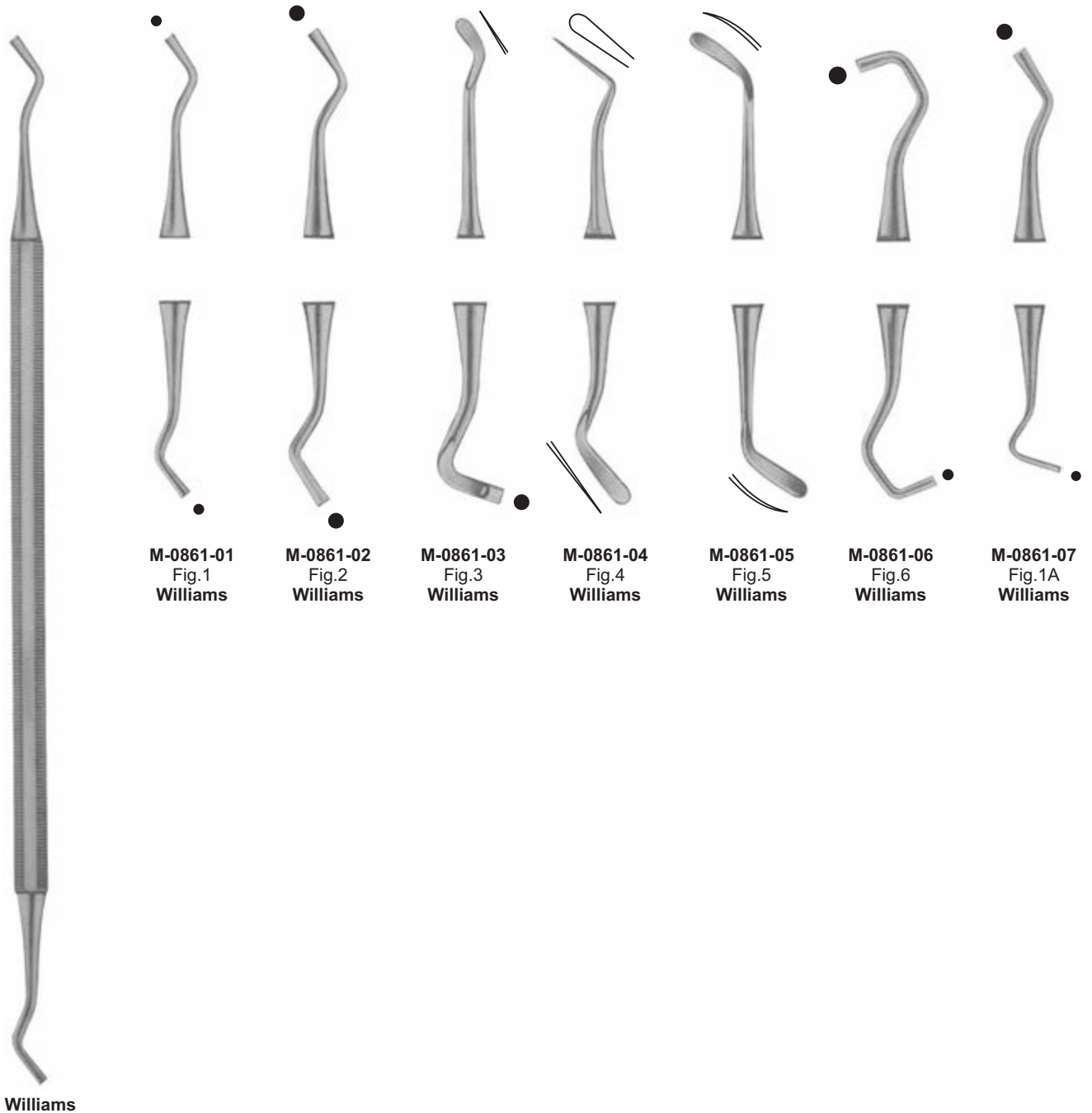

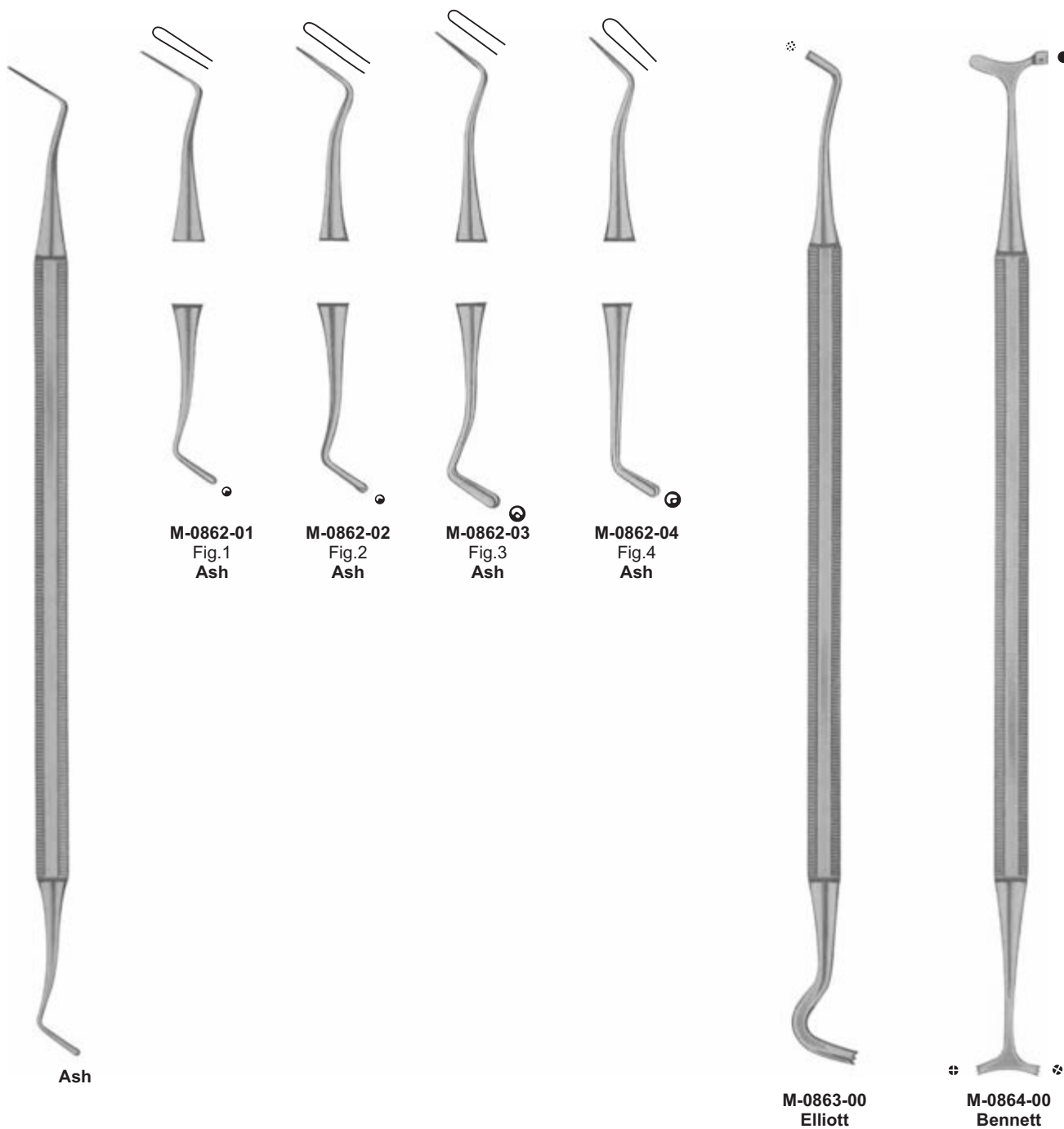

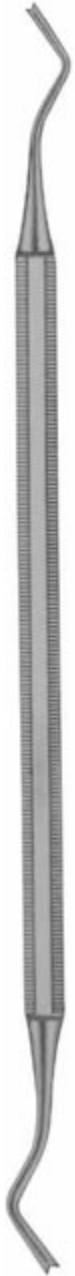

M-0865-01
Fig.1



M-0865-02
Fig.2



M-0865-04
Fig.4



M-0865-05
Fig.5



M-0865-06
Fig.6



M-0865-07
Fig.7



M-0865-08
Fig.8



M-0865-09
Fig.9





M-0866-01
Fig.10



M-0866-02
Fig.11



M-0866-03
Fig.12



M-0866-04
Fig.13



M-0866-05
Fig.14



M-0866-05
Fig.15



M-0866-06
Fig.16



M-0866-07
Fig.17





M-0867-01
Fig.28

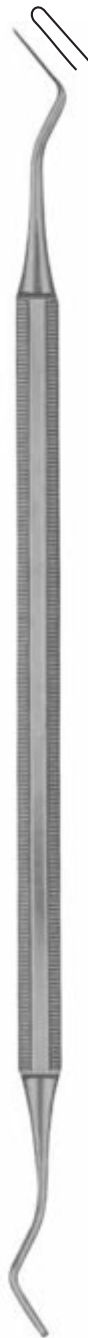

M-0867-02
Fig. 31

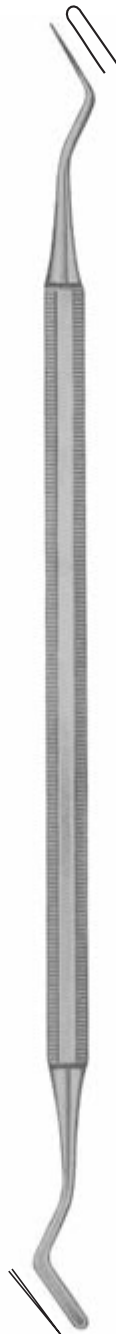

M-0867-03
Fig. 34

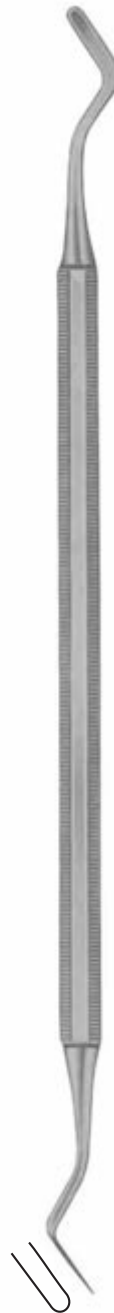

M-0867-04
Fig. 35

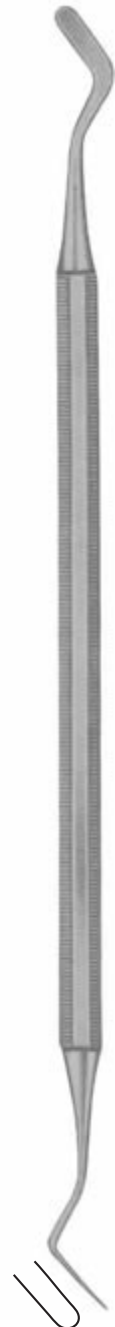

M-0867-05
Fig. 36

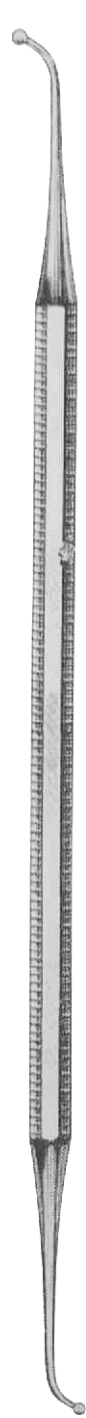

M-0871-01

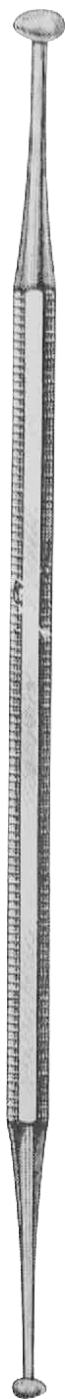

M-0872-00
Fig. 28/29



M-0873-00
Fig. 27/29

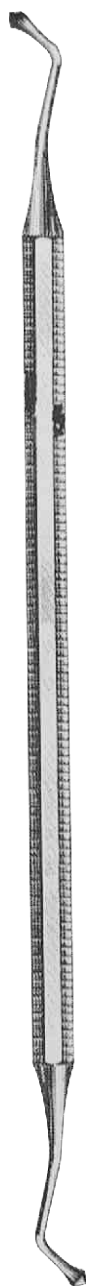

M-0874-01
Fig. 21B



M-0874-02
Fig. 21



M-0875-00
Fig. 89/92
Discoide



M-0876-00



M-0868-01
Fig. 1
Heidemann



M-0868-02
Fig. 2
Heidemann



M-0868-03
Fig. 3
Heidemann

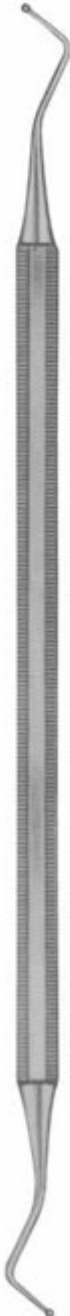

M-0869-01
Fig. 146



M-0869-03
Fig. 148



M-0869-02
Fig. 147



M-0869-04
Fig. 149

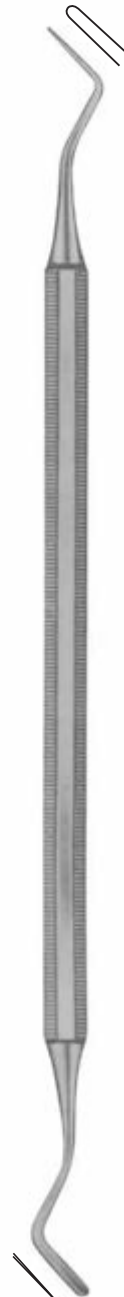

M-0870-01
Fig. 158

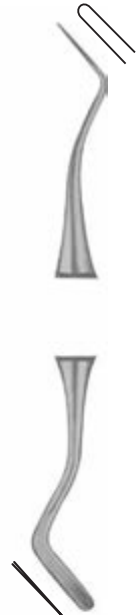

M-0870-02
Fig. 159

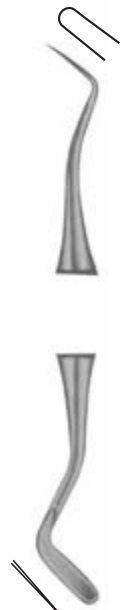

M-0870-03
Fig. 160



M-0877-00
89/90
Cleoid-Discoid



M-0878-17
17
Excavator



M-0879-00



M-0880-00



M-0881-00
Amalgam condenser



White



**M-0882-01
Fig. 28
White**



**M-0882-02
Fig. 29
White**



**M-0882-03
Fig. 30
White**



**M-0882-04
Fig. 32
White**



**M-0882-05
Fig. 33
White**



**M-0882-06
Fig. 34
White**



M-0883-01
Roach

M-0884-01
Vehe

M-0885-01
Beale

M-0886-01
Le Cron

M-0886-02
Le Cron

M-0886-03
Le Cron

M-0886-04
Le Cron

M-0887-01
Gritman

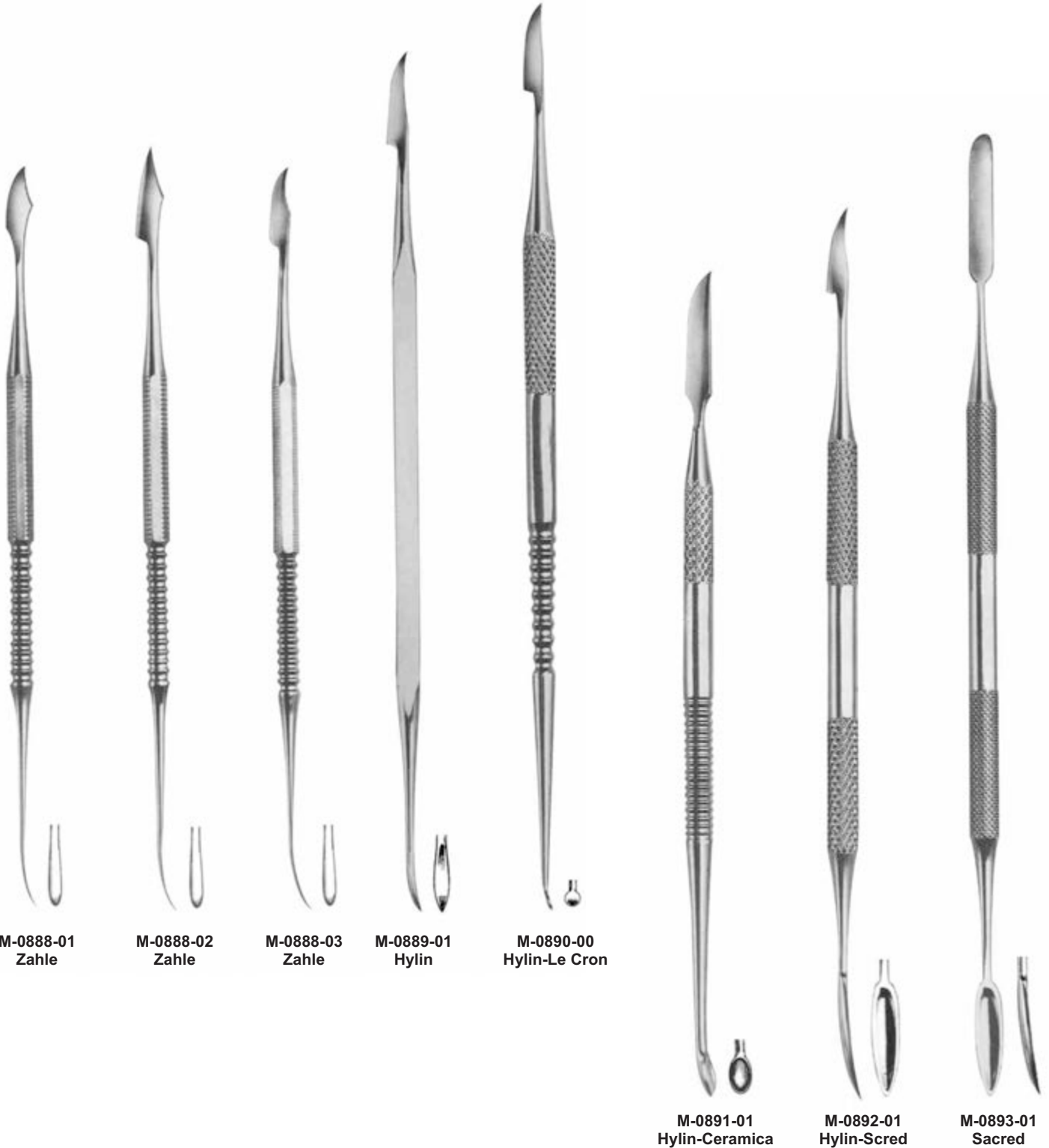

M-0888-01
Zahle

M-0888-02
Zahle

M-0888-03
Zahle

M-0889-01
Hylin

M-0890-00
Hylin-Le Cron

M-0891-01
Hylin-Ceramica

M-0892-01
Hylin-Scred

M-0893-01
Sacred

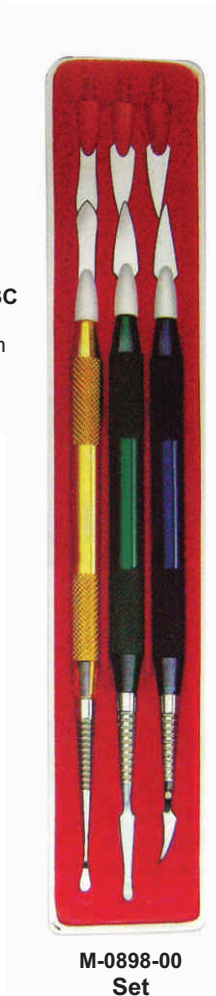
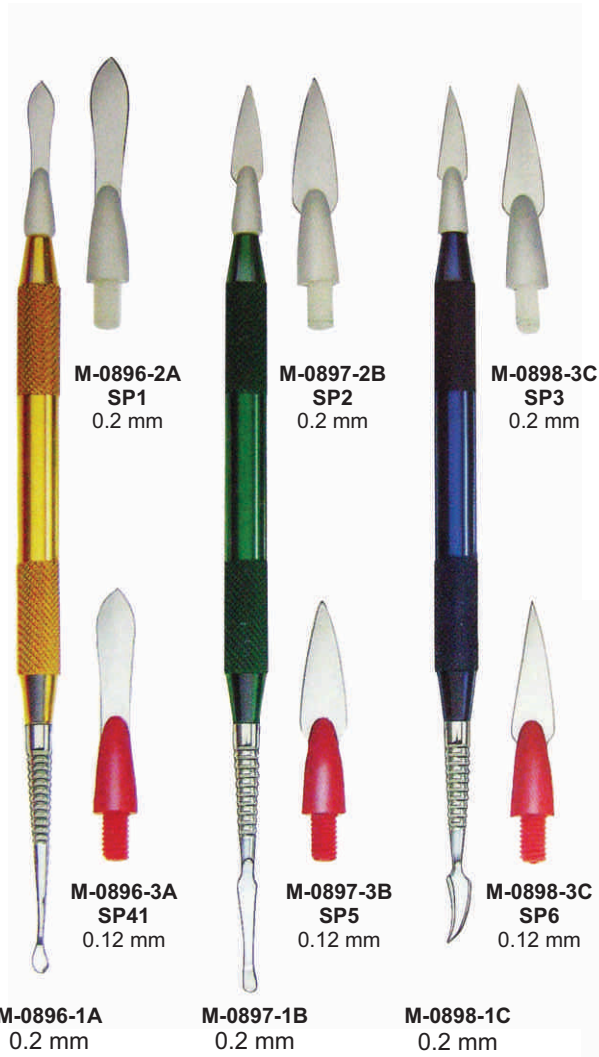



M-0894-01
Fig. 1
0.9 mm



M-0894-02
Fig. 2



M-0894-03
Fig. 3



M-0894-04
Fig. 4



M-0894-05
Fig. 5



M-0894-00
1-5 set
Fig. 1,2,3,4,5



M-0895-01
Le Cron



M-0895-02
Le Cron

APPLICATORI PER SOTTOFONDO



M-0900-00



M-0900-01
Fig. 1



M-0900-02
Fig. 2



M-0901-01
PK Thomas
Fig. 1



M-0901-02
PK Thomas
Fig. 2



M-0901-03
PK Thomas
Fig. 3



M-0901-04
PK Thomas
Fig. 4



M-0901-05
PK Thomas
Fig. 5

In Silver Handle Different Colors



M-0902-01
PK Thomas
Fig. 1



M-0902-02
PK Thomas
Fig. 2



M-0902-03
PK Thomas
Fig. 3



M-0902-04
PK Thomas
Fig. 4



M-0902-05
PK Thomas
Fig. 5



M-0904-01



M-0904-02



M-0904-03



M-0904-04



M-0904-05



M-0904-06



M-0904-07



M-0904-08



M-0904-09



M-0904-10



M-0904-11



M-0905-01
Fig. 1



M-0905-02
Fig. 2



M-0905-03
Fig. 3

Double-ended composite micro spatula
for the finishing work of the cavity

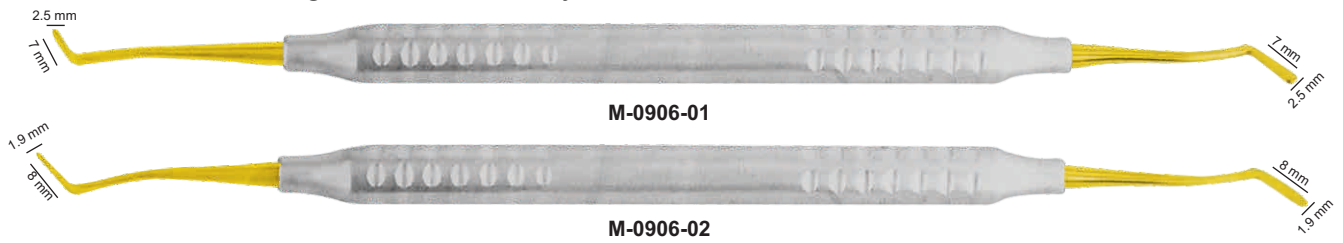

Double-ended composite micro spatula for various applications. The flexible working ends are aligned opposite and enable an easier preparation with composite material when applying into the cavity by giving a better view into the operating area.

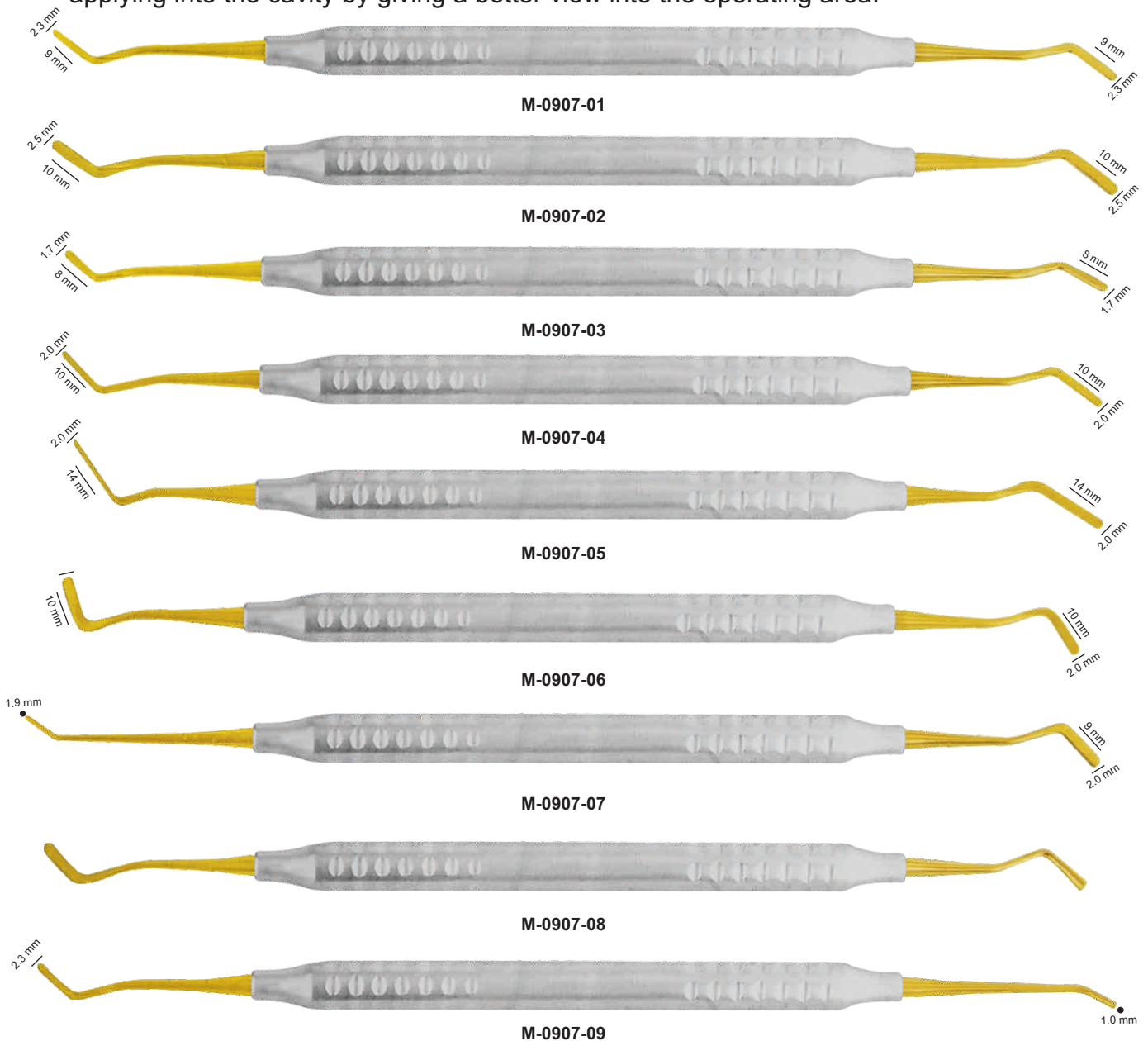

GRACEY CURETTES

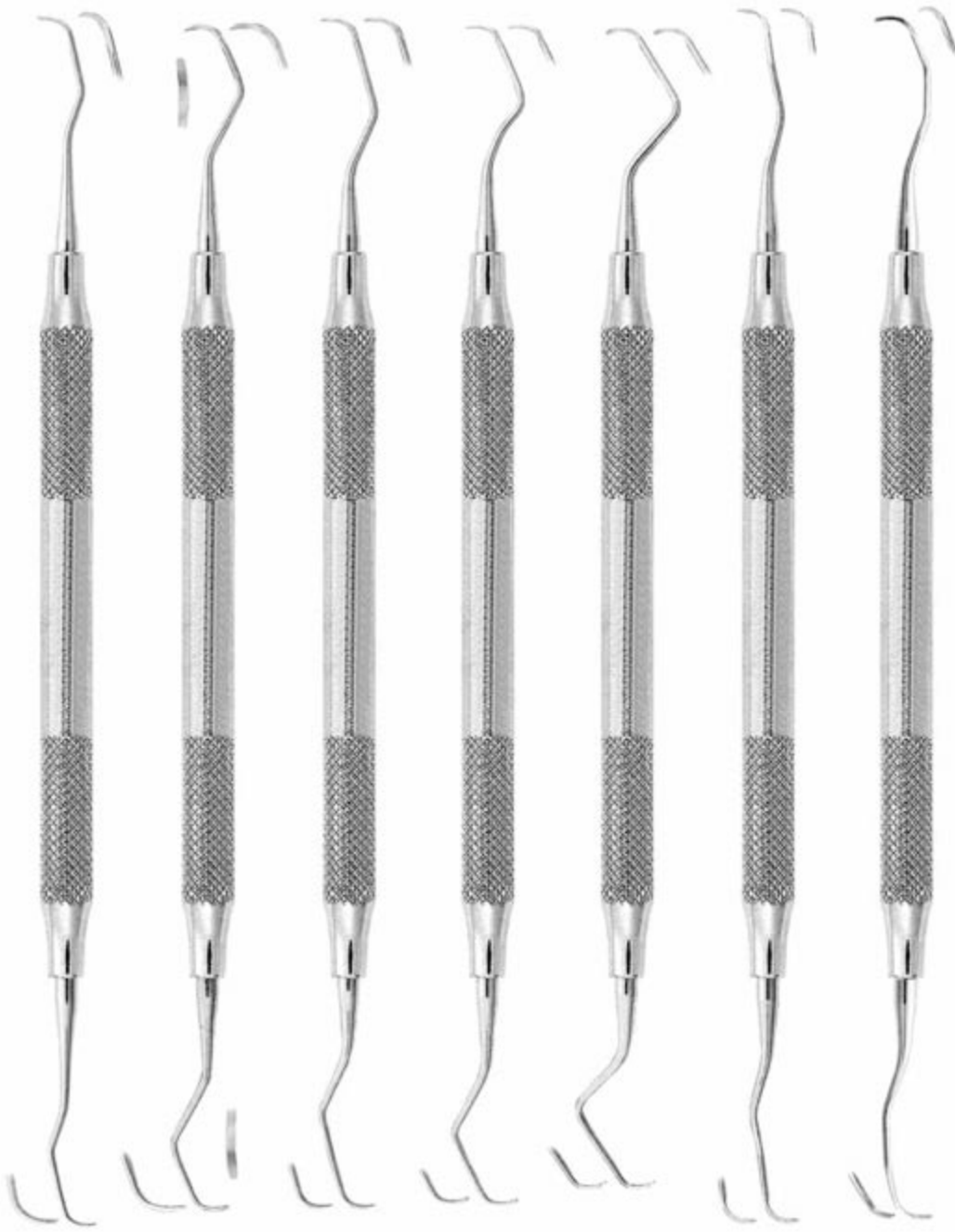

M-0908-01
Fig. 1/2

M-0908-02
Fig. 3/4

M-0908-03
Fig. 5/6

M-0908-04
Fig. 7/8

M-0908-05
Fig. 9/10

M-0908-06
Fig. 11/12

M-0908-07
Fig. 13/14



M-0908-08
Fig. 15/16

M-0908-09
Fig. 17/18

GRACEY CURETTES



M-0910-01
Fig. 1/2



M-0910-02
Fig. 3/4



M-0910-03
Fig. 5/6



M-0910-04
Fig. 7/8



M-0910-05
Fig. 9/10



M-0910-06
Fig. 11/12



M-0910-07
Fig. 13/14

GRACEY CURETTES



M-0909-01
Fig. 1/2



M-0909-02
Fig. 3/4

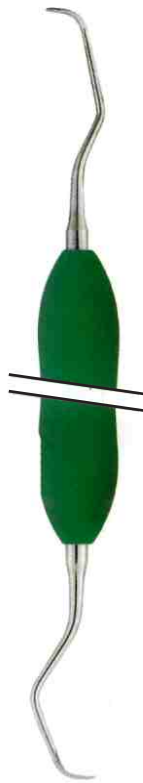

M-0909-03
Fig. 5/6

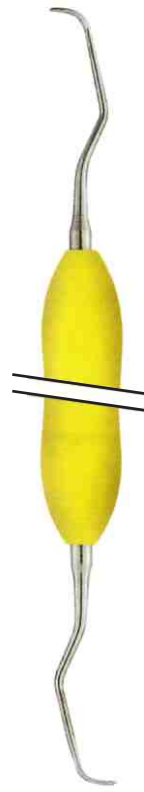

M-0909-04
Fig. 7/8



M-0909-05
Fig. 9/10



M-0909-06
Fig. 11/12

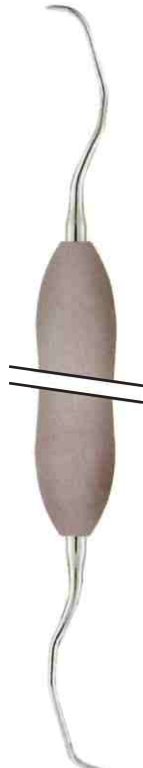

M-0909-07
Fig. 13/14

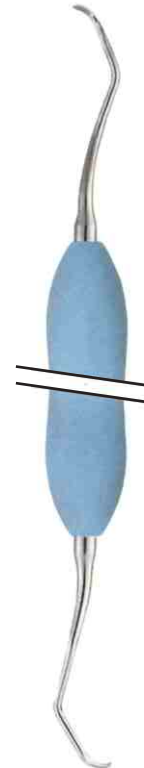

M-0909-08
Fig. 15/16



M-0909-09
Fig. 17/18

Parodontal-Kuretten
Periodontal Curettes



M-0912-01
Fig. 7/8



M-0912-02
Fig. 9/10



M-0912-03
Fig. 11/12



M-0912-04
Fig. 13/14



M-0912-05
Fig. 15/16

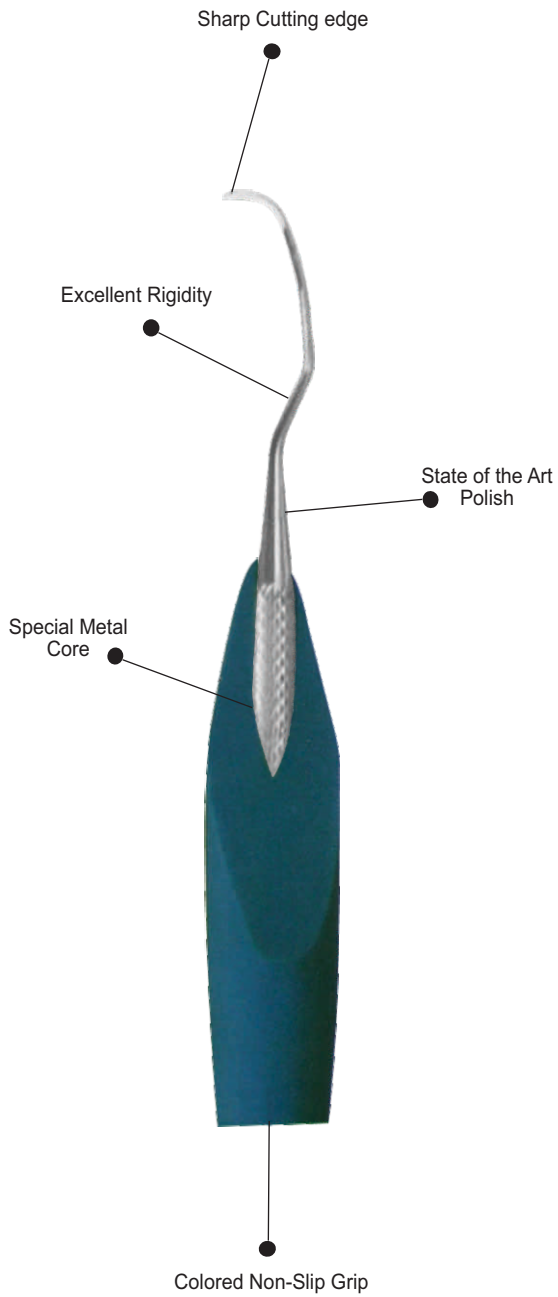

Overall light weight structure

MAX GRIP Instruments can be sterilized / Autoclaved upto 200 C
All other type of periodontal curettes & hand instruments including explorers, filling instruments etc, are available in **MAX GRIP** handle



M-0911-01
Fig. 1/2



M-0911-02
Fig. 3/4



M-0911-03
Fig. 5/6

Parodontal-Kuretten
Periodontal Curettes

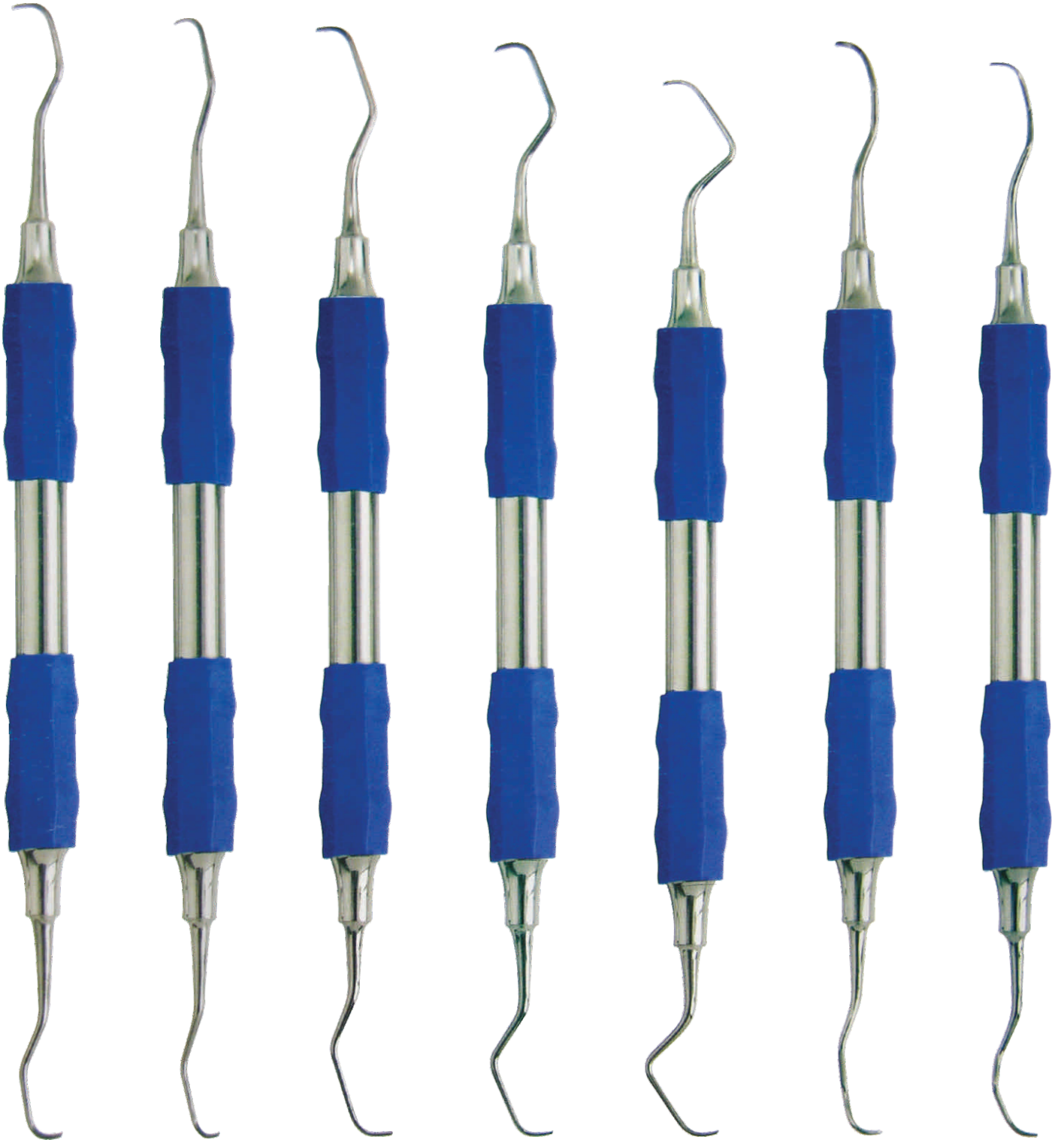

M-0913-01
Fig. 1/2
Gracey

M-0913-02
Fig. 3/4
Gracey

M-0913-03
Fig. 5/6
Gracey

M-0913-04
Fig. 7/8
Gracey

M-0913-05
Fig. 9/10
Gracey

M-0913-06
Fig. 11/12
Gracey

M-0913-07
Fig. 13/14
Gracey

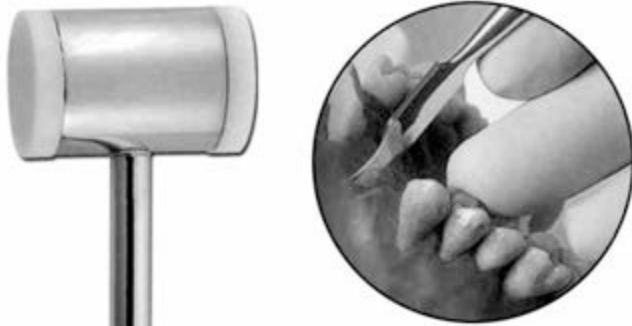

M-0914-09
Mead
19,5 cm



M-0915-14
Partsch
14,5 cm

M-0916-01
Willinger
16 cm

M-0916-02
Willinger
16 cm



M-0917-01
Gardner



M-0917-02
Gardner



M-0918-00
Buckley



M-0919-00
Miller



M-0920-01
Ochsenein
Fig. 1

M-0920-02
Ochsenein
Fig. 2



M-0921-00
Freer



M-0922-00
Goldman Fox
Fig. GF



M-0923-00
Molt
Fig. M9



M-0924-01
Prichard
Fig. Pr3



M-0924-02
Prichard



M-0925-01
Ppbuser



4,0 / 5,0 mm

M-0925-02
Ppbuser

Gingivectomy Knives



**M-0926-01
Goldman Fox
Fig. 7**

**M-0926-02
Goldman Fox
Fig. 8**

**M-0926-03
Goldman Fox
Fig. 9**

**M-0927-03
Buck
Fig. 3/4**

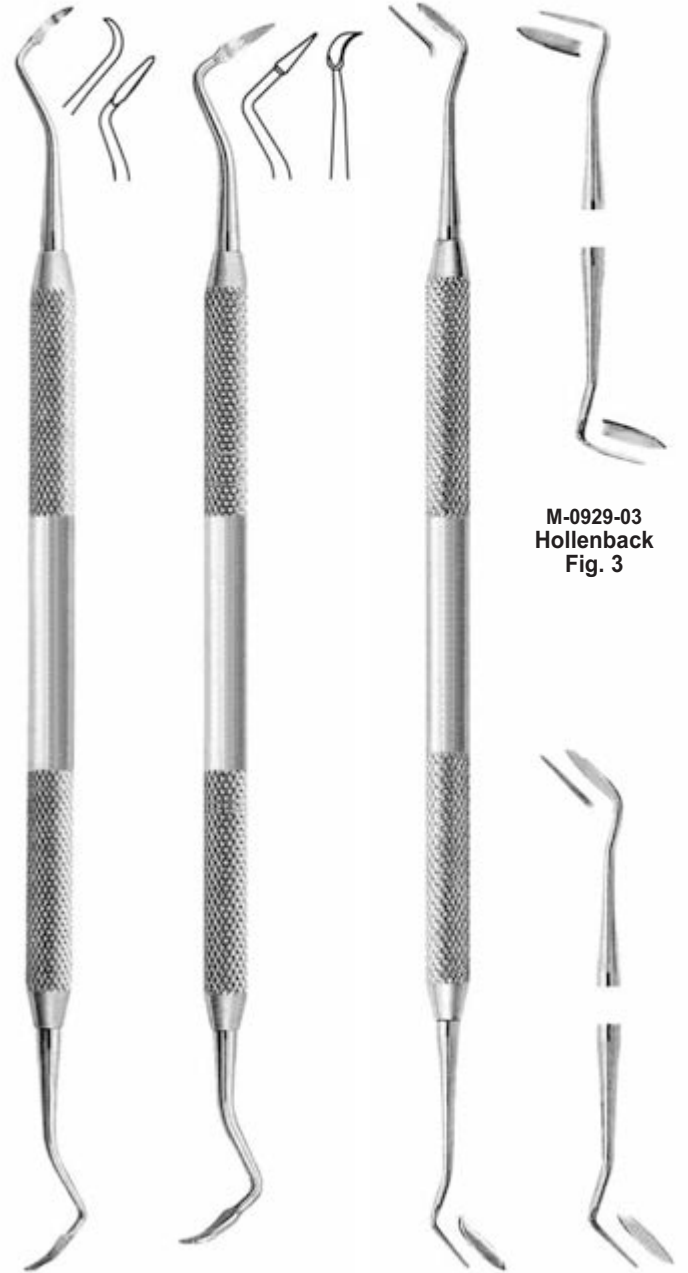

**M-0928-01
Taylor
Fig. 1**

**M-0928-02
Taylor
Fig. 2**

**M-0929-01
Hollenback
Fig. 1/ 2**

**M-0929-02
Hollenback
Fig. 3S**

**M-0929-03
Hollenback
Fig. 3**

Gingivectomy Knives

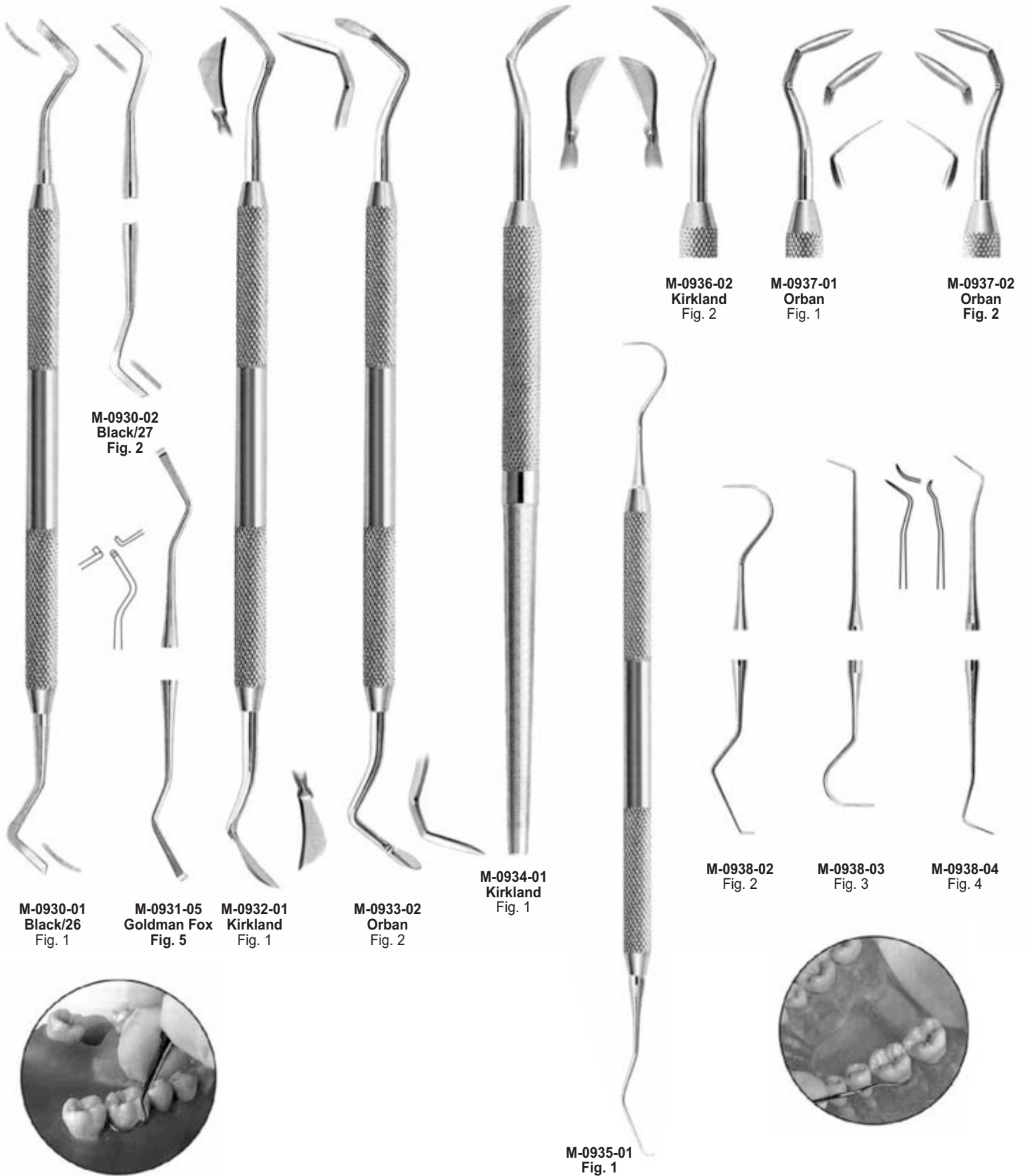

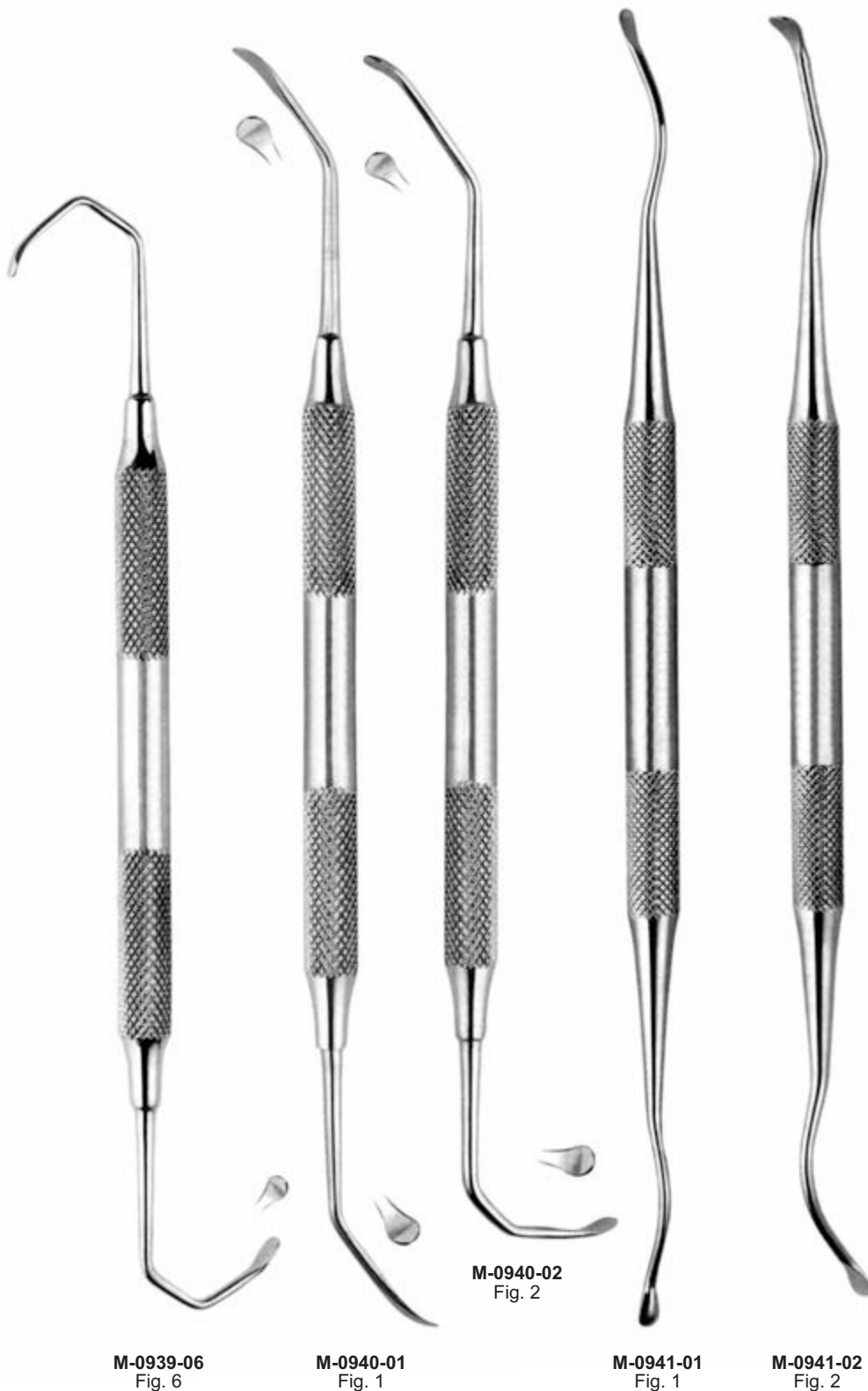

**TREPINE BURS
FRESE CAROTATRICI TREPINE
PUNTE MILLIMETRATE**

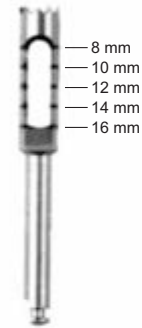
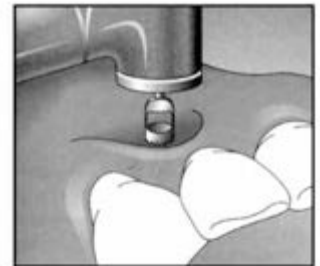

M-0942-01
Ø mm. 3 est
Ø mm. 2,5 int.



M-0942-02
Ø mm. 5 est
Ø mm. 4,5 int.



M-0942-03
Ø mm. 7 est
Ø mm. 6,5 int.



M-0942-04
Ø mm. 10 est
Ø mm. 9,5 int.

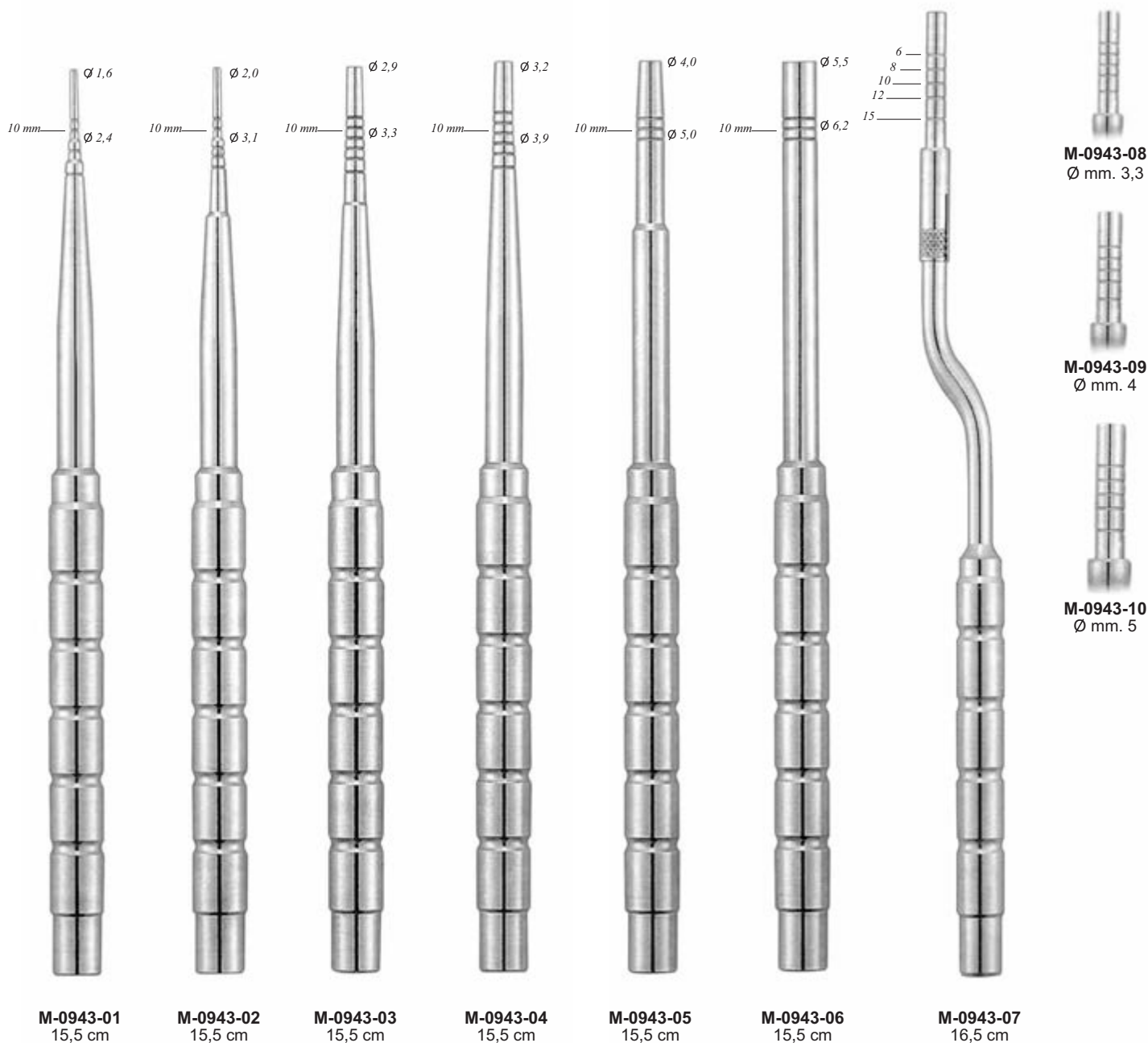



SEGITECH

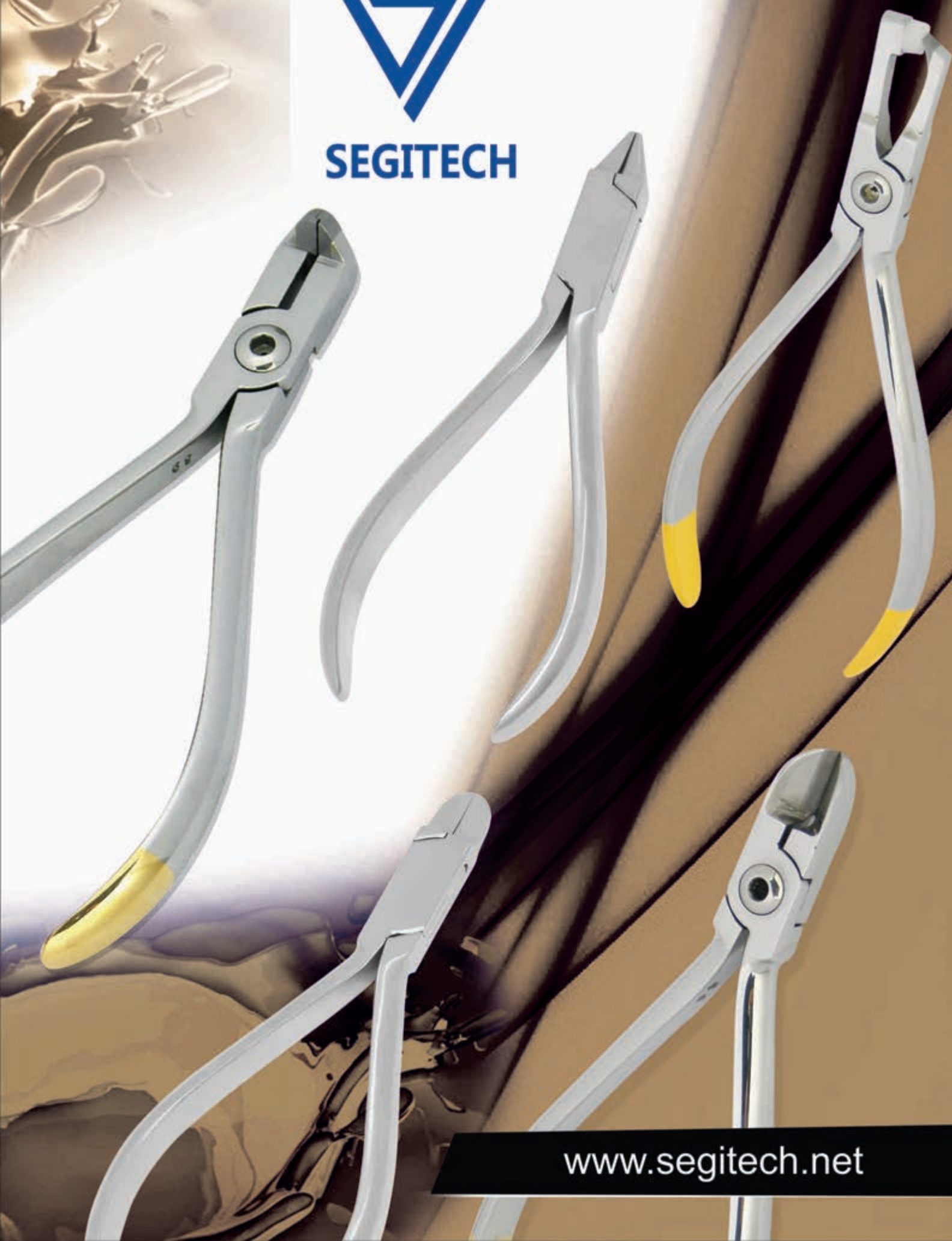

www.segitech.net

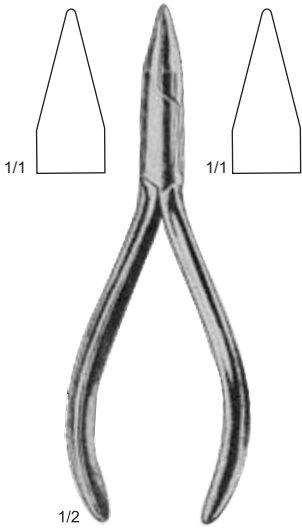

M-0950-13
13.5 cm

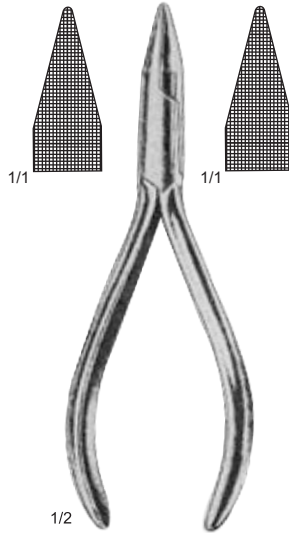

M-0951-13
13.5 cm
Flat Nose Plier

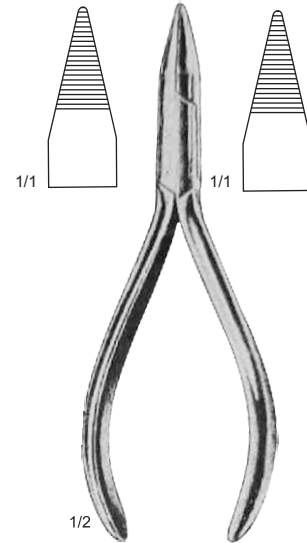

M-0952-13
13.5 cm

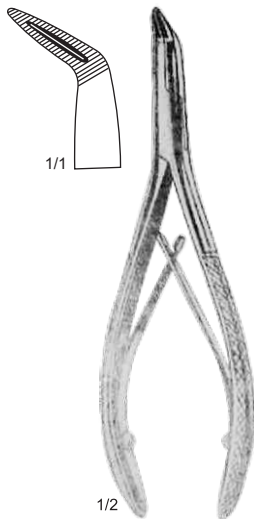

M-0953-13
13.5 cm
Stieglitz

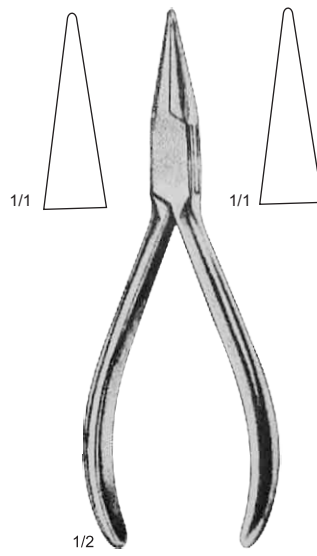

M-0954-14
14 cm

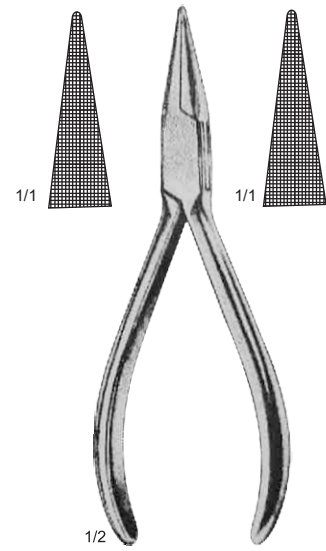

M-0955-14
14 cm

Zahntechnische Zangen
Orthodontic Pliers

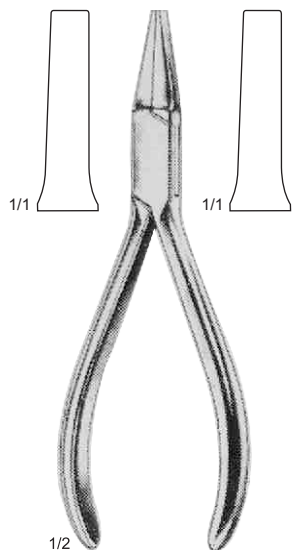

M-0956-14
14 cm

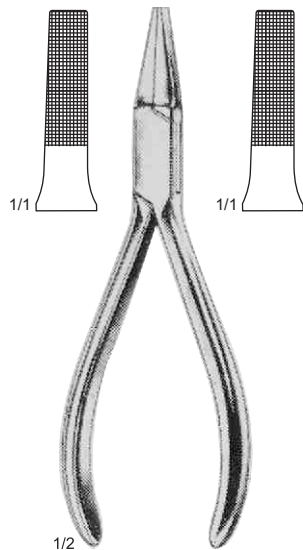

M-0957-14
14 cm

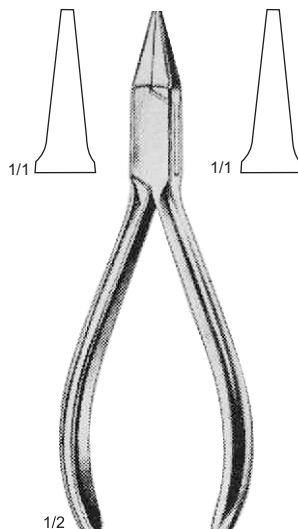

M-0958-13
13.5 cm

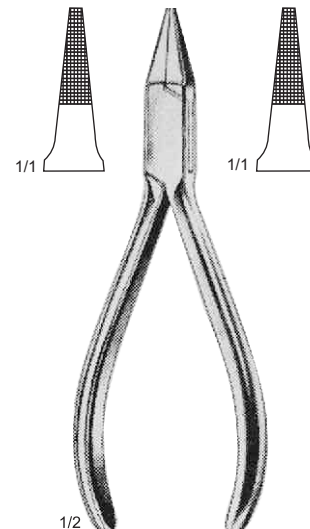

M-0959-13
13 cm

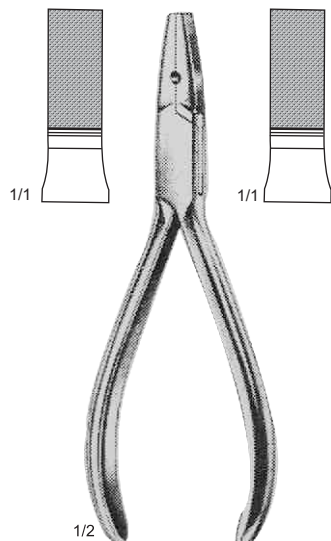

M-0960-14
14 cm

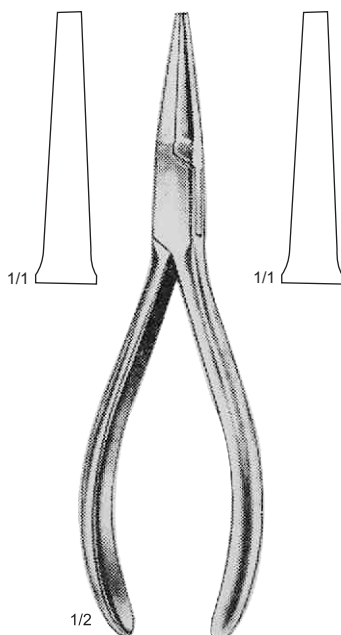

M-0961-16
16 cm

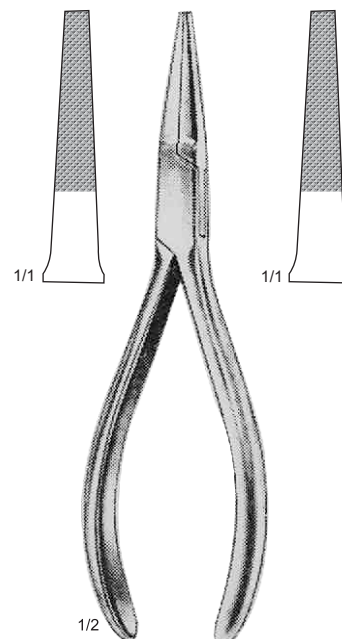

M-0962-16
16 cm

Langbeck

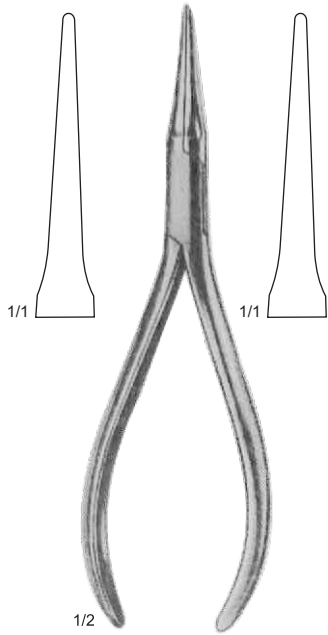

M-0963-16
16.5 cm

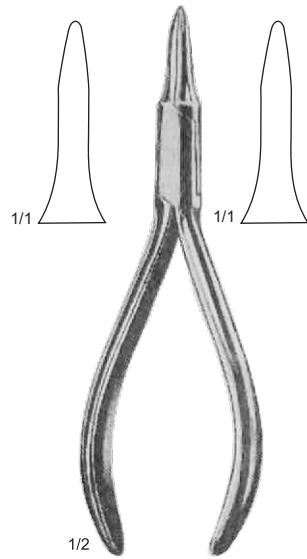

M-0964-14
14 cm

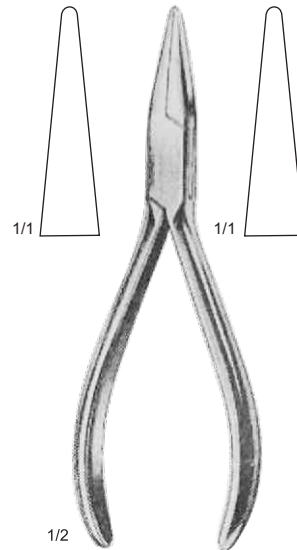

M-0965-14
14 cm

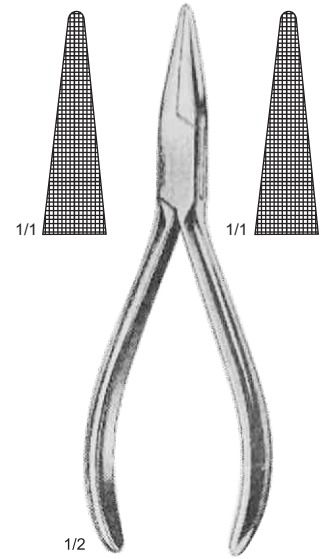

M-0966-14
14 cm

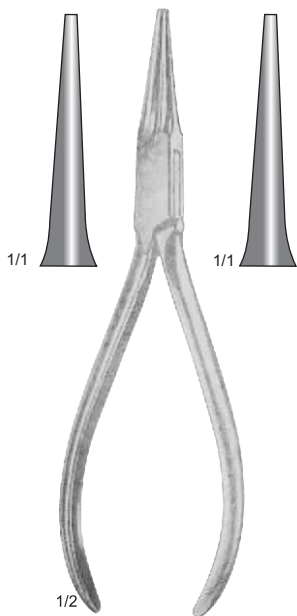

M-0967-15
15.5 cm

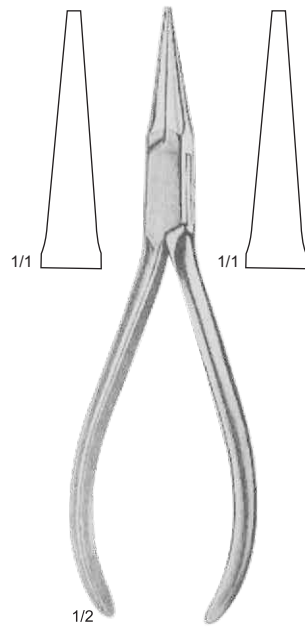

M-0968-15
15.5 cm

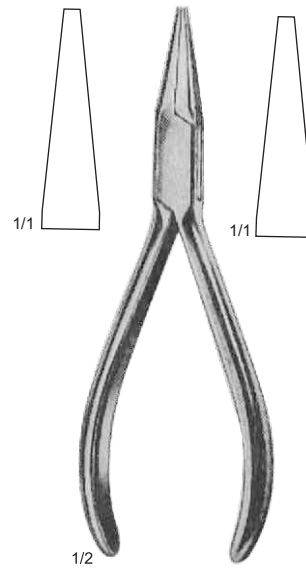

M-0969-14
14 cm

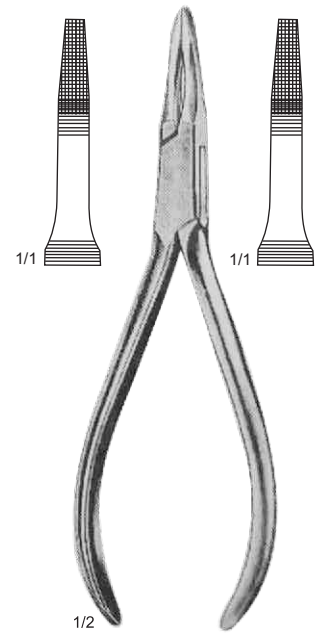

M-0970-15
15.5 cm
Fischer

Zahntechnische Zangen Orthodontic Pliers

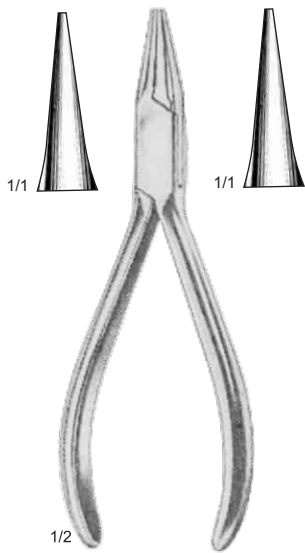

M-0971-14
14 cm

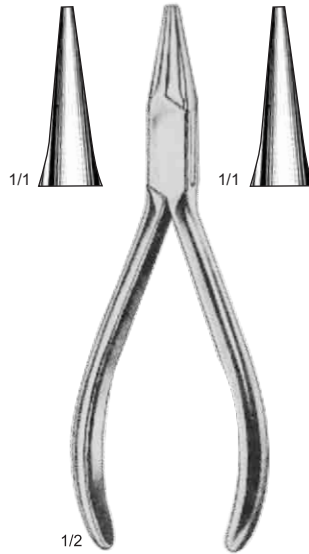

M-0972-14
14 cm
Round Nose Plier

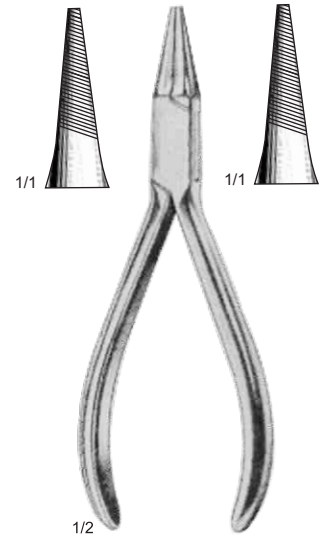

M-0973-14
14 cm

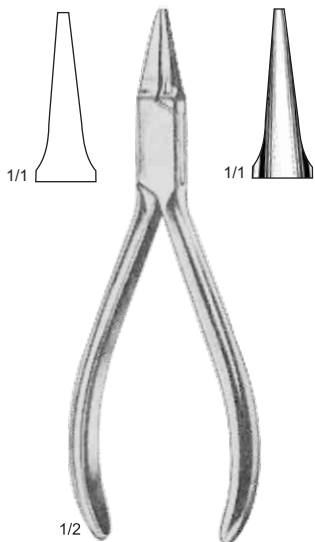

M-0974-14
14 cm



M-0975-13
13 cm



M-0976-13
13 cm

Angle

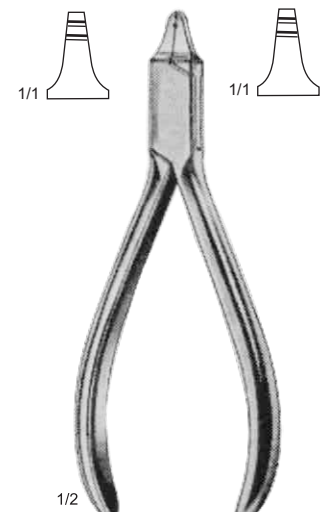

M-0977-13
13 cm
Oliver



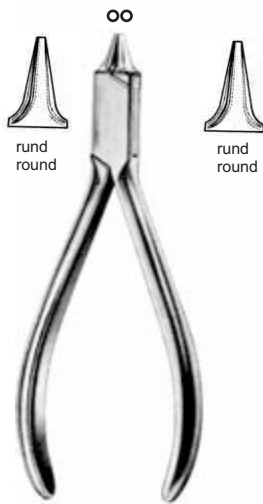

M-0978-12
12,5 cm

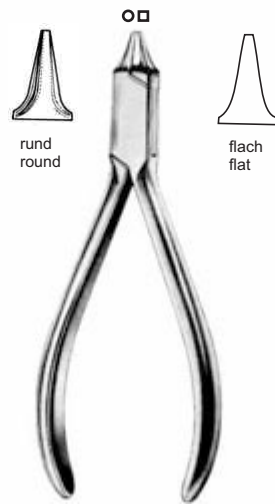

M-0979-12
Angle
12,5 cm

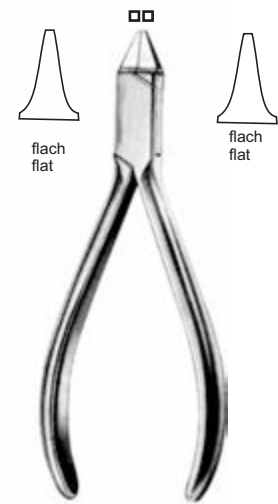

M-0980-12
Adams
12,5 cm

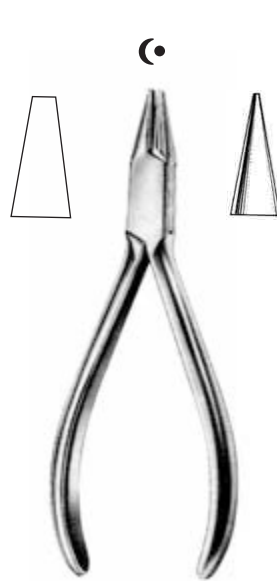

M-0981-13
13 cm

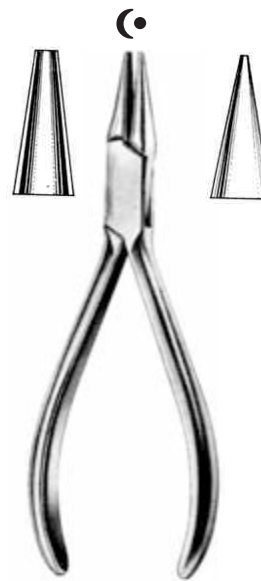

M-0982-14
Schwarz
14 cm

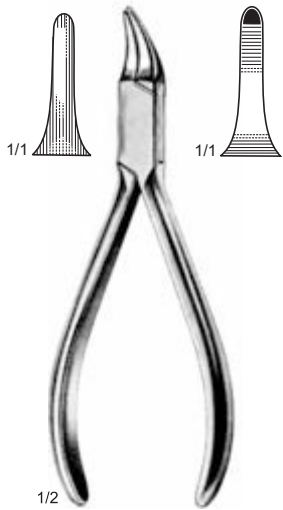

M-0983-13
Gordon
13,5 cm

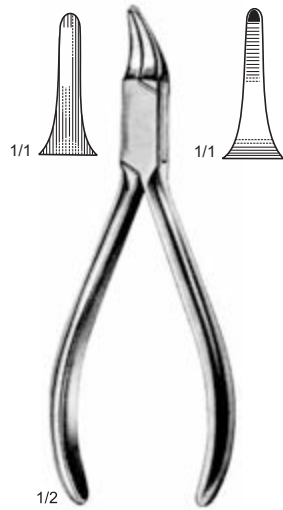

M-0984-13
Usa Modell
13,5 cm

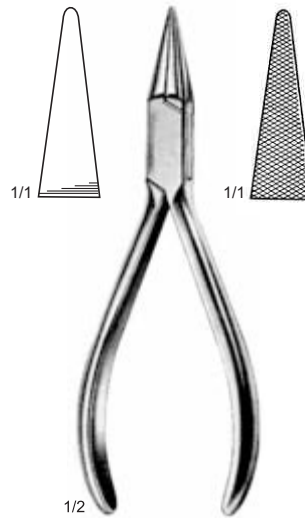

M-0985-13
Goslee
13,5 cm

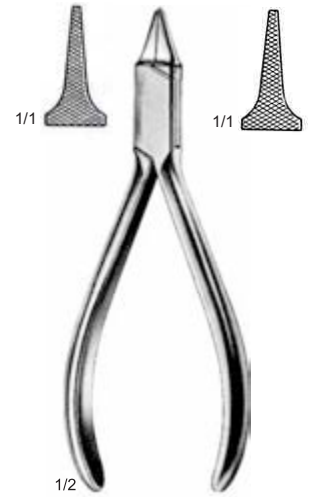

M-0986-13
Frevert
13 cm

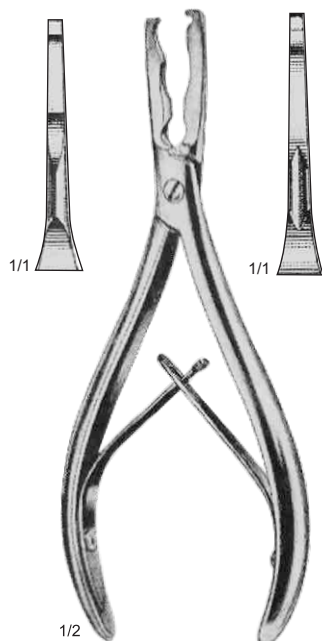

M-0987-16
Tryfus
16 cm

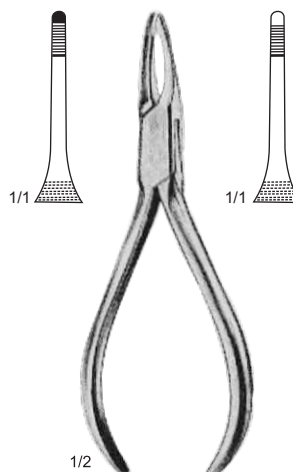

M-0988-12
Johnson
12 cm

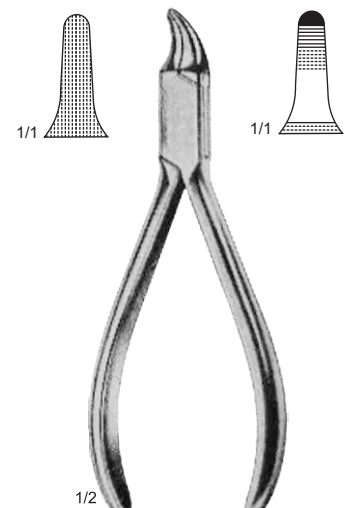

M-0989-13
Reynolds
13 cm

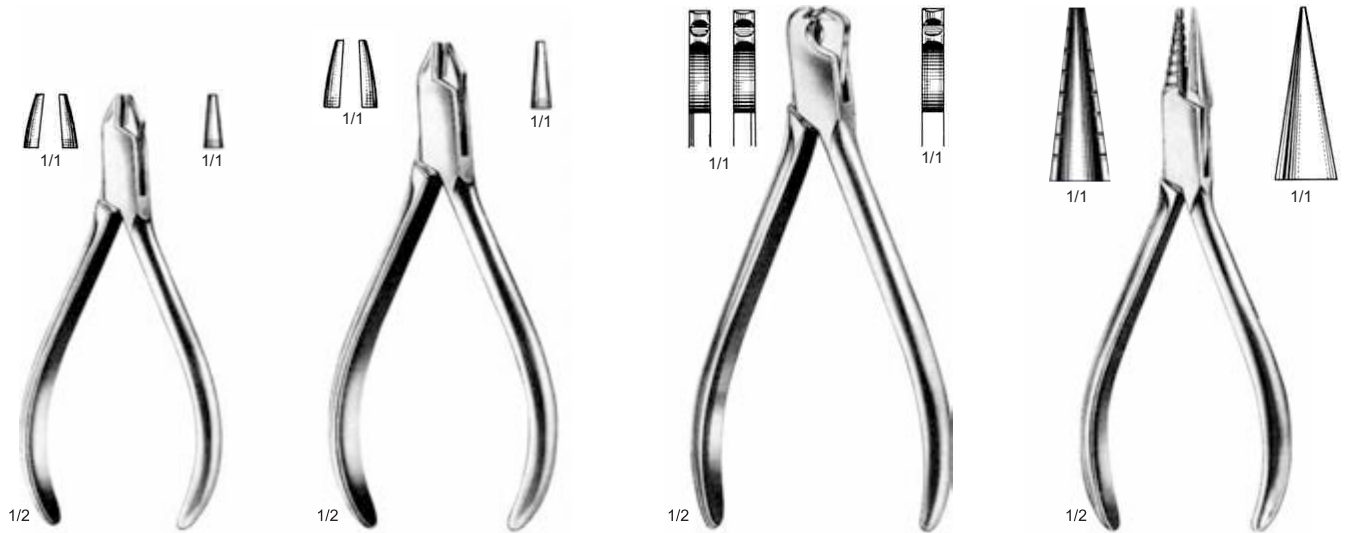

M-0990-11
Aderer
11,5 cm

M-0990-13
Aderer
13 cm

M-0990-14
Aderer
14 cm

M-0991-14
Schwarz
14 cm

Draht- und klammerbiegezeuge
Wire And Clasp Bending Pliers

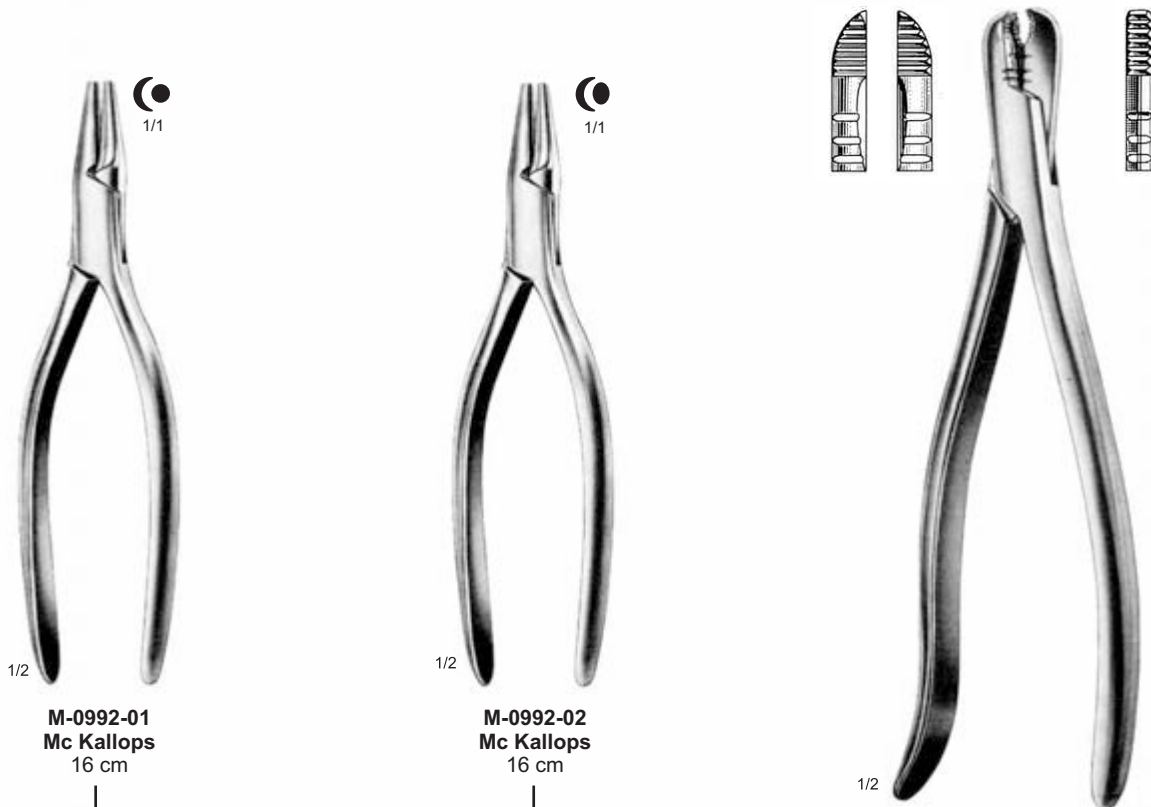

M-0992-01
Mc Kallops
16 cm

M-0992-02
Mc Kallops
16 cm

M-0993-21
Malotky
21 cm

Draht- und klammerbiegezeuge
Wire And Clasp Bending Pliers

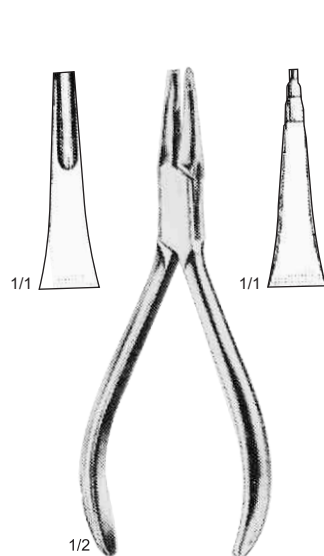

M-0994-13
Tweed
13.5 cm

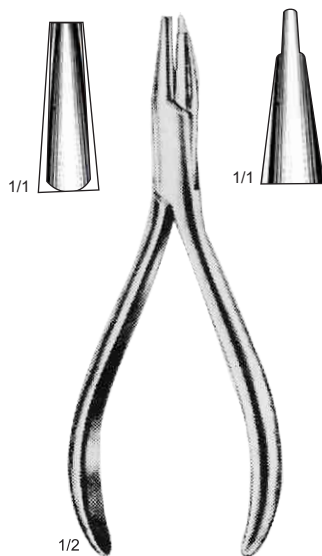

M-0995-14
Andersen
14 cm

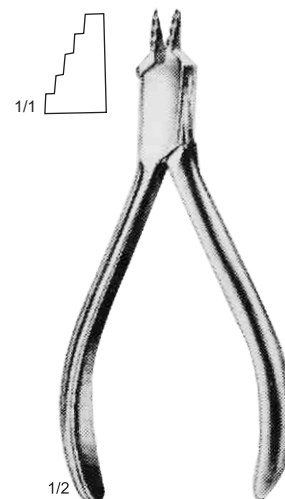

M-0996-13
Nance
13 cm

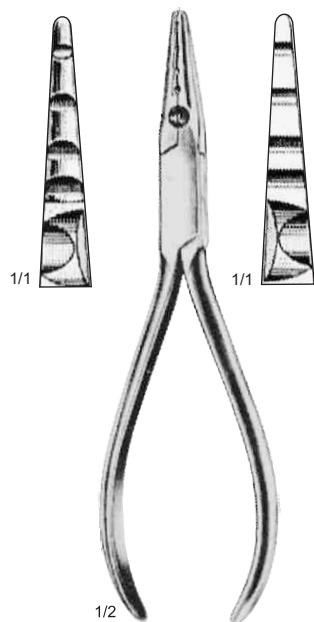

M-0997-16
16 cm

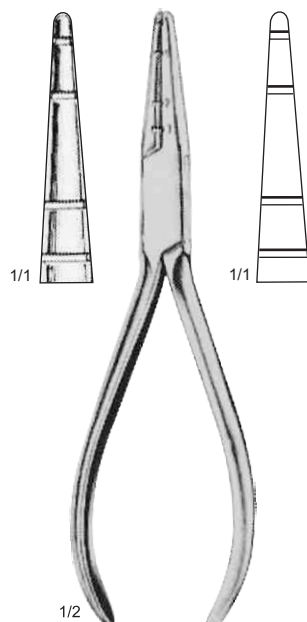

M-0998-16
Jelenko
16 cm

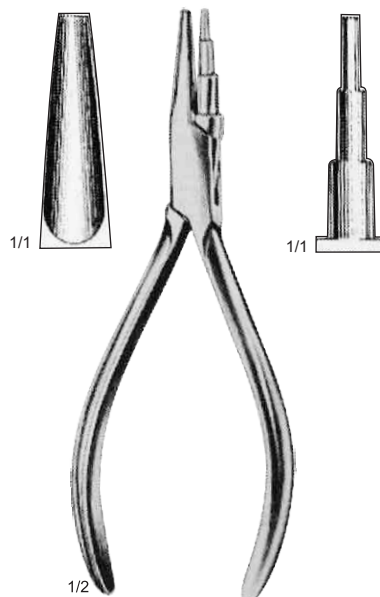

M-0999-15
15 cm

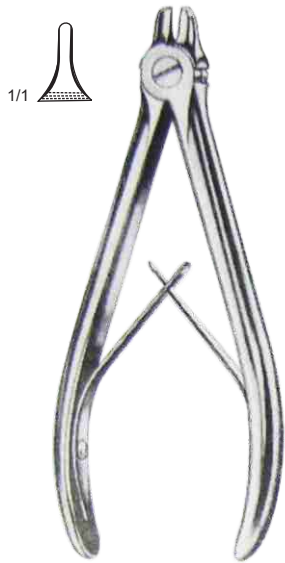

M-1000-14
Peeso
14.5 cm



M-1001-14
14.5 cm



M-1002-14
14.5 cm

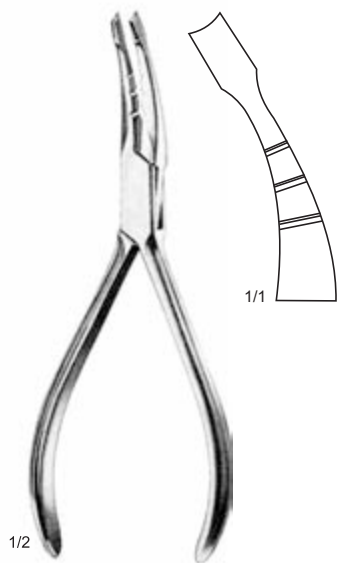

M-1003-14
Angle
Band Forming Plier
14.5 cm

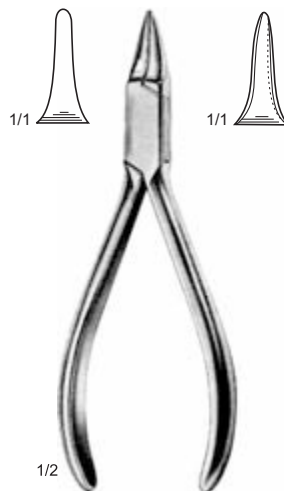

M-1004-01
Peeso
13 cm

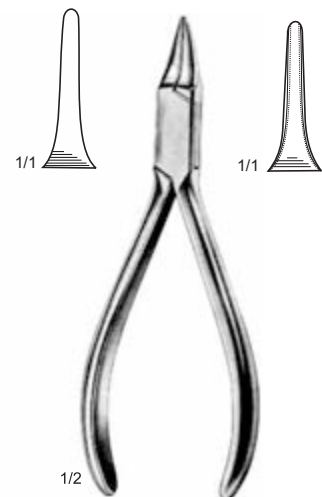

M-1004-02
Peeso
13 cm

Zahntechnische Zangen
Orthodontic Pliers

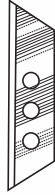

M-1005-18
MontFort
18 cm



1/2

M-1006-16
Baade
16 cm



1/2

M-1007-15
Furrer
15 cm

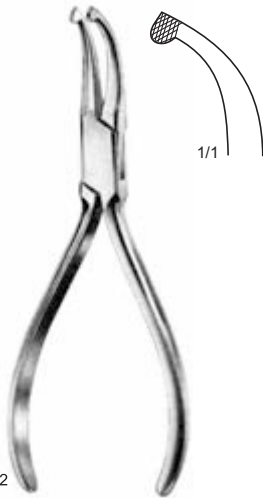

1/1

1/2

M-1008-01
How-Cur
13.5 cm

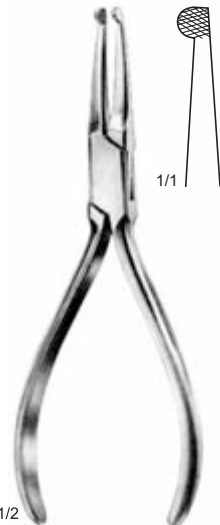

1/1

1/2

M-1008-02
How-Cur
14 cm

How



M-1009-01
Bohm
12 cm



M-1009-02
Bohm
12 cm



1/2
M-1010-14
Thplex
14.5 cm



1/2
M-1011-15
Universal
15 cm



M-1012-14
14 cm

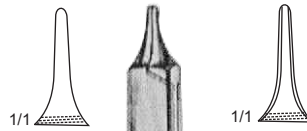

M-1013-13
Waldron
13 cm

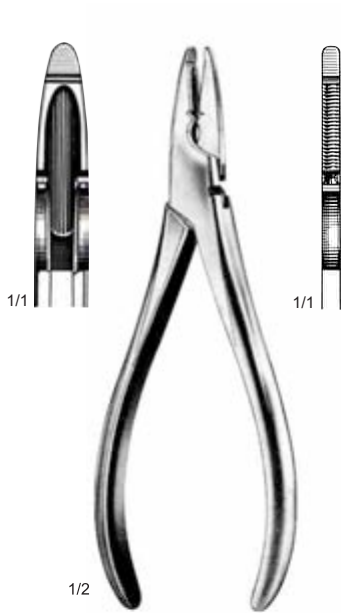

M-1014-15
Waldsachs
15 cm

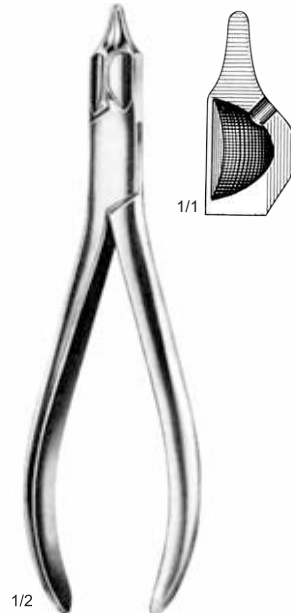

M-1015-16
16 cm

Universal-Kramponzangen
Universal Pin Bending Pliers



M-1016-16
16 cm

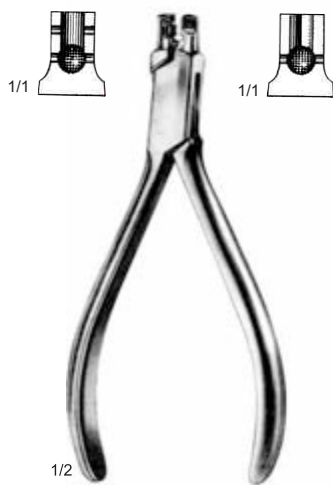

M-1017-01
Schwarz
12.5 cm

Klammerbiege­zangen
Arrow head clasp bending pliers



M-1017-02
Schwarz
12.5 cm

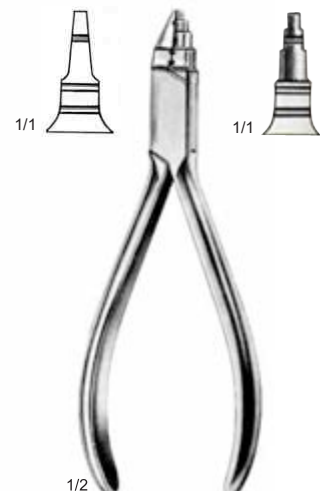

M-1018-01
Young

Drahtbiege­zangen
Wire bending pliers

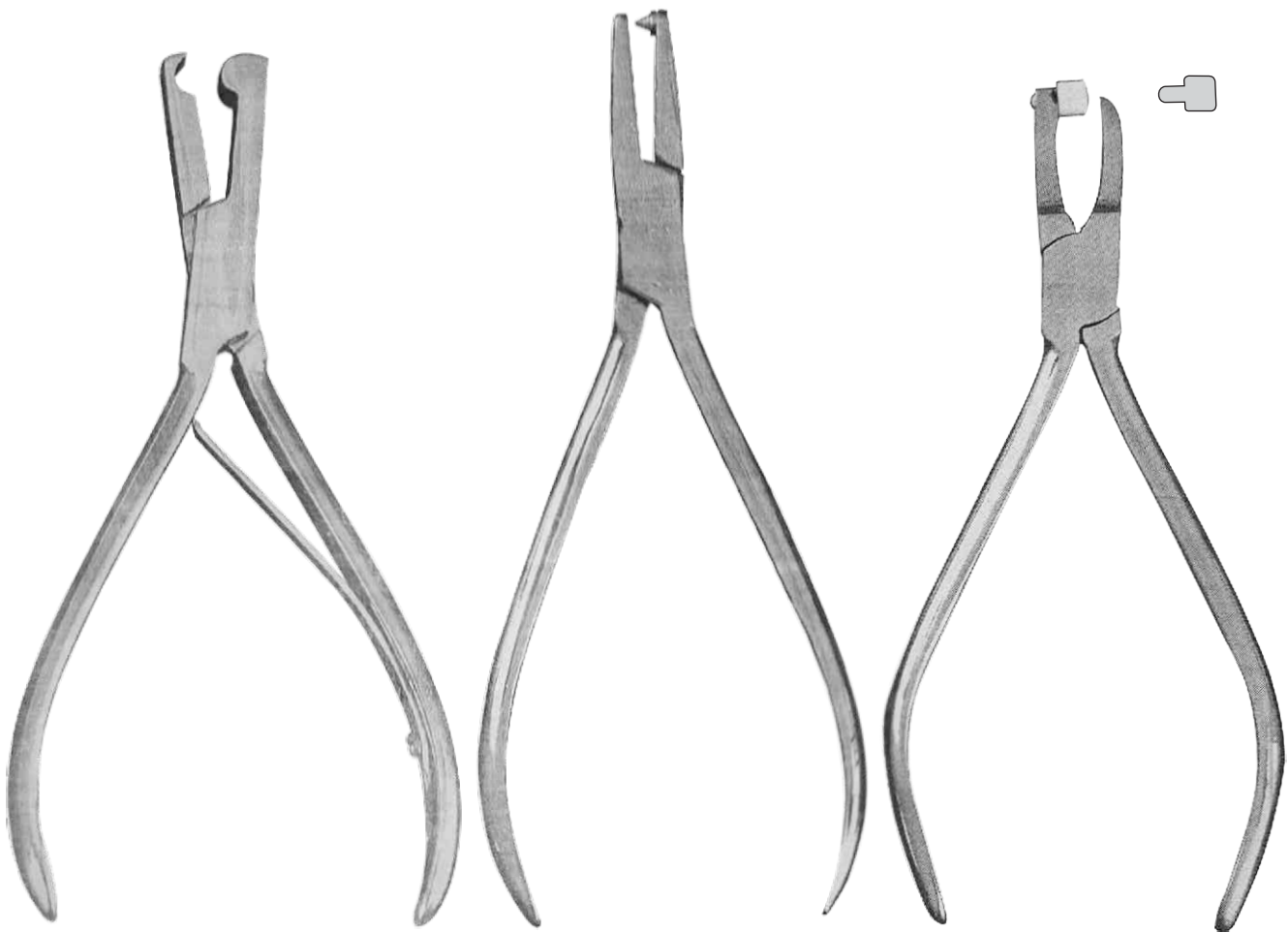

M-1019-14
De La Rose
14 cm

M-1020-14
No.141
14 cm

M-1021-12
Band Removing
with Plastic Pad
12 cm

TUNGSTEN CARBIDE INSERTS



M-1022-11
Ligature Cutter
11.7 cm



M-1023-11
Distal Cutter
11.5 cm



M-1023A-00



M-1024-11
Ligature Cutter
11.7 cm



M-1025-11
Distal Cutter
11.5 cm

TUNGSTEN CARBIDE INSERTS

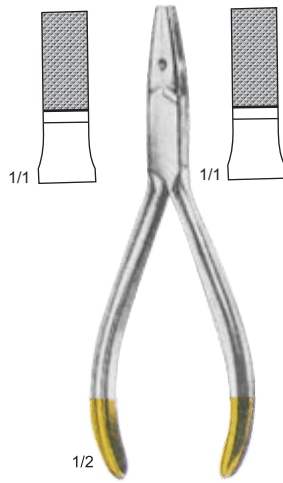

M-1026-14
14 cm

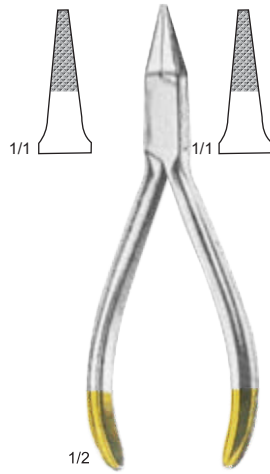

M-1027-13
13 cm

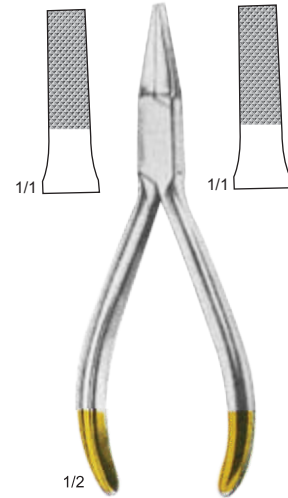

M-1028-14
14 cm

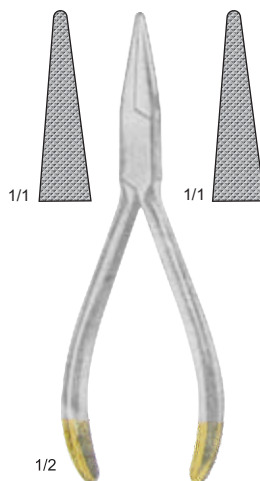

M-1029-14
14 cm

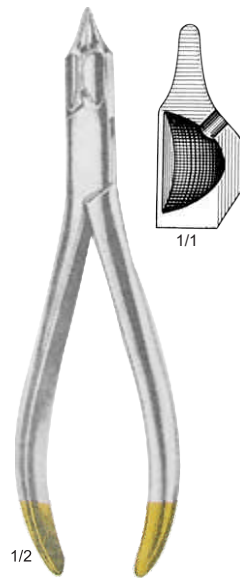

M-1030-16
Universal
16 cm

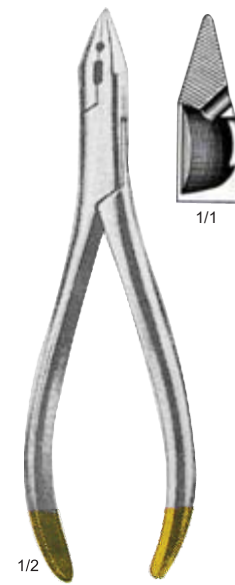

M-1031-16
Universal
16 cm



1/2

M-1032-12
12 cm



M-1033-13
End Nipoper
13 cm



M-1034-13
Side Nipper
13 cm



M-1035-16
Side Cutter of
Chrome-Vanadium
Steel
16 cm

TUNGSTEN CARBIDE INSERTS

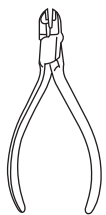

M-1036-00



M-1037-17
17.5 cm



M-1038-12
12 cm



1/1



M-1039-13
Weingart
13 cm

SKIPLINE

TC



M-1040-01
Hard Wire Cutter, Chrome

TC



M-1040-04
Direct Bond Remover, Wide



M-1040-07
Posterior Band Remover, Long



M-1040-10
Direct Bond Bracket Remover
(Wide, Replaceable Tip and Pad)



M-1040-13
Loop Forming Plier, Tweed Style

TC



M-1040-02
Detailing Step Plier



M-1040-05
Bird Beak Plier



M-1040-08
Light Wire Plier

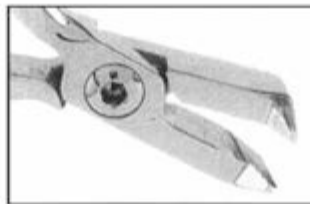

M-1040-11
Cinch Back Plier



M-1040-14
Weingart Utility Plier

TC

TWEED

TC



M-1040-03
Mini Pin and Ligature Cutter

TC



M-1040-06
45° Ligature Cutter



M-1040-09
Distal End Cutter, Flush Cut
with Safety Hold

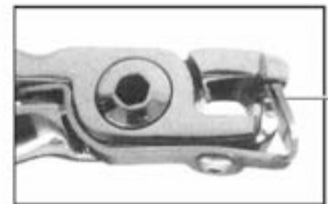

M-1040-12
Flush Cut Distal End Plier

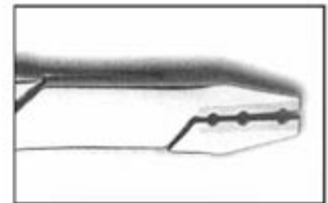

M-1040-15
Face Bow Adjusting Plier

NEW!

NEW!

SKIPLINE



M-1040-16
Omega Loop Forming Plier,
Tweed Style



M-1040-19
Jarabak Plier



M-1040-22
Lingual Arch Forming Plier



M-1040-25
Rectangular Arch Forming Plier



M-1040-27
Utility Plier (Weingart Style, Slim Tips)

TC



M-1040-17
Distal End Cutter,
Safety Hold

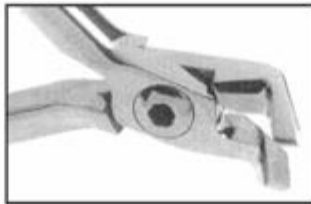

M-1040-20
Small Distal End Cutter,
Safety Hold



M-1040-23
Long Handled Distal End Cutter



M-1040-26
Straight Utility, How Style



M-1040-28
Offset Utility Plier, How Style

TWEED



M-1040-18
Band Seating Plier



M-1040-21
Ball Hook Crimping Plier



M-1040-24
Angled Ball Hook Crimping Plier

TC



M-1040-25
Rectangular Arch Forming Plier

TC



M-1040-27
Utility Plier (Weingart Style, Slim Tips)

NEW!



SEGITECH



www.segitech.net



M-1045-01
Original Buffalo
No. 6



M-1045-02
Original Buffalo
No. 7



M-1046-01



M-1047-01



M-1048-00
Gritman



M-1049-01



M-1050-01



M-1041-01
Ermert
13 cm

M-1041-02
Ermert
13 cm

M-1042-01
Fig.1
Lessmann
13 cm

M-1042-02
Fig.2
Lessmann
17 cm

M-1043-01
Fig.1
Fahnenstock
13 cm

M-1043-02
Fig.1
Fahnenstock
17 cm

M-1044-01
Fig.1
with small spoon
12.5 cm

M-1044-02
Fig.1
with small spoon
17 cm



M-1051-01

M-1052-01

M-1053-01

M-1054-01
Lichtenstein

M-1055-01



M-1056-00



M-1057-00
Plaster Shear
210 mm



M-1058-00



M-1059-00

Basic Set in Pouch Consisting of Following instruments

Mirrors No. 5 with handle

Excavator No. 17

Explorer No. 5

College Tweezer Serrated 15 cm



Mouth Mirror with Handle
Probe 17/23
U 15/30 Towner-Jacquette
College 15 cm

M-1060-01
Basic Tartar Scrapping Kit (4 Pcs)



Mouth Mirror with Handle
Explorer 17/23
Explorer 11/12 OUD
William Probe & Explorer
College 15 cm
Meriam 16.5 cm

M-1060-02
Dental Examination Kit(6 Pcs)

M-1060-04
Dental Laboratory Technicians Kit (10 Pcs)



Mouth Mirror with Handle
Explorer 17/23
College 15 cm

M-1060-03
Dental's Daily Kit (3 Pcs)



PK Thomas Fig. 1
PK Thomas Fig. 2
PK Thomas Fig. 3
PK Thomas Fig. 4
PK Thomas Fig. 5



Gritman 17.5 cm
Fahrenstock 13 cm
Fahrenstock 17cm
Zahle
Zahle

**M-1060-05
Plastic Filling Instruments Kit (5 Pcs)**

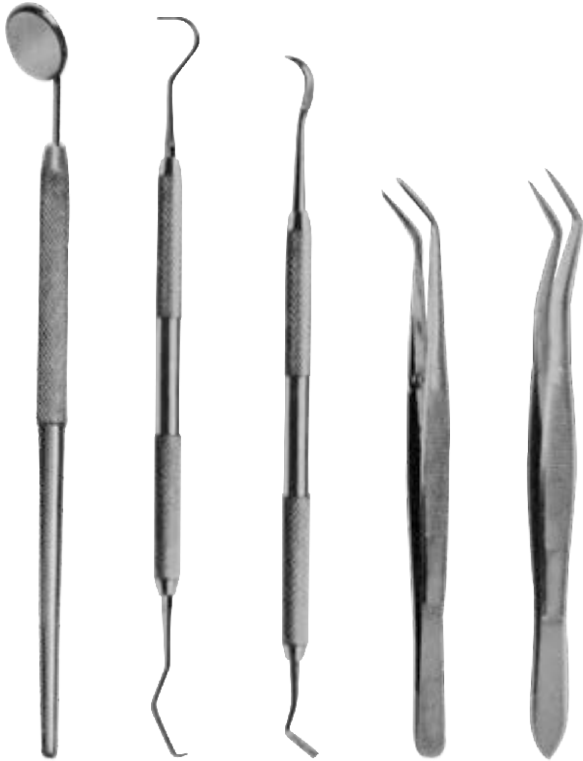

Mouth Mirror with Handle
Explorer 17/23
Plastic Filling Ins 2 mm/ 2mm
College 15 cm
Mariem 16.5 cm

**M-1060-06
Periodontal Examination Kit (6 Pcs)**



Mouth Mirror with Handle
Explorer 17/23
Explorer 11/12 OUD
Nabers Probe 2 N
Probe CP15 1.15mm
College 15 cm

**M-1060-07
Basic Rubber Dam Kit (8 Pcs)**



Ivory Punch
Ivory Light Weight Forceps
Rubber Dam Frame 6"

**M-1060-08
Microsurgery Basic Kit (4 Pcs)**



Castroviejo Scissor 14 cm Curved TC
Castroviejo Needle Holder 14 cm TC
Microsurgery Forceps 15 cm Curved TC
Microsurgery Scalpel Handle

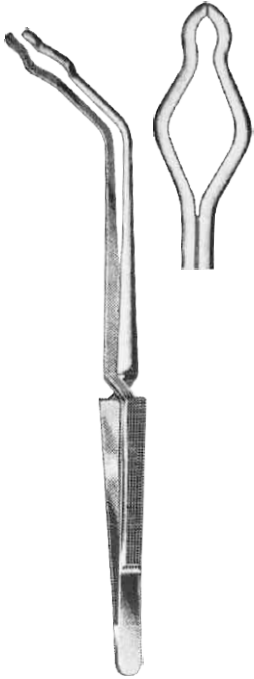

M-1061-01 18 cm
M-1061-02 25cm
Mod Martin



M-1062-01 16 cm
M-1062-02 20 cm
M-1062-03 24 cm
Davis

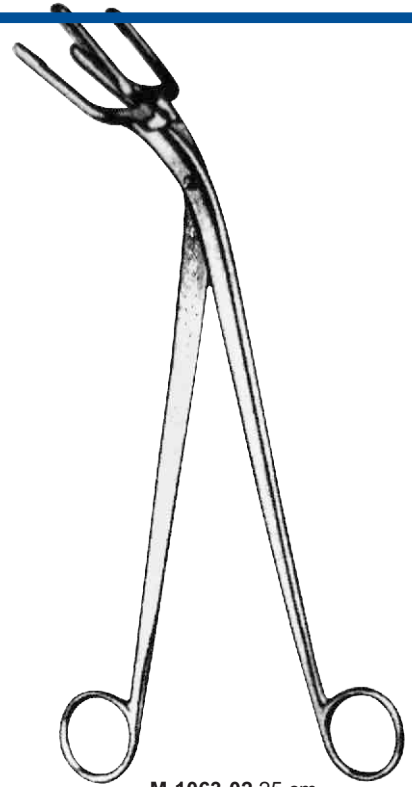

M-1063-02 25 cm
M-1063-03 30 cm
**Pye-Smith
(Harrison)**



M-1064-27
Cheatle
27 cm



M-1065-23
Rogge
23 cm



M-1066-01 20 cm
M-1066-02 25 cm
M-1066-03 30 cm



M-1067-24
24 cm

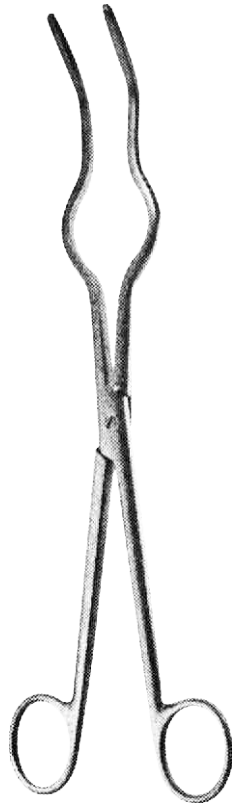

M-1068-24
24 cm
Ullevål



M-1069-20 20 cm
M-1069-28 28 cm

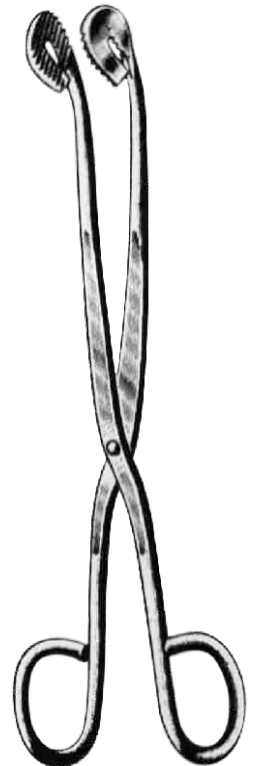

M-1070-20 20 cm
M-1070-28 28 cm

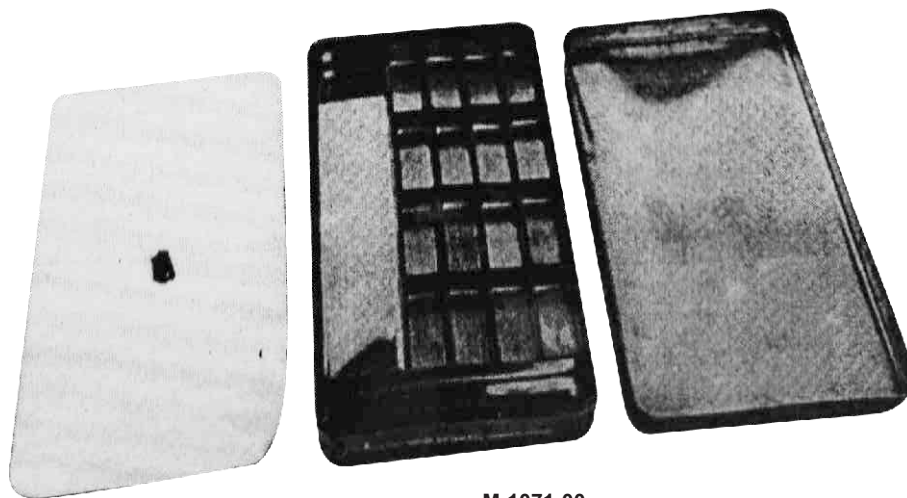

M-1071-00
Endodontics Tray
Curetage Case Double Cap

**Vassoi Portastrumenti
Instrument Trays**



M-1072-20
Instruments Cassette
Removable cover, Twist lock system
20 Instruments



M-1073-10
Instruments Cassette
Removable cover, Twist lock system
10 Instruments

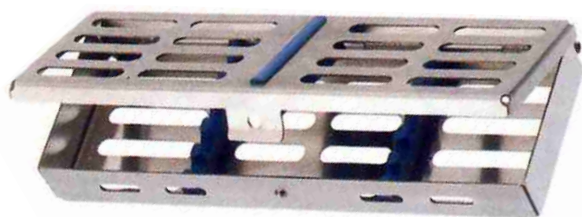

M-1074-05
Instruments Cassette
5 Instruments

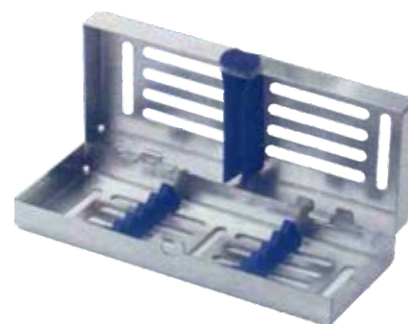

M-1075-05
Instruments Cassette
Removable cover, Twist lock system
5 Instruments

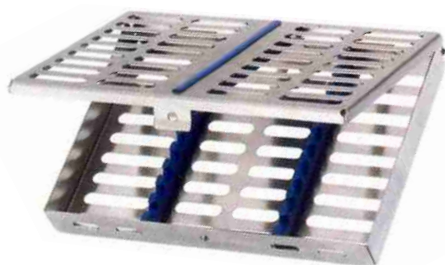

M-1076-10
Instruments Cassette
10 Instruments

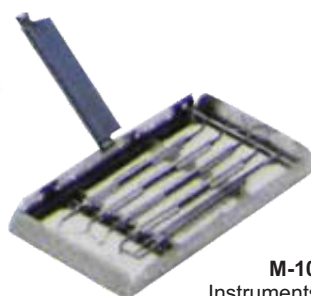

M-1078-05
Instruments Cassette
05 Instruments



M-1077-20
Instruments Cassette
20 Instruments



M-1079-00
Stainless Steel Sterilizing
Box includes a Finger tip silicone
Mat insert to facilitate sterilization
of handpieces. Perforated top made
of stainless dimension 255x155x20mm



M-1080-00
Stainless Steel Sterilizing
Box includes a Finger tip silicone
Mat insert to facilitate sterilization
of handpieces. Perforated top made
of stainless dimension 255x155x20mm



M-1081-00
Made of Stainless Steel Silicone
Instruments Holder Medium Cassette
for 10 instruments Silicone is Available
in Assorted colors.
Dimension 188x135x22mm

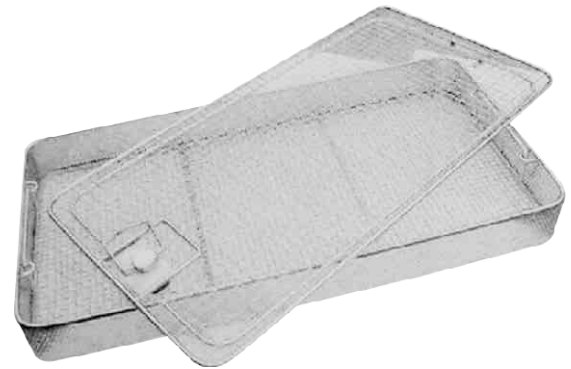

M-1082-00
Sterilization Basket with
Cross-hatched Flat Based
Mesh, Lockable & removable
Dimension 480x228x55mm



M-1083-00
Sterilization Basket with
Cross-hatched Flat
Based Mesh, Lockable & Removable lid.
Dimension 240x250x107mm

Vassoi Portastrumenti Instrument Trays

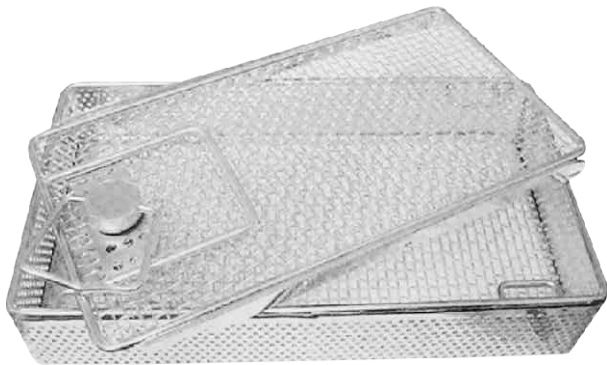

M-1084-00
The Base is Crimped wire Mesh
with opening Mesh cross-hatched flat
Based Mesh and Perforated sides
and removable lid
Dimension 220x125x40mm



M-1085-00
Instruments Tray
Dimension 240x130x50mm

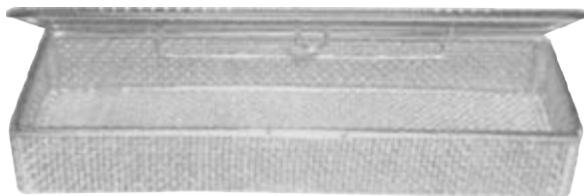

M-1086-00
Instruments Tray
Dimension 230x80x40mm

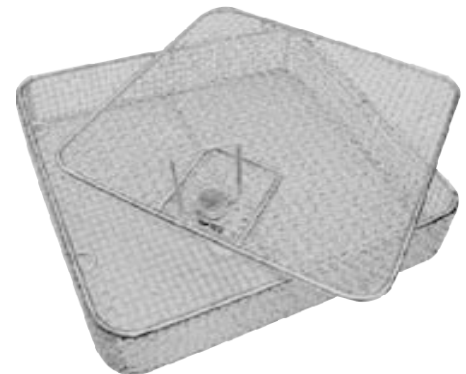

M-1087-00
Sterilization Basket with
Cross-hatched Flat based
Mesh, Lockable & Removable
Dimension 240x250x57mm

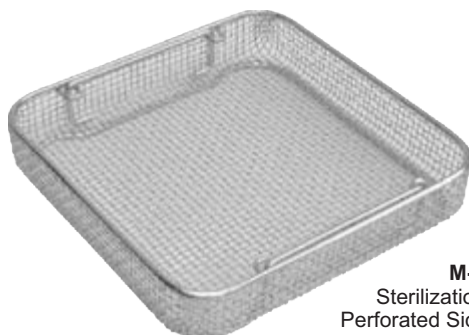

M-1088-00
Sterilization Basket with
Perforated Sides Crosshatched
Flat Based Mesh
without Lid
Dimension 250x235x50mm

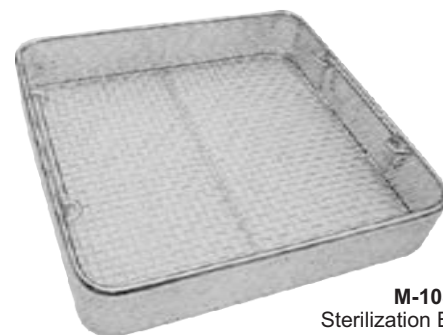

M-1089-00
Sterilization Basket with
Cross-hatched Flat based
Mesh, Lockable & Removable
Dimension 255x228x55mm

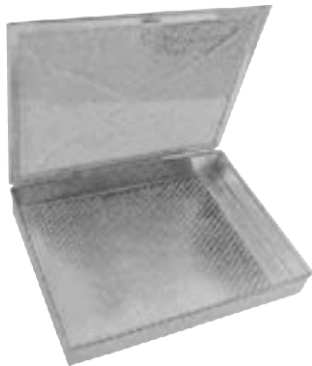

M-1090-00
Solid Sides, Perforated
Base & Top is crimped
Wire Mesh with top opening
Dimension



M-1091-00
Perforated Tray
288 x 187 x 40 mm
180 x 140 x 40 mm



M-1092-00
Perforated Tray
288 x 187 x 40 mm
180 x 140 x 40 mm



M-1093-00
Perforated Tray
288 x 187 x 40 mm
180 x 140 x 40 mm



M-1094-00
Instruments Tray & Cover
8" x 6" x 2"
10" x 8" x 2"
12" x 7" x 2"



M-1095-00
Instruments Tray
8" x 4" x 1"



M-1096-00
Instruments Tray Perforated
12" x 6" x 1"



M-1097-00
Instruments Tray Shallow Mayo
8" x 6" x 1"
9" x 6" x 1"
12" x 8" x 2"



M-1098-00
Scaler Tray
200 x 100 x 15 mm
200 x 150 x 15 mm

**Instrumentenbehalter
Instruments Boxes**



M-1099-00
Catheter Tray
222 x 82 x 40 mm
225 x 125 x 50 mm
325 x 90 x 50 mm



Code	Size
M-1100-01	17 x 7 x 3 cm
M-1100-02	17.5 x 7.5 x 3 cm
M-1100-03	18 x 6 x 3 cm
M-1100-04	18 x 7 x 3 cm
M-1100-05	18 x 9 x 4 cm
M-1100-06	20 x 10 x 4 cm
M-1100-07	21 x 10 x 4 cm

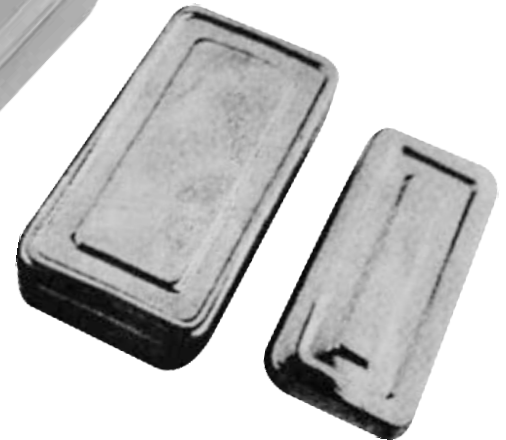

Instruments Boxes
in Different Sizes

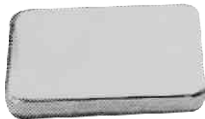

M-1101-00
Needle Case



M-1102-01 (5 cc)
M-1102-02 (2 cc)
Syringes Case



M-1103A-0A
Finger Cup

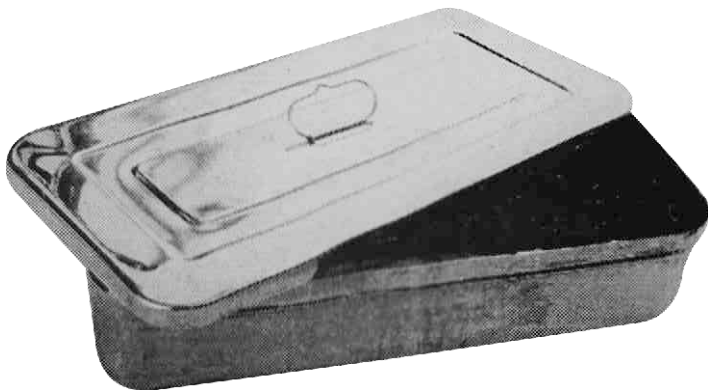

Code	Size
M-1103-01	30 x 15 x 10 cm
M-1103-02	30 x 17 x 5 cm
M-1103-03	34 x 16 x 5 cm
M-1103-04	36 x 24 x 5 cm
M-1103-05	36 x 24 x 10 cm
M-1103-06	40 x 20 x 6 cm

Instruments Boxes
in Different Sizes

Code	Size
M-1104-01	40 x 20 x 10 cm
M-1104-02	40 x 30x 5 cm
M-1104-03	40 x 30x 10 cm
M-1104-04	42 x 19 x 5 cm
M-1104-05	42 x 30 x 5 cm
M-1104-06	45 x 30 x 10 cm

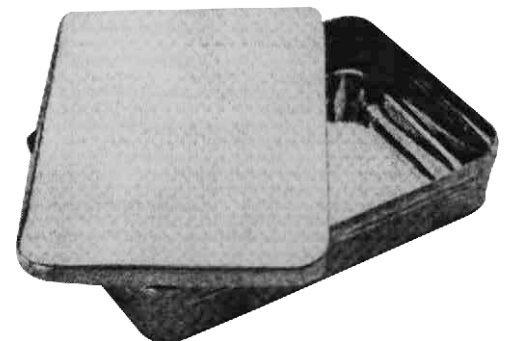

Code	Size
M-1105-01	23 x 15x 5 cm
M-1105-02	25 x 12x 5 cm
M-1105-03	25 x 12x 10 cm
M-1105-04	26 x 15 x 5 cm
M-1105-05	30 x 15 x 5 cm
M-1105-06	32 x 6 x 4 cm



M-1106-00 27 x 12 x 6 cm
Sterilizer With Heater



Code	Size	Code	Size
M-1107-01	24 x 12 cm	M-1108-01	34 x 28 cm
M-1107-02	30 x 15 cm	M-1108-02	37 x 30 cm
M-1107-03	30 x 30 cm	M-1108-03	39 x 14 cm
M-1107-04	34 x 16 cm	M-1108-04	39 x 20 cm
M-1107-05	34 x 24 cm	M-1108-05	39 x 29 cm

Dressing/ Sterilizing Drum
in Different Sizes

Code	Size
M-1109-01	8 x 8 cm
M-1109-02	10 x 10 cm
M-1109-03	12 x 12 cm
M-1109-04	16 x 12 cm
M-1109-05	18 x 18 cm
M-1109-06	19 x 14 cm
M-1109-07	19 x 20 cm
M-1109-08	20 x 16 cm
M-1109-09	20 x 20 cm
M-1109-10	24 x 16 cm
M-1109-11	24 x 24 cm
M-1109-12	29 x 14 cm
M-1109-13	29 x 16 cm
M-1109-14	29 x 24 cm

Dressing/ Sterilizing Drum
in Different Sizes

**Sterilising/Prapariertrommel
Sterilizing/ Dressing Drum**



Code	Size
M-1110-01	20 x 10 x 5 cm
M-1110-02	25 x 12 x 5 cm
M-1110-03	26 x 15 x 5 cm

Boiling Sterilizer with
Perforated Tray Stand
and Lifter



Code	Size	Code	Size
M-1111-01	7.5 x 7.5 cm	M-1112-01	18 x 18 cm
M-1111-02	10 x 10 cm	M-1112-02	10 x 12.5 cm
M-1111-03	12.5 x 12.5 cm	M-1112-03	20 x 20 cm
M-1111-04	15 x 18 cm		

Boiling Sterilizer with Perforated Tray Stand and Lifter



Code	Size
M-1113-01	5 x 11.5 cm
M-1113-02	5 x 16.5 cm

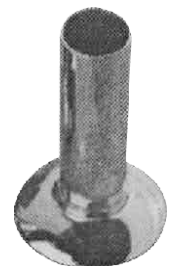

Code	Size
M-1114-00	3 x 11 cm

Thermometer Jar

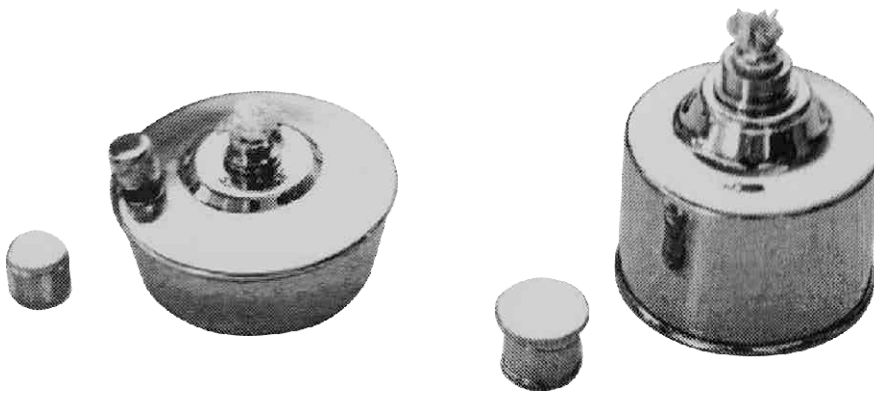

M-1115-01
4 oz

M-1115-02
4 oz
6 oz



M-1116-01
Ounces
10, 20, 40, 60, 80



M-1116-02
Ounces
40

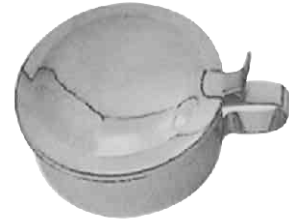

M-1117-00
Spitten Mug



M-1118-10 10 cm
M-1118-12 12 cm
M-1118-15 15 cm
M-1118-20 20 cm
M-1118-25 25 cm
Lotion Bowl



M-1119-01 50 cc
M-1119-02 100 cc
Medicine Cup



M-1120-01 80 x 50 mm
Iodine Cup



M-1121-00
Cotton Wool Holder



Code	Size
M-1122-01	9.5 x 5.4 x 1 cm
M-1122-02	15 x 10 x 1 cm
M-1122-03	18.5 x 10.5 x 1 cm
M-1122-04	19 x 10x 1.5 cm
M-1122-05	20 x 10 x 1 cm
M-1122-06	20 x 15 x 1 cm
M-1122-07	25 x 15 x 1 cm
M-1122-08	28 x 19 x 2 cm
M-1122-09	29 x 19 x 1 cm

Instruments Tray



Code	Size
M-1123-12	12 cm
M-1123-15	15 cm
M-1123-20	20 cm
M-1123-25	26 cm
M-1123-30	30 cm

Kidney Tray

**endodontische Boxen
Endodontic Boxes**

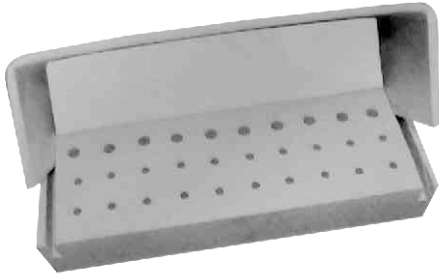

M-1124-00
Endo Bur Block / Holder
for 30 Holes, made of
Clinical Grade of
Aluminum Available
in assorted Colors



M-1125-00
Hu Friedy Endodontic Stand
Holders for 24 Files & Reamers
Made of stainless



M-1126-00
Endo Bur Block / Holder
with Clinical Grade of
Aluminum for 48 Holes
Available in assorted colors



M-1127-00
Endo Storage Bur Block / Holder
with Box for 216 Holes for Burs,
Files, Reamers, Finger Spreaders
Gutta Percha points, paper Points
Etc. Made of Clinical Grade of Aluminum

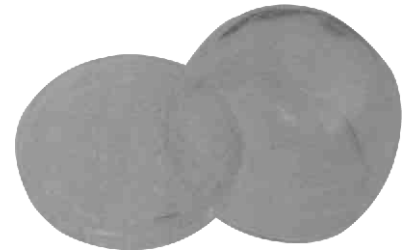

M-1129-00
Open Top, Crystal Endo Bur Holders,
Holes, 33 Bur & Reamers,
Made of Clinical Grade Pc



M-1128-00
Endo Storage Box Holds 72
Instruments, Aluminum
Construction Autoclavable
or Dry Heat, Available in
Assorted Colors
Dimension 4" x 1 1/3" x 2 1/2"



M-1130-00
Round Endo Storage Bur
for Burs, Files Reamers,
Finger Spreaders, Gutta
Percha Points, Paper Point
Etc, Made of Clinical Grade of Aluminum



M-1131-00
Endo Bur Block / Holder
for 15 Holes Made of Clinical
Grade of Aluminum Available
in Assorted Colors



SEGITECH



www.segitech.net

M-1132-01
M-1133-02

M-1134-1UP

M-1134-4DR

M-1135-1LP

M-1135-4SL

		A mm.	B mm.
M-1132-U1	XXS	56	44
M-1132-U2	XS	65	52
M-1132-U3	S	68	54
M-1132-U4	M	71	58
M-1132-U5	L	73	59
M-1132-U6	XL	78	63

		A mm.	B mm.
M-1133-L1	XXS	56	44
M-1133-L2	XS	66	50
M-1133-L3	S	70	52
M-1133-L4	M	73	56
M-1133-L5	L	76	58
M-1133-L6	XL	78	60

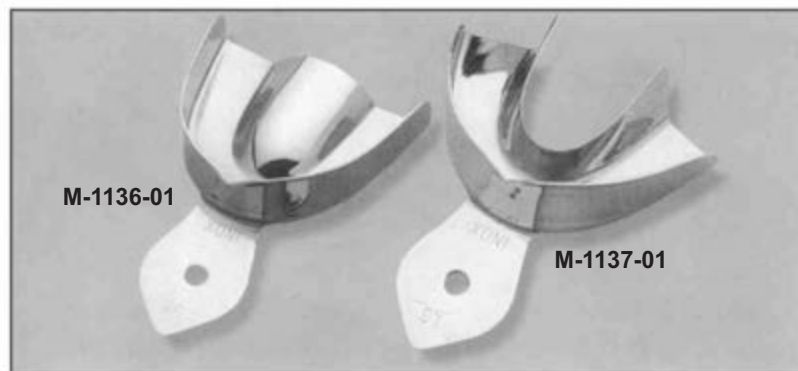
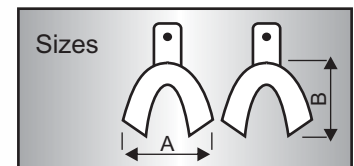
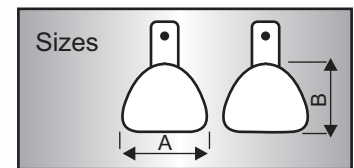
M-1136-01
M-1137-01

M-1138-4DR

M-1139-4SL

		A mm.	B mm.
M-1136-U1	XXS	56	44
M-1136-U2	XS	65	52
M-1136-U3	S	68	54
M-1136-U4	M	71	58
M-1136-U5	L	73	59
M-1136-U6	XL	78	63

		A mm.	B mm.
M-1137-L1	XXS	56	44
M-1137-L2	XS	66	50
M-1137-L3	S	70	52
M-1137-L4	M	73	56
M-1137-L5	L	76	58
M-1137-L6	XL	78	60

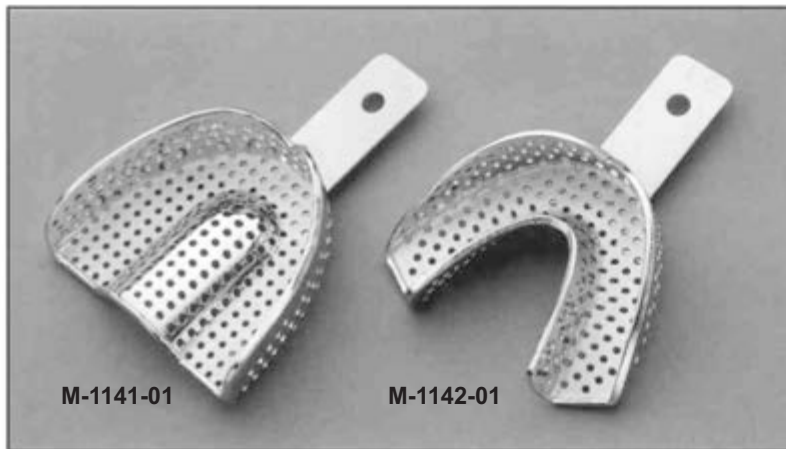

**M-1140-01
Check Bite**

Abdruckloffel Impression Trays

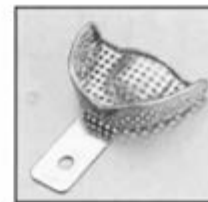

M-1141-01

M-1142-01



M-1143-1UP



M-1143-4DR

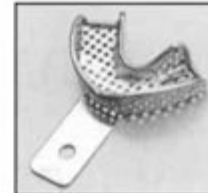

M-1144-1LP



M-1144-4SL

		A mm.	B mm.
M-1141-U1	XXS	56	44
M-1141-U2	XS	65	52
M-1141-U3	S	68	54
M-1141-U4	M	71	58
M-1141-U5	L	73	59
M-1141-U6	XL	78	63

		A mm.	B mm.
M-1142-L1	XXS	56	44
M-1142-L2	XS	66	50
M-1142-L3	S	70	52
M-1142-L4	M	73	56
M-1142-L5	L	76	58
M-1142-L6	XL	78	60

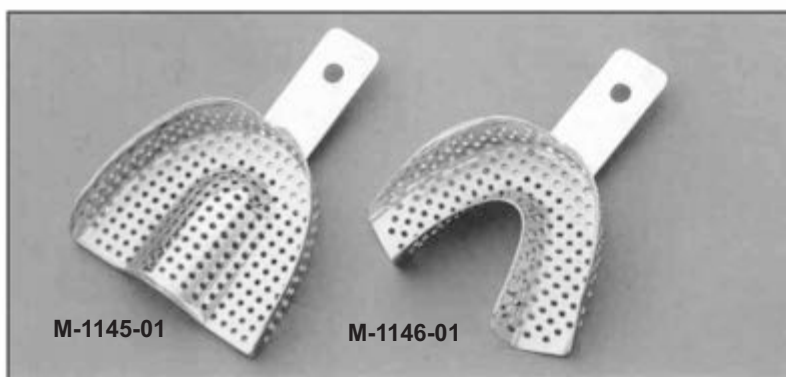
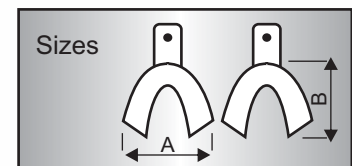
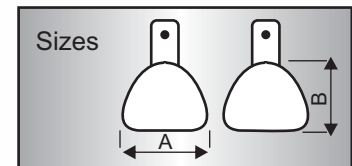

M-1145-01

M-1146-01



M-1147-4DR



M-1147-4SL

		A mm.	B mm.
M-1145-U1	XXS	56	44
M-1145-U2	XS	65	52
M-1145-U3	S	68	54
M-1145-U4	M	71	58
M-1145-U5	L	73	59
M-1145-U6	XL	78	63

		A mm.	B mm.
M-1146-L1	XXS	56	44
M-1146-L2	XS	66	50
M-1146-L3	S	70	52
M-1146-L4	M	73	56
M-1146-L5	L	76	58
M-1146-L6	XL	78	60

Denture / Edentulous

Set of 8 Pieces

		A mm.	B mm.
M-1148-U1	S	73	60
M-1148-U2	NM	70	64
M-1148-U3	M	76	67
M-1148-U4	L	79	70

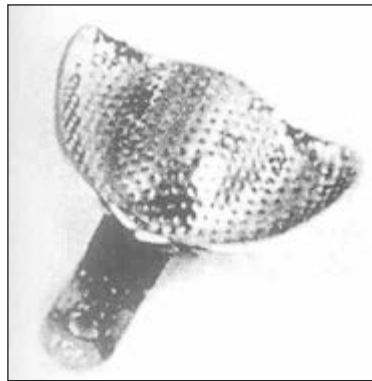

		A mm.	B mm.
M-1149-U1	S	70	57
M-1149-U2	M	73	60
M-1149-U3	NL	70	64
M-1149-U4	L	79	70

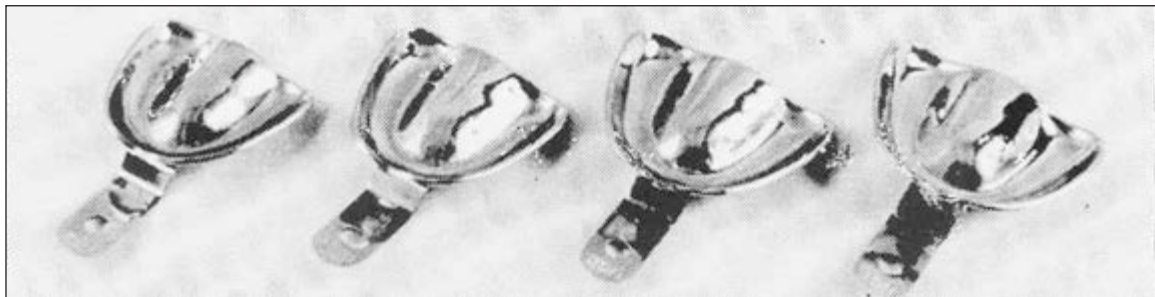
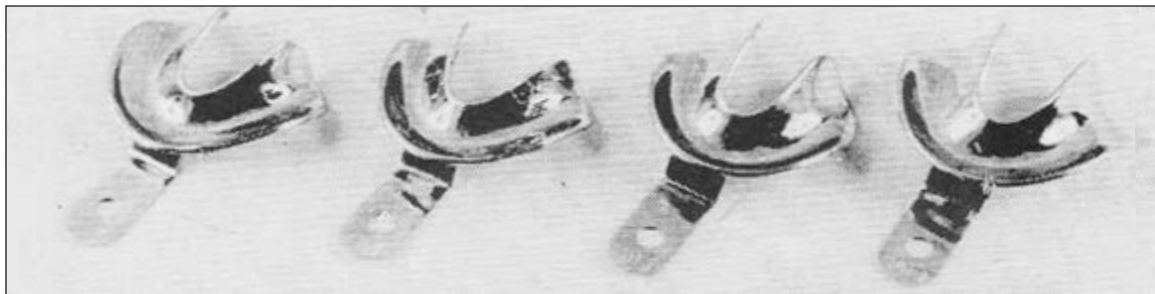
M-1148-U1
M-1148-U2
M-1148-U3
M-1148-U4

M-1149-U1
M-1149-U2
M-1149-U3
M-1149-U4

Ehricke (Non Perforated)

Code	Size
M-1150-UO1	UO1
M-1150-UO2	UO2
M-1150-UO3	UO3



Code	Size
M-1151-UU1	UU1
M-1151-UU2	UU2
M-1151-UU3	UU3



Code	Size
M-1152-BO0	BO0
M-1152-BO1	BO1
M-1152-BO2	BO2
M-1152-BO3	BO3
M-1152-BO4	BO4

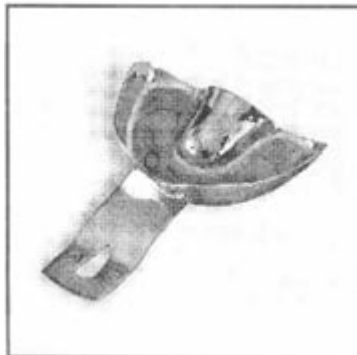

Code	Size
M-1153-BU0	BU0
M-1153-BU1	BU1
M-1153-BU2	BU2
M-1153-BU3	BU3
M-1153-BU4	BU4



Code	Size
M-1154-PO1	PO1
M-1154-PO2	PO2
M-1154-PO3	PO3



Code	Size
M-1155-PU1	PU1
M-1155-PU2	PU2
M-1155-PU3	PU3



Ehricke (Perforated)

Code	Size
M-1156-UO1	UO1
M-1156-UO2	UO2
M-1156-UO3	UO3

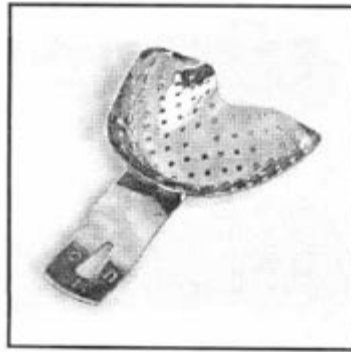

Code	Size
M-1157-UU1	UU1
M-1157-UU2	UU2
M-1157-UU3	UU3

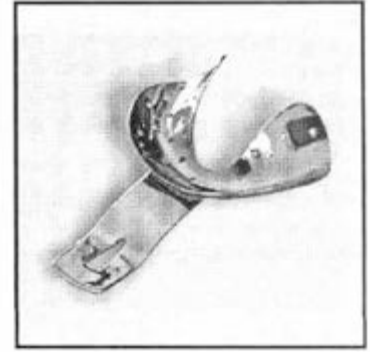

Code	Size
M-1158-BO0	BO0
M-1158-BO1	BO1
M-1158-BO2	BO2
M-1158-BO3	BO3
M-1158-BO4	BO4

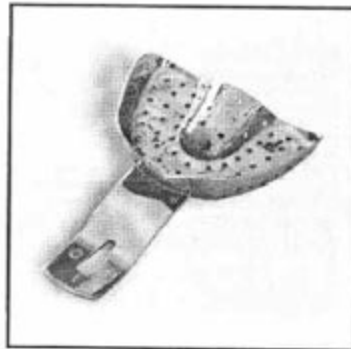

Code	Size
M-1159-BU0	BU0
M-1159-BU1	BU1
M-1159-BU2	BU2
M-1159-BU3	BU3
M-1159-BU4	BU4



Code	Size
M-1160-PO1	PO1
M-1160-PO2	PO2
M-1160-PO3	PO3

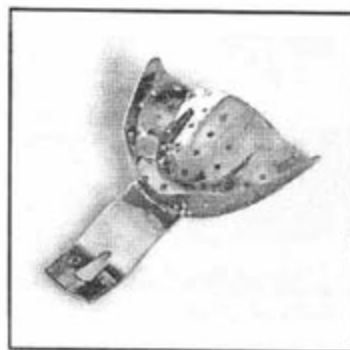

Code	Size
M-1161-PU1	PU1
M-1161-PU2	PU2
M-1161-PU3	PU3





M-1165-00

Articulator with An Excellent degree of Accuracy
Its functionality Makes Easier Both the Procedures
of Taking & Transferring the patient's records &
The Process of Mounting the models



M-1166-00
Semi Adjustable,
anatomical Articulator

Edentulous

Set of 11 Pieces (without Rim Lock)

Code	Size	A mm.	B mm.
M-1162-U1	XXS	60	50
M-1162-U2	XS	64	54
M-1162-U3	S	68	58
M-1162-U4	M	70	60
M-1162-U5	L	78	64

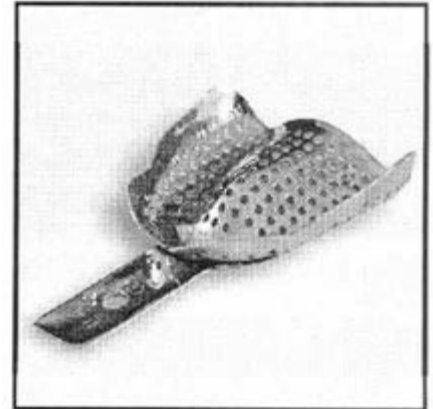

Code	Size	A mm.	B mm.
M-1163-L1	XXS	60	54
M-1163-L2	XS	67	55
M-1163-L3	S	70	56
M-1163-L4	M	74	58
M-1163-L5	L	76	60
M-1163-L6	XL	80	62

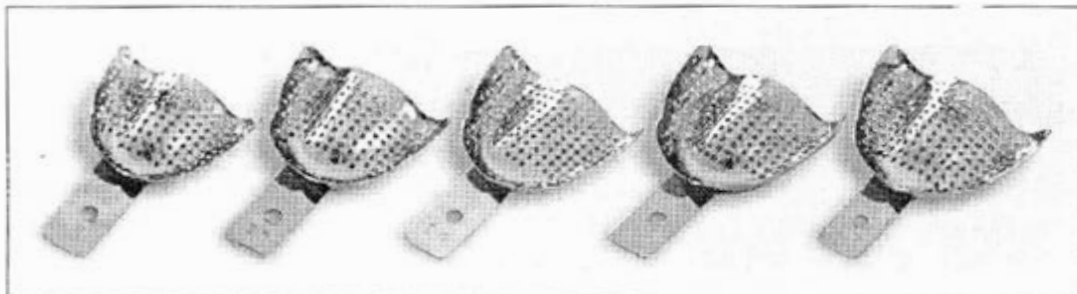
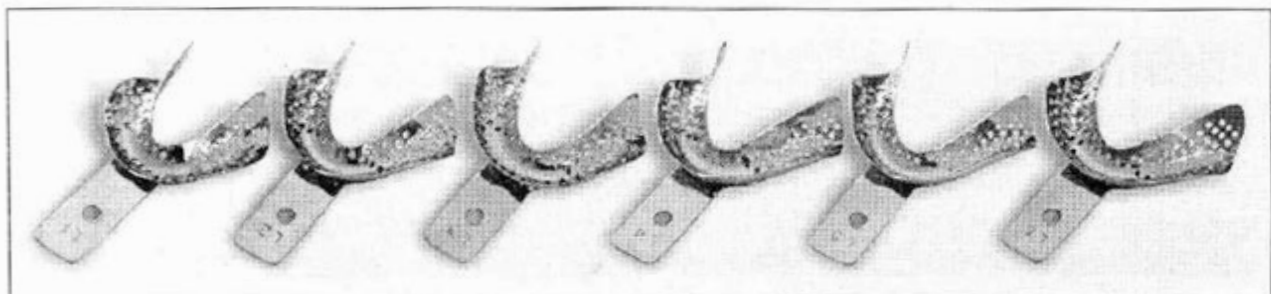

M-1162-U1 M-1162-U2 M-1162-U3 M-1162-U4 M-1162-U5

M-1163-U1 M-1163-U1 M-1163-U2 M-1163-U3 M-1163-U4 M-1163-U5

Articulators Plaster Less

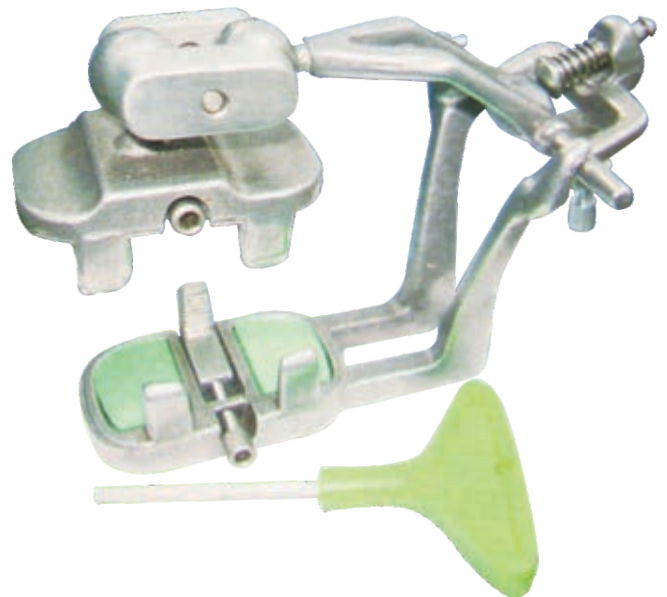

M-1167-00
Magic Art-11 Articulator Securely Hole
Quadrant Models, Conserve Materials
& Time! Quickly & Easily Mount
Pre-cast Dental Models.

M-1168-00
Magic Art-11 Articulator Securely Hole
Quadrant Models, Conserve Materials
& Time! Quickly & Easily Mount
Pre-cast Dental Models.



M-1169-00
Anatomical Articulator universal, Realized
for Easy Visibility to The Lingual surface
& for A Perfect stability also in Reserved
Position also Available in Assorted Colors



M-1170-00
Articulator with a Ball Slot Type Path
on The Maxillary Frame



M-1171-00
Anatomical Articulator ASA with
Bearing Rod & Incisive Pin - Consructed
of Metal Alloy Casting Available in
Assorted Colors



M-1172-00
Articulator with Lateral Movement
Made of Aluminum Die Casting with
2 Mounting Plates also Available in
Vibratory Polished Process & Assorted Colors

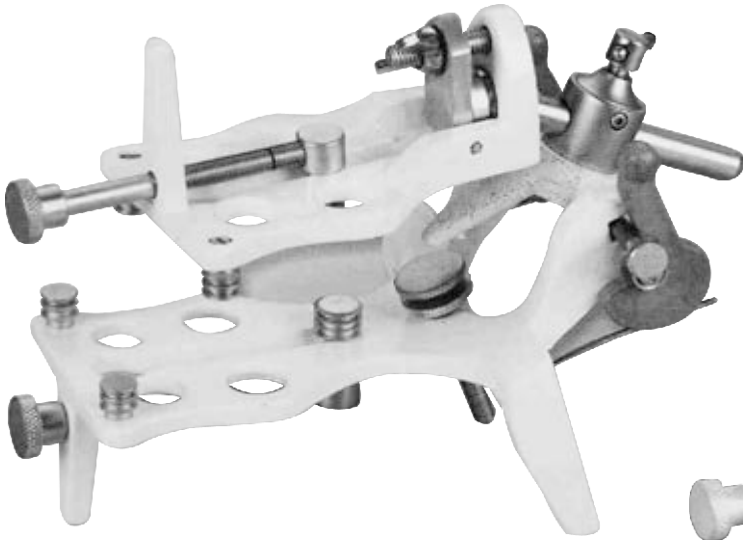

M-1173-00
High Tech Plasteriess Articulator
with Adjustable screws at Rears &
Front All anatomical Movement Possible

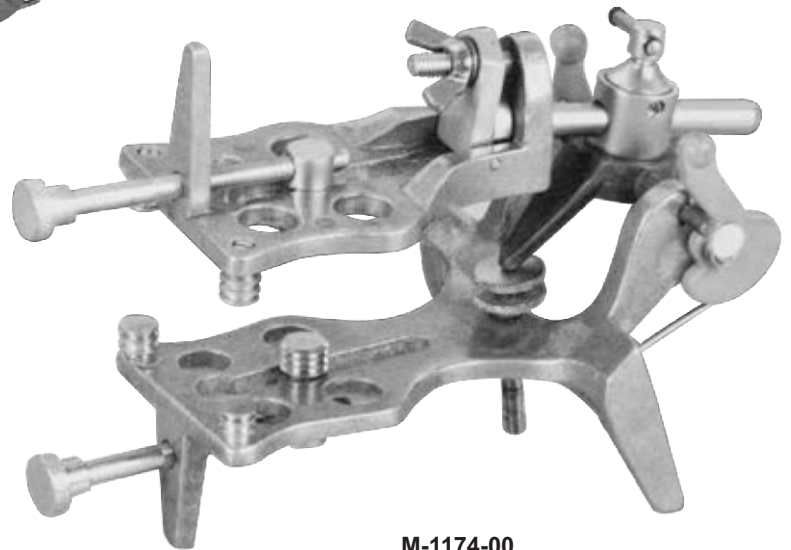

M-1174-00
High Tech Plasteriess Articulator
with Adjustable screws at Rears &
Front All anatomical Movement Possible
Also Available in Vibratory polished.



M-1175-00



M-1176-00

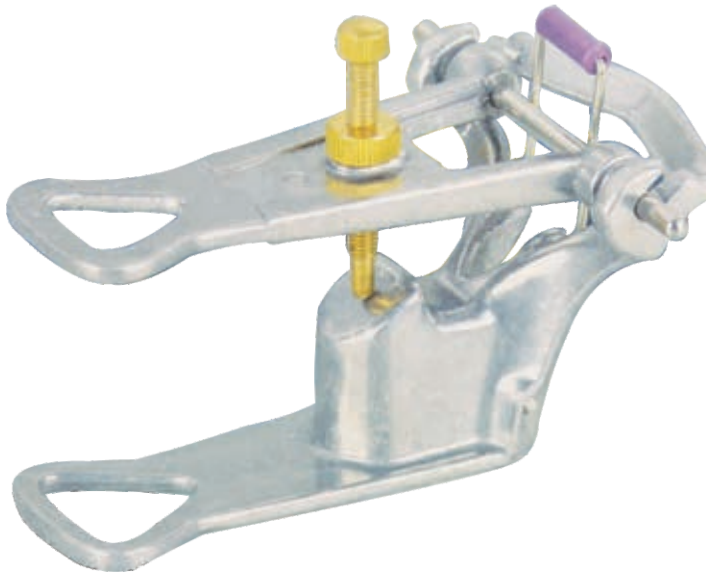

M-1177-00
Professional Occlusor, Vibratory
Polished Articulator



M-1178-00
Professional Occlusor, Vibratory
Polished Articulator



M-1179-00



M-1180-00
Crown & Bridge Articulator

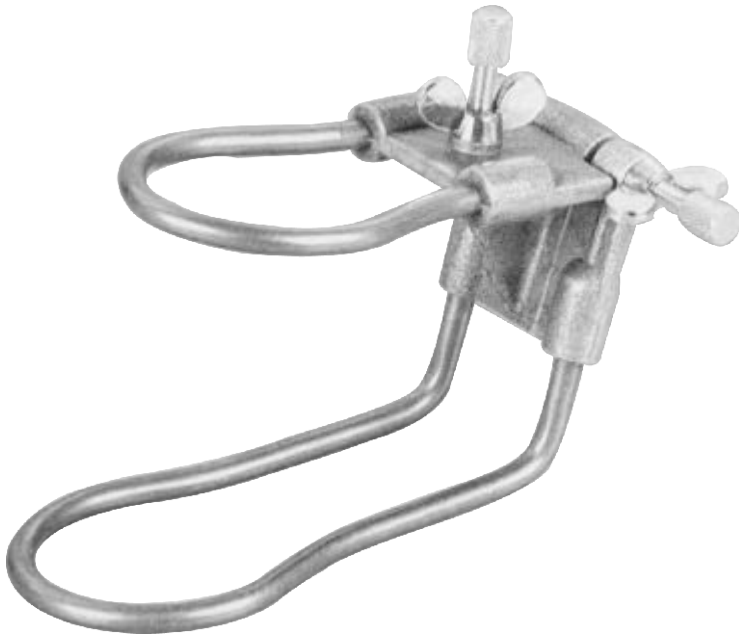

M-1181-00
Vibratory Polished wire Articulator
Made of Stainless Steel & Die Cast Aluminum



M-1182-00
Articulator
Chromium Plated



M-1183-00
Articulator
Chromium Plated



M-1184-00
Articulator 3-Slot
Chromium Plated



M-1185-00

Mortimer-II Oculader Articulator
Plainline Ball Bearing Mortimer-I Oculader
Articulator Serri adjustable Articulator Allows
The Establishment of more Accurate or
Customised Lateral & Pretrusive As Well as
Centric Occlusion. Also Available in Gold Plated



M-1186-00

Mortimer-II Oculader Articulator
Plainline Ball Bearing Mortimer-I Oculader
Articulator All Filled with High Carbon Steel
Balls for smooth setting & Articulation of
Denture. Also Available in Gold Plated.



M-1187-00

Mortimer-II Oculader Articulator
Plainline Ball Bearing Mortimer-I Oculader
Articulator All Filled with High Carbon Steel
Balls for smooth setting & Articulation of
Denture. Also Available in Gold Plated.



M-1188-00

For Chromium Plated
Crown & Bridge Articulator



M-1189-00
Bracket Height Gauge
018



M-1190-00
Bracket Height Gauge
022



M-1191-00
Swivel Head
Bracket Height Gauge



M-1192-00
Bracket Height Gauge



M-1196-01
Decimal Caliper
Measuring Range
0-100 mm



M-1196-02
Decimal Caliper
Measuring Range
0-100 mm



M-1186-03
Decimal Caliper
Measuring Range
0-100 mm



M-1196-04
Decimal Caliper
Measuring Range
0-100 mm



M-1196-05
Decimal Caliper
Measuring Range
0-100 mm



M-1196-06
Decimal Caliper
Measuring Range
0-100 mm



M-1193-01
Iwanson Caliper
for Wax



M-1193-02
Iwanson Caliper
for Metal



M-1193-03
Iwanson Caliper
for Wax



M-1194-00
Degree Gauge for Jewelry



M-1195-00
Wide Jaw Lens Gauge Measures
up to 25mm Thick Lenses in
 $\frac{1}{5}$ mm Graduation 7 $\frac{1}{2}$ " Long

M-1197-00

Wide Throat Lens thickness
Gauge Accomodates Lens
Blanks of over 90mm Diameter
& 22mm in thickness 47mm
Throat Depth, 0.1 mm Graduations
overall Length 9.3/4"

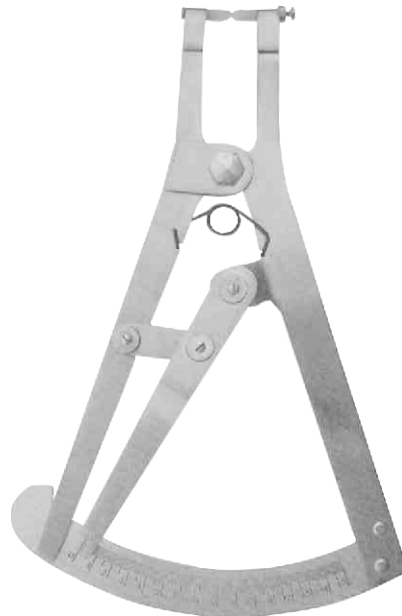
M-1198-00

Lens Thickness Gauge Measuring
up to 25mm Thick Lenses in 1/5mm
Graduations, 7 1/2" Long

M-1199-00

Wide Mouth Lens Gauge
Measuring up to 25mm
Thick Lenses in 1/5mm
Graduations 7 1/2" Long

M-1200-00

Small Mouth / Jaw Lens Gauge
Measuring up to 25mm thick
Lenses in 1/5mm
Graduations, 7 1/2" Long

M-1201-00

Finger Endo Ruler -Sliding

M-1202-00

Finger Endo Ruler- Sliding

M-1203-00

Wide Gauge Popular Gauge
for Gauging Iron wire Hot
& Cold Rolled Sheet Steel



M-1204-01
Orthodontic Caliper
Beerendonk D/E Both side
Graduation 0.8mm Scale



M-1204-02
Orthodontic Caliper
Beerendonk S/E Both side
Graduation 0.8mm Scale



M-1205-00
Sensory Caliper
Vernier Caliper
with plastic, tip 20cm



M-1206-00
Sensory Caliper
Vernier Caliper
with plastic, tip 10cm



M-1207-00
Finger Goniometer
3 Joint Measuring
Range 180°



M-1208-00
Caroll Pocket Goniometer
6" Long with 180° Scale
in 5° increments Fixed
Leg Has 5" Linear Scale
Calibrated in Inches &
Centimeter



M-1214-00
Protractor Goniometer
Two opposing 180 Degree
Scales & one 360 Degree
Scale, all marked in 1 Degree
Increments, Tension Between
Arms controlled by a thumb
Knob. 14" (35cm) Long

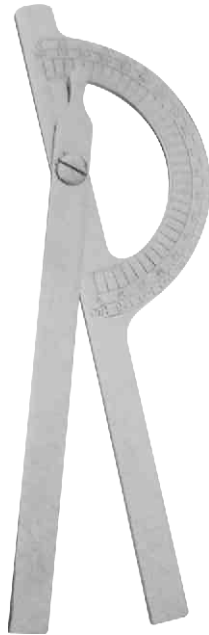

M-1215-00
Finger Goniometer 180°
Two 180° scale in opposing
direction for convenient
reading of all angles. Nickel
chromium plated



M-1216-00
Collin's Pelvimeter for
Measuring angles,
Diameters & Body
Cavities 340mm, 13 1/2"
35cm



M-1217-00
Goniometer -Thole
Measuring of angles,
Diameters & Body
Cavities 340mm, 13 1/2"



M-1218-00
Goniometer Moltgen
Measuring Range
0.180mm



M-1219-00
Endo File Holder



M-1220-01
Eggen Holders Left



M-1220-02
Eggen Holders Straight



M-1220-03
Eggen Holders Right

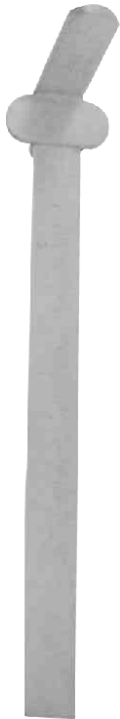

M-1209-00
Wills Bit Gauge Scale
0.100mm Both side
Graduation



M-1210-00
Wills Bit Gauge Scale
0.40mm



M-1211-00
Jaguar Caliper Measuring
Range 0.100mm (3.1/4)
Measures in Millimeters
& Inches



M-1212-00
Townley Caliper Measuring
Range 0.100mm Measures
in Millimeters & Inches



M-1213-00
Jemeson Caliper Measuring
Range 0.90mm Measures
in Millimeters & Inches



M-1221-01

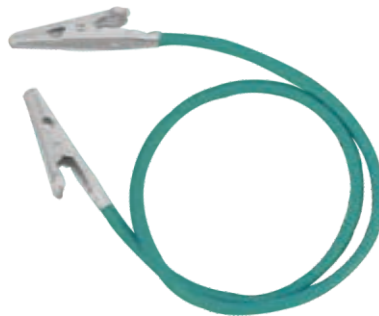

M-1221-02



M-1221-03



M-12212-04



M-1221-05



M-1221-06

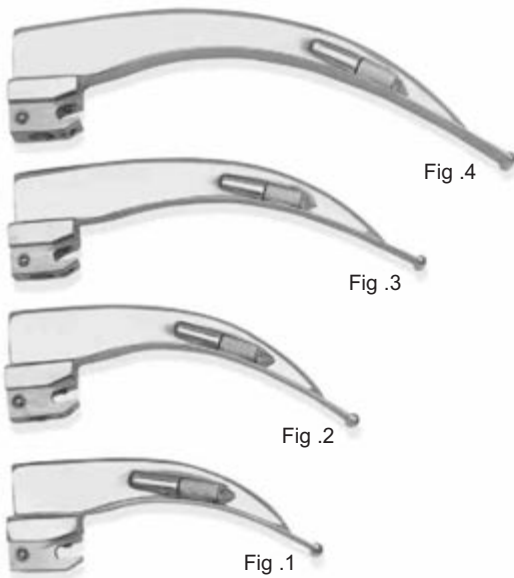

M-1222-00
Conventional Laryngoscope
Battery Handle 11.5 cm
Mackintosh 02,03 & 04
Miller Blade 0.2

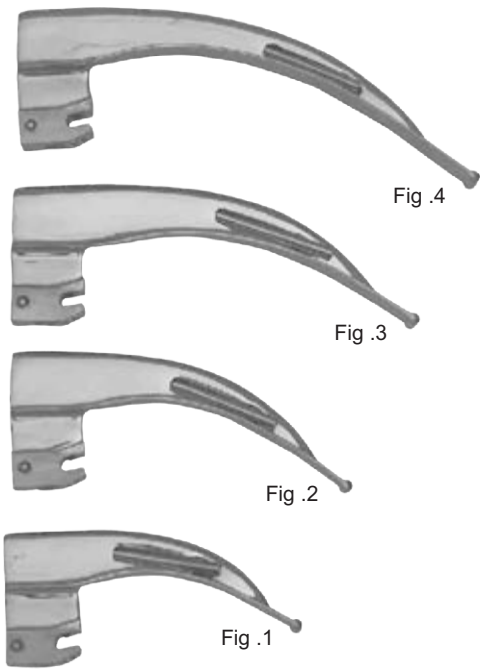

M-1223-00
Fiber Optic Laryngoscope
Battery Handle 11.5 cm
Mackintosh 02,03 & 04
Miller Blade 0.2

M-1224-00
Conventional Laryngoscope
Battery Handle 11.5 cm
Mackintosh Blades 02,03, 04,05



M-1225-00
Fiber Optic Laryngoscope
Battery Handle 11.5 cm
Mackintosh Blades 01,02, 03,04

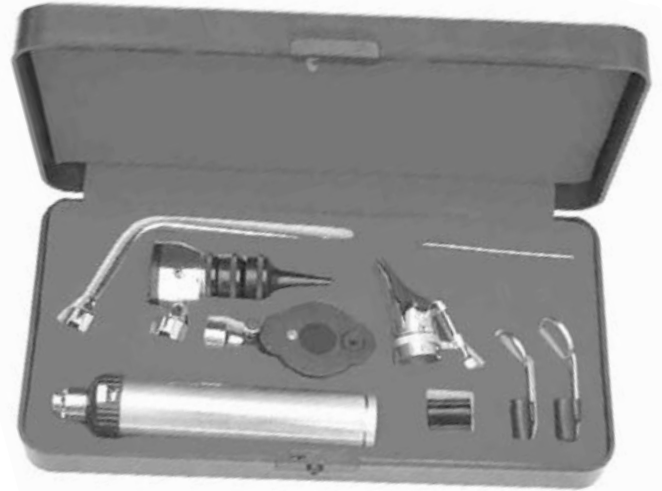

M-1226-00
ENT Set (Screw Lock)
Battery Handle 11.5 cm, Otoscope Head with Three Ear specula, Nasal speculum, Light carrier, 2 Laryngeal Mirrors No 3 & 4 illuminated Tongue Blade holder, Ophthalmoscope 10 Reusable specula.



M-1227-00
ENT Set (Luer Lock)
Battery Handle 11.5 cm, Otoscope Head with Three Ear specula, Nasal speculum, Light carrier, 2 Laryngeal Mirrors No 3 & 4 illuminated Tongue Blade holder, Ophthalmoscope

Hammer Set with Case

Brass (chrome plated)

- Buck
- Taylor
- Babinsky
- Dejerine
- Berliner



M-1228-00



M-1229-00
Otoscope Set with
Ophthalmoscope
Battery Handle, 11.5 cm
Type AA Focussing Device
with Three Reusable Specula



M-1230-00
Otoscope Set (Luer Lock)
Battery Handle, 11.5 cm
One Otoscope Head Luer Lock,
Three Ear Cannula, One spare Bulb



Fig. 04



Fig. 03



Fig. 02



Fig. 01



Fig. 00



Handle

M-1231-01
Fiber Optic Miller Blades, Also
Available in Conventional Miller Blades

M-1231-02
Mini Fiber Optic Otoscope
Fiber Optic and illumination
Robust plastic, Metal connector,
Plastic Tube containing 7 Reusable
Specula, Available colors, Red, Yellow
Black, Blue, Green, Pink & Grey





M-1232-01
Mini Otoscope



M-1232-02
Mini Otoscope



M-1232-03
Mini Otoscope



M-1232-04
Mini Otoscope

Available in colour



M-1232-05
Mini Otoscope with
Pouch

Diagnose-Sets Diagnostic Sets



M-1222-00

Clar Head Light Traditional Head Light 6 Volt, with adjustable joint, Black Plastic Head Bend, with foam rubber & 9 Volts Re-chargeable Battery Along-with Charger, head Bend is Available in assorted Colors

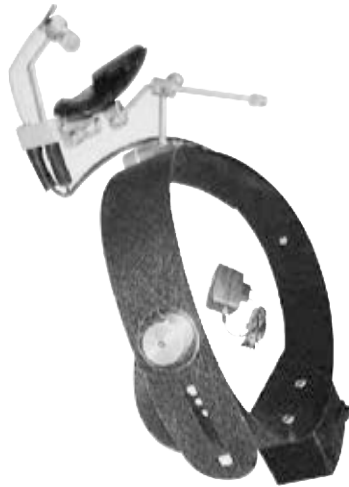

M-1234-00

Lead Free Clar Head Light 9 Volt, with Adjustable joint, Black Plastic Head Bend, with foam rubber & 9 Volts Re-Chargeable Battery along with charger. Head Bend is Available in assorted Colors



M-1235-00

Conventional Jansen Head Light with Standard illumination 2.5V, Chrome plated Head with Magnifying Glass, Movable in all Direction by means of a Joint, Head Bend can be Adjustable by Metal screw. supplied with adaptor. Head Bend is Available in assorted colors



M-1236-00

Lead Free jansen Head Light 9 Volts, Re-Chargeable Battery along-with charger & standard illumination 2.5v, Chrome plated Head with Magnifying Glass. Movable in all Directions by means of a Joint. Head bend can be adjustable by metal screw head bend is Available in assorted colors



M-1237-00

Rexine Head Light 6 Volt, with adaptor 220-224 Volts. The Black Rexine Head bend can be adjusted to the individual Head size by means of Metal Buckle. The Hinge allows adjustment of the bulb in all Directions



M-1238-00

Laser Head Light with Adjustable Joint, Grey Plastic Head bend, with foam rubber. Head bend is Available in assorted colors



M-1239-00

Ziegler Head Mirror The Black Plastic head bend can be adjusted to the individual head size by Means of the Metal Buckle. The Hinge allows adjustment of the Mirror, mm 90, in all Direction. Head bend is Available in assorted colors

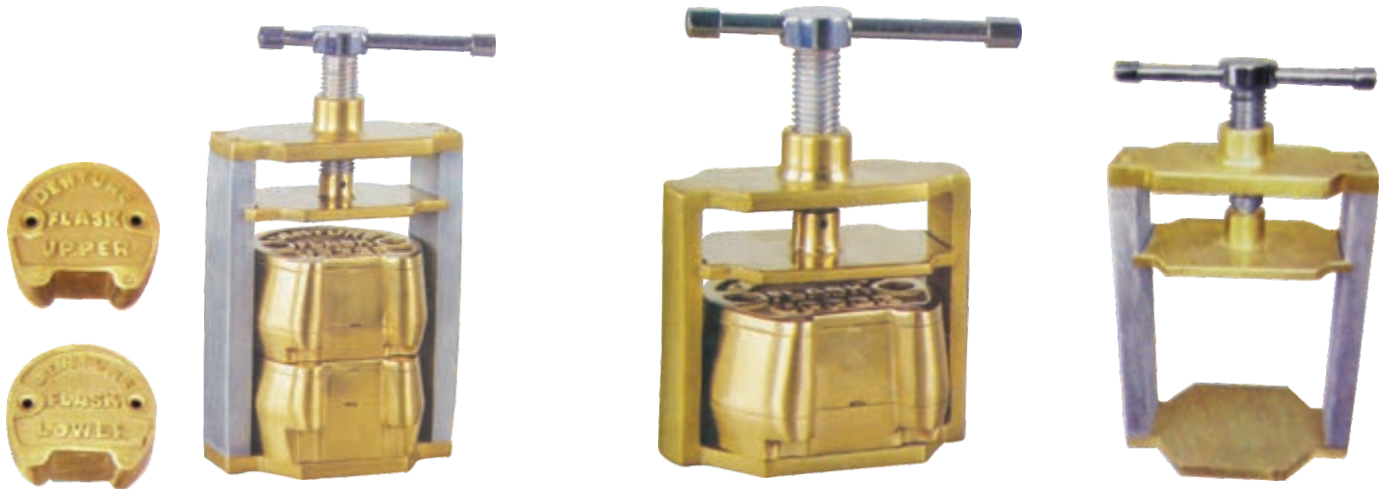
M-1240-00

Upper / Lower Denture Flask & Bench Press
Denture Flask Set featur forged Brass alloy
Construction. Fitted with Hardened stainless steel
alloy Rear Tapered Guide pins. Flask Dimensions:
Long x 3³/₄"Wide x 2¹/₄"High
(10cm x 10cm x 6cm) Unit wweight: 3.850kg including
(upper / Lower Flask & Bench press)

M-1241-00

Small Denture Flask & Bench Press
Denture Flask Set featur forged Brass alloy
Construction. Fitted with Hardened stainless steel
alloy Rear Tapered Guide pins. Flask Dimensions:
4"Long x 3³/₄"Wide x 2¹/₄"High
(10cm x 10cm x 6cm) Unit wweight: 2.425kg including
(Flask & Bench press)

M-1242-00

Flat Bench Press for 2 Denture
Flasks (upper + lower).
Dimension: 20 x 12.7 x 8cm &
Unit weieht is 2.17kg

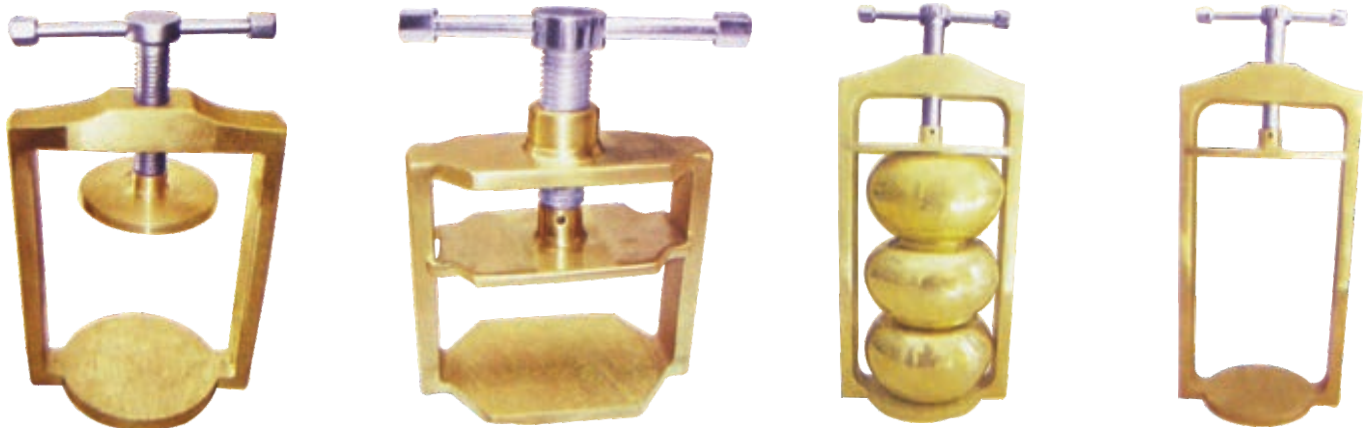
M-1243-00

Alloy Brass Round Bench Press
for 2 Flask. Dimension: 7"x5"x 3¹/₂"
& Unit Weight 1.900kg

M-1244-00

Small Denture Bench Press
for single Flask. Brass
Alloy Construction.
Dimension: 5"x 3"x 4³/₄"
& Unit Weight 1.500kg

M-1245-00

Large Denture Flask &
Bench Press. Alloy Construction
Dimension: Flask Dimension:
5"x 3¹/₂"x 2¹/₂"
& Weight 1.100kg Each
Unit weight 5.750kg
Icluding (3 Flasks & Bench Press)

M-1246-00

Large Bench Press for
3 Flasks. Featured forged
Brass Alloy construction.
Dimension: 29 x 14 x 9cm
Unit weight: weight 2.800kg



M-1247-00
Round Denture Flask
are made in superior
Gunmetal & Brass
The round Flasks are Appropriate
Dimension: 4" x 4 1/2" x 2 1/2" and
Weight 1.100kg



M-1248-00
Crown Flask for Dental Tooth,
Forged Brass Alloy construction
Unit weight: 365 gram



M-1249-00
One Side Flat Brass Flask.
New Shape forged brass
Alloy construction.
Dimension: 2 1/4" x 3 1/2" x 4 3/4"
& Unit weight 955 gram



M-1250-00
Mortimer Silverline Alloy Flask.
Forged Silver Alloy construction.
Dimension: 4 1/4" Long x 4"
Wide x 2 3/4" High (11 x 10 x 7cm)
Unit weight = 750 gram

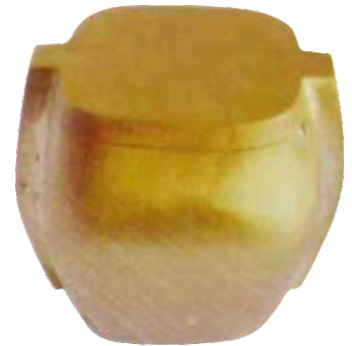

M-1251-00
Forged Brass Toothed
Dental Alloy Flask for
Single tooth.
Dimension: 5.0 x 5.0 x
4.0cm &
Unit weight 270gram



M-1252-00
Square Dental Alloy Flask.
Pressure Die Casted, made of brass
Dimension: 7.2 x 8.4 x 5.0 cm
Unit weight 1.300kg



M-1253-00
Upper Denture Flask forged
Brass Alloy construction.Fitted
with Hardened stainless steel
Alloy rear Tapered guide pin.
Dimension: 4" Long x 3 3/4"
wide x 2 1/4" High (10cm x 10cm x 6cm)
& weight: 0.920kg



M-1254-00
Lower Denture Flask forged
Brass Alloy construction.Fitted
with Hardened stainless steel
Alloy rear Tapered guide pins.
Dimension: 4" Long x 3 3/4"
wide x 2 1/4" High (10cm x 10cm x 6cm)
& weight: 0.920kg



M-1261-00
Gic Applicator



M-1262-00
Gic Activator



M-1255-00

Upper Denture Flask forged Silver Alloy construction. Fitted with Hardened stainless steel Alloy rear Tapered guide pins.
Dimension: 4" Long x 3 3/4" wide x 2 1/4" High (10cm x 10cm x 6cm)



M-1256-00

Lower Denture Flask forged Silver Alloy construction. Fitted with Hardened stainless steel Alloy rear Tapered guide pins.
Dimension: 4" Long x 3 3/4" wide x 2 1/4" High (10cm x 10cm x 6cm)



M-1257-00

Upper / Lower Hanau Denture Flask. forged Brass Alloy Construction. Fitted with Hardened stainless steel Alloy rear Tapered guide pins.
Dimension: 10 x 8 x 16 cm wide x 2 1/4" Long x 3 3/4"



M-1258-00

Silverline Alloy Flask. forged Silver Alloy construction,
Dimension: 4 1/4" Long x 4" wide x 2 3/4" High (11 x 10 x 7cm)
Unit weight = 760 gram

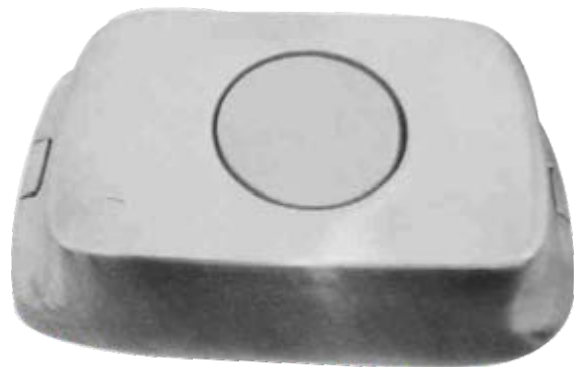

M-1259-00

Butter Dish Silver Alloy Denture Flask.
Dimension: 10 x 8 x 16 cm
Unit weight = 760 gram



M-1260-00

Flask Knock-out Disc Forged Brass Alloy construction



M-1263-01
Corn Cutter



M-1263-02
Corn Cutter - Plastic Handle



M-1263-03
Corn Cutter - Plastic Handle



M-1263-04
Corn Cutter - Plastic Handle



M-1264-00
Universal Bur
Changer Wrech



M-1265-00
Dentalire Bur
Changer wrench



M-1266-00
Pocket Instruments
Holder



M-1267-00
Bow Caliper 8
(compasse)



M-1268-00
Diamond Disc Guard
with adapter



M-1269-00
Caliper Eight Gauge

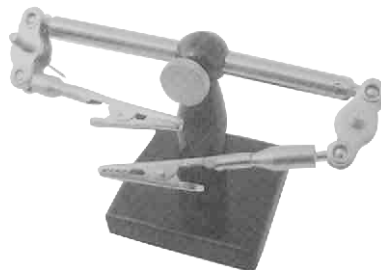

M-1270-00
Optical Inspection stand



M-1271-00
Matrix Retainer Eliote
Separator



M-1272-00
Gem Holder
Bead Holder



M-1273-00
Tongue Depressor
Small, Large



M-1274-00
Ring Bending Pliers
Swiss Model 190 mm



M-1275-00
Mesh Bur Holder



M-1276-00
Stripholder Clips



M-1277-00
X-Ray Film
Holder



M-1278-00
Radiography Clip



M-1279-00
X-Ray Film hangers Multiple Clips
Available in 6, 8, 10, 12, & 14 Clips



M-1280-00
Feline Mouth Gag for
cats with Nylon Inserts
Available in 2 sizes
Small 2.5" Large 3"



M-1281-00
Canine Spring Action
Mouth Gag with Nylon Inserts
Available in 3 Sizes Small 4.5"
Medium 5.28" - Large 7"

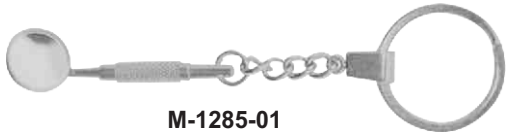

M-1285-01
Mouth Mirror Keychains



M-1285-02
Mouth Mirror Keychains



M-1285-03
Mouth Mirror Keychains



M-1285-04
Mouth Mirror Keychains



M-1285-05
Tweezer Keychains



M-1285-06
Dental Tooth Keychains



M-1285-07
Extracting Forceps Keychains



M-1285-08
Dental Caliper Keychains



M-1285-09

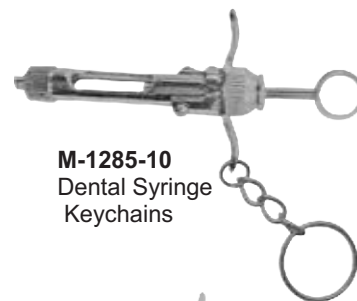

M-1285-10
Dental Syringe
Keychains



M-1285-11
Dental Syringe
Keychains



M-1285-12
Impression Tray Keychains



M-1290-01
Dental Forceps Set
Childs



M-1290-04
Dental Forceps Set



M-1290-02
Rubber Dam Set



M-1290-05



M-1290-06



M-1290-03
Rubber Dam Set



M-1290-07
Root Elevator Set



M-1291-01



M-1291-02



M-1291-03



M-1291-04



M-1291-05



M-1291-06



M-1291-07



M-1291-08

A

ABOTT , Scalers	179
ADAMS , Wire Bending Pliers	239
ADERER , Wire and Clasp Bending Pliers	241
ADSON , Bone Rongeurs	98
ADSON , forceps	110-119
AINSWORTH , Rubber Dam Punch Forceps	134
ALBRECHT , Tooth Extracting Pliers	47
ALEXANDER , Chisels and Gouges	122
ALLIS , Hemostatic Forceps	93
AMSTERDAM Tissue forceps	107
Amalgam Carriers	158-159
Amalgam Condensers	137-141
Amalgam Wells	111
ANGLE , Wire Bending Pliers	238-239-243
ANDERSEN Orthodontic pliers	242
APICAL , Root Elevators	53, 55, 65
ARRINGTON , Amalgam Condensers	194
ARRUGA Needle holder	87
ARTHUR , Splinter Forceps	48
ARTICULATORS	279 to 285
ASH , Filling Instruments	206

B

BAADE , Copper Ring Removing Pliers	244
BABY-CRILE-WOOD , Needle Holders	85
BACKHAUS , Towel Clamps	94
Band Forming Pliers	174
Band Pushers	151
BANE , Bone Rongeurs	98
BARRY , Root Elevators	69
BARRAQUER Needle holder	83
BAUMGARTNER , Needle Holders	81-84
BAYLOR , Scalers	185
BEEBEE , Crown Scissors	77
BEIN , Root Elevators	49-50-51-52
BENNETT , Filling Instruments	206
BERNARD , Root Elevators	62
BEYER , Bone Rongeurs	100
BISHOP , Chisels and Gouges	122
Black , Scalers	179 , 185 , 189-190-191
BLACK (HAUBEIL) , Amalgam Condensers	192
BLACK , Amalgam Condensers	137
BLACK , Cavity Preparation Instruments	232
BLACK , Enamel Instruments	135-136
BLUMENTHAL , Bone Rongeurs	95
BOHM , Telescope Crown Pliers	244
Bone Curettes	87
Bone Files	86
Bone Rongeurs	72-77
BOSWORTH , Tongue Depressors	128
Boynton Needle holders	82-88
BRACKET HEIGHT GAUGE	286
BREWER , Rubber Dam Clamp Forceps	133
Brom-Allen	47
BRUENINGS , Tongue Spatulas	128
BUCHWALD , Tongue Spatulas	92
BUSCH Extracting forceps	24
BUCK , Gingivectomy Knives	231
BUCKLEY , Gouges	163
BUCKLEY , Periodontia Inst	229

C

CALIFORNIA , Scalers	177
Carving Instrument	216-217-218-220
CASTROVIEJO , Micro Scissors	79-80
CASTROVIEJO , Needle Holders	90-91
CASTROVIEJO-BARRAQUER , Needle Holders	83-90

CASTROVIEJO-MICRO , Needle Holders	83
CATTONI , Periodontal Pocket Probes	161
CAWOOD-MINNESOTA , Lip and Cheek Retractors	127
Cement Spatulas	221
CHEATLE , Sterilizing Forceps	260
Check Bite	181
CHIP BLOWERS	156
Cheek Retractor	90-91
Chisels and Gouges	85-86
CHOMPRET , Root Elevators	64
CLEVELAND , Bone Rongeurs	97
CLEVELAND , Scalers	181
CLEVELAND-GARDNER , Bone Rongeurs	99
Cleoids Discoids Amalgam carver	198-199-212
COHAN Extracting forceps	33
COLEMAN , Root Elevators	63
COLLEGE , Dental Pliers	101-102-103-105-119
COLLIER , Needle Holders	81
COLLIN , Tongue Holding Forceps	129
COMPOSIT Inst	196-197-222
CON SCODELLINE , Wax Knives	177
CONDENSER Endodontic Ins	164
Cotton Roll Holder	92
Cotton Wool Roll Holder	271
COUPLAND , Root Elevators	57
CRANE PICK , Root Elevators	53
CRANE-KAPLAN Tissue forceps	108
CRILE-WOOD , Needle Holders	85
Crown Instruments	147-148-149-150-151
CRYER , Extracting Forceps	34
CRYER , Root Elevators	53-54-57
CARTRIDGE Syringes	152-153-154-155
CUMINE , Scalers	186
Curettes	87, 131-132, 160-162
CUSHING , Scalers	182
CUSHING , Dental pliers	119

D

DARBY-PERRY , Excavators	172-173
DAVIS , Sterilizing Forceps	260
DE LA ROSE Orthodontic pliers	247
DEBAKEY , Needle holder	87
DEBAKEY , Tissue forceps	76
DEAN , Gum Scissors	108
DENHART , Mouth Gags	130
Dental Pliers for Nerve Needles	82
Dental Pocket Markers	83
DENTURE ALLOY FLASK & PRESS	301 to 303
DENTAL Pliers	103-104-106-118
DENTAL Instruments	304
DETACHABLE , Mouth Gags	94
DIAGNOSTIC INSTRUMENTS	294 to 300
DISCOIDE Filling Inst	211
DISTAL CUTTER	248
DIETRICH , Needle holder	89
DIEFFENBACH , Operating Knives	141
DIVARICATORE LABIALE , Lip and Cheek Retractors	91
DRESSING Forceps	109-110-114-115
DOYEN-COLLIN	130
DOYEN-JANSEN	130

E

EDNA(LORNA) , Towel Clamps	94
EGGEN HOLDER	292
ELLIOT , Separators	100
ELLIOT , Filling Instruments	206
ENDODONTIC BOXES	272
Enamel Instruments	135-136



E

Endodontic Instruments	167
ENDO FILE HOLDER	292
ERMERT , Wax Knives	253
Excavators	212-174
Extracting Forceps	1-48

F

FAHNENSTOCK , Wax Knives	253
FARABEUF , Lip and Cheek Retractors	127
FERGUSSON-ACKLAND Mouth Gage	130
FEHR , Scalers	182-186
FELSCH , Extracting Forceps	16
FEILCHENFEID Forceps	117
Filling Instruments	200-204-207-208-209-210-211-212
Finger Protectors	94
FISCHER Orthodontic pliers	237
FLAGG , Dental Pliers	101-105
FLOHR , Root Elevators	53-54, 65
FRAHM Amalgam carver	199
Forceps	78-84
FOX , Gum and Tissue Forceps	117
FREER , Periosteal	230
FREVERT , Orthodontic Pliers	240
FRIEDMANN , Bone Rongeurs	96-98
FRIEDMANN-GRAZIL , Bone Rongeurs	75
FRIEDMANN (Fergusson)	157
FURRER , Cooper Ring Remover Pliers	244-173

G

GARDNER , Bone Chisels	163
GARDNER , Chisels and Gouges	85-229
GETHRO , Scalers	185
GERALD Dressing forcps	112
GILLET , Excavators	123
GLICK Amalgam carver	199
GILLIES , Needle Holders	85
GILLIES-SLIM , Needle Holders	85
Gingivectomy Knives	165-166
GLOBE , Scalers	186
GOLDMAN-FOX , Cavity Preparation Instruments	232
GOLDMAN-FOX , Combination Explorers-Probes	162-163
GOLDMAN-FOX , Gingivectomy Knives	165
GOLDMAN-FOX , Gum Scissors	74-76
GOLDMAN-FOX , Periodontal Pocket Probes	160-161
GOLDMAN-FOX , Periosteal	230-231
GORDON , Orthodontic Pliers	240
GOSLEE , Orthodontic Pliers	240
Gracey curttes	223-224-225-228
GRITMAN , Carving Instruments	214
GRITMAN , Plaster Knives	254
GRACILE , Dressing forceps	110
Gum and Tissue Forceps	78
GUY , Tongue Holding Forceps	129
GUY , Scalers	182
GUENTHER Scalers	186

H

HALSEY , Needle Holders	81-84
HALSTED-MOSQUITO , Hemostatic Forceps	70
HANDLES	175-176
HARTMANN , Bone Rongeurs	95
HAUBEIL , Scalers	185
HEGAR-BAUMGARTNER Needle holder	86
HEIDBRINK , Root Elevators	71-72
HEIDEMMAN Filling Inst	210
HEISTER , Mouth Gags	131
HEMINGWAY , Bone Curettes	123

Halsted-Mosquito Hemostatic Forceps	93
HERTZ Extracting forceps	25
HILGER , Mouth Mirrors	146
HOLLENBACK , Amalgam Condensers	193
HOLLENBACK , Periodontal Instruments	231
HOLLOWARE Inst	268 to 271
HOW , Crown Collar Pliers	244
Hopp-Schiedel Needle holder	89
HULL Extracting forceps	33
HUNTER Splinter forceps	117
HYGIENIST , Scalers	181
HYLIN , Carving Instruments	215
HYLIN , Root Elevators	61
HYLIN-CERAMICA , Carving Instruments	155
HYLIN-SCRED , Carving Instruments	155
HYLIN-LE CRON , Carving Instruments	155

I

Implants Surgery	233-234
Impression Trays	273 to 278
Sterilization Trays	262-267
IODINE CUP	270
IRIS , Scissors	74-75
IVORY , Matrix Retainers	139-140
IVORY , Rubber Dam Clamp Forceps	133-135
IVORY , Amalgam Carries	159
IVORY , Rubber Dam Punch Forceps	96
IVORY , Separators	100

J

JANSEN , Bone Rongeurs	98
JELENKO Orthodontic pliers	242
JOHNSON Orthodontic pliers	240
JENNINGS , Mouth Gags	131
JOERGENSEN , Amalgam Condensers	195
JONES , Towel Clamps	94
JQUETTE , Scalers	177, 185

K

KELLY , Hemostatic Forceps	93
KELLY , Scissors	74
KIDNEY TRAY	271
KIRK , Dentimeters	151
KIRKLAND , Scalers and Gingivectomy Knives	184
KIRKLAND , Gingivectomy Knives	232
KOCHER , Retractors	124
KOCHER , Hemostatic Forceps	93
KOPP , Medicament Carrier Forceps	83
KOPP , Root Elevators	59-60
KOPP , Dental Pliers	118
KRALLENHEBER , Root Elevators	66

L

LADMORE , Filling Instruments	201
LADMORE , Gum Forceps	81
La Grange Scissor	74
LANGE , Probes and Explorers	171
LANGENBECK , Retractors	14
LANGENBECK , Finger Protectors	131
LANGENBECK , Needle Holders	82-88
LECLUSE , Root Elevators	67
LE-CRON , Carving Instruments	214, 216
LESSMANN , Wax Knives	253
Lichtenberg , Needle holder	88

LICHTENSTEIN , Plaster Spatulas	255
LIGATURE CUTTER	248
LINDO-LEVIEN , Root Elevators	61-62
Lip Retractors	90-91
LISTER , Bandage Scissors	78
LISTON , Bone Rongeurs	100
LITTAUER , Stitch Scissors	62
LOCKLIN , Gum Scissors	76
LONDON-COLLEGE , Dental Forceps	79-80
LOTION BOWL	270
LUCAS , Bone Curettes	123
LUCAS , Chisels and Gouges	121
LUER , Bone Rongeurs	96-99
LUKS , Endodontic Instruments	164
LUNIATACHEK Retractor and tongue	128

M

Maillets	163
MALOTTKY , Orthodontic Pliers	241
MARTIN-NORTHBENT , Scissors	78
MARTIN , Needle holders	86
MATHIEU , Needle holders	88
MATHIEU-KOCHER , Needle Holders	82-88-89
Matrix Bands	99-100
Matrix Retainers	99-100
MAYO-HEGAR , Needle Holders	82-84-87
MC CALL , Scalars and Periodontal Curettes	183
MC KALLOPS , Wire and Clasp Bending Pliers	241
McIvor Mouth Gags	132
McIndoe Dressing forceps	110
MEAD , Bone Rongeurs	96
MEAD , Extracting Forceps	15-16
MEAD , Mallets	163
MEAD , Periodontia inst	229
MEAD , Root Elevators	70
MEASURING Instruments	287 to 292
Medicament Carrier Forceps	83
MEDICINE CUP	270
MERIAM , Dental Pliers	101-102-105-107-119
MERRITE , Periodontal Pocket Probes	160
MERSHON , Band Pusher	108
METZENBAUM , Operating and Dissecting Scissors	74-78
MIDDELDORPF , Retractors	124
MILLER , Articulators Paper Forceps	108
MILLER , Bone Files	122, 163
MILLER , Periodontia Inst	229
MILLER , Root Elevators	54
Milwaukee Extracting forceps	26
Mirrors Handle	103-104
Mirrors	105
MITCHELL , Scalars	134
MOD.BERLIN , Filling Instruments	202
MOD.Martin	111-116
Modelling Instruments	154-158-260
MOLT , Mouth Gags	130
MOLT , Periosteal	230
MONTFORT , Crown Slitter	244, 173
MORE , Scalars	181
MORTONSEN , Filling Instruments	200
Mouth Gags	94
Mouth Mirrors & Handles	143-144-145-146
MUEHLEMANN , Curettes	132
MUEHLEMANN , Scalars	181, 184, 133
MIX INSTRUMENTS	305-306

N

NABERS , Periodontal Pocket Probes	161
NANCE Orthodontic pliers	242
Needle Holders Kit	92
NAPKIN HOLDERS	293
NEUMANN , Scissors	75
Noyes Scissors	79
NYSTROM , Matrix Retainers	139

O

OCHSENBEIN , Periodontia Inst	229
OLSEN-HEGAR , Needle Holders	85
OLIVER Orthodontic pliers	238
Operating Knives	101
ORBAN , Gingivectomy Knives	232
ORIGINAL BUFFALO , Plaster Knives	254
ORIGER Retractor	126
Orthodontic Pliers	235 to 252
OTT , Root Elevators	63
OUNCES	270

P

PALMER , Rubber Dam Clamp Forceps	133
PARKER , Operating Knives	141
PARTSCH , Chisels and Gouges	229
PEAN , Hemostatic Forceps	93
PEESO , Crown Collar Pliers	243
Periodontal Curettes	226-227, 228-162
Periodontal Instruments	229-132, 160-166
Periodontal Pocket Probes	112-113
Periodontal Pocket Probes	112-113
PROBES & EXPLORERS	168-169-170-171
PERRY , Dental Pliers	101
PK THOMAS , Carving Instruments	158
Plaster Knives and Spatulas	178-179
Plaster Shears	256
Polishing Instruments	153
POTT , Root Elevators	49
PPBUSER , Periodontal Instruments	164
PK THOMAS Carving inst	218-219
PRICHARD , Periosteal	230
Porte-curettes	112-115, 118-126
Porte-empreintes	181-182
Porte-matrices	99-100
POTT , Elevator	64
POTT-Smith Needle holder	89
POTT-Smith Dressing forceps	112-119
Pousse rubans	108
PPBUSER , Instruments pour la parodontologie	230
Pforateurs a crampons	96

Q

QUINBY , Scissors	75
--------------------------	----

R

RALKS , Splinter Forceps	48
RAYNOLDS Orthodontic pliers	240
READ , Root Elevators	48
Retactors	88-89
ROACH , Carving Instruments	214
ROCHESTER-PEAN , Hemostatic Forceps	93
ROGGE , Sterilizing Forceps	260
Root Elevators	34-57
Root Pin Pliers	81
Root Splinter Forceps	32-33
ROSER KONIG , Mouth Gags	130



Roeder Towel Clamp	94
Rubber Dam Clamps	136-137-138-98
Rubber Dam Frame	96
Rubber Dam Instruments	95-98
Rubber Dam Punch Forceps	96
RUSKIN , Bone Rongeurs	100
RYDER , (FRENCH EYE)	67

S

SAROT Needle holder	86
SALIVA Ejectors	157
Scalers & Scaler Kit	187-188
SACRED Carving Inst	215
Scalpels, Knives Handle	142
SCHAEDEL , Towel Clamps	94
SCHARMANN , Scalers	180
SCHLEMMER , Root Elevators	58
SCHWARZ , Arch and Spring Bending Pliers	246
SCHWARZ , Arrow Head Clasp Bending Pliers	172
SCHWARZ , Wire and Clasp Bending Pliers	239
Scissors	77-78
SELDIN , Bone Files	122
SELDIN , Root Elevators	53-54, 56-41
SEMKEN Dressing forceps	113-119
SENN-MUELLER , Retractors	124
Spreader Endodontic Ins	165
SEPTUM LANCETS , Root Elevators	66
SIMPLEX Retractor & Tongue depressors	128
SICHEL Scalers	177
SKYP-JECT , Syringes	109
SMITH , Scalers	125
Soldering Tweezers	84
SPITTEN MUG	270
SPENCER , Stitch Scissors	78
Splinter Forceps	78
STANDARD , Operating Scissors	62
Sterilizing Forceps	261
STERNBERG , Lip and Cheek Retractors	127
STIEGLITZ , Splinter Forceps	48
STIEGLITZ , Orthodontic pliers	235
STIKSA , Extracting Forceps	16
STILLE , Dressing forceps	111-116
STOCKES , Rubber Dam Clamp Forceps	133
STUDENT KITS	257-258-259
SUTURE Forceps	120
SUCTION TUBES	157
Syndesmotomes	73
SYRINGES	109

T

TAYLOR , Periodontal Instruments	231
TAYLOR , Dressing forceps	113
Telescopic Crown Pliers	151
THPLEX Orthodontic pliers	245
THORPE , Scalers	177
THUERRIEGEL Endodontic Inst	125
TOBOLD , Tongue Depressors	128
TOENNIS , Needle Holders	166
TOFFLEMIRE , Matrix Retainer	82-88
TOMES , Extracting Forceps	25
TOMPKINS , Scalers	178
Tongue Depressors	92
Tongue Holding Forceps	93
Towel Clamps	71
TOWNER , Scalers	125
TOFFLEMIRE	140
TREYMANN , Crown Remover	150
TRYTUS Orthodontic pliers	240
TWEED Orthodontic pliers	242

U

ULLEVAL STERILIZING FORCEPS	261
UNIVERSAL , Crown Instruments	150
UNIVERSAL , Pin Bending Pliers	245-249
UNIVERSAL , Bone Rongeurs	73
UNIVERSAL , Crown Scissors	77
UNIVERSAL , Needle holders	86
UNIVERSITY OF MICHIGAN , Combination Explorers-Probes	162-163
UNIVERSITY OF MICHIGAN , Periodontal Pocket Probes	160-162
UNIVERSITY OF MINNESOTA Retractor	128
USA MODELL , Contouring Pliers	240
USC Amalgam carver	199
UTILITY , Sterilizing Forceps	71

V

VEHE , Carvong Instruments	214
Vascular , Micro Needle holder	89

W

WALDSACHS , Wire Twister and Ligature Pliers	246
WALDRON Orthodontic pliers	245
WALLIS , Filling Instruments	201
WARD , Amalgam Condensers	194
WARWICK-JAMES , Root Elevators	63
WAX KNIVES	177
WASSMUND , Retractors	124
WEBSTER , Needle Holders	81-84
WESTCOTT , Micro Scissors	79
WESTON , Probes and Explorers	249
WEINGART Pliers	171
WHITE , Excavators	174
WHITE , Polishing Instruments	213
WHITE , Scalers	181, 189
WHITE , Enamel Instruments	135
WHITE , Filling Instruments	202-203
WHITE , Root Elevators	56
WHITE , Rubber Dam Clamp Forceps	133
WHITEHEAD , Mouth Gags	131
WHITESIDE , Scalers	177
WHITTEN , Scalers	177
WIEDER , Tongue Depressors	128-115
WILLIAMS , Combination Explorers-Probes	162-163
WILLIAMS , Filling Instruments	205-206
WILLIAMS , Periodontal Pocket Probes	160
WILLIAMS , Endodontic Ins	166
WILLIGER , Retractors	125, 132
WILLINGER Periodontia inst	229
WILLIGER , Scalers	182
WILAND Amalgam carver	199
WINTER , Root Elevators	68
WISDOM-ROUTURIER , Extracting Forceps	17
WITER , Root Elevators	56
WITZEL , Extracting Forceps	24-47
WOODSON , Filling Instruments	204
Woodward Extracting forceps	26-27
WRIGHT (DREF) , Needle Holders	82-84

Y

YOUNG , Tongue Holding Forceps	129
YOUNG , Wire Bending Pliers	246
YOUNGER , Scalers	125
YOUNGER-GOOD , Scalers	180-185

Z

ZAHLE , Carving Instruments	215
ZERFING , Scalers	177



📞 +92 305 6529284 ✉ info@segitech.net

📍 Defence Road Kareem Plaza Sialkot 51310 Pakistan.

🌐 **www.segitech.net**