



SEGITECH

Surgical Catalogue



1
General Instruments

- Operating knives
- Betriebssystem Messer
- Couteaux d'exploitation
- Cuchillos de funcionamiento

1-18

6
General Instruments

- Retractors
- Retraktoren
- Rétracteurs
- Retractores

137-194

2
General Instruments

- Supercut Scissors
- Ciseaux Supercut
- Ciseaux Supercut
- Tijeras Supercut

19-80

7
General Instruments

- Probes
- Probes
- Sondes
- Sondas

195-200

3
General Instruments

- Dressing Forceps
- Kornzangen
- pinces à pansement
- Pinzas de Vestir

81-100

8
Suture Instruments

- Micro Needle Holders
- Mikronadelhalter
- Porte-aiguilles Micro
- Los titulares de aguja Micro

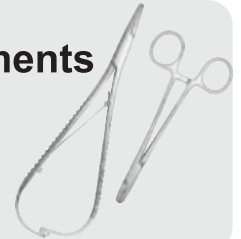
201-240

4
General Instruments

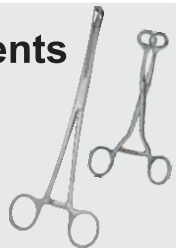
- Bulldog Hemostatic Forcepsg
- Bulldog Hämostatische Forcepsg
- Bulldog Forcepsg hémostatique
- Bulldog hemostático Forcepsg

101-130

9
Diagnostic Instruments

- Sensibility Instruments and Stethoscopes
- Sensibility Instrumente und Stethoskope
- Instruments sensibilité et Stéthoscopes
- Los instrumentos de sensibilidad y Fonendoscopios

241-244

5
General Instruments

- Polypus and Dressing Forceps
- Tupfer und Pinzette
- Polypus et pinces à pansement
- Pólipos y pinzas de Vestir

131-136

10
Anaesthesia Instruments

- Laryngoscopes
- Laryngoskope
- Laryngoscopes
- Laringoscopios

245-257

11

Puncture Instruments

- Trocars
- Trokare
- Trocarts
- Trócares

258-260

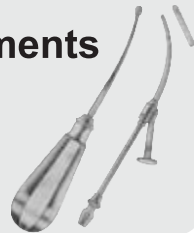

15

Tracheotomy Instruments

- Trachea Dilators and Retractors
- Trachea Dilatoren und Retraktoren
- Dilatateurs trachée et retracteurs
- Tráquea dilatadores y retractores

415-416



12

General Instruments

- Plaster Instruments
- Gips Instruments
- Instruments de plâtre
- Instrumentos de yeso

261-263



16

Goitre Instruments

- Probes, Goitre, Grasping and Muscle Clamps
- Probes, Kropf, Greifen und Muscle Schellen
- Sondes, le goitre, préhension et pinces musculaires
- Las sondas, el bocio, agarrar y abrazaderas musculares

417-417



12

Bone Instruments

- Bone Chisels & Gouges
- Knochenmeißeln & Gouges
- Bone ciseaux et gouges
- Cinceles y Gouges

263-336



17

Dermatology Instruments 418-419

- Lupus Currettes, Scraper, Moncrops Knife and Cutaneous Hooks, Trephines
- Lupus Küretten, Schaber, Messer und Moncrops
- Kutane Haken, Trepane
- Currettes lupus, raclettes, des couteaux et Moncrops
- Crochets cutanées, trépan
- Curetas Lupus, un raspador, cuchillos y Moncrops
- Ganchos cutáneos, trépanos



13

Cardiovascular Instruments

- Rib Shears
- Rib Shears
- Costotome
- Tijeras de costilla

337-389



18

Stomach, Intestine and Rectum Instruments

- Tissue Seizing Forceps and Intestinal Atrauma Tissue Forceps
- Tissue ergriff Pinzetten und Darm Atrauma Pinzette
- Saisir les tissus intestinaux et Pince Forceps tissus atraumatique
- Aprovechando los tejidos Pinzas Pinzas intestinales y tisulares Atrauma

420-443



14

Neuro and Laminectomy Instruments

- Instrumentns for Crenial Opening
- Instrumentns für Crenial Eröffnung
- Instrumentns concernant l'ouverture Crenial
- Instrumentns para la Apertura de Crenial

390-414



19

Kidney, Liver and Gall Stone Instruments

- Kidney Pedicle Clamps Forceps
- Kidney Gestielte Klemmen Pinzetten
- Rein pédiculaires Forceps Pincas
- Pinzas Pinzas renales pediculares

444-458

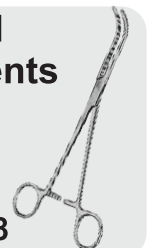

20

Gynecology Instruments

- Vaginal Speculas
- Vaginal Speculas
- Speculas vaginales
- espéculos vaginales

459-491



21

Ophthalmology Instruments

- Eye Speculas
- Eye Speculas
- Speculas Eye
- espéculos de ojos

492-544



22

Obstetrics Instruments

- Pelvimeter, Obstetrics Forceps
- Pelvimeter, Obstetrics Zange
- Pelvimètre, Obstetrics Forceps
- Pelvimetro, Obstetrics Pinzas

545-549

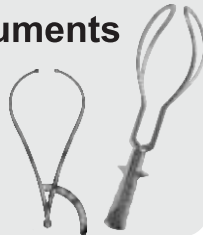

23

Otology Instruments

- Micro Ear Forceps
- Micro Ohrzängchen
- Micro Ear Forceps
- Micro Ear Forceps

550-575



24

Rhinology Instruments

- Nasal Specula
- Nasenspekula
- nasale spéculer
- Espéculo nasal

576-605



25

Oral Maxillo Facial Surgery

- Elevators, Graft Packers
- Aufzüge, Graft Packers
- Ascenseurs, Packers greffon
- Ascensores, Packers injerto

606-644



General Instruments

Scalpel Handles
Skalpellgriffe

Poignées Scalpel
Los mangos de bisturí



Scalpel Handle No. 3
01-0001-03



Scalpel Handle No. 3K
01-0002-03



Scalpel Handle No. 4
01-0003-04



Scalpel Handle No. 4
01-0004-04



Scalpel Handle No. 7
01-0005-07

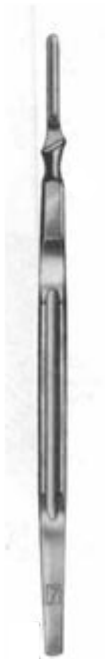

Scalpel Handle No. 7K
01-0006-7K



Collin No. 8
01-0007-08



Collin No. 9
01-0008-09



Double handle
Number 3 + Number 4
01-0009-34

General Instruments

Scalpel Handles
Skalpelli-griffe

Poignées Scalpel
Los mangos de bisturi



01

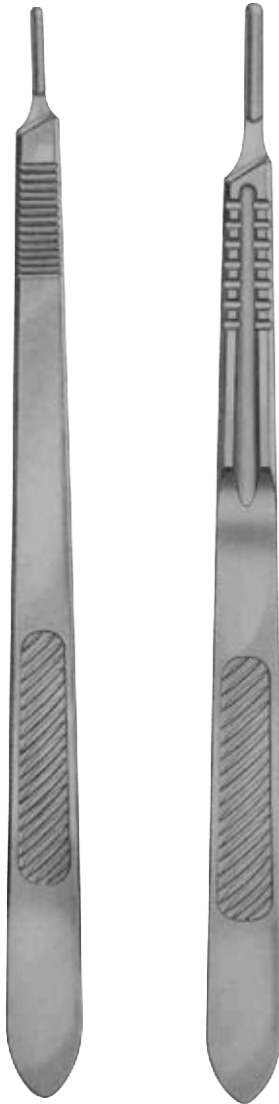

**Scalpel Handle
No. 3L**
01-0010-03

**Scalpel Handle
No. 4L**
01-0011-04

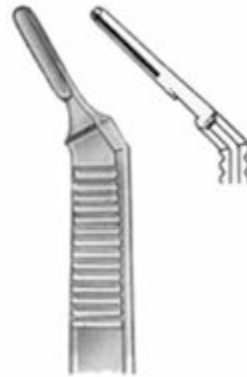

3L
01-0012-03

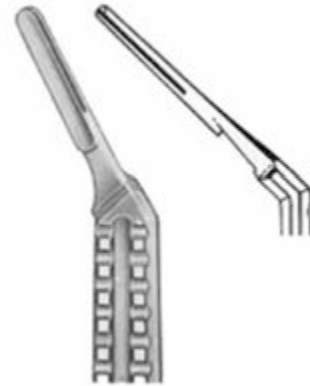

4L
01-0013-04



**Scalpel Plastic
Handle
No. 5**
01-0014-13



**Scalpel Handle
No. 5**
01-0015-05
15cm/6"



**Scalpel Handle
No. 5A**
01-0016-15
15cm/6"

General Instruments

Scalpel Handles
Skalpelli-griffe

Poignées Scalpel
Los mangos de bisturí

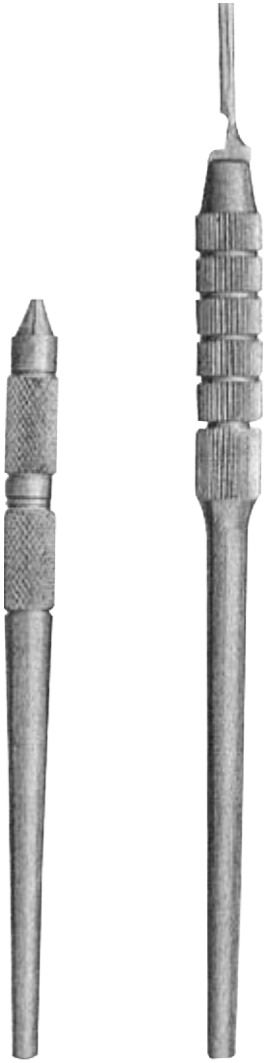

Scalpel Handle
01-0017-11
11.4cm/4 1/2"



Scalpel Handle
01-0018-16
16cm/6 1/4"



Scalpel Handle
01-0019-12
12.7cm/5"



Scalpel Handle
01-0020-11
11cm/4 1/4"



Scalpel Handle
01-0021-12
12.7cm/5"



Scalpel Handle
01-0022-13
13.5cm/5 1/4"



Scalpel Handle
01-0023-12
12cm/4 3/4"

General Instruments

Operating knives
Betriebssystem Messer

Couteaux d'exploitation
Cuchillos de funcionamiento



01



17cm/6 3/4"



Fig. 01
01-0024-01



Fig. 02
01-0024-02



Fig. 03
01-0024-03



Fig. 04
01-0024-04



Fig. 05
01-0024-05



Fig. 06
01-0024-06



Fig. 07
01-0024-07



Fig. 08
01-0024-08



Fig. 09
01-0024-09



Fig. 10
01-0024-10

General Instruments

Operating knives
Betriebssystem Messer

Couteaux d'exploitation
Cuchillos de funcionamiento



17cm/6 3/4"



Fig. 01 01-0025-01 **Fig. 02** 01-0025-02 **Fig. 03** 01-0025-03 **Fig. 04** 01-0025-04 **Fig. 05** 01-0025-05 **Fig. 06** 01-0025-06 **Fig. 07** 01-0025-07 **Fig. 08** 01-0025-08 **Fig. 09** 01-0025-09

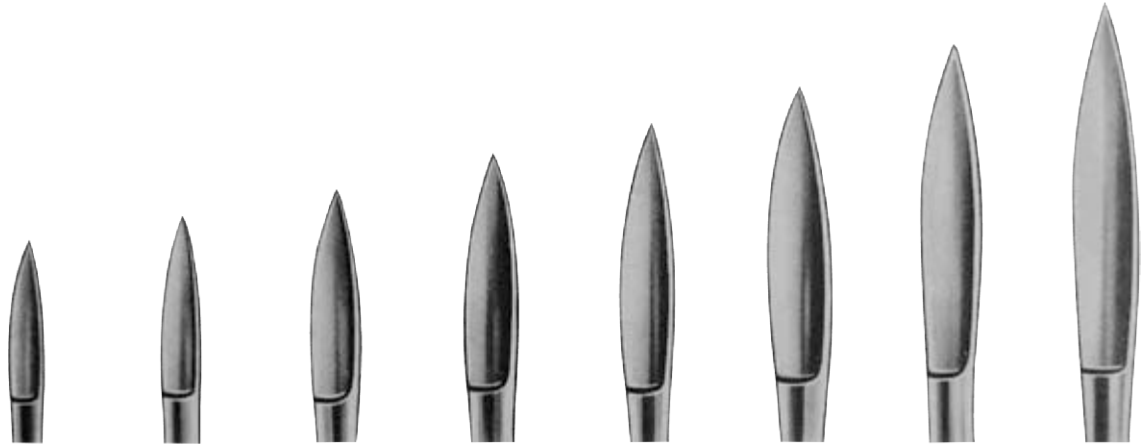

Fig. 10 01-0025-10 **Fig. 11** 01-0025-11 **Fig. 12** 01-0025-12 **Fig. 13** 01-0025-13 **Fig. 14** 01-0025-14 **Fig. 15** 01-0025-15 **Fig. 16** 01-0025-16 **Fig. 18** 01-0025-18



Fig. 27 01-0025-27 **Fig. 38** 01-0025-38 **Fig. 40** 01-0025-40 **Fig. 46** 01-0025-46 **Fig. 61** 01-0025-61 **Fig. 63** 01-0025-63

General Instruments

Operating knives
Betriebssystem Messer

Couteaux d'exploitation
Cuchillos de funcionamiento



01



Dieffenbach
17cm/6 3/4"



Fig. 01
01-0026-01



Fig. 02
01-0026-02



Fig. 03
01-0026-03



Fig. 04
01-0026-04



Fig. 05
01-0026-05



Fig. 06
01-0026-06



Fig. 07
01-0026-07



Fig. 08
01-0026-08



Fig. 09
01-0026-09



Fig. 15
01-0026-15



Fig. 16
01-0026-16

General Instruments

Operating knives
Betriebssystem Messer

Couteaux d'exploitation
Cuchillos de funcionamiento



Bergmann
01-0027-01
14cm/5 3/4"



Fig. 02
01-0027-02



Fig. 03
01-0027-03



Fig. 04
01-0027-04



Deiffenbach
13cm/5 1/4"



Fig. 01
01-0028-01



Fig. 02
01-0028-02



Fig. 03
01-0028-03



Fig. 04
01-0028-04



Fig. 05
01-0028-05



Fig. 06
01-0028-06



Fig. 07
01-0028-07



Fig. 08
01-0028-08



Fig. 09
01-0028-09



Fig. 10
01-0028-10



Fig. 11
01-0028-11



Fig. 12
01-0028-12

General Instruments

Fistula Knives
Fistula Messer

Couteaux fistule
Cuchillos fistula



01



Simon
23.5cm/9 1/4"



Fig.01
01-0029-01



Fig.02
01-0029-02



Fig.03
01-0029-03



Fig.04
01-0029-04



Ulrich
22.5cm/9"



Fig.01
01-0030-01



Fig.02
01-0030-02



Fig.03
01-0030-03



Simon
20cm/8"



Fig.01
01-0031-01



Fig.02
01-0031-02



Fig.03
01-0031-03



Fig.04
01-0031-04



01-0032-01
7.5cm/3"



01-0032-02
8cm/3 1/2"

Razors

General Instruments

Amputation Knives
Amputation Messer

Couteaux amputation
Cuchillos de amputación



Flap knife
Klappe Messer
couteau rabat
solapa cuchillo

Phalangeal knife
phalangealen Messer
couteau phalangienne
cuchillo de falange

Interosseus knife
interossea Messer
couteau interosseux
cuchillo interóseo

Length of blades
Länge der Schaufeln
Longueur des pales
Longitud de las palas

Liston

Catlin

Langenbeck

cm	in			
9.5	3 ¾	01-0033-09		01-0037-09
11.0	4 ½	01-0033-11		01-0038-11
12.0	4 ¾	01-0033-12		01-0036-12
13.0	5	01-0033-13		
15.0	6	01-0033-15		
16.0	6 ¼	01-0033-16		01-0035-16
17.0	6 ¾		01-0034-17	
19.0	7 ½	01-0033-19		01-0035-19
20.0	8		01-0034-20	
22.0	8 ¾	01-0033-22		01-0035-22

General Instruments

Resection, Brains, Post Mortem
Resektion, Brains, Post Mortem

Résection, Brains, Post Mortem
La resección, Brains, Post Mortem



01

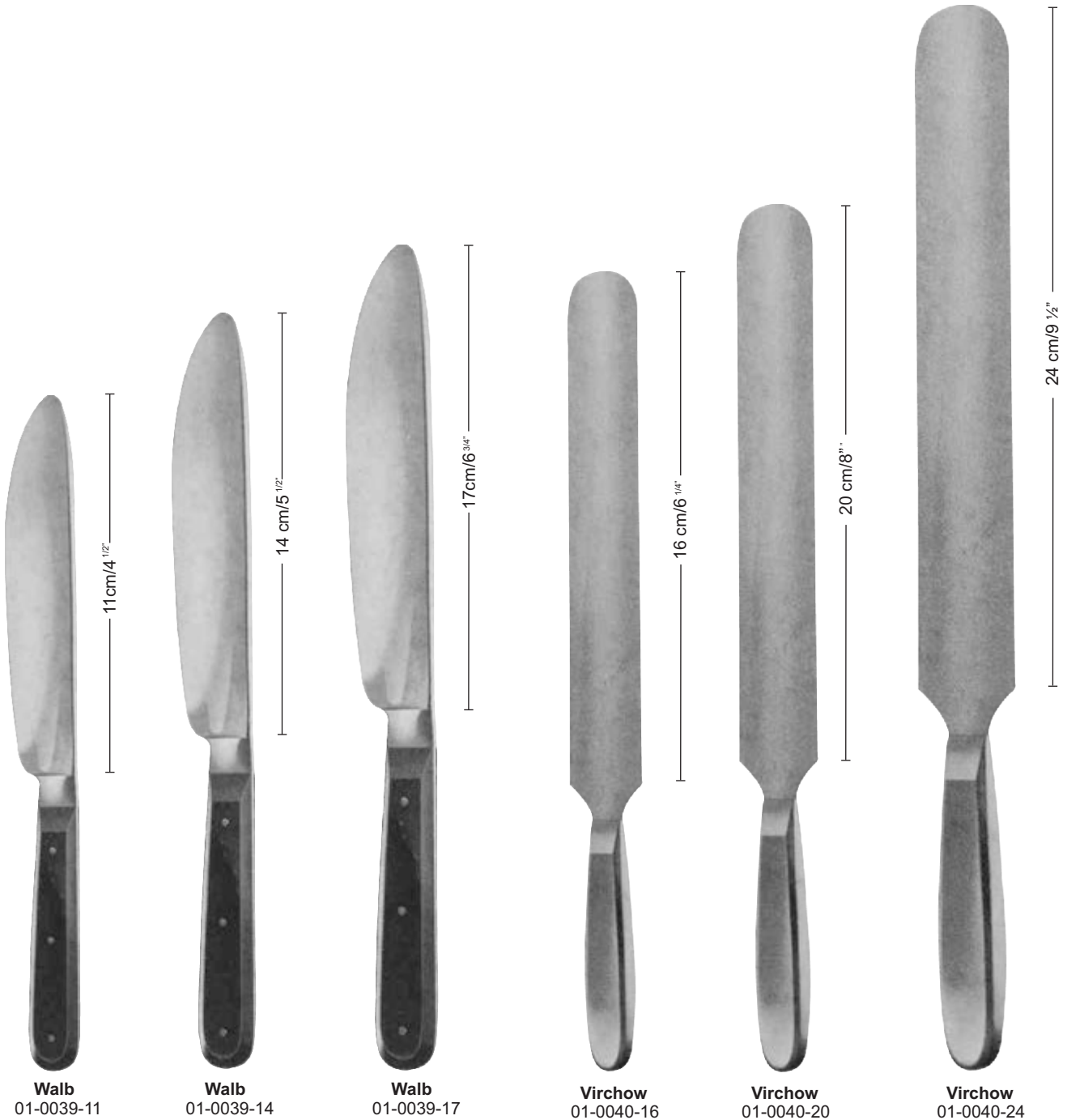

General Instruments

Cartilage Knives
Knorpel Messer

Couteaux du cartilage
Cuchillos de cartilago



01-0041-17
17.5 cm/7"



01-0042-17
17.5 cm/7"



Virchow
01-0043-22
22 cm/8 ½"
90mm



Virchow
01-0044-22
22 cm/8 ½"
90mm



01-0045-21
21 cm/8 ¼"
70mm

General Instruments

Autopsy Knives
Autopsieskalpelle

Couteaux d'autopsie
Cuchillos de la autopsia



01



Virchow
01-0046-25
25 cm/10"



Virchow
01-0047-25
25 cm/10"



Virchow
01-0048-25
25 cm/10"



Virchow
01-0049-25
25 cm/10"
90mm



Virchow
01-0050-26
26 cm/10 1/4"
120mm



Virchow
01-0051-27
27 cm/10 1/2"
150mm



Brunetti
 01-0052-28
 28.5cm/11 1/4"



Brunetti
 01-0053-28
 28.5cm/11 1/4"



01-0054-13
 13cm/5"

Osteotome
 Osteotom
 ostéotome
 osteotomo



Brunetti
 01-0055-27
 27cm/10 1/2"



01-0056-22
 22cm/8 3/4"

Rachiotome



01-0057-14
 14cm/5 1/2"

General Instruments

Blow Pipes and Post Mortem Set
Blasrohre und Post Mortem Set

Chalumeaux et Set Mortem Mensaje
Sopletes y Set Mortem mensaje



01



01-0059-67



01-0060-68



01-0061-69



01-0058-57

Post mortem set in wooden case.

Consisting of:

- 2 Dissecting knives. 01-0024-03
- 1 Dissecting knife. 01-0024-07
- 1 post mortem knife. 01-0047-25
- 1 Cartilage knife. 01-0042-17
- 1 Scissors with probe-end, straight, 13 cm long (5 1/8") 01-0060-13
- 1 Dressing forceps, 13 cm long (5 1/8") 03-0550-13
- 1 Charrier 30 cm/12" 12-2066-30
- 1 Metal hammer. 12-2123-19
- 1 Osteotome. 01-0054-13
- 2 Dissecting hooks, double, 01-0063-06
- 2 Blow pipes, double, 01-0061-69
- 2 Probes with olive-ends, 13 cm long (5") 07-1372-13
- 3 suture needles, assorted sizes.



01-0062-07
7cm



01-0063-06
6.5cm



01-0064-10
10.5cm

General Instruments

Skin Grafting Knives
Hauttransplantation Messer

Couteaux greffes de peau
Injertos de 01 Cuchillos



Schink
01-0065-30
30cm/12"



Humby
01-0068-30
30cm/12"



Thiersch
01-0066-20
20cm/8"



Spare Blade
01-0067-75



Spare Blade
01-0069-76

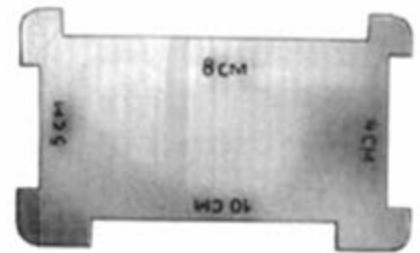

01-0070-77

General Instruments

Razor Blade Breakers
Razor Blade Breakers

Breakers de lames de rasoir
Breakers Razor blade

01



Treubnan-Chris
01-0071-09
9cm/3 1/2"



Treubnan-Chris
01-0072-09
9cm/3 1/2"



01-0073-11
11cm/4 1/2"



Castreviejo
01-0074-13
13cm/5 1/4"



Castreviejo
01-0075-18
18cm/7"

General Instruments

Dissecting Set
Dissecting Set

Trousse à dissection
La disección de Ajuste

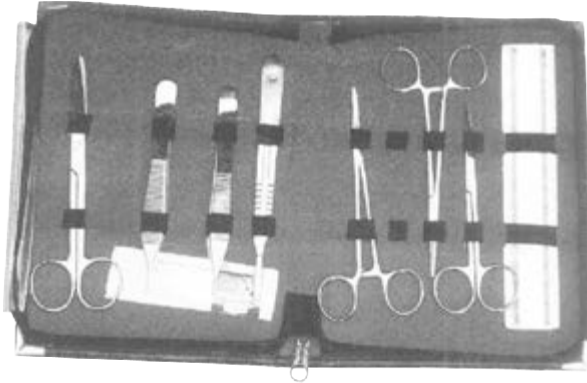

01-0076-83
Dissecting Set
Contains 9 Instruments

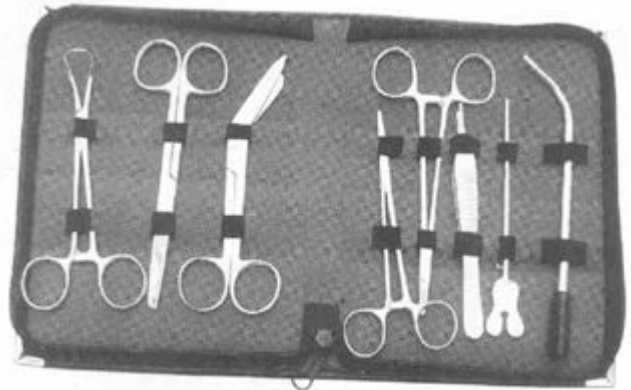

01-0077-84
Advance Anatomy Dissecting Set
Contains 8 Instruments

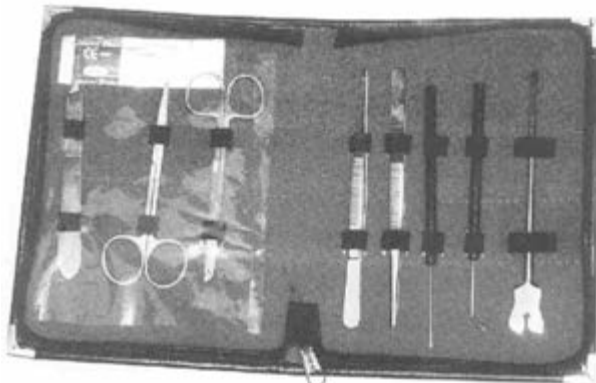

01-0078-85
Dissecting Set
Contains 9 Instruments



01-0079-86
Professional Dissecting Set
Contains 8 Instruments

General Instruments

Blow Pipes and Post Mortem Set
Blasrohre und Post Mortem Set

Chalumeaux et Post Mortem Set
Sopletes y Juegos de Post Mortem



01

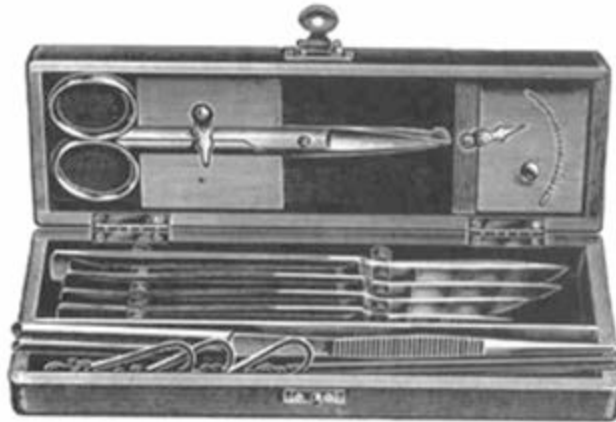

- 01-0080-13
Dissecting set
in wooden case, consisting of:
- 1 Dissecting knife 3"
 - 1 Dissecting knife 8"
 - 1 Cartilage knife 25"
 - 1 Scissors with probe-end,
13 cm long (5")
 - 1 Dressing forceps,
13 cm long (5")
 - 1 Tissue forceps,
13 cm long (5")
 - 1 Microscopic forceps,
10.5 cm long (4 1/4")
 - 1 Probe with eye,
13 cm long (5")
 - 1 Dissecting hook, double

- 01-0081-15
Dissecting set
in wooden case, consisting of:
- 1 Dissecting knife 3"
 - 1 Dissecting knife 5"
 - 1 Dissecting knife 8"
 - 1 Cartilage knife 25"
 - 1 Scissors with probe-end,
13 cm long (5")
 - 1 Dressing forceps,
13 cm long (5")
 - 1 Triple chain hook
 - 1 Blow pipe, double



- 01-0082-10
Dissecting set
in plastic case, consisting of:
- 1 Dissecting knife 3"
 - 1 Dissecting knife 5"
 - 1 Dissecting knife 8"
 - 1 Probe, Olive ends, 13 cm long (5")
 - 1 Grooved Director, 13 cm long (5")
 - 1 Dissecting hook, double
 - 1 Scissors with probe-end, 13cm long (5 1/8")
 - 1 Dressing forceps,
13 cm long(5")
 - 1 Blow pipe, double

General Instruments

Supercut Scissors
Ciseaux Supercut

Ciseaux Supercut
Tijeras Supercut



Straight
02-0090-14
Straight
straight
straight
straight

Curved
02-0091-14
14cm/5½"
Curved
Gebogene
courbé
Curvo



Mayo

02-0092-14 14cm/5½"
02-0092-17 17.0cm/6¾"
02-0092-23 23.0cm/9"
Straight
straight
straight
straight

02-0093-14
02-0093-17
02-0093-23
Curved
Gebogene
courbé
Curvo



Mayo-Stillle

02-0094-15 15.0cm/6"
02-0094-17 17.0cm/6¾"
Straight
straight
straight
straight

02-0095-15
02-0095-17
Curved
Gebogene
courbé
Curvo



Lexer

02-0096-16 16cm/6¼"
02-0097-16
Straight
straight
straight
straight

Curved
Gebogene
courbé
Curvo



Baby-Metzenbaum

02-0098-11 11.5cm/4½"
02-0099-11
Straight
straight
straight
straight

Curved
Gebogene
courbé
Curvo



Metzenbaum

02-0100-14 14 cm/5½"
02-0101-14
Straight
straight
straight
straight

Curved
Gebogene
courbé
Curvo



Metzenbaum-Fine

02-0102-14 14cm/5¾"
02-0102-18 18cm/7"
02-0102-20 20cm/8"
02-0102-23 23cm/9"

02-0103-14
02-0103-18
02-0103-20
02-0103-23

Straight
straight
straight
straight

Curved
Gebogene
courbé
Curvo

General Instruments

Supercut Scissors
Ciseaux Supercut

Ciseaux Supercut
Tijeras Supercut



02



Siebold
02-0104-24
24 cm/9½"



Sims
02-0105-20 20 cm/8"
02-0105-23 23 cm/9"
02-0106-20
02-0106-23
Striight
striight
striight
striight
Curved
Gebogene
courbé
Curvo



Reynolds
02-0107-15 15 cm/6"
02-0108-15
Striight
striight
striight
striight
Curved
Gebogene
courbé
Curvo



Jameson
02-0109-15 15 cm/6"
02-0109-18 18 cm/7"



02-0110-11 11.5 cm/4½"
02-0111-11
Striight
striight
striight
striight
Curved
Gebogene
courbé
Curvo



Plastic Surgery
02-0112-12 12 cm/4¾"
02-0113-12
Striight
striight
striight
striight
Curved
Gebogene
courbé
Curvo



Wagner
02-0114-12 12 cm/4¾"
02-0115-12
Striight
striight
striight
striight
Curved
Gebogene
courbé
Curvo

General Instruments

Supercut Scissors
Ciseaux Supercut

Ciseaux Supercut
Tijeras Supercut



Fomon
02-0116-13
13 cm/5"



Fomon
02-0117-13
13 cm/5"



Cottle
02-0118-16
16cm/6 1/4"



Heymann
02-0119-18
18 cm/7"



Braun-Stadler
02-0120-14 14 cm/5 1/2"
02-0120-22 22 cm/8 3/4"



Lister
02-0121-14 14 cm/5 1/2"
02-0121-18 18 cm/7"
02-0121-20 20 cm/8"



Stevens
Straight 02-0122-11 11.5 cm/4 1/2"
Curved 02-0123-11
Curved Gebogene
straight courbé
straight Curvo

General Instruments

Supercut Scissors
Ciseaux Supercut

Ciseaux Supercut
Tijeras Supercut



02

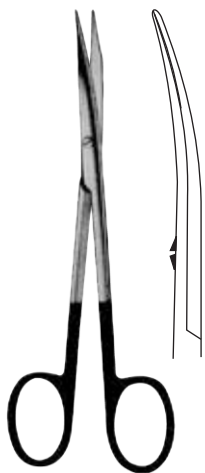

02-0124-11
11.5 cm/4 1/2"



02-0125-14
14 cm/5 1/2"

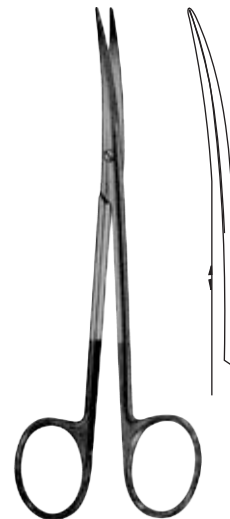

Reynolds
02-0126-13
13 cm/5"

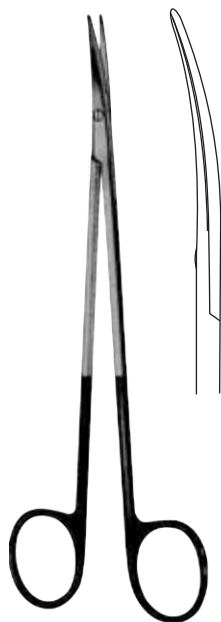

02-0127-17
17 cm/6 3/4"



Potts-Smith
19 cm/7 1/2"

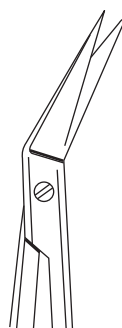

25°
02-0128-19

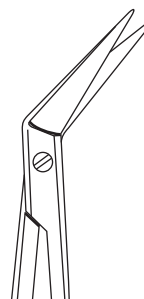

45°
02-0129-19

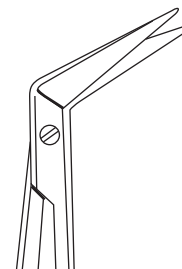

60°
02-0130-19

General Instruments

Operating Scissors
Chirurgische Scheren

Ciseaux d'exploitation
Tijeras de funcionamiento



Standard
Fig. 1

10.0	cm/4"	02-0131-10
11.5	cm/4½"	02-0131-11
13.0	cm/5"	02-0131-13
14	cm/5½"	02-0131-14
15	cm/6"	02-0131-15
16.0	cm/6¼"	02-0131-16
18.0	cm/7"	02-0131-18
20.0	cm/8"	02-0131-20

Curved
Gebogene
courbé
Curvo



Standard
Fig. 2

02-0132-10
02-0132-11
02-0132-13
02-0132-14
02-0132-15
02-0132-16
02-0132-18
02-0132-20

Curved
Gebogene
courbé
Curvo



Standard
Fig. 3

02-0133-10
02-0133-11
02-0133-13
02-0133-14
02-0133-15
02-0133-16
02-0133-18
02-0133-20



Standard
14 cm/5½"



Fig. 1
02-0134-14



Fig. 2
02-0135-14



Fig. 3
02-0136-14

General Instruments

Operating Scissors
Chirurgische Scheren

Ciseaux d'exploitation
Tijeras de funcionamiento



02



Standard
Fig. 1

10.0	cm/4"	02-0137-10
11.5	cm/4½"	02-0137-11
13.0	cm/5"	02-0137-13
14	cm/5½"	02-0137-14
15	cm/6"	02-0137-15
16.0	cm/6¼"	02-0137-16
18.0	cm/7"	02-0137-18
20.0	cm/8"	02-0137-20

Straight
gerade
droit
recto



Standard
Fig. 2

02-0138-10
02-0138-11
02-0138-13
02-0138-14
02-0138-15
02-0138-16
02-0138-18
02-0138-20

Straight
gerade
droit
recto



Standard
Fig. 3

02-0139-10
02-0139-11
02-0139-13
02-0139-14
02-0139-15
02-0139-16
02-0139-18
02-0139-20



Standard
14cm/5½"



Fig. 1
02-0140-14



Fig. 2
02-0141-14

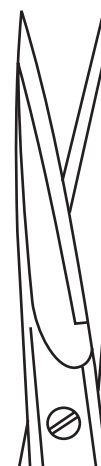

Fig. 3
02-0142-14

General Instruments

Dissecting Scissors
Präparierschere

Ciseaux à dissection
Tijeras de disección



Lexer
02-0143-16
16 cm/6¼"
Striaight
striaight
striaight
striaight



Lexer
02-0144-16
16 cm/6¼"
Curved
Gebogene
courbé
Curvo



Lexer
02-0145-16
16 cm/6¼"
Striaight
striaight
striaight
striaight



Lexer
02-0146-16
16 cm/6¼"
Curved
Gebogene
courbé
Curvo



Lexer-Fine
02-0147-16
16 cm/6¼"
Striaight
striaight
striaight
striaight



Lexer-Fine
02-0148-16
16 cm/6¼"
Curved
Gebogene
courbé
Curvo



Lexer-Fine
02-0149-16
16 cm/6¼"
Striaight
striaight
striaight
striaight



Lexer-Fine
02-0150-16
16 cm/6¼"
Curved
Gebogene
courbé
Curvo

General Instruments

Operating Scissors
Chirurgische Scheren

Ciseaux d'exploitation
Tijeras de funcionamiento



02



Graziil



02-0151-13 13.0 cm/5"
02-0151-14 14 cm/5½"
02-0152-13
02-0152-14
Curved
Gebogene
courbé
Curvo



Graziil

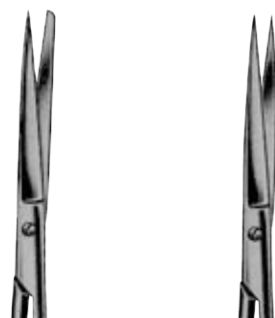

02-0153-13 13.0 cm/5"
02-0153-14 14 cm/5½"
02-0154-13
02-0154-14
Striaght
striaght
striaght
striaght



02-0155-15
Striaght
striaght
striaght
striaght

Mixer
15 cm/6"



02-0156-15
Curved
Gebogene
courbé
Curvo



02-0157-14
Striaght
striaght
striaght
striaght

Deaver
14 cm/5½"



02-0158-14
Curved
Gebogene
courbé
Curvo

General Instruments

Operating Scissors
Chirurgische Scheren

Ciseaux d'exploitation
Tijeras de funcionamiento



Richter
02-0159-14
14 cm/5 1/2"



Richter
02-0160-14
14 cm/5 1/2"



02-0161-13 13.0 cm/5 1/4"
02-0161-14 14 cm/5 1/2"



02-0162-15
15 cm/6"



Fergusson
02-0163-18
18 cm/7"



New Suture
02-0164-14
14 cm/5 1/2"

General Instruments

Operating and Dissecting Scissors
Bedienen und Präparierschere

D'exploitation et de dissection Ciseaux
Operación y Tijeras de disección



02



Mayo

02-0165-14 14 cm/5 1/2"
02-0165-15 15.0 cm/6"
02-0165-17 17.0 cm/6 3/4"
02-0165-19 20.0 cm/8"
02-0165-23 23.0 cm/9"

Striaght
striaght
striaght
striaght



Mayo

02-0166-14 14 cm/5 1/2"
02-0166-15 15.0 cm/6"
02-0166-17 17.0 cm/6 3/4"
02-0166-19 20 cm/8 "
02-0166-23 23.0 cm/9"

Curved
Gebogene
courbé
Curvo



Mayo

02-0167-14 14 cm/5 1/2"
02-0167-17 17.0 cm/6 3/4"
02-0167-23 23.0 cm/9"

Striaght
striaght
striaght
striaght



Mayo

02-0168-14 14 cm/5 1/2"
02-0168-17 17.0 cm/6 3/4"
06-4168-23 23.0 cm/9"

Curved
Gebogene
courbé
Curvo



Mayo-Still

02-0169-15 15 cm/6"
02-0169-17 17 cm/6 3/4"
02-0169-19 20 cm/8"
02-0169-21 23cm/9 "

Striaght
striaght
striaght
striaght



Mayo-Still

02-0170-15 15 cm/6"
02-0170-17 17 cm/6 3/4"
02-0170-19 20 cm/8"
02-0170-21 23 cm/9"

Curved
Gebogene
courbé
Curvo



Mayo-Still

02-0171-15 15 cm/6"
02-0171-17 17 cm/6 3/4"

Striaght
striaght
striaght
striaght



Mayo-Still

02-0172-15 15 cm/6"
02-0172-17 17 cm/6 3/4"

Curved
Gebogene
courbé
Curvo

General Instruments

Operating and Dissecting Scissors
Bedienen und Präparierschere

D'exploitation et de dissection Ciseaux
Operación y Tijeras de disección



Baby-Metzenbaum
02-0173-11
11.5 cm/4½"



Baby-Metzenbaum
02-0174-11
11.5 cm/4½"



Mayo-Noble
02-0175-17
17 cm/6¾"



Mayo-Noble
02-0176-17
17 cm/6¾"

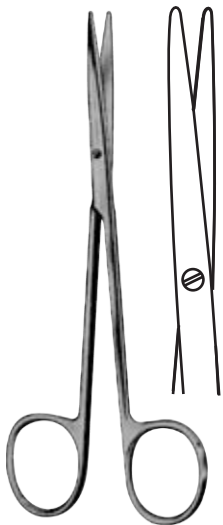

Metzenbaum-Fine
02-0177-14
14 cm/5½"

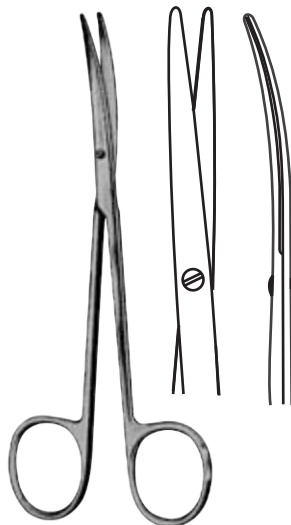

Metzenbaum-Fine
02-0178-14
14 cm/5½"

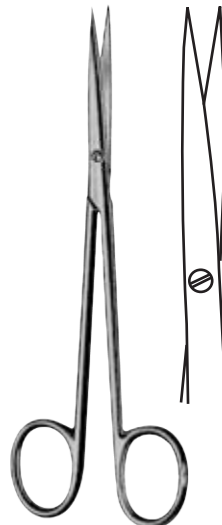

Metzenbaum-Fine
02-0179-14
14 cm/5½"

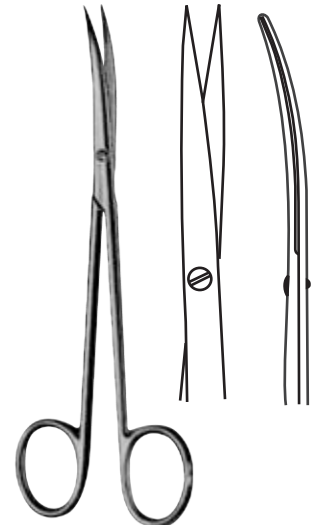

Metzenbaum-Fine
02-0180-14
14 cm/5½"

General Instruments

Dissecting Scissors
Präparierschere

Ciseaux à dissection
Tijeras de disección



02



Fig 1

Metzenbaum
02-0181-14
14 cm/5 1/2"

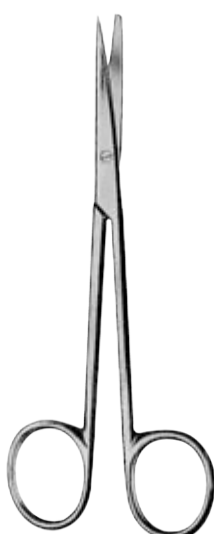

Fig 2

Metzenbaum
02-0182-14
14 cm/5 1/2"

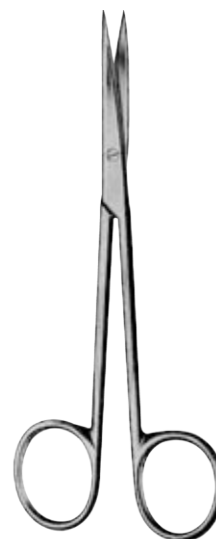
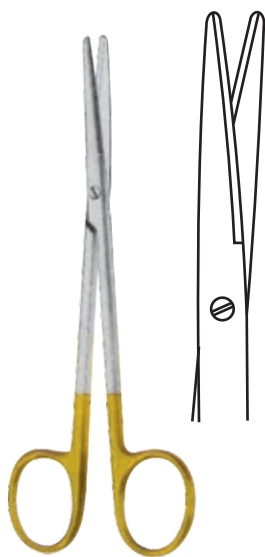
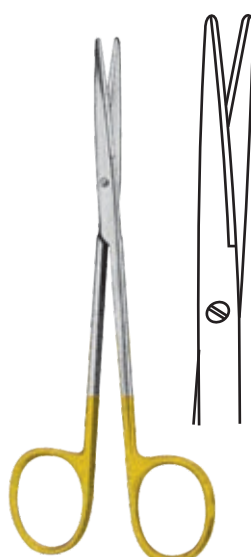

Fig 3

Metzenbaum
02-0183-14
14 cm/5 1/2"



Metzenbaum
02-0184-14
14 cm/5 1/2"



Metzenbaum-Fine
02-0185-14
14 cm/5 1/2"

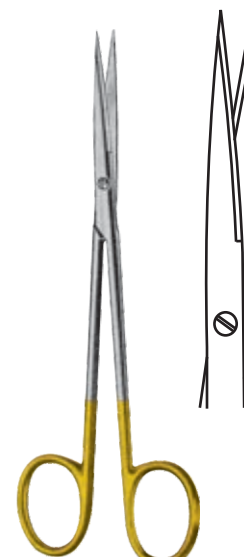

Metzenbaum-Fine
02-0186-14
14 cm/5 1/2"

General Instruments

Dissecting Scissors
Präparierschere

Ciseaux à dissection
Tijeras de disección



Fig. 1
Metzenbaum
02-0187-14
14 cm/5 1/2"

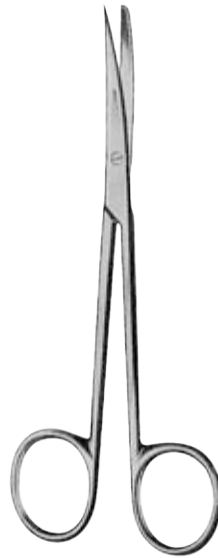
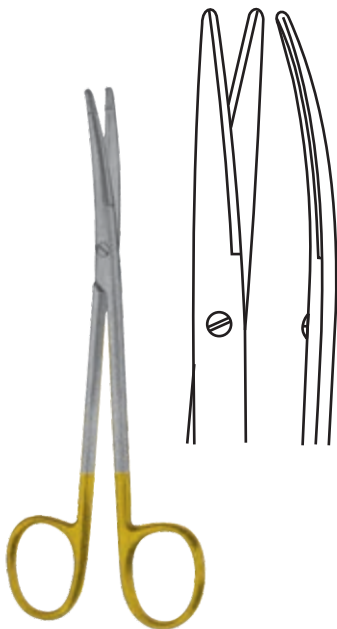

Fig. 2
Metzenbaum
02-0188-14
14 cm/5 1/2"



Fig. 3
Metzenbaum
02-0189-14
14 cm/5 1/2"



Metzenbaum
02-0190-14
14 cm/5 1/2"

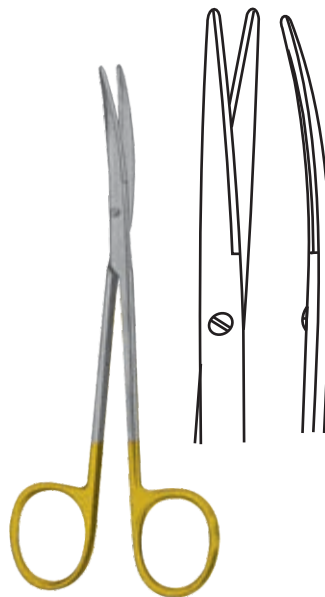

Metzenbaum-Fine
02-0191-14
14 cm/5 1/2"

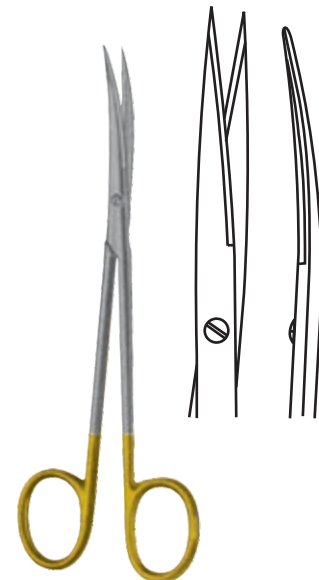

Metzenbaum-Fine
02-0192-14
14 cm/5 1/2"

General Instruments

Dissecting Scissors
Präparierschere

Ciseaux à dissection
Tijeras de disección



02



Metzenbaum-Fine

18 cm/7"	02-0193-18
20 cm/8"	02-0193-20
23 cm/9"	02-0193-23
25 cm/10"	02-0193-25
28 cm/11"	
30 cm/12"	



Metzenbaum

02-0194-18
02-0194-20
02-0194-23
02-0194-25
02-0194-28
02-0194-30



Metzenbaum

02-0195-18
02-0195-20
02-0195-23
02-0195-25
02-0195-28
02-0195-30



Metzenbaum

02-0196-18
02-0196-20
02-0196-23
02-0196-25
02-0196-28
02-0196-30



Metzenbaum

18 cm/7"	02-0197-18
20 cm/8"	02-0197-20
23 cm/9"	02-0197-23
25 cm/10"	02-0197-25
28 cm/11"	02-0197-28
30 cm/12"	02-0197-30



Metzenbaum-Fine

02-0198-18
02-0198-20
02-0198-23
02-0198-25



Metzenbaum-Fine

02-0199-18
02-0199-20
02-0199-23
02-0199-25

General Instruments

Dissecting Scissors
Präparierschere

Ciseaux à dissection
Tijeras de disección



Metzenbaum-Fine

18 cm/7" 02-0200-18
20 cm/8" 02-0200-20
23 cm/9" 02-0200-23
25 cm/10" 02-0200-25
28 cm/11" 02-0200-28
30 cm/12" 02-0200-30



Metzenbaum

02-0201-18
02-0201-20
02-0201-23
02-0201-25
02-0201-28
02-0201-30



Metzenbaum

02-0202-18
02-0202-20
02-0202-23
02-0202-25
02-0202-28
02-0202-30



Metzenbaum

02-0203-18
02-0203-20
02-0203-23
02-0203-25
02-0203-28
02-0203-30



Metzenbaum

18 cm/7" 02-0204-18
20 cm/8" 02-0204-20
23 cm/9" 02-0204-23
25 cm/10" 02-0204-25
28 cm/11" 02-0204-28
30 cm/12" 02-0204-30



Metzenbaum-Fino

02-0205-18
02-0205-20
02-0205-23
02-0205-25
02-0205-28



Metzenbaum-Fino

02-0206-18
02-0206-20
02-0206-23

General Instruments

Gynecological Scissors
gynäkologische Scheren

Ciseaux gynécologiques
Tijeras ginecológicas



02



Sims
02-0207-20 20 cm/8"
02-0207-23 23 cm/9"



02-0208-20 20 cm/8" 02-0209-20
02-0208-23 23 cm/9" 02-0209-23
Striight
striight
striight
striight



Sims
02-0210-20 20 cm/8"
02-0210-23 23 cm/9"



02-0211-20 20 cm/8" 02-0212-20
02-0211-23 23 cm/9" 02-0212-23
Curved
Gebogene
courbé
Curvo

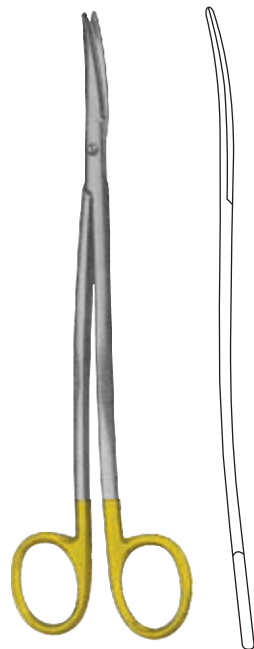

Metzenbaum-Fino
02-0213-20 20 cm/8"
02-0213-23 23 cm/7"

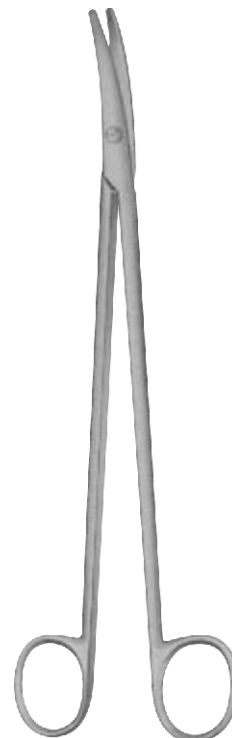

Weller
02-0214-14 14 cm/5 1/2"
02-0214-19 19.5 cm/7 3/4"
02-0214-22 22.5 cm/9"

General Instruments

Gynecological Scissors
gynäkologische Scheren

Ciseaux gynécologiques
Tijeras ginecológicas



Dubois
02-0215-27 27cm/10 ½"

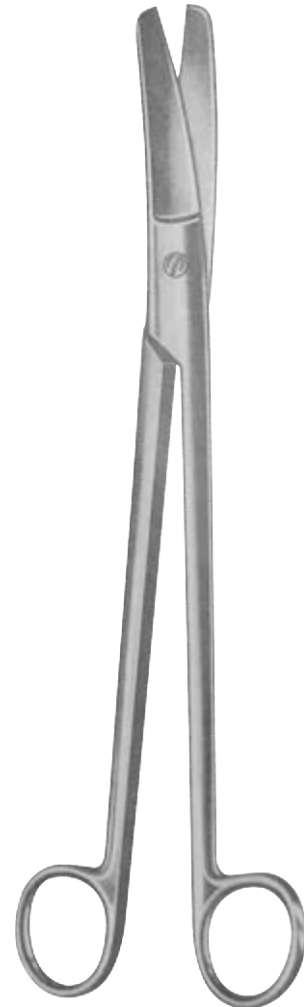

Dubois
02-0216-27 27cm/10 ½"



Sims
02-0217-20 20 cm/8"
02-0217-23 23 cm/9"

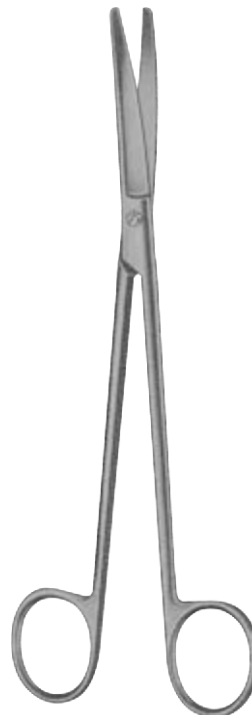

Wertheim
02-0218-14 14 cm/5 ½"
02-0218-19 19.5cm/7 ¾"
02-0218-22 22.5cm/9"

General Instruments

Gynecological Scissors
gynäkologische Scheren

Ciseaux gynécologiques
Tijeras ginecológicas

02



Kelly
16 cm/6 1/4" 02-0219-16
18 cm/7" 02-0219-18



Kelly
02-0220-16
02-0220-18



Siebold
02-0221-24 24 cm/9 1/2"



Deyen
16 cm/6 1/4" 02-0222-16
18 cm/7" 02-0222-18



Deyen
02-0223-16
02-0223-18



Deyen
02-0224-16
02-0224-18

General Instruments

Fine Operating Scissors
Feine Operating Schere

Ciseaux d'exploitation Beaux-
Tijeras finas de funcionamiento



Fig. 01
02-0225-12



Fig. 2
02-0226-12
S/B



Striaght
striaght
striaght
striaght
12 cm/4^{3/4}"

Fig. 3
02-0227-12
S/S



Fig. 1
02-0228-12



Fig. 2
02-0229-12
S/B



Curved
Gebogene
courbé
Curvo
12 cm/4^{3/4}"

Fig. 3
02-0230-12
S/S



Wagner
02-0231-12
12 cm/4^{3/4}"

Striaght
striaght
striaght
striaght



Fig. 1
02-0232-01



Fig. 2
02-0233-02



Fig. 3
02-0234-03

Curved
Gebogene
courbé
Curvo



Fig. 1
02-0235-01



Fig. 2
02-0236-02



Fig. 3
02-0237-03

Saw edge
Saw Rand
Scie à bord
Saw borde



Fig. 4
02-0238-04



Fig. 4
02-0239-04

Striaght
striaght
striaght
striaght



02-0240-11
11.5 cm/4^{1/2}"

Curved
Gebogene
courbé
Curvo



02-0241-11
11.5 cm/4^{1/2}"

General Instruments

Fine Scissors
feinen Schere

Ciseaux Beau-
tjeras finas



02



Brophy (Sullivan)
02-0242-14
14 cm/5½"
Striight
striight
striight
striight



02-0243-14
14 cm/5½"
Curved
Gebogene
courbé
Curvo



Reynolds
02-0244-15
02-0244-18
Striight
striight
striight
striight

15 cm/6"
18 cm/7"



02-0245-15
02-0245-18
Curved
Gebogene
courbé
Curvo

Enucleation Scissors



Jameson
02-0246-15
15 cm/6"



02-0247-12



02-0248-12



Landolt
12.5 cm /5"



02-0249-12



02-0250-12

General Instruments

Fine Scissors
feinen Schere

Ciseaux Beaux-
tijeras finas



02-0251-09
9cm/3½"

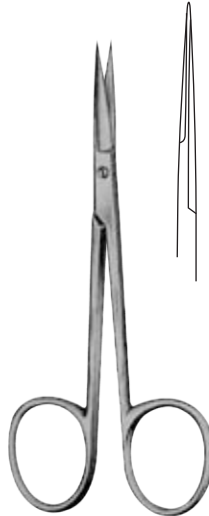

02-0252-10
10cm/4"

extra flat
extra flach
extra plat
extra plano



Walton
02-0253-10
10cm/4"



9.0 cm/3½"	02-0254-09	02-0255-09	02-0256-09	02-0257-09	Standard	02-0258-09
10.5 cm/4¼"	02-0254-10	02-0255-10	02-0256-10	02-0257-10		02-0258-10
11.5 cm/4½"	02-0254-11	02-0255-11	02-0256-11	02-0257-11		02-0258-11

General Instruments

Fine Scissors
feinen Schere

Ciseaux Beau-
tjeras finas



02

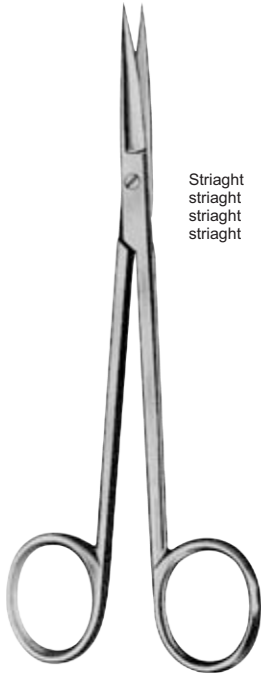

Striaght
striaght
striaght
striaght

02-0259-14

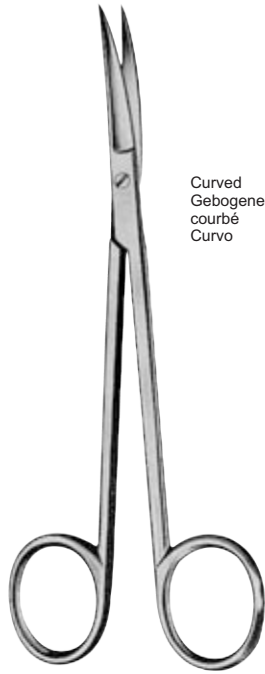

Curved
Gebogene
courbé
Curvo

02-0260-14

Sanvenero
14 cm/5 1/2"



Striaght
striaght
striaght
striaght

02-0261-10

Baby-Lexer (Knapp)
10cm/4"

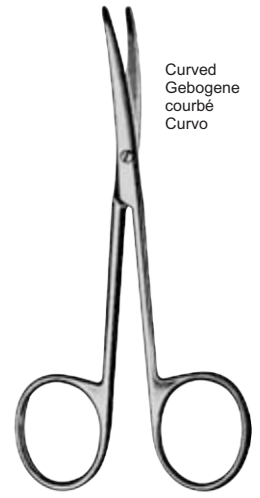

Curved
Gebogene
courbé
Curvo

02-0262-10



Striaght
striaght
striaght
striaght

02-0263-13

13cm/5"

02-0264-13

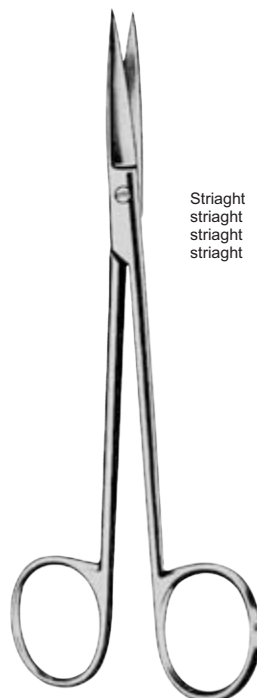

Striaght
striaght
striaght
striaght

02-0265-14

Joseph
14cm/5 1/2"



Curved
Gebogene
courbé
Curvo

02-0266-14

General Instruments

Dissecting and Vascular Scissors
Anatomische und vaskuläre Schere

Dissection et Ciseaux vasculaires
Tijeras de disección y vasculares



Kilner (Ragnell)
02-0267-12 12cm/4¾"
02-0267-13 13cm/5"
02-0267-15 15cm/6"



02-0268-14
14 cm/5 ½"

Coronary Scissors
Ciseaux coronaires
Tijeras coronarias

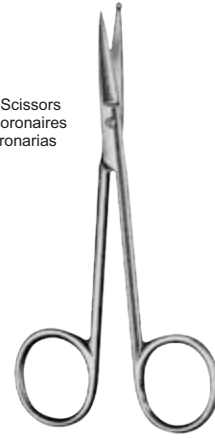

02-0269-11
11.5cm/4½"



Potts-Smith
02-0270-19
20 cm/8 "



De Bakey
02-0271-15
15.5cm/6"



De Bakey
02-0272-15
15.5cm/6"



Favaloro
02-0273-15
15cm/6"

General Instruments

Vascular Scissors
Vaskuläre Schere

Ciseaux vasculaires
Tijeras vasculares



02

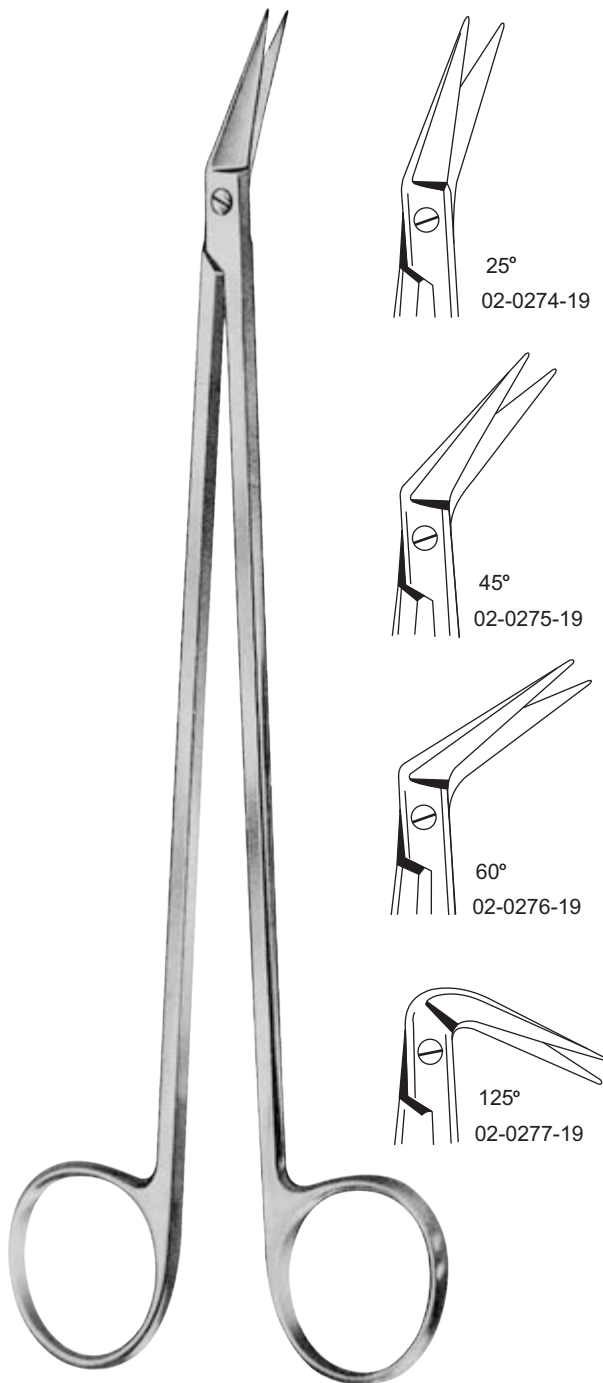

Potts-Smith
19cm/7 1/2"

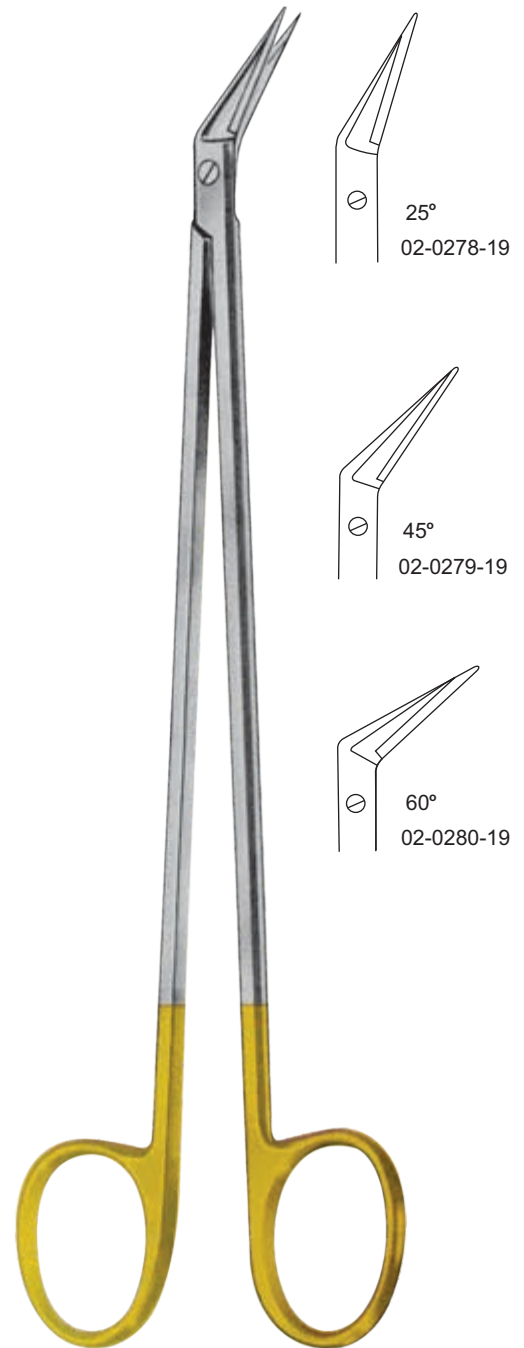

Potts-Smith
19cm/7 1/2"

General Instruments

Cartilage and Vascular Scissors
Knorpel-und Gefäß-Schere

Le cartilage et Ciseaux vasculaires
El cartilago y Tijeras vasculares



Saw edge
Saw Rand
Scie à bord
Saw borde

Martin-Cartilage
02-0281-20
20cm/8"



McIndoe
02-0282-19
19cm/7½"



Potts-Smith
02-0283-19
19cm/7½"



Satinsky
02-0284-24
24.5cm/10"



Klingenberg-Loth
02-0285-23
23cm/9"

General Instruments

Vascular Scissors
Vaskuläre Schere

Ciseaux vasculaires
Tijeras vasculares



02



De Bakey
18cm/7"

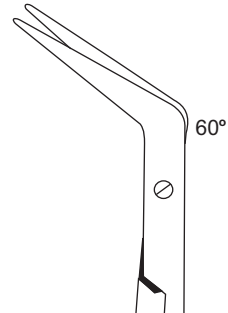
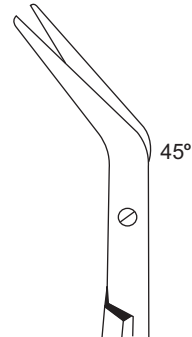
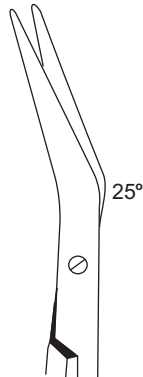

cm	In			
16.0cm	6¼"	02-0286-16	02-0287-16	02-0288-16
23.0cm	9"	02-0286-23	02-0287-23	02-0288-23
28.0cm	11"	02-0286-28	02-0287-28	02-0288-28



Baby-Hegemann
14 cm/5 ½"

Hegemann (Diethrich)
16cm/6¼"
19cm/7½"

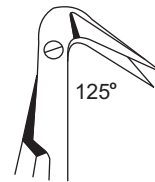
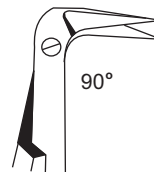
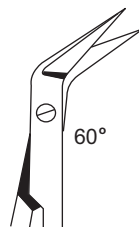
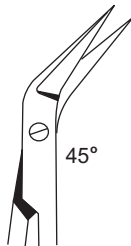
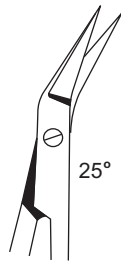

cm	In					
13.0cm	5¼"	02-0289-13	02-0290-13	02-0291-13	02-0292-13	02-0293-13
16.0cm	6¼"	02-0289-16	02-0290-16	02-0291-16	02-0292-16	02-0293-16
19.0cm	7½"	02-0289-19	02-0290-19	02-0291-19	02-0292-19	02-0293-19

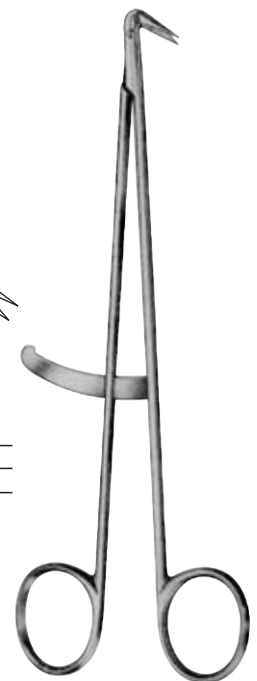

Hegemann (Diethrich)
02-0294-19
19cm/7½"

General Instruments

Vascular Scissors
Vaskuläre Schere

Ciseaux vasculaires
Tijeras vasculares

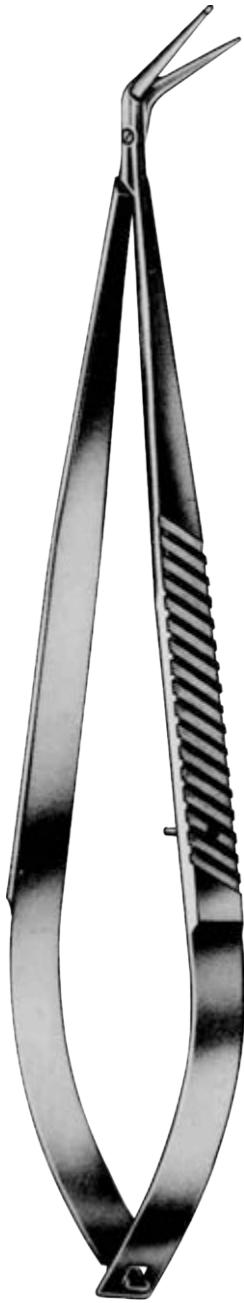

18cm/7"

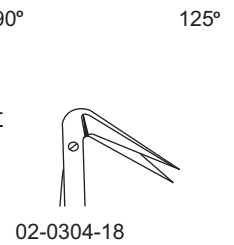
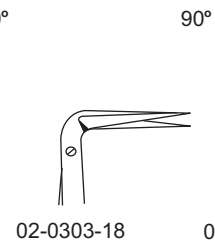
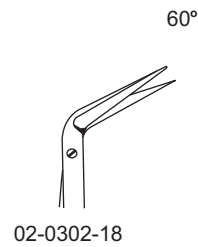
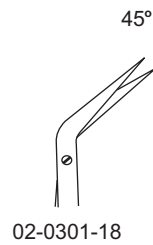
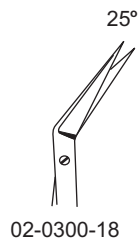
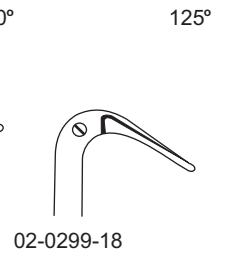
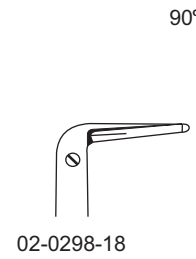
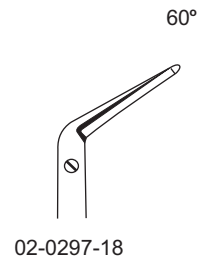
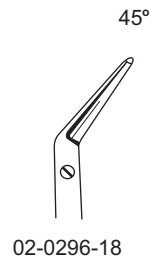
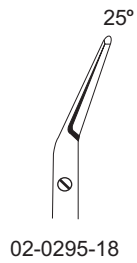

General Instruments

Dissecting and Tonsil Scissors
Anatomische und Tonsil Schere

Dissection et Ciseaux amygdales
Tijeras de disección y amígdalas



02



02-0305-15
15cm/6"



Bottcher
02-0306-18
18cm/7"



Prince
02-0307-17
17.5cm/7"



Adson-Fine
02-0308-17
17.5cm/7"



Tonnis
02-0309-18
18cm/7"



Tonnis
02-0310-18
18cm/7"



Adson
02-0311-17
17.5cm/7"



Adson
02-0312-17
17.5cm/7"

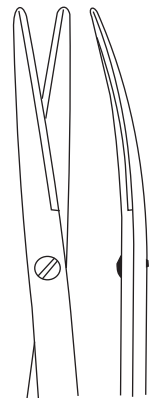

General Instruments

Tonsil and Enterotomy Scissors
Tonsil und Enterotomie Schere

Ciseaux amygdales et entérotomie
Las amígdalas y Enterotomía Tijeras



Good
02-0313-19
19 cm/7½"



Crafoord
02-0314-30
30 cm/12"



Finochietto
02-0315-27
27 cm/10½"



02-0316-21
21 cm/8¼"



02-0317-21
21 cm/8¼"



02-0318-21
21 cm/8¼"

General Instruments

Umbilicat and Episiotomy Scissors
Umbilicat und Dammscheren

Umbilicat et Ciseaux épisiotomie
Umbilicat y Tijeras Episiotomía



02



Busch
02-0319-13 13 cm/5"
02-0319-16 16 cm/6¼"



Schumacher
02-0320-16
16 cm/6¼"



Mod. USA
02-0321-10
10.5cm/4¼"
02-0321-12
12.5cm



Braun-Stadler
02-0322-14
14 cm/5½"



Braun-Stadler
02-0323-22
22 cm/8½"



Waldmann
02-0324-18
18 cm/7"

General Instruments

Perineum Episiotomy Scissors
Perineum Dammscheren

Ciseaux épisiotomie périnée
Tijeras perineo episiotomía



Parametrium Scissors
Ciseaux parametrium
parametrium Tijeras



02-0325-01
23 cm/9"



02-0325-02
23 cm/9"



02-0326-19
19 cm/7 1/2"



02-0327-19
19 cm/7 1/2"

General Instruments

Dissecting Trigeminal, Wire Cutting and Gum Scissors
Dissecting Trigeminus, Drahterodieren und Gum Schere

Dissection du trijumeau, coupe au fil et Ciseaux à caoutchouc
La dissection de corte del trigémino, alambre y tijeras de goma



02



Universal
02-0336-12
12 cm/4¾"



Goldman-Fox
02-0337-13
13 cm/5"
Striaght
striaght
striaght
striaght



Goldman-Fox
02-0338-13
13 cm/5"
Curved
Gebogene
courbé
Curvo

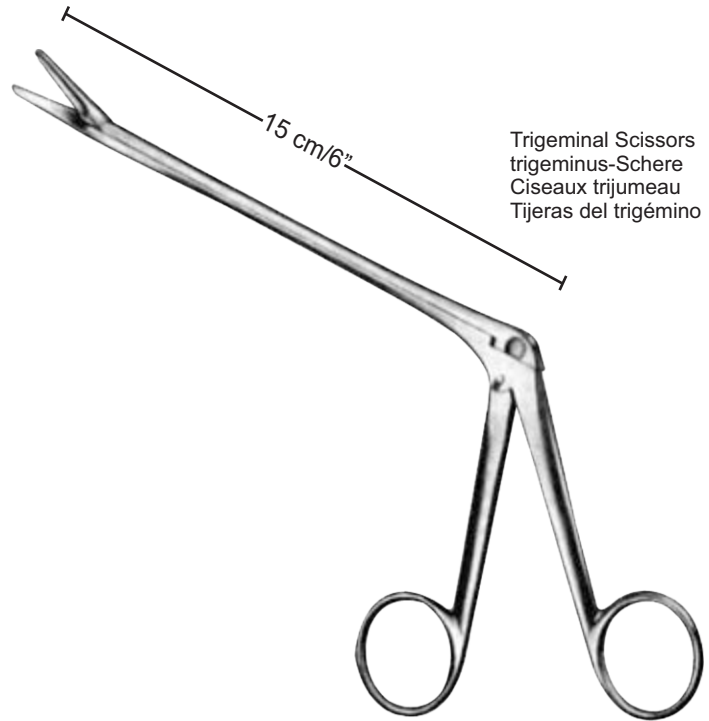

Trigeminal Scissors
trigeminus-Schere
Ciseaux trijumeau
Tijeras del trigémino



Dandy
02-0339-17
17 cm/6¾"

Olivecrona
02-0340-15



General Instruments

Nasal Forceps
Nasenschere

Ciseaux nasale
nasal Tijeras

02



Heymann
02-0328-18
18 cm/7"



Heymann
02-0329-19
20 cm/8 "



Knight
02-0330-18
18 cm/7"



Fomon
02-0331-13
13 cm/5"



Fomon
02-0332-13
13.5 cm/5¼"



Fomon
02-0333-13
13.5 cm/5¼"



Cottle
02-0334-16
16 cm/6¼"



Halle
02-0335-19
19 cm/7¼"

General Instruments

Iridectomy Scissors
Iridektomie Schere

Ciseaux iridectomie
Tijeras iridectomia



02



Barraquer
02-0341-05
5.5 cm/2¼"



Noyes
02-0342-01
02-0342-02
02-0342-03
12 cm/4¾"

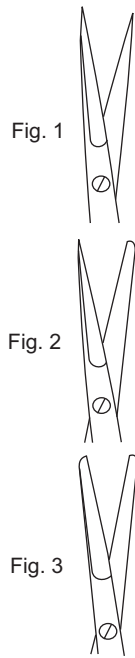

Noyes
02-0343-12
12 cm/4¾"

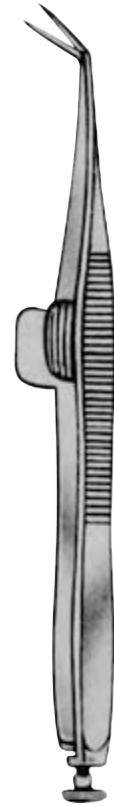

Wecker
02-0344-01
11.5 cm/4½"



02-0345-09
9 cm/3½"



02-0346-09



02-0347-09



02-0348-09



02-0349-09



02-0350-09

General Instruments

Iridectomy Scissors
Iridektomie Schere

Ciseaux iridectomie
Tijeras iridectomia



Striaight
striaight
striaight
striaight

Vannas
02-0351-08
8 cm/3¼"

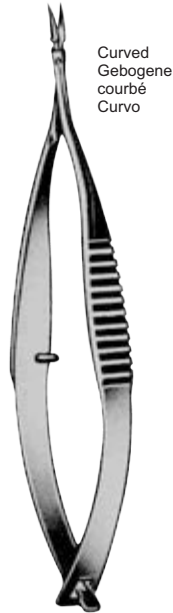

Curved
Gebogene
courbé
Curvo

Vannas
02-0352-08
8 cm/3¼"

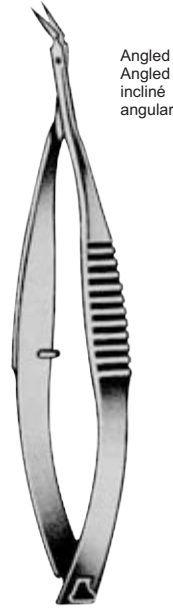

Angled
Angled
incliné
angular

Vannas
02-0353-08
8 cm/3¼"

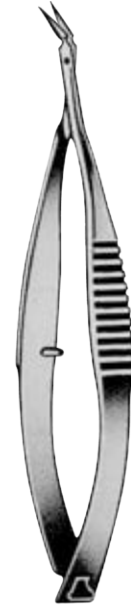

Vannas
02-0354-08
8 cm/3¼"

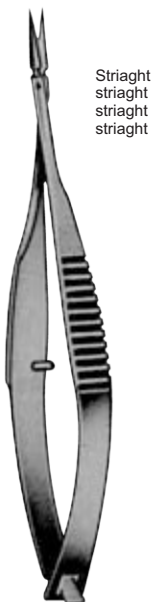

Striaight
striaight
striaight
striaight

02-0355-08
8.5 cm/3¼"

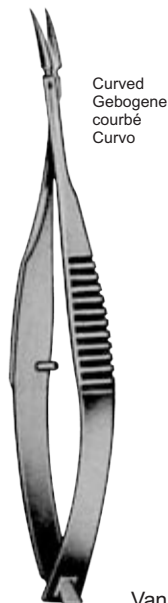

Curved
Gebogene
courbé
Curvo

Vannas Mod, Tubingen
02-0356-08
8.5 cm/3½"

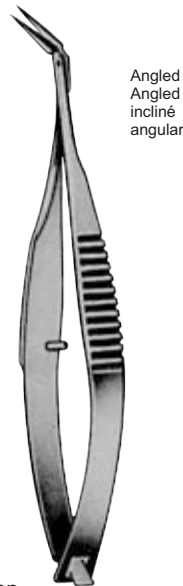

Angled
Angled
incliné
angular

02-0357-08
8.5 cm/3½"

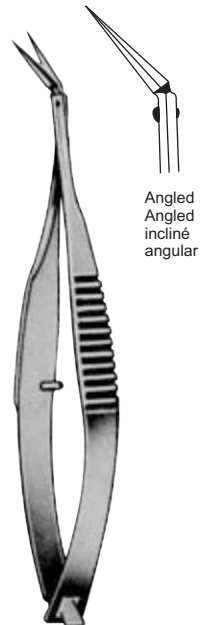

Angled
Angled
incliné
angular

02-0358-08
8.5 cm/3½"

General Instruments

Iridectomy Scissors
Iridektomie Schere

Ciseaux iridectomie
Tijeras iridectomia



02



02-0359-10
10 cm/4"
?



02-0360-10
10 cm/4"
?



Castroviejo
02-0361-10
10 cm/4"

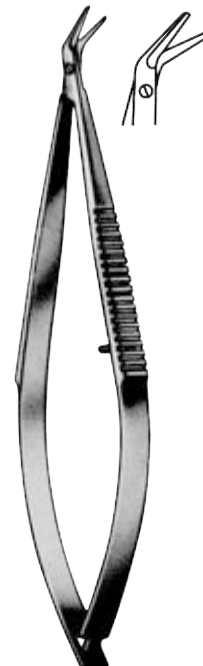

Castroviejo
02-0362-10
10 cm/4"



Aebil
02-0363-10
10 cm/4"



Castroviejo
02-0364-10
10 cm/4"



Castroviejo
02-0365-10
10 cm/4"

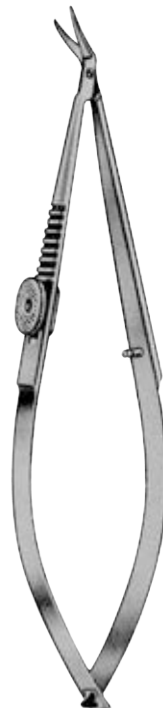

Troutman-Barraquer
02-0366-10
10 cm/4"



Troutman-Barraquer
02-0367-10
10 cm/4"

General Instruments

Iridectomy Scissors
Iridektomie Schere

Ciseaux iridectomie
Tijeras iridectomia



Troutman
02-0368-10
10 cm/4"



Troutman
02-0369-10
10 cm/4"



Katzin-Barraquer
02-0370-10
10 cm/4"



Katzin-Barraquer
02-0371-10
10 cm/4"



Katzin
02-0372-10
10 cm/4"



Katzin
02-0373-10
10 cm/4"



Westcott
02-0374-11
11.5 cm/4½"



Westcott
02-0375-11
11.5 cm/4½"



Westcott
02-0376-11
11.5 cm/4½"

General Instruments

Iridectomy Scissors
Iridektomie Schere

Ciseaux iridectomie
Tijeras iridectomia

02



Castroviejo
02-0377-10
10 cm/4"



Castroviejo
02-0378-10
10 cm/4"



Castroviejo
02-0379-11
11.5 cm/4½"



Castroviejo
02-0380-11
11.5 cm/4½"



Troutmann-Castroviejo
02-0381-10
10.5 cm/4¼"



Troutmann-Castroviejo
02-0382-10
10.5 cm/4¼"



Straight
02-0383-14
02-0383-18

Curved
02-0384-14
02-0384-18

14.5 cm/5¾"
18.0 cm/7"

General Instruments

Micro Scissors
Micro Scissors

Ciseaux Micro
Micro Tijeras



Striaight
striaght
striaght
striaght

02-0385-12 12.0 cm/4 3/4"
02-0385-16 16.0 cm/6 1/4"
02-0385-18 18.5 cm/7 1/4"



Curved
Gebogene
courbé
Curvo

02-0386-12 12.0 cm/4 3/4"
02-0386-16 16.0 cm/6 1/4"
02-0386-18 18.5 cm/7 1/4"



Striaight
striaght
striaght
striaght

16.5cm/6 1/2"
20.0cm/8"



Curved
Gebogene
courbé
Curvo

02-0387-16 02-0388-16
02-0387-20 02-0388-20



Striaight
striaght
striaght
striaght

22.5cm/9" 02-0389-22
24.5cm/9 3/4" 02-0389-24



Curved
Gebogene
courbé
Curvo

02-0390-22
02-0390-24

General Instruments

Micro Scissors
Micro Scissors

Ciseaux Micro
Micro Tijeras



02

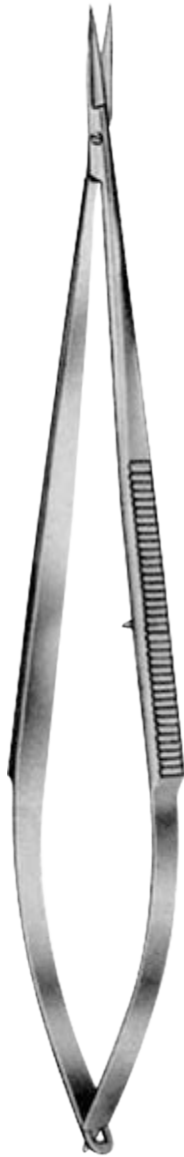
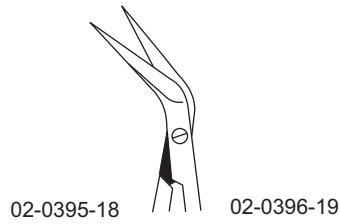
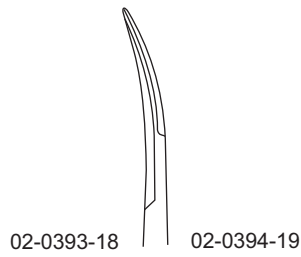
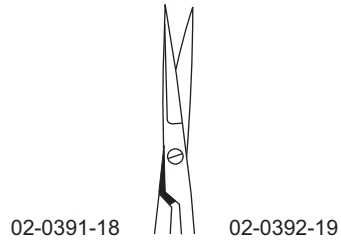

Jacobson
18cm/7"



19cm/7½"

General Instruments

Micro Scissors
Micro Scissors

Ciseaux Micro
Micro Tijeras

Vein Scissors
Ciseaux veine
Tijeras Vena



02-0399-12
12cm/4³/₄"

Striaight
striaight
striaight
striaight



02-0400-12
12cm/4³/₄"

Curved
Gebogene
courbé
Curvo



02-0401-12
12cm/4³/₄"

Striaight
striaight
striaight
striaight



02-0402-03
12cm/4³/₄"

Curved
Gebogene
courbé
Curvo



02-0403-12
12cm/4³/₄"

Angled up
abgewinkelt up
angle vers le haut
un ángulo de

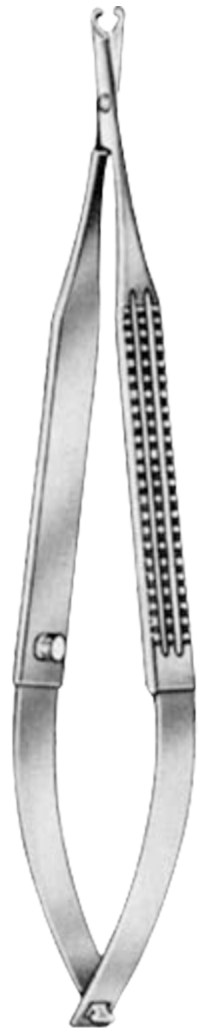

Straight
02-0404-13
13cm/5"

Striaight
striaight
striaight

General Instruments

Micro Scissors
Micro Scissors

Ciseaux Micro
Micro Tijeras



02

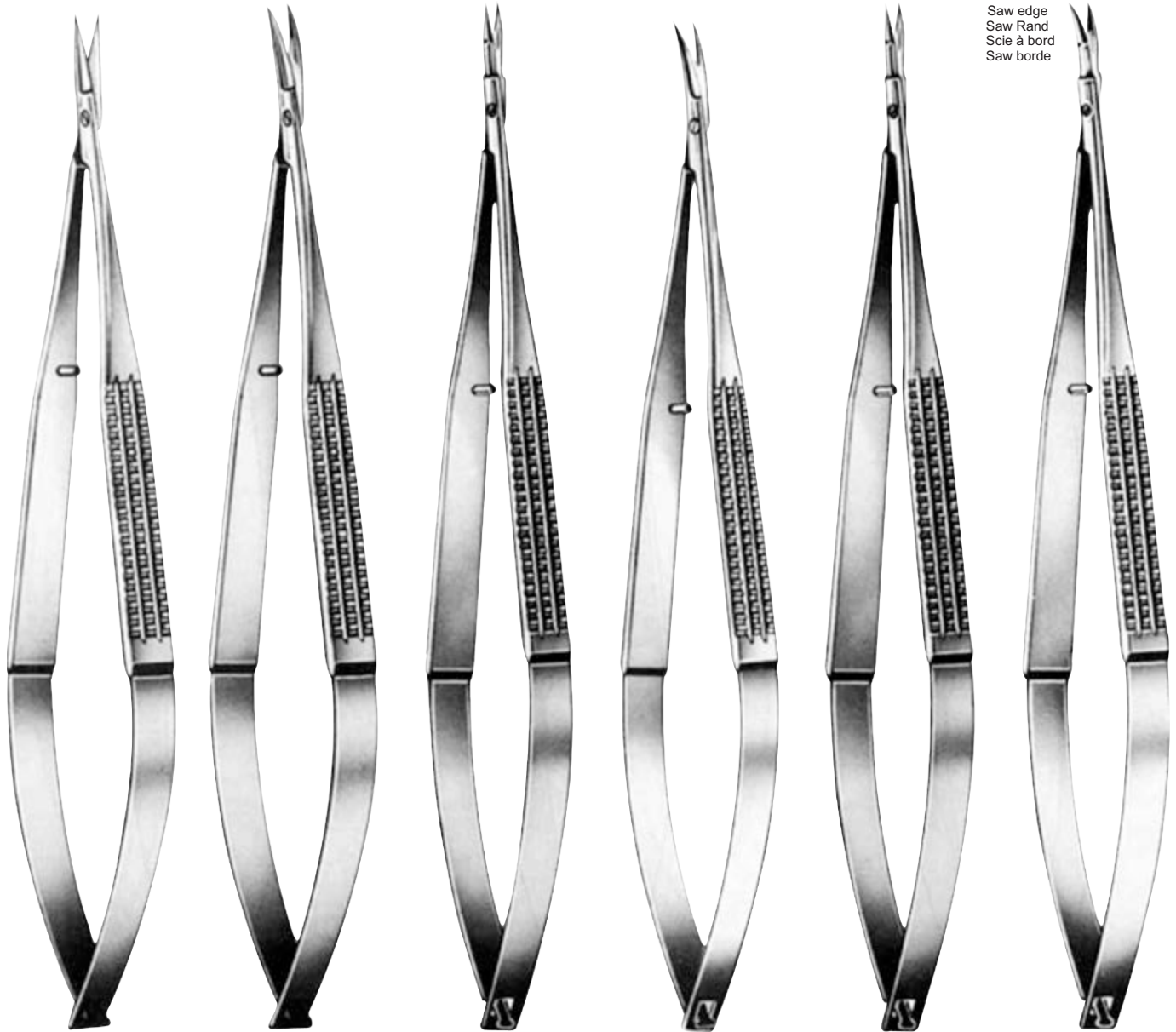

Saw edge
Saw Rand
Scie à bord
Saw borde

02-0405-16
16cm/6¼"
Striaght
striaght
striaght
striaght

02-0406-16
16cm/6¼"
Curved
Gebogene
courbé
Curvo

02-0407-16
16cm/6¼"
Striaght
striaght
striaght
striaght

02-0408-16
16cm/6¼"
Curved
Gebogene
courbé
Curvo

Millesi
02-0409-16
16cm/6¼"
Striaght
striaght
striaght
striaght

Millesi
02-0410-16
16cm/6¼"
Curved
Gebogene
courbé
Curvo

General Instruments

Micro Scissors
Micro Scissors

Ciseaux Micro
Micro Tijeras



02-0411-18
18.5cm/7¼"
Striight
striight
striight
striight



02-0412-18
18.5cm/7¼"
Curved
Gebogene
courbé
Curvo

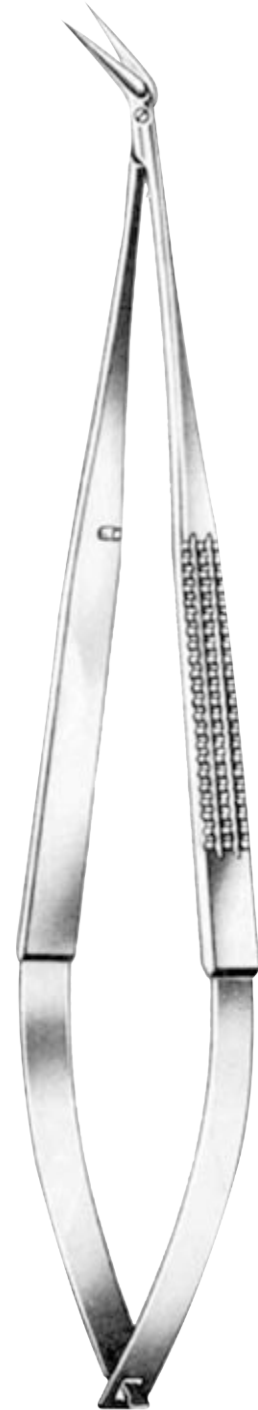

02-0413-18
18.5cm/7¼"
Angled
Angled
incliné
angular

General Instruments

Micro Scissors
Micro Scissors

Ciseaux Micro
Micro Tijeras



02

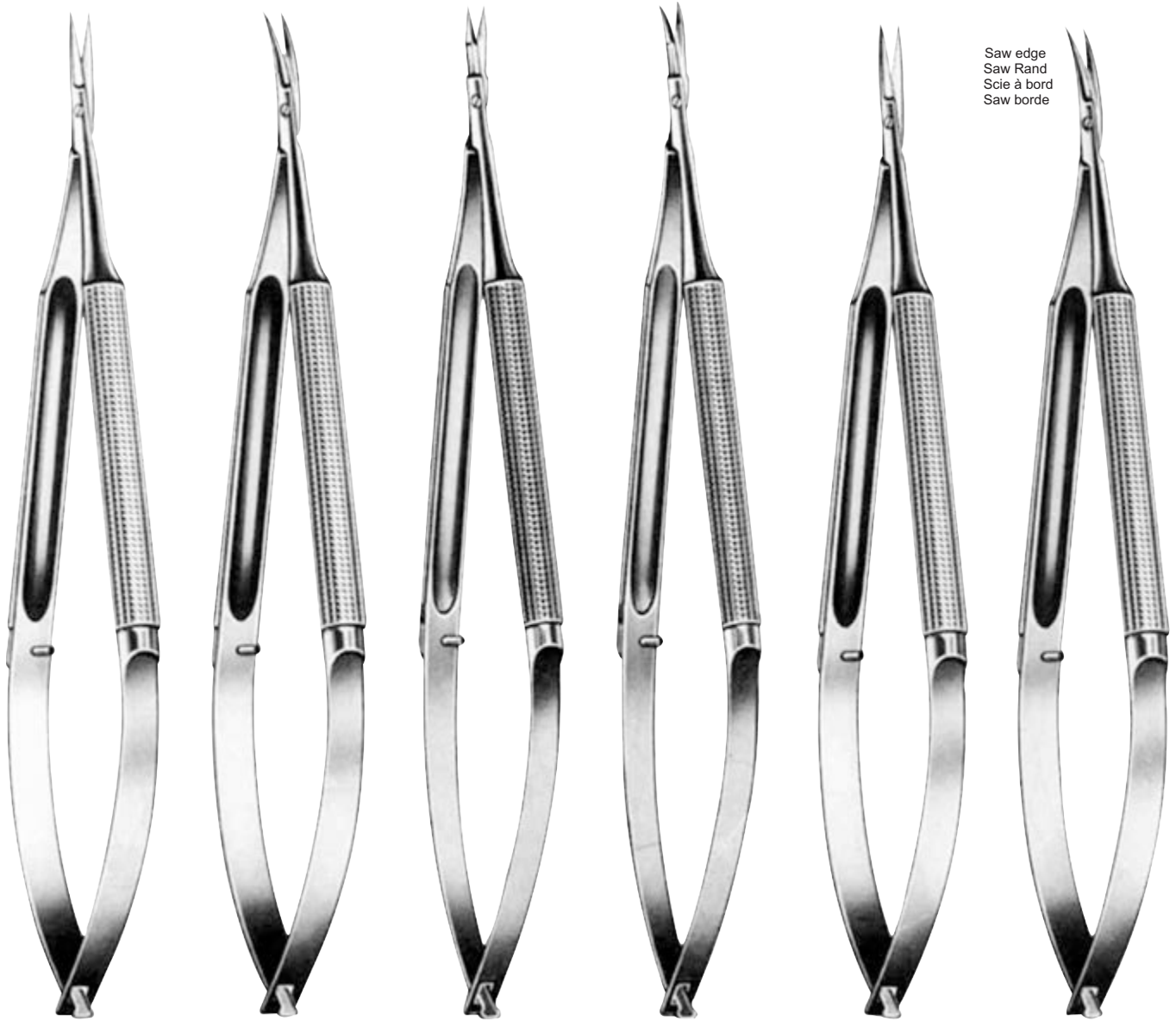

Saw edge
Saw Rand
Scie à bord
Saw borde

02-0414-16
16cm/6¼"

Striight
striight
striight
striight

02-0415-16
16cm/6¼"

Curved
Gebogene
courbé
Curvo

02-0416-16
16cm/6¼"

Striight
striight
striight
striight

02-0417-16
16cm/6¼"

Curved
Gebogene
courbé
Curvo

02-0418-16
16cm/6¼"

Striight
striight
striight
striight

02-0419-16
16cm/6¼"

Curved
Gebogene
courbé
Curvo

General Instruments

Micro Scissors
Micro Scissors

Ciseaux Micro
Micro Tijeras



02-0420-18
18.5cm/7¼"
Striaht
striaht
striaht
striaht

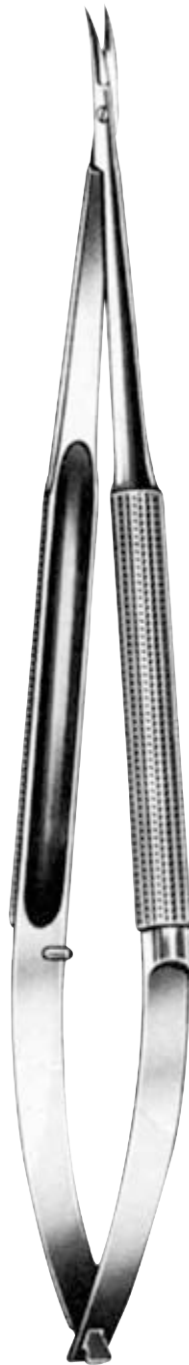

02-0421-18
18.5cm/7¼"
Curved
Gebogene
courbé
Curvo

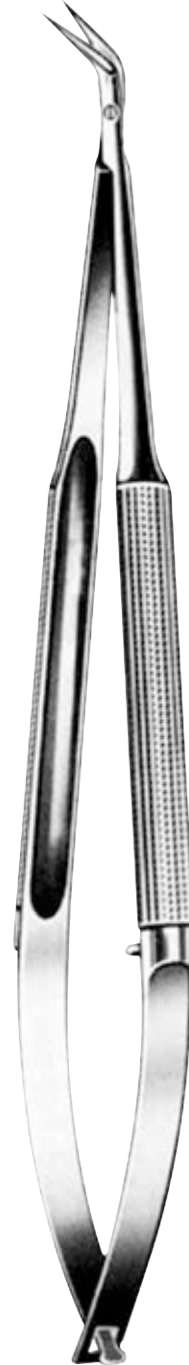

02-0422-18
18.5cm/7¼"
Angular
Angled
incliné

General Instruments

Micro Scissors
Micro Scissors

Ciseaux Micro
Micro Tijeras

02



Dissecting Scissors
Präparier schere
Ciseaux à dissection
Tijeras de disección



02-0423-14
14 cm/5 1/2"

Straight
straight
straight
straiight

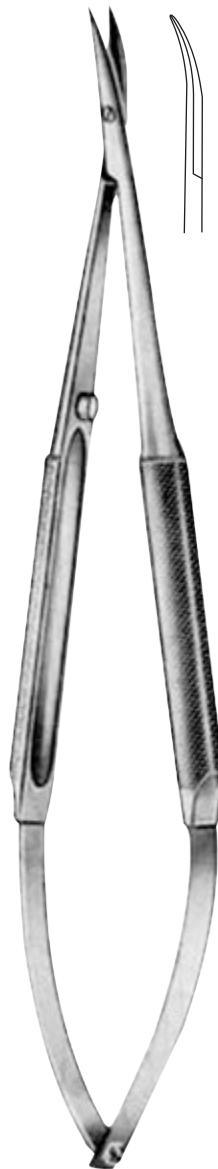

02-0424-14
14 cm/5 1/2"

Curved
Gebogene
courbé
Curvo

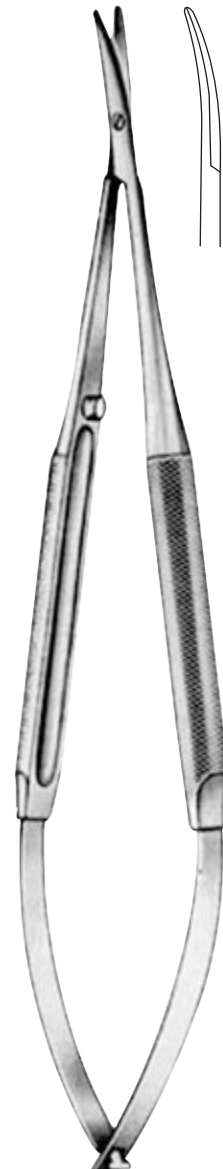

02-0425-14
14 cm/5 1/2"

Curved
Gebogene
courbé
Curvo

General Instruments

Eye and Fine Scissors
Augen-und einer feinen Schere

Des yeux et des ciseaux fins
Los ojos y tijeras finas



02-0426-12
Striight
striight
striight
striight

12cm/4¾"



02-0427-12
Curved
Gebogene
courbé
Curvo



11.5cm/4½"



02-0428-11



02-0430-11



02-0429-11



02-0431-11



Knapp
10.5cm/4¼"



02-0432-10



02-0434-10



02-0436-10



02-0433-10



02-0435-10



02-0437-10



02-0438-11
Striight
striight
striight
striight

11.5cm/4½"



02-0439-11
Curved
Gebogene
courbé
Curvo

General Instruments

Eye Scissors
Augenschere

Ciseaux Eye
Tijeras del ojo



02



Striaight
striaight
striaight
striaight

Standard



Curved
Gebogene
courbé
Curvo



9.0 cm/3½"	02-0440-09	02-0441-09	02-0442-09	02-0443-09
10.5 cm/4¼"	02-0440-10	02-0441-10	02-0442-10	02-0443-10
11.5 cm/4½"	02-0440-11	02-0441-11	02-0442-11	02-0443-11



Striaight
striaight
striaight
striaight

Fine



Curved
Gebogene
courbé
Curvo

Fine



Striaight
striaight
striaight
striaight



Curved
Gebogene
courbé
Curvo

9.0cm/3½"			02-0446-09	02-0447-09
10.5cm/4¼"	02-0444-10	02-0445-10	02-0446-10	02-0447-10
11.5cm/4½"	02-0444-11	02-0445-11	02-0446-11	02-0447-11

General Instruments

Eye Scissors
Augenschere

Ciseaux Eye
Tijeras del ojo



02-0448-10 10cm/4" 02-0449-10

Striaght
striaght
striaght
striaght

Curved
Gebogene
courbé
Curvo



Fine
9.5 cm/3¾"
10.5 cm/4¼"
11.5 cm/4½"

02-0450-09
02-0450-10
02-0450-11
Striaght
striaght
striaght
striaght



Fine
02-0451-09
02-0451-10
02-0451-11

Curved
Gebogene
courbé
Curvo

Tenotomy Scissors
Tenotomie Schere
Ciseaux ténotomie
Tijeras tenotomía



Stevens
10.5cm/4¼"
11.5cm/4½"



Pointed
spitz
pointu
apuntado

02-0452-10
02-0452-11

Striaght
striaght
striaght
striaght



02-0453-10
02-0453-11

Curved
Gebogene
courbé
Curvo



Blunt
blunt
blunt
blunt

02-0454-10
02-0454-11

Striaght
striaght
striaght
striaght



02-0455-10
02-0455-11

Curved
Gebogene
courbé
Curvo



02-0456-08
Striaght
striaght
striaght
striaght



Bonn
8cm/3¼" 02-0457-08
Curved
Gebogene
courbé
Curvo

General Instruments

Eye Scissors
Augenschere

Ciseaux Eye
Tijeras del ojo



02



Graefe
02-0458-10
10.5cm/4¼"



Wilmer
02-0459-10
10cm/4"



02-0460-11

11.5cm/4½"



02-0461-11



02-0462-11
Striaght
striaght
striaght
striaght

11.5cm/4½"



02-0463-11
Curved
Gebogene
courbé
Curvo



La Grange
02-0464-11
11.5cm/4½"



Chadwick
02-0465-11
11cm/4½"

General Instruments

Dissecting and Neurosurgical Scissors
Anatomische und Neurochirurgische Schere

Dissection et Ciseaux de neurochirurgie
Tijeras de disección y Neurocirugía

Neurosurgical Scissors



Striaght
striaght
striaght
striaght

02-0466-11 11cm/4½"
02-0466-13 13cm/5"



Curved
Gebogene
courbé
Curvo

02-0467-11
02-0467-13



Potts-de Martel
02-0468-21
21cm/8¼"



Mills
02-0469-21
21cm/8¼"



Dura Scissors
Dura Tijeras
Ciseaux Dura
Dura Tijeras

Schmieden-Taylor
02-0470-14 14 cm/5½"
02-0470-17 17.0cm/6 "



Strully
02-0471-22 22cm/8¾"



02-0472-22



Dandy
02-0473-17
17cm/6¾"

General Instruments

Ligature Scissors
Ligature Schere

Ciseaux Ligatures
Tijeras de ligadura

02



Spencer
02-0474-09
9cm/3½"



Spencer
02-0475-10 10.5cm/4¼"
02-0475-12 12.0cm/4¾"



Spencer-Fine
02-0476-11 11.5cm/4½"
02-0476-16 16cm/6¼"



Littauer
02-0477-14
14cm/5½"



Shortbent
02-0478-09
9cm/3½"



Northbent
02-0479-12
12.5cm/5"



Spencer
02-0480-11
11.5cm/4½"



Littler
02-0481-11
11.5cm/4½"

General Instruments

Ligature Scissors
Ligature Schere

Ciseaux Ligatures
Tijeras de ligadura



Heath
02-0482-15
15cm/6"



02-0483-10
10cm/4"



Eiselsberg
02-0484-11
11.5cm/4½"



Schoemaker-Loth
02-0485-12
12.5cm/5"

Wire Cutting Scissors
Ciseaux de coupe de fil
Tijeras de corte de alambre



Universal
02-0486-12
12cm/4¾"

Saw edge
Saw Rand
Scie à bord
Saw borde

General Instruments

Bandage and Wire Cutting Scissors
 Bandage und Draht Schneidescheren

Bandage et Ciseaux de coupe de câbles
 Vendaje y tijeras de corte de alambre



02

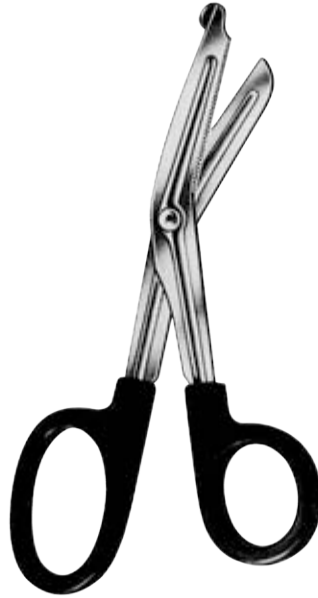

	Universal	Universal	Universal
Black	02-0487-01	02-0488-01	02-0489-01
Blue	02-0487-02	02-0488-02	02-0489-02
Red	02-0487-03	02-0488-03	02-0489-03
Green	02-0487-04	02-0488-04	02-0489-04

14.5 cm/5¾"

16 cm/6¼"

18 cm/7"

Other Colour Available



Smith
 02-0490-17
 17.5 cm/7"



Harvey
 02-0491-12
 12.5 cm/5"

Saw edge
 Saw Rand
 Scie à bord
 Saw borde



Schuknecht
 02-0492-10
 10 cm/4"

Saw edge
 Saw Rand
 Scie à bord
 Saw borde



02-0493-13 13 cm/5"
 02-0493-15 15 cm/6"

General Instruments

Bandage Scissors
Verbandschere

Ciseaux à pansements
Tijeras de vendaje



Lister

02-0494-09 9 cm/3½"
02-0494-13 13 cm/5"
02-0494-14 14 cm/5½"
02-0494-18 18 cm/7"
02-0494-20 20 cm/8"



Lister

02-0495-18
18 cm/7"



Lister

02-0496-18 18.5 cm/7¼"
02-0496-21 20 cm/8"



Lister-Excentric

02-0497-16 16 cm/6¼"
02-0497-19 19 cm/7½"



Esmarch

02-0498-20 20 cm/8"
02-0498-22 22 cm/8¾"



Bergmann

02-0499-23
23 cm/9"



Lorenz

02-0500-23
23 cm/9"

General Instruments

Bandage Scissors
Verbandschere

Ciseaux à pansements
Tijeras de vendaje

02



Saw edge
Saw Rand
Scie à bord
Saw borde

02-0501-17
17 cm/6¾"



Lange
02-0502-18
18 cm/7"



Bruns
02-0503-01 24 cm/9½" Saw edge
02-0503-02 24 cm/9½" Smooth
02-0503-03 24 cm/9½" Smooth



Smith (Mod. USA)
02-0504-16 16 cm/6¼"
02-0504-18 18 cm/7"
02-0504-20 20 cm/8"
02-0504-23 23 cm/9"



Knowles
02-0505-14
14 cm/5½"



Knowles
02-0506-14
14 cm/5½"



02-0507-13
13 cm/5"

General Instruments

Clothing Scissors, Plaster of Paris and Rib Shears
Bekleidung Schere, Plaster of Paris und Rib Shears

Ciseaux Vêtements, plâtre de Paris et costotome
Tijeras de ropa, yeso y tijeras costales



02-0508-20
20 cm/8"



Seutin
02-0509-23
23 cm/9"



Bone Shear
02-0510-23
23 cm/9"



02-0511-22
22 cm/8¾"



Gluck
02-0512-22
22 cm/8¾"



Stille
02-0513-21
21 cm/8¼"



Stille
02-0514-24
24 cm/9½"

General Instruments

Plaster of Paris & Rib Shears
Plaster of Paris & Rib Shears

Plâtre de Paris et costotome
Yeso de París y cizallas Rib



02



Stille

02-0515-23 23 cm/9"
02-0515-26 26 cm/10¼"
02-0515-37 37 cm/14½"



02-0516-23 23cm/9"
02-0516-26 26cm/10¼"
02-0516-37 37cm/14½"



Maurer collin

02-0517-24L 24 cm/9½"
02-0517-30L 30 cm/12"
02-0517-24R 24 cm/9½"
02-0517-30R 30 cm/12"

General Instruments

Crown Scissors
Crown Schere

Ciseaux de la Couronne
Corona Tijeras

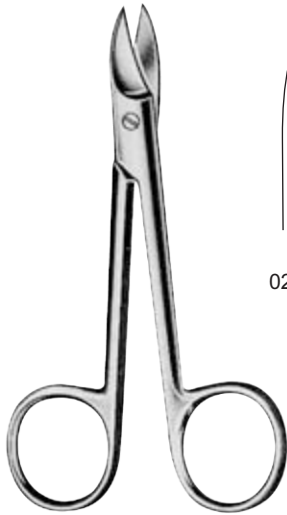

Blunt
02-0518-10
Blunt
blunt
blunt
blunt

Pointed
02-0519-10
Pointed
spitz
pointu
apuntado

Beebee
10.5 cm/4 1/4"
Striight
striight
striight
striight



Blunt
02-0520-10
Blunt
blunt
blunt
blunt

Pointed
02-0521-10
Pointed
spitz
pointu
apuntado

Beebee
10.5 cm/4 1/4"
Curved
Gebogene
courbé
Curvo



02-0522-10
10.5 cm/4 1/4"



Beebee
12 cm/4 3/4"

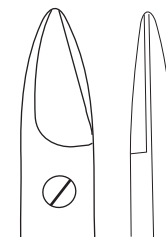

02-0523-12
Striight
striight
striight
striight

Saw edge
Saw Rand
Scie à bord
Saw borde

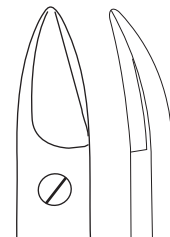

02-0524-12
Curved
Gebogene
courbé
Curvo

General Instruments

Gum Scissors
Gum Schere

Ciseaux Gum
Tijeras de las encías

02



Goldmann-Fox
02-0525-13
13 cm/5"



Goldmann-Fox
02-0526-13
13 cm/5"



Niro
02-0527-14
14 cm/5½"



Goldmann-Fox
(Spezial)
02-0528-13
13 cm/5"

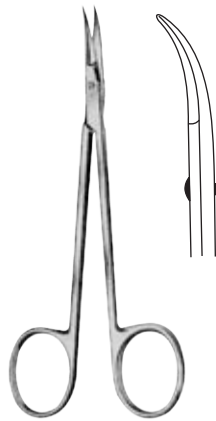

02-0529-11
11.5 cm/4½"



Fine
fein
fin
multa



Quinby
02-0530-12
12 cm/4¾"



Quinby
02-0531-12
12 cm/4¾"

General Instruments

Gum Scissors
Gum Schere

Ciseaux Gum
Tijeras de las encías



Saw edge
Saw Rand
Scie à bord
Saw borde

Dean
02-0532-17
17 cm/6¾"



Dean
02-0533-17
17 cm/6¾"



Saw edge
Saw Rand
Scie à bord
Saw borde

Locklin
02-0534-16
16.5 cm/6½"



Locklin
02-0535-16
16.5 cm/6½"



Sullivan
02-0536-14
14 cm/5½"



Sullivan
02-0537-14
14 cm/5½"



Neumann
02-0538-12
12 cm/5"



La Grange
02-0539-12
11 cm/4 1/2"

General Instruments

Gum and Nail Scissors Ciseaux Gum et ongles
 Gum-und Nagelscheren Las encías y uñas Tijeras



02

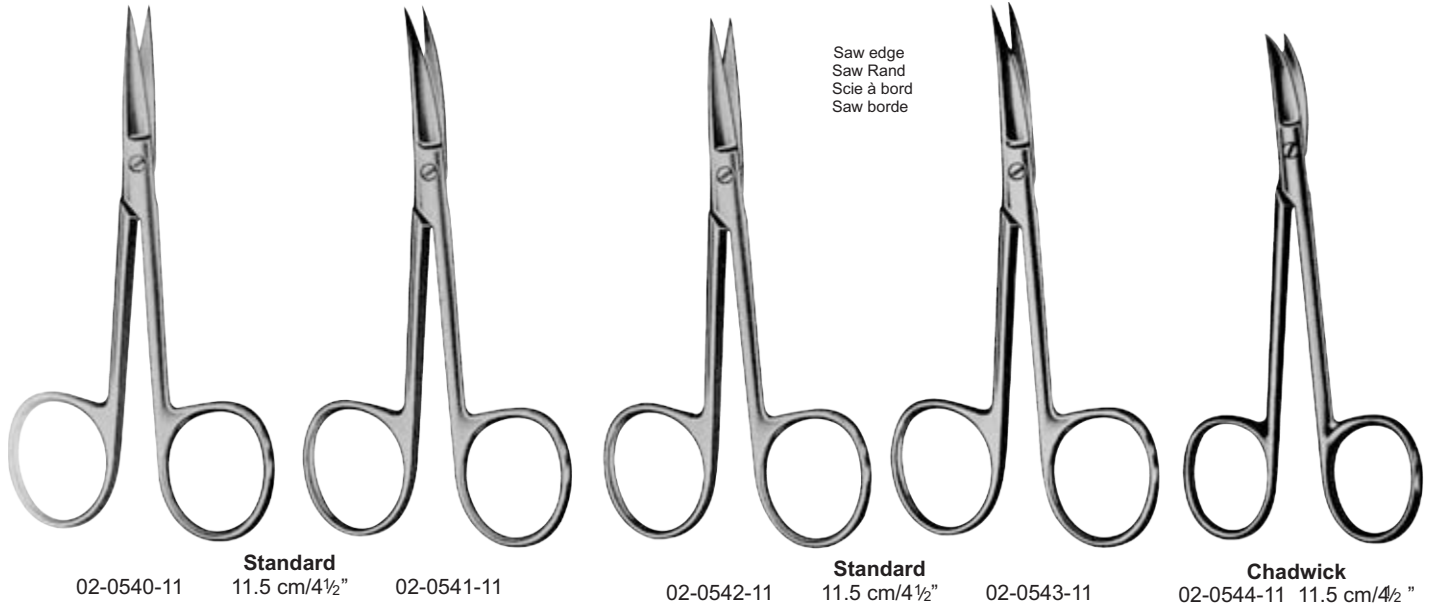

Nail scissors
 Nagelschere
 ciseaux à ongles
 tijeras para las uñas



General Instruments

Dressing Forceps
Kornzangen

pinces à pansement
Pinzas de Vestir

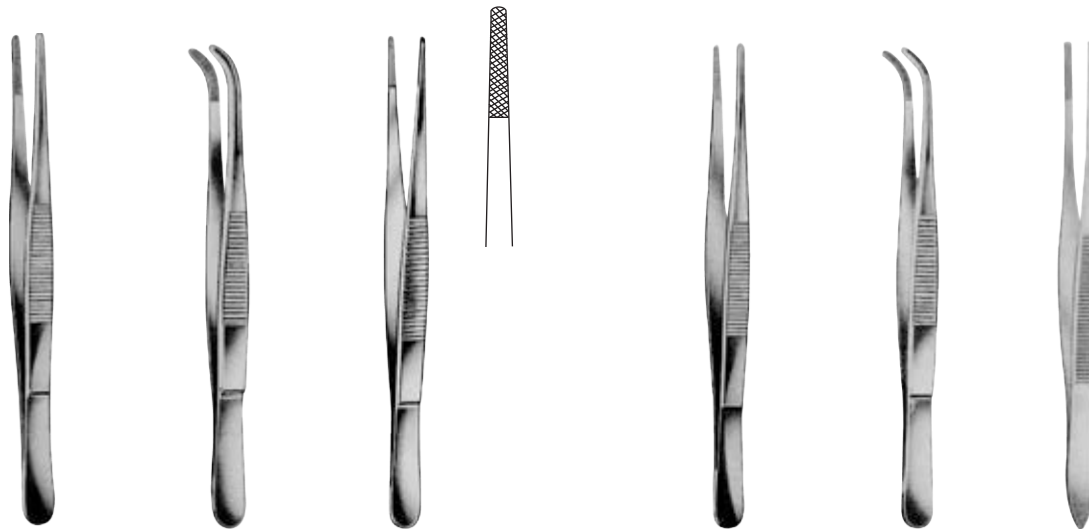

cm	in	Standard	Standard	Standard			Stille
10.5	4 1/4"	03-0550-10					
11.5	4 1/2"	03-0550-11	03-0551-11		03-0553-11	03-0554-11	
13.0	5"	03-0550-13	03-0551-13		03-0553-13	03-0554-13	03-0555-13
14.0	5 1/2"	03-0550-14	03-0551-14	03-0552-14	03-0553-14	03-0554-14	
15.0	6"	03-0550-15					03-0555-15
16.0	6 1/4"	03-0550-16	03-0551-16	03-0552-16	03-0553-16	03-0554-16	
18.0	7"	03-0550-18	03-0551-18	03-0552-18	03-0553-18	03-0554-18	03-0555-18
20.0	8"	03-0550-20		03-0552-20	03-0553-20		03-0555-20
25.0	10"	03-0550-25		03-0552-25	03-0553-25		
30.0	12"	03-0550-30			03-0553-30		

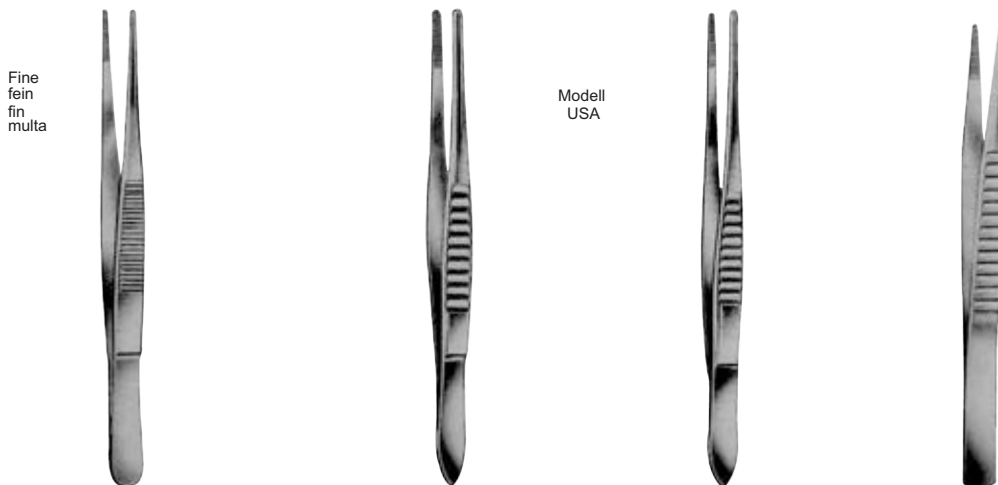

Fine
fein
fin
multa

Modell
USA

cm	in	Standard	Narrow	Engl. Modell
11.5	4 1/2"	03-0556-11		
12.0	4 3/4"		03-0557-12	03-0558-12
13.0	5"	03-0556-13	03-0557-13	03-0559-13
14.0	5 1/2"	03-0556-14	03-0557-14	03-0558-14
15.0	6"	03-0556-15	03-0557-15	03-0559-15
16.0	6 1/4"	03-0556-16	03-0557-16	
18.0	7"	03-0556-18	03-0557-18	
20.0	8"	03-0556-20	03-0557-20	
21.0	8 1/4"		03-0557-25	
25.0	10"		03-0557-30	
30.0	12"			

General Instruments

Dressing Forceps
Kornzangen

pincès à pansement
Pinzas de Vestir

03

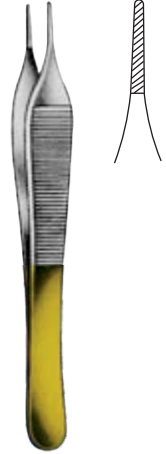
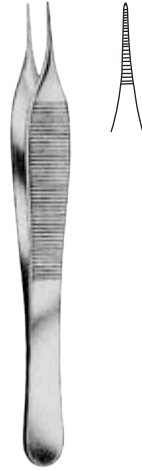

cm	in	Ewald
12.0	4¾"	03-0560-12
15.5	6"	03-0560-15

Jacobson-Adson
03-0561-12
03-0561-15

Micro-Adson
03-0562-12
03-0562-15

Adson-Standard
03-0563-12
03-0563-15

Adson
03-0564-12
03-0564-15



cm	in	McIndoe
12.0	4¾"	
15.0	6"	03-0565-15

McIndoe
03-0566-15

Semken	
03-0567-12	03-0568-12
03-0567-15	03-0568-15

Semken
03-0569-12
03-0569-15

General Instruments

Dressing Forceps
Kornzangen

pinces à pansement
Pinzas de Vestir



03-0570-17



03-0571-17



Taylor
03-0572-17
17.5cm/7"



03-0573-17



03-0574-17

Smooth Jaw
glatte Jaw
Moose lisse
Jaw Smooth



cm	in	Waugh		Bonney	Brophy	Brophy
15.0	6"	03-0575-15				
18.0	7"	03-0575-18	03-0576-18	03-0578-18		
20.0	8"	03-0575-20	03-0576-20		03-0579-18	03-0580-18

General Instruments

Micro Forceps
Mikropinzette

Micro Pince
Micro Pinzas



03



Curved
Gebogene
courbé
Curvo



Gerald

cm	in						
12.0	4¾"			03-0584-12	03-0585-12		
13.0	5"	03-0582-13	03-0583-13				
15.0	6"	03-0581-15		03-0584-15	03-0585-15		
17.5	7"					03-0586-17	03-0587-17
18.0	7"	03-0581-18		03-0584-18	03-0585-18		

Micro Tubal Forceps
Micro Forceps Tubal
Micro Pinzas de trompas

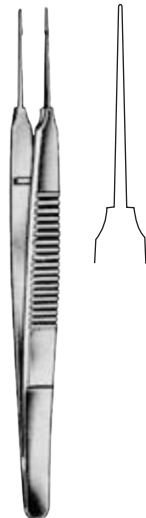

Austin
03-0588-14
14cm/5½"

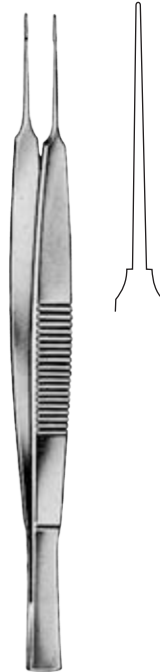

Austin
03-0589-18
18cm/7"



Neubuser
03-0590-20
20cm/8"

General Instruments

 Dressing Forceps
 Kornzangen

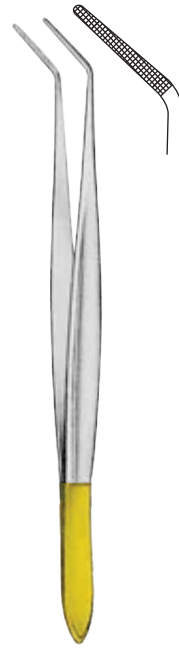
 pinces à pansement
 Pinzas de Vestir

cm	in	Cushing	Cushing	Cushing	Cushing	Cushing-Taylor	Grunwald
18.0	7	03-0591-18	03-0592-18	03-0593-18	03-0594-18	03-0595-18	03-0596-18



cm	in	Wangensteen		Potts-Smith			
15.0	6"	03-0597-15					
18.0	7"		03-0598-18	03-0599-18	03-0600-18	03-0601-15	03-0601-18
20.0	8"			03-0599-21			
21.0	8 1/4"			03-0599-25	03-0600-21	03-0601-20	03-0601-23
23.0	9"	03-0597-23	03-0598-23				
25.0	10"	03-0597-25			03-0600-25	03-0601-25	

General Instruments

Tissue Forceps
Pinzette

Pince de tissus
Pinzas de tejido



03



cm	in	Standard 1:2	Oehler 1:2	Standard 2:3	Standard 3:4	Standard 4:5	1:2
10.5	4¼"	03-0602-10					
11.5	4½"	03-0602-11					
13.0	5"	03-0602-13		03-0604-13	03-0605-13	03-0606-13	03-0607-13
14.0	5½"	03-0602-14	03-0603-14	03-0604-14	03-0605-14	03-0606-14	03-0607-14
15.0	6"	03-0602-15					
16.0	6¼"	03-0602-16	03-0603-16	03-0604-16	03-0605-16	03-0606-16	03-0607-16
18.0	7"	03-0602-18	03-0603-18	03-0604-18			03-0607-18
20.0	8"	03-0602-20	03-0603-20	03-0604-20			03-0607-20
25.0	10"	03-0602-25	03-0603-25	03-0604-25			03-0607-25
30.0	12"	03-0602-30	03-0603-30	03-0604-30			

General Instruments

 Tissue Forceps
 Pinzette

 Pince de tissu
 Pinzas de tejido

 Modell
 USA

 Modell
 USA

 Modell
 USA

 Narrow
 schmal
 étroit
 estrecho

Standard

cm	in	1:2	2:3	3:4	1:2
12.0	4 ³ / ₄ "	03-0608-12	03-0609-12		
13.0	5"	03-0608-13	03-0609-13		03-0611-13
14.0	5 ¹ / ₂ "	03-0608-14	03-0609-14	03-0610-14	03-0611-14
15.5	6"	03-0608-15			03-0611-15
18.5	7 ¹ / ₄ "	03-0608-18	03-0609-18		
21.0	8 ¹ / ₄ "	03-0608-21	03-0609-21		
25.0	10"	03-0608-25	03-0609-25		
31.0	12 ¹ / ₄ "	03-0608-31	03-0609-31		

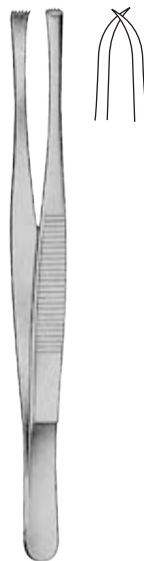
Lerche

Stone

Treves

cm	in	Lerche	Stone	Treves
13.0	5"			03-0614-13
15.0	6"	03-0612-15	03-0613-15	03-0614-15

General Instruments

Tissue Forceps
Pinzette

Pince de tissu
Pinzas de tejido

03

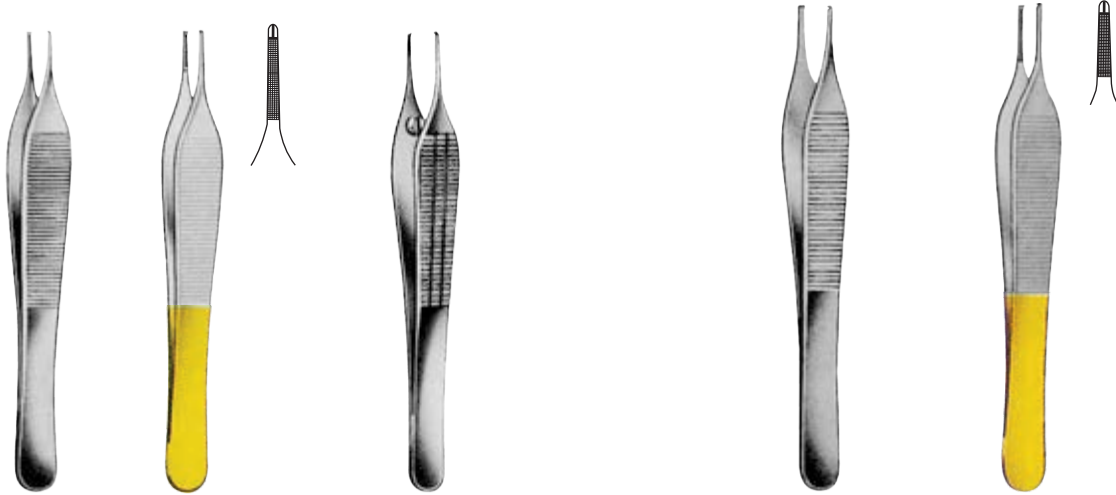

cm	in	Micro-Adson			Ewald	Standard-Adson
12.0	4¾"	03-0615-12	03-0616-12	03-0617-12	03-0618-12	03-0619-12
15.5	6"	03-0615-15	03-0616-15	03-0617-15		03-0619-15

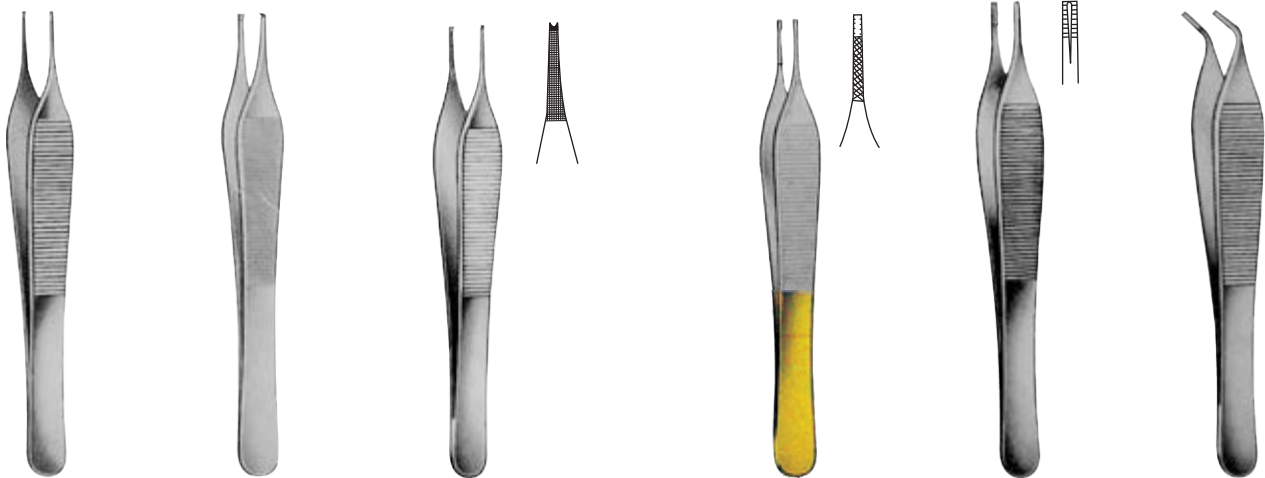

cm	in	Adson			Adson-Brown		
12.0	4¾"	03-0620-12	03-0621-12	03-0622-12	03-0623-12	03-0624-12	03-0625-12
15.0	6"	03-0620-15	03-0621-15				

General Instruments

Tissue Forceps
Pinzette

Pince de tissu
Pinzas de tejido



Gillies
03-0626-15 15 cm/6"



Gillies
03-0627-15 15 cm/6"



Brown
03-0628-15 15 cm/6"
03-0628-20 20 cm/8"
03-0628-25 25 cm/10"



Semken
03-0629-12 12 cm/4¾" 03-0630-12
03-0629-15 15 cm/6" 03-0630-15



Adlerkreutz
03-0631-15 15 cm/6"
03-0631-20 20 cm/8"
03-0631-25 25 cm/10"



Adlerkreutz
03-0632-15 15 cm/6"
03-0632-20 20 cm/8"
03-0632-25 25 cm/10"



Taylor
03-0633-17 17.5 cm/7"



Taylor
03-0634-17 17.5 cm/7"



Taylor
03-0635-17 17.5 cm/7"



Taylor
03-0636-17 17.5 cm/7"

General Instruments

Tissue Forceps
Pinzette

Pince de tissus
Pinzas de tejido

03

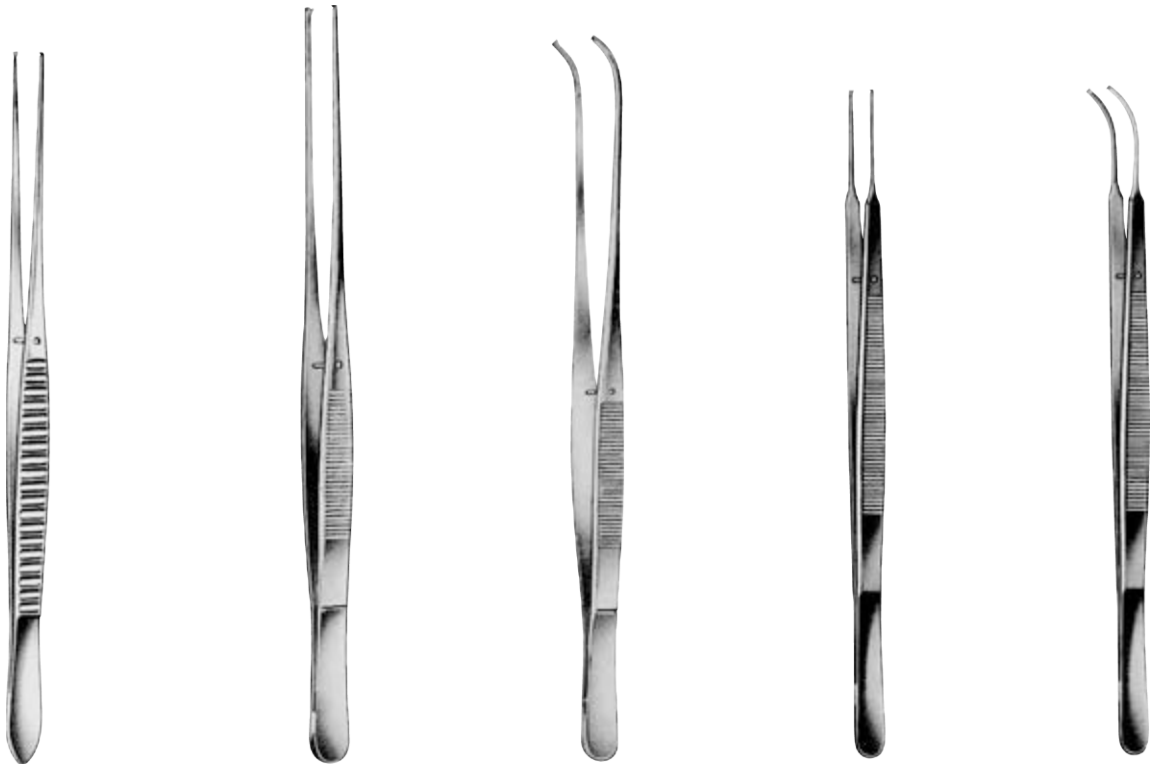

cm	in	Waugh	Brophy	Brophy	Gerald	Gerald
15	6"	03-0637-15				
18	7"	03-0637-18			03-0640-18	03-0641-18
20	8"	03-0637-20	03-0638-20	03-0639-20		

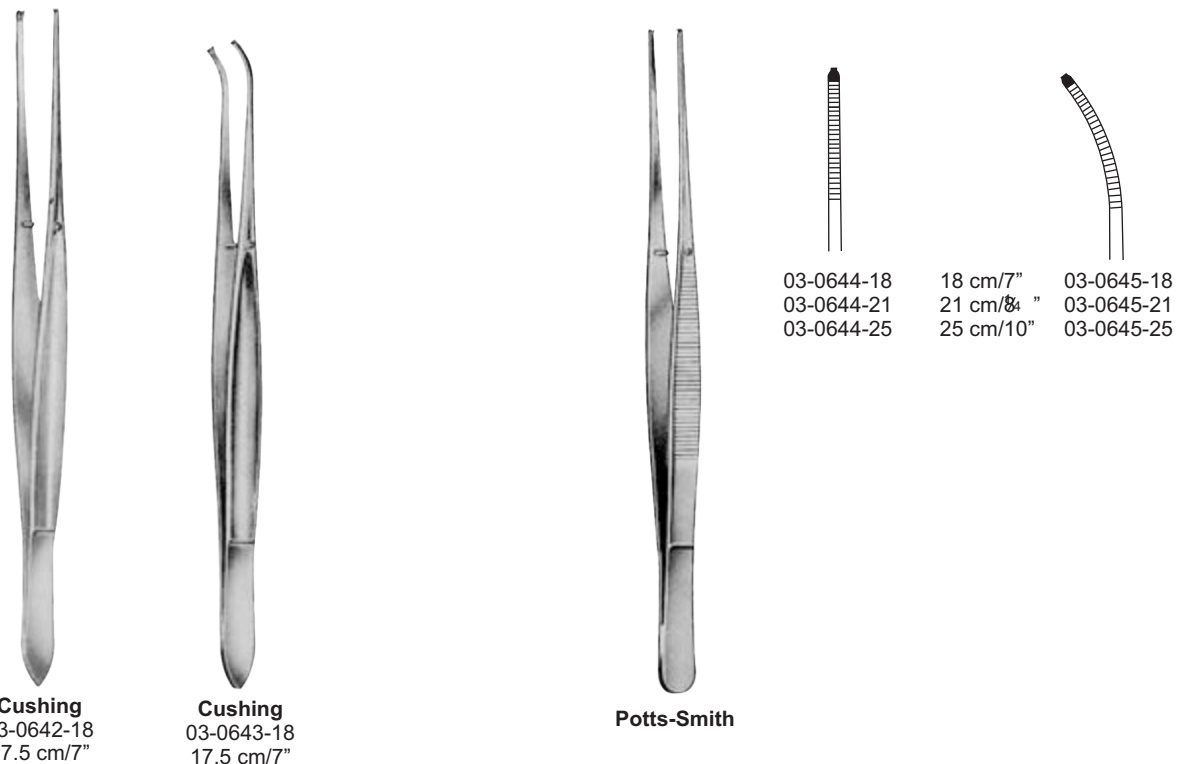

Cushing
03-0642-18
17.5 cm/7"

Cushing
03-0643-18
17.5 cm/7"

Potts-Smith

03-0644-18
03-0644-21
03-0644-25

18 cm/7"
21 cm/8 1/4"
25 cm/10"

03-0645-18
03-0645-21
03-0645-25

General Instruments

Fine and Splinter Forceps
Fein-und Splitter-Zange

Pinces fines et Splinter
Unas pinzas finas y Splinter



With Pin
mit Pin
avec Pin
Con Pin



cm in
10.5 4 1/4" 03-0646-10

03-0647-10

Graefe
03-0648-10

03-0649-10

03-0650-10

03-0651-10



cm in
9.0 3 1/2" 03-0652-09
10.5 4 1/4" 03-0652-10
11.5 4 1/2" 03-0652-11
12.5 5" 03-0652-12

03-0653-09
03-0653-10
03-0653-11
03-0653-12

03-0654-09
03-0654-10
03-0654-11
03-0654-12

03-0655-09
03-0655-10
03-0655-11
03-0655-12

General Instruments

Tissue and Grasping Forceps
Gewebe- und Faszange

Tissus et Pincés à préhension
Tejidos y pinzas de agarre



03



Duval
03-0656-14 14.5 cm/5½"

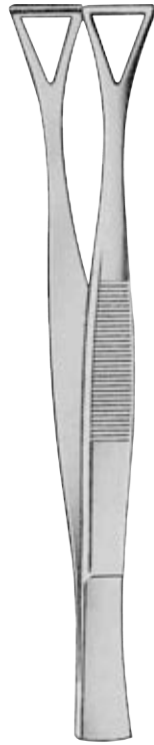

Collin-Duval
03-0657-20 20 cm/8"



Durante
03-0658-14 14.5 cm/5¾"
03-0658-16 16.0 cm/6¼"
03-0658-20 20.0 cm/8"



Russ. Modell
03-0659-15 15 cm/6"
03-0659-20 20 cm/8"
03-0659-25 25 cm/10"



Mayo
03-0660-23 23 cm/9"



Ferris-Smith
18 cm/7"

03-0661-18



03-0662-18



Ramsay
03-0663-17 17.5cm/7"



Lane
03-0664-12 12 cm/5"
03-0664-15 15cm/6"
03-0664-18 18cm/7"



03-0665-12
03-0665-15
03-0665-18

General Instruments

Tissue Grasping and Watchmakers Forceps
Tissue Greifen und Uhrmacher Pinzetten

Saisir des tissus et de l'horlogerie Pince
Tejido Pinzas de presión y Relojeros

03

Grasping Forceps
Fasszange
pince à préhension
pinzas de agarre



cm	in	Stille-Barraya	Bonney	Bonney	Nelson	Singley-Tuttle
15.0	6"				03-0669-15	
18.0	7"	03-0666-18	03-0667-18	03-0668-18	03-0669-18	03-0670-18
20.0	8"	03-0666-20			03-0669-23	
23.0	9"					03-0670-23
25.0	10"	03-0666-25				



No. 3
03-0671-03
11.5cm/4½"



No. 4
03-0672-04
11.5cm/4½"



No. 5
03-0673-05
11.5cm/4½"

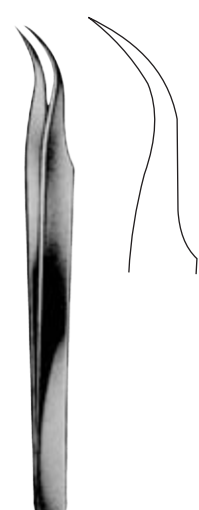

No. 7
03-0674-07
11.5cm/4½"

Watchmakers Forceps
Uhrmacher Pinzette
horlogers Pincas
Relojeros Pinzas

General Instruments

Splinter Forceps
Splitter-Zange

Pincès à échardes
Pinzas de Splinter



03



Feilchenfeld

- 03-0675-07 7.5cm/3"
- 03-0675-09 9.0cm/3½"
- 03-0675-11 11.5cm/4½"



Hunter

- 03-0676-10 10.5cm/4¼"
- 03-0677-10



Walter-Carmalt

- 03-0678-10 10.5cm/4¼"
- 03-0679-10



Peet

- 03-0680-11 11.5cm/4 1/2"



- 03-0681-13 with out ratchet
- 03-0682-13 with ratchet



03-0683-13
13cm/5¼"
45°



03-0684-13
13cm/5¼"
90°



Ralk

- 03-0685-15 15cm/6"



Ralk

- 03-0686-15 15cm/6"

General Instruments

Ligature and Cilia Forceps
Ligature und Cilia Forceps

Pince de ligature et Cilia
Ligadura y Cilia Pinzas



Ochsner
03-0687-14
14.5cm/5¾"



Adson
03-0688-12
12cm/4¾"



Adson
03-0689-12
12cm/4¾"

Cilia Forceps
Cilia Forceps
Pince à cils
Pinzas Cilia



Beaupre
03-0690-12
12cm/4¾"



Henry
03-0691-12
12cm/4¾"



Gradle
03-0692-09
9.5cm/3¾"



Barraquer
03-0693-10
10.5cm/4¼"



Bennett
03-0694-07
7cm/2¾"

General Instruments

Silia and Cover Glass Forceps
Silia und Deckglaspinzetten

Silia et Pince verre de couverture
Silia y el Pinzas Cubierta de vidrio



03



cm in **Beer**
9.0 3½" 03-0695-09

Douglo
03-0696-09

Ziegler
03-0697-09

03-0698-09

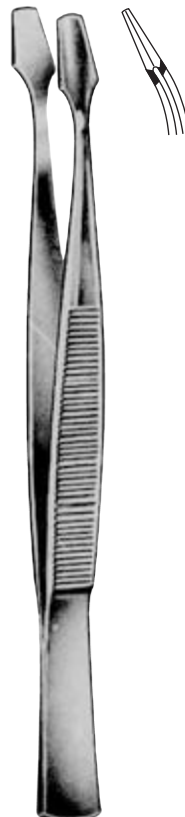
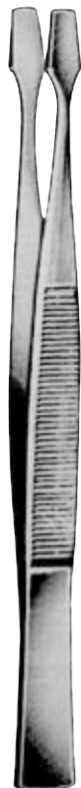

Kuehne
03-0699-10
10.5cm/4¼"

Kuehne
03-0700-10
10.5cm/4¼"

03-0701-10
10.5cm/4¼"

General Instruments

Atrauma Tissue Dressing and Nasal Dressing Forceps
 Atrauma Tissue Dressing und Tupferzange

Vinaigrette tissu nasaux et atraumatique pinces à pansement
 Atrauma Aderezo de tejidos y Pinzas nasales Vestir

03



Debaquey

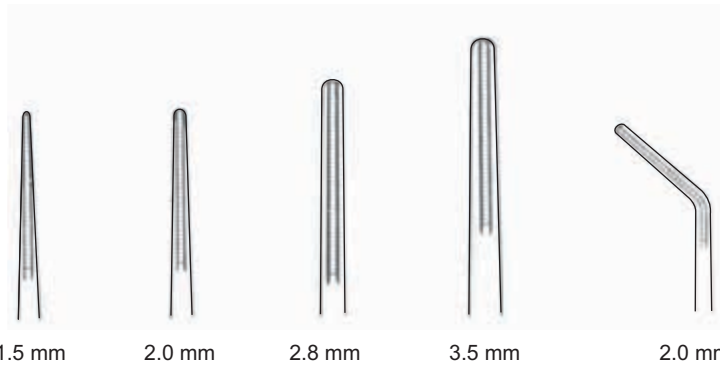

1.5 mm 2.0 mm 2.8 mm 3.5 mm 2.0 mm

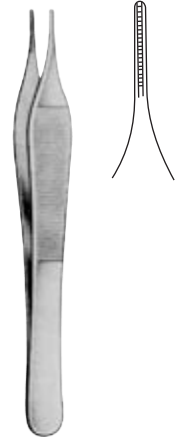

Adson

03-0707-12 12cm/4¾"
 03-0707-15 15cm/6"

cm	in	1.5 mm	2.0 mm	2.8 mm	3.5 mm	2.0 mm
16.0	6¼"	03-0702-16	03-0703-16	03-0704-16	03-0705-16	03-0706-16
20.0	8"	03-0702-20	03-0703-20	03-0704-20	03-0705-20	03-0706-20
24.0	9½"	03-0702-24	03-0703-24	03-0704-24	03-0705-24	03-0706-24
30.0	12"	03-0702-30	03-0703-30	03-0704-30	03-0705-30	03-0706-30



**Troeltsch
(Wilde)**

11.5 4½" 03-0708-11
 12.0 4¾" 03-0708-12
 14.0 5½" 03-0708-15
 15.0 6" 03-0708-15
 16.0 6¼" 03-0708-18
 18.0 7" 03-0708-18
 20.0 8" 03-0708-18



Troeltsch

03-0709-12



Lucae

03-0710-14



Lucae

03-0711-14



**Jansen
(Gruenwald)**

03-0712-16
 03-0712-18
 03-0712-20



Jansen

03-0713-16
 03-0713-18
 03-0713-20

General Instruments

Atraumatic Dressing Forceps, Dessicating Forceps
Atrauma Tissue Dressing und Tupferzange

Vinaigrette tissus nasaux et atraumatique pincés à pansement
Atrauma Aderezo de tejidos y Pinzas nasales Vestir



03



JOBOMA

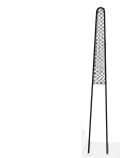

03-0714-18 18 cm/ 7"



JOBOMA



03-0715-18 18 cm/ 7"



1: 2



JOBOMA

03-0716-18 18 cm/ 7"



1: 2

General Instruments

Micro Dressing Forceps
Micro Kornzange

Micro pince à pansement
Micro Pinza Dressing



1/2



Titanium

	cm in		6,0 x 0,4 mm		6,0 x 0,7 mm		6,0 x 0,8mm	
Steel	15	6"	03-0717-15	03-0718-15	03-0719-15	03-0720-15		
Titanium	15	6"	03-0717-15	03-0718-15			03-0721-15	03-0722-15
Steel	18	7"	03-0717-18	03-0718-18	03-0719-18	03-0720-18		
Titanium	18	7"	03-0717-18	03-0718-18			03-0721-15	03-0722-18
Steel	21	8 1/4"			03-0719-21	03-0720-21		
Titanium	21	8 1/4"	03-0717-21	03-0718-21			03-0721-21	03-0722-21
Steel	23	9"			03-0719-23	03-0720-23		

General Instruments

Micro Dissecting Forceps
Micro Dissektionszangen

Micro Pince à dissection
Micro Pinza de disección















03



1/2



1/2

	Tips Tipps conseils consejos							
	cm	in	6,0 x 0,4 mm  1:2	6,0 x 0,4 mm  1:2	6,0 x 0,7 mm  1:2	6,0 x 0,7 mm  1:2	6,0 x 0,8 mm  1:2	6,0 x 0,8 mm  1:2
Steel	15	6"	03-0723-15	03-0724-15	03-0725-15	03-0726-15		
Titanium	15	6"	03-0723-15	03-0724-15			03-0727-15	03-0728-15
Steel	18	7"	03-0723-18	03-0724-18	03-0725-18	03-0726-18		
Titanium	18	7"	03-0723-18	03-0724-18			03-0727-15	03-0728-18
Steel	21	8 1/4"			03-0725-21	03-0726-21		
Titanium	21	8 1/4"	03-0723-21	03-0724-21			03-0727-21	03-0728-21
Steel	23	9"			03-0725-23	03-0726-23		

Titanium

General Instruments

Bulldog Hemostatic Forceps
Bulldog Hämostatische Forceps

Bulldog Forceps hémostatique
Bulldog hemostático Forceps



Dieffenbach
04-0730-03
3.5cm/1½"
04-0730-05
5cm/2"



Dieffenbach
04-0731-03
3.5cm/1½"
04-0731-05
5cm/2"



Dieffenbach
04-0733-06
6cm/2½"



Dieffenbach
04-0734-06
6cm/2½"



Johns-Hopkins

Straight
gerade
droit
recto

- 04-0732-01 38mm/1½"
- 04-0732-02 51mm/2"
- 04-0732-03 57mm/2¼"
- 04-0732-04 63mm/2½"
- 04-0732-05 70mm/2¾"
- 04-0732-06 75mm/3"
- 04-0732-07 90mm/3½"

Curved
Gebogene
courbé
Curvo

- 04-0735-01 38mm/1½"
- 04-0735-02 51mm/2"
- 04-0735-03 57mm/2¼"
- 04-0735-04 63mm/2½"
- 04-0735-05 70mm/2¾"
- 04-0735-06 75mm/3"
- 04-0735-07 90mm/3½"



Carrel
04-0737-10
10cm/4"

04-0736-10
24.5 cm 9 3/4"

Haemorrhoidal Clamps
Hämorrhoiden Clamps
Pincès hémorroïdaires
Abrazaderas hemorroidales

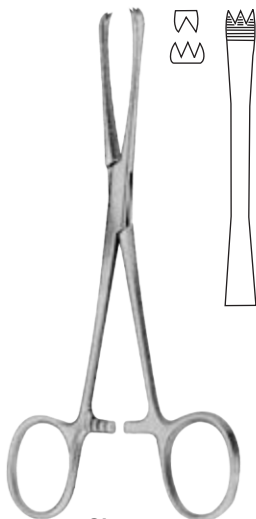

Chaput
04-0738-13
13cm/5"

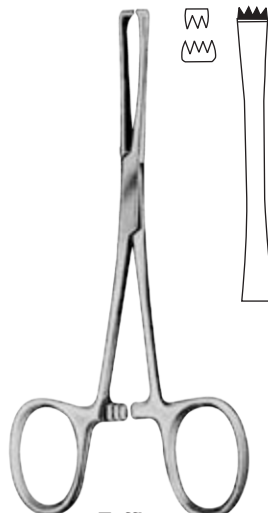

Tuffier
04-0739-13
13cm/5"



Pratt
04-0740-15
15cm/6"

General Instruments

Hemostatic Forceps
Arterienklemmen

pincas h emostatiques
pinzas hemost aticas



04

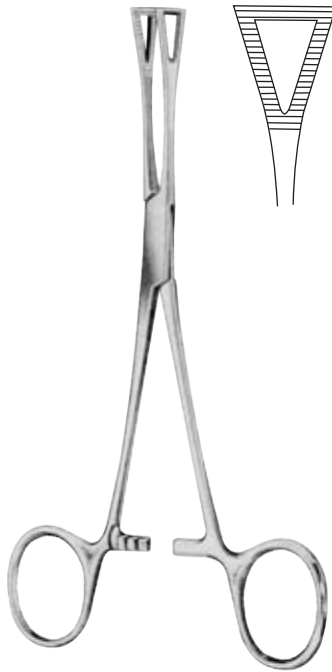

Pennington
04-0741-15 15 cm/6"
04-0741-20 20cm/8"



04-0742-00
12.5 cm/5"

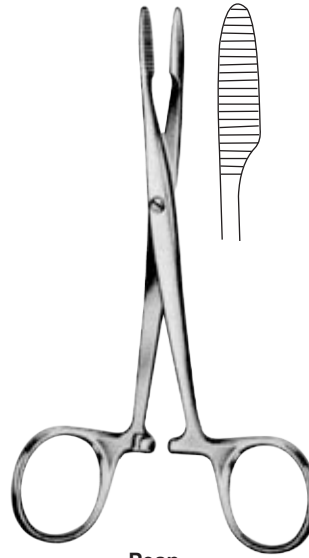

Pean
04-0743-00
16.5cm/6 3/4"

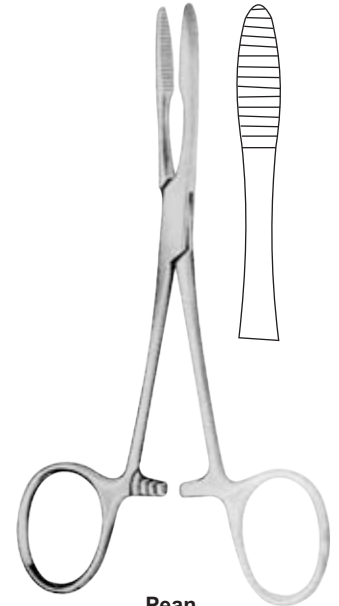

Pean
04-0744-14 14cm/5 1/2"
04-0745-16 16cm/6 1/2"

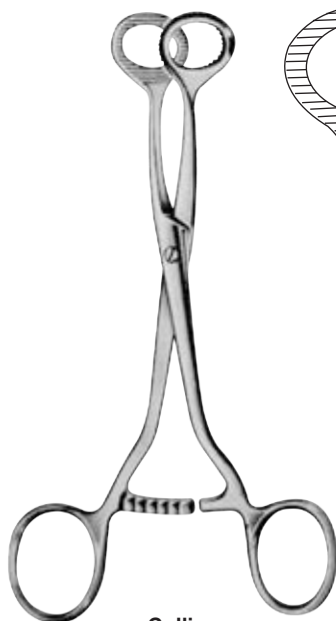

Collin
04-0746-15
15,5 cm/6"

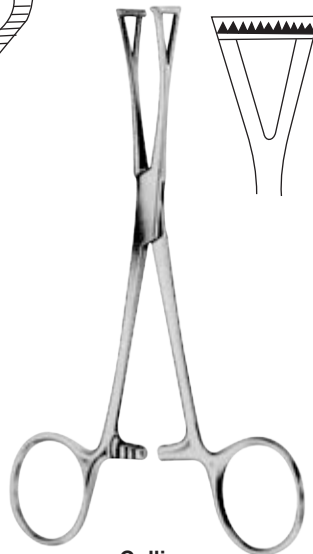

Collin
04-0747-14
14 cm/5 1/2"



Collin
04-0748-16
16,5 cm/6 1/2"

General Instruments

Hemostatic Forceps
Arterienklemmen

pinces hémostatiques
pinzas hemostáticas



Micro-Mosquito
10 cm/4"
12.5 cm/5 "



04-0749-10
04-0749-12



04-0751-10
04-0751-12



04-0750-10
04-0750-12



04-0752-10
04-0752-12

Very fine
sehr feine
très bien
Muy bien



Jacobson-Halstead
12.5 cm/5"



04-0753-13



04-0754-13



Hartmann
10 cm/4"



04-0755-10



04-0757-10



04-0756-10



04-0758-10



Halstead-Mosquito
12.5 cm/5"
14 cm/5 1/2"



04-0759-12
04-0759-14



04-0761-12
04-0761-14



04-0760-12
04-0760-14



04-0762-12
04-0762-14

General Instruments

Hemostatic Forceps
Arterienklemmen

pincas hémostatiques
pinzas hemostáticas



04



Halstead-Mosquito

18 cm/7"
21 cm/8 1/4"



04-0763-18
04-0763-21

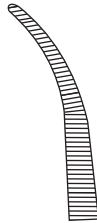

04-0765-18
04-0765-21



04-0764-18
04-0764-21



04-0766-18
04-0766-21

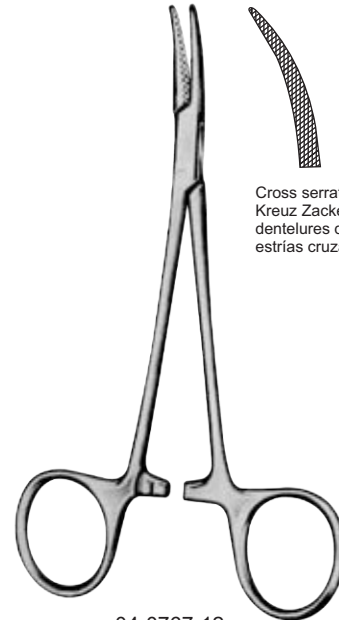

Cross serrations
Kreuz Zacken
dentelures de la Croix-
estrias cruzadas

04-0767-12
12 cm /4 3/4"



Kally
14 cm/5 1/2"
Kally-Rankin
16 cm/6 1/4"



04-0768-14



14 cm/5 1/2" 04-0769-14



04-0768-16



16 cm/6 1/4" 04-0769-16

General Instruments

Hemostatic Forceps
Arterienklemmen

pincès hémostatiques
pinzas hemostáticas



Crile
14 cm/5½"

Crile-Rankin
16 cm/6¼"



04-0770-14 14 cm/5½"



04-0772-14



04-0771-16 16 cm/6¼"



04-0773-16



Baby-Crile
14 cm/5½"



04-0774-14



04-0775-14



Crile
14 cm/5½"

Crile-Rankin
16 cm/6¼"



04-0776-14 14 cm/5½"

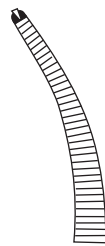

04-0777-14



04-0778-16 16 cm/6¼"

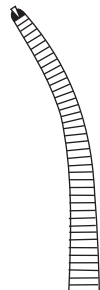

04-0779-16



Baby-Crile
14 cm/5½"



04-0780-14



04-0781-14

General Instruments

Hemostatic Forceps
Arterienklemmen

pinces hémostatiques
pinzas hemostáticas



04



Coller-Crile



04-0782-14 14 cm/5 1/2"



04-0784-16 16 cm/6 1/4"



Coller-Crile
04-0786-16
16 cm/6 1/4"

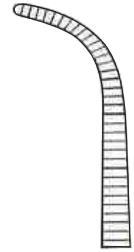

Leriche
15 cm/6"

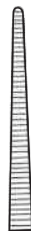

04-0787-15

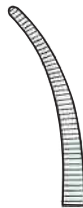

04-0788-15



04-0789-15



04-0790-15



Providence
14 cm/5 1/2"



04-0791-14



04-0792-14

General Instruments

Hemostatic Forceps
Arterienklemmen

pincès hémostatiques
pinzas hemostáticas

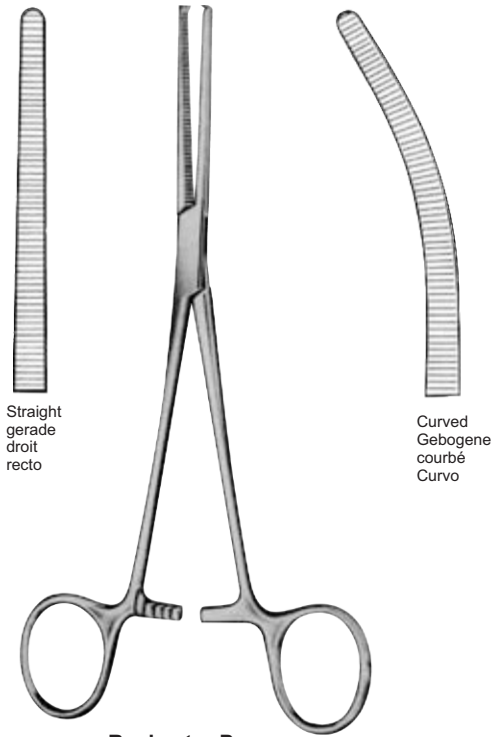

Straight
gerade
droit
recto

Curved
Gebogene
courbé
Curvo

Rochester-Pean

STR	WD	cm	in
04-0793-13	04-0794-13	13.0	5"
04-0793-14	04-0794-14	14.0	5 1/2"
04-0793-16	04-0794-16	16.0	6 1/4"
04-0793-18	04-0794-18	18.0	7"
04-0793-20	04-0794-20	20.0	8"
04-0793-22	04-0794-22	22.0	8 3/4"
04-0793-24	04-0794-24	24.0	9 1/2"
04-0793-26	04-0794-26	26.0	10 1/4"
04-0793-30	04-0794-30	30.0	12"

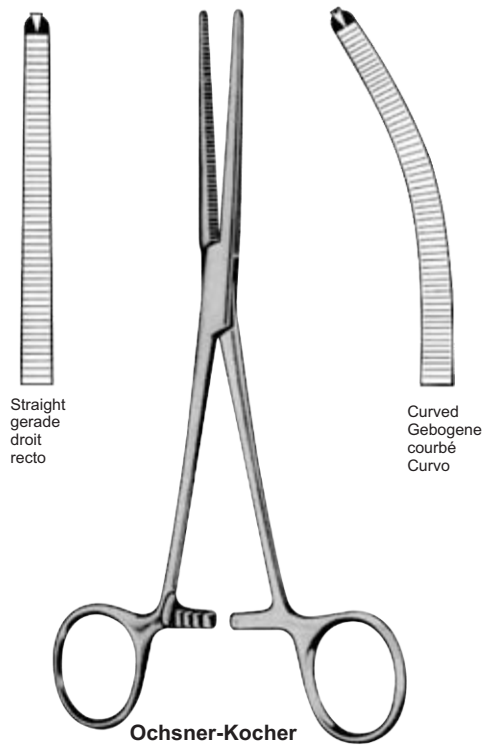

Straight
gerade
droit
recto

Curved
Gebogene
courbé
Curvo

Ochsner-Kocher

STR	WD
04-0795-13	04-0796-13
04-0795-14	04-0796-14
04-0795-16	04-0796-16
04-0795-18	04-0796-18
04-0795-20	04-0796-20
04-0795-22	04-0796-22
04-0795-24	04-0796-24
04-0795-26	04-0796-26
04-0795-30	04-0796-30

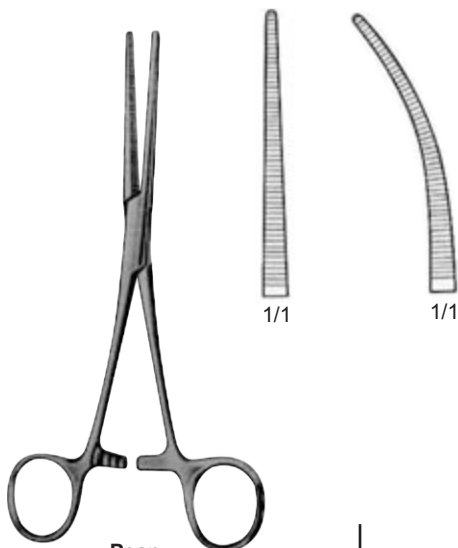

1/1

1/1

Fine
feine
fin
multa

Pean

		cm	in
04-0797-13	04-0798-13	13.0	5"
04-0797-14	04-0798-14	14.0	5 1/2"
04-0797-16	04-0798-16	16.0	6 1/4"

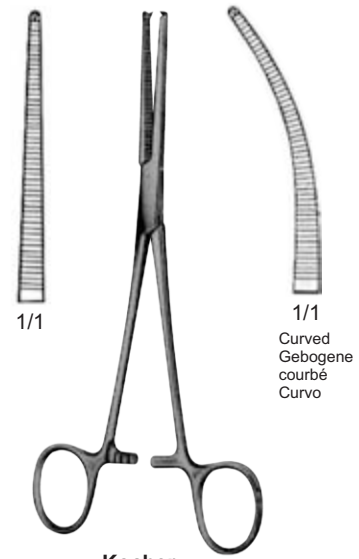

1/1

1/1
Curved
Gebogene
courbé
Curvo

Kocher

04-0799-13	04-0800-13
04-0799-14	04-0800-14
04-0799-16	04-0800-16

General Instruments

Hemostatic Forceps
Arterienklemmen

pincas h emostatiques
pinzas hemost aticas



04

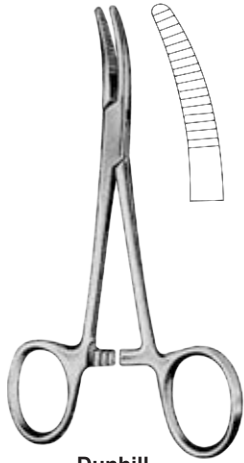

Dunhill
04-0801-13
13cm/5"

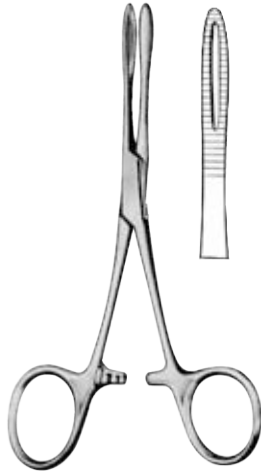

Kronlein
04-0802-13
13cm/5"

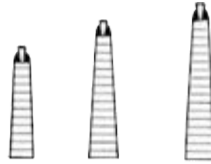
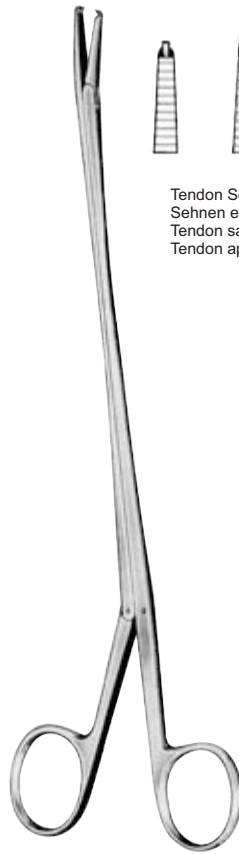

Tendon Seizing Forcep
Sehnen ergriff forcep
Tendon saisir pince
Tendon apoderarse f orceps

Brand
04-0803-15 15cm/6"
04-0803-19 19cm/7 1/2"
04-0803-24 24cm/9 1/2"

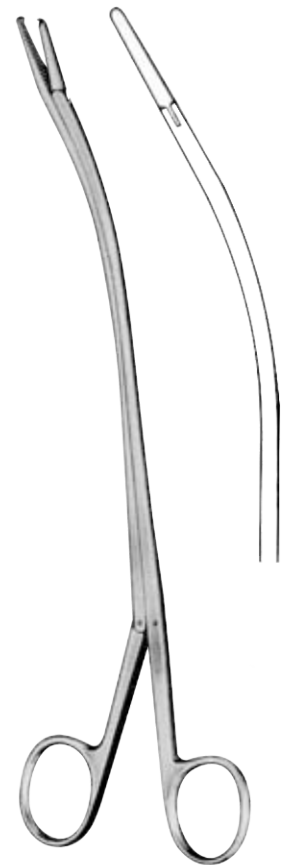

Brand
04-0804-15 15cm/6"
04-0804-19 19cm/7 1/2"
04-0804-24 24cm/9 "

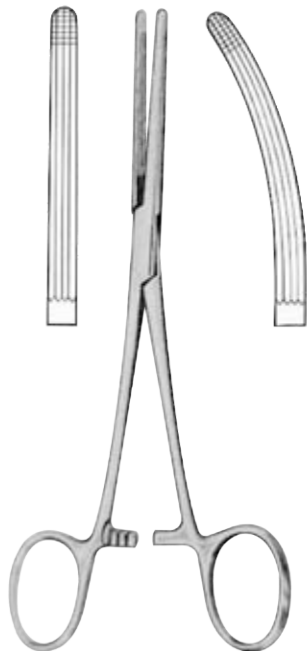

Rochester-Carmalt
04-0805-16
16cm/6 1/4"
20cm/8"

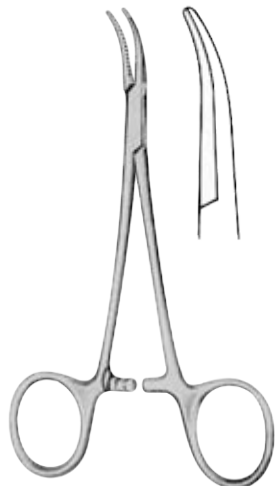

Mosquito-Dandy
04-0806-12
12cm/4 3/4"

Lateral Curved
Gekr ummte seitlichen
lat erale incurv ee
lateral curvo

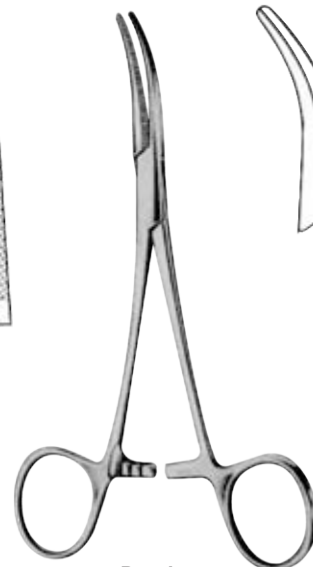

Dandy
14cm/5 1/2"



04-0807-14



04-0808-14

General Instruments

Hemostatic Dissecting and Ligature Forceps
 Hämostatische Dissecting und Ligaturklemmen

Dissection Pince hémostatique et ligatures
 La disección y pinzas hemostáticas ligaduras



Adson
 18.5cm/7¼"

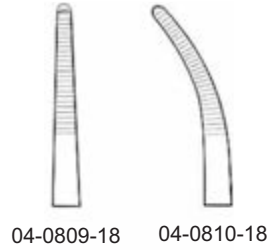

04-0809-18 04-0810-18

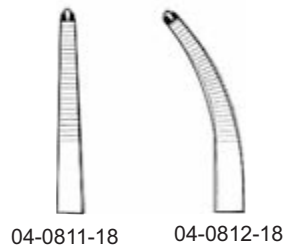

04-0811-18 04-0812-18

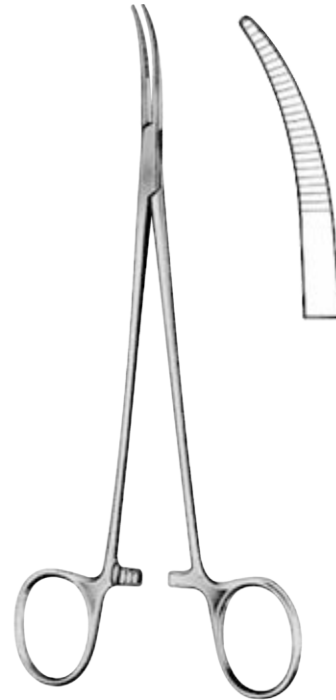

Nissen
 04-0813-18 18.5cm/7¼"
 04-0814-22 22.0cm/8¾"

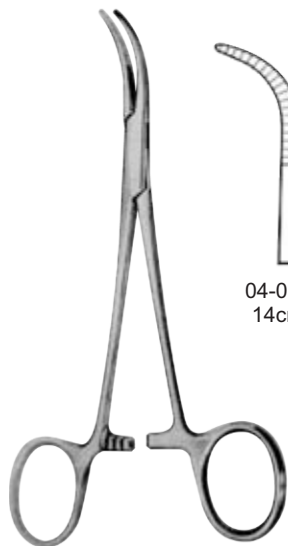

Baby-Adson



04-0815-14
 14cm/5½"

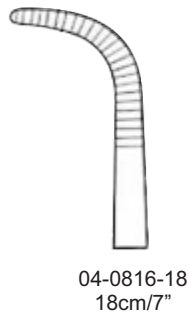

04-0816-18
 18cm/7"

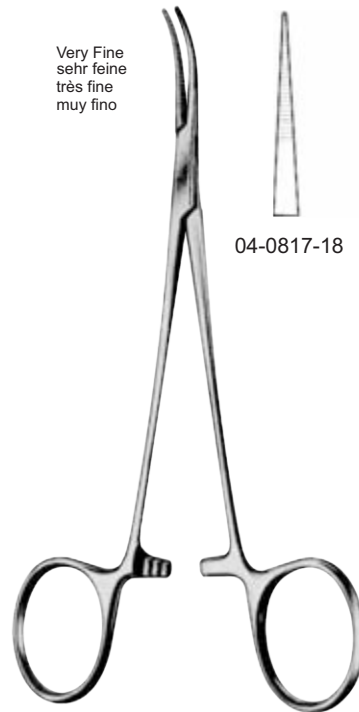

Jacobson-Adson
 18cm/7"

Very Fine
 sehr feine
 très fine
 muy fino

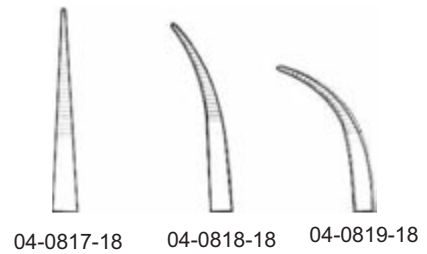

04-0817-18 04-0818-18 04-0819-18

General Instruments

Hemostatic Forceps
Arterienklemmen

pincas h emostatiques
pinzas hemost aticas



04



Lovelace
04-0820-15
15.5cm/6"



Dixon-Lovelace
04-0821-16
16cm/6¼"



Dixon-Lovelace
04-0822-16
16cm/6¼"



Bainbridge
15cm/6"
18cm/7"



04-0823-15
04-0823-18



04-0824-15
04-0824-18



Fuchsig
04-0825-19
19cm/7½"

General Instruments

Hemostatic Forceps
Arterienklemmen

pincas hémostatiques
pinzas hemostáticas



Schnidt
19cm/7½"



04-0826-19

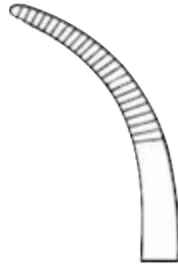

04-0827-19

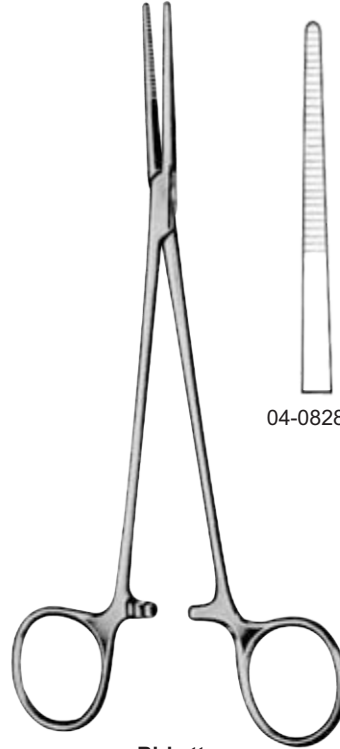

Birkett
19cm/7½"



04-0828-19



04-0829-19



Bengolea



20cm/8"	04-0830-20	04-0831-20	04-0832-20	04-0833-20
22cm/8¾"	04-0830-22	04-0831-22	04-0832-22	04-0833-22
24cm/9½"	04-0830-24	04-0831-24	04-0832-24	04-0833-24
26cm/10¼"	04-0830-26	04-0831-26	04-0832-26	04-0833-26

General Instruments

Hemostatic Forceps
Arterienklemmen

pinces hémostatiques
pinzas hemostáticas

04



Bridge
27cm/10½"

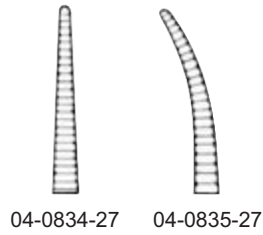

Roberts
22cm/8¾"

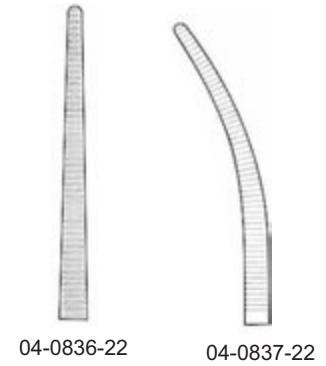

Kelly

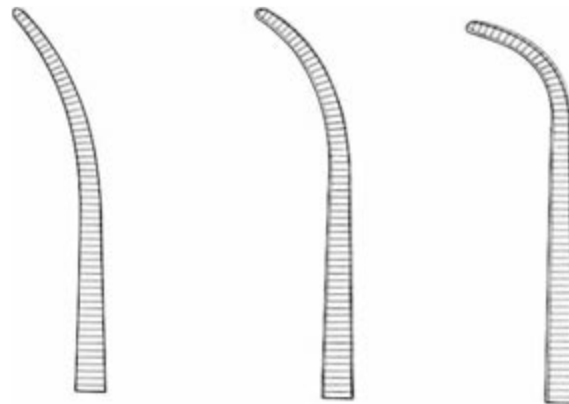

19cm/7½"	04-0838-19	04-0839-19	04-0840-19
22cm/8¾"	04-0838-22	04-0839-22	04-0840-22
24cm/9½"	04-0838-24	04-0839-24	04-0840-24

General Instruments

Bronchus and Hemostatic Forceps
Bronchien und Arterienklemmen

Pince hémostatique des bronches et
Pinzas de bronquios y hemostático



04-0841-24



04-0842-24

Sarot
24cm/9½"



04-0843-22
22cm/8¾"



04-0844-23
23cm/9"



04-0845-24
24cm/9½"

Crafoord-Sellors

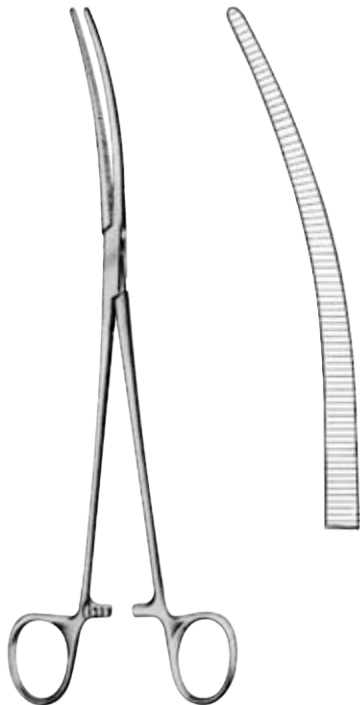

Crafoord

04-0846-18 18cm/7"
04-0846-24 24cm/9½"

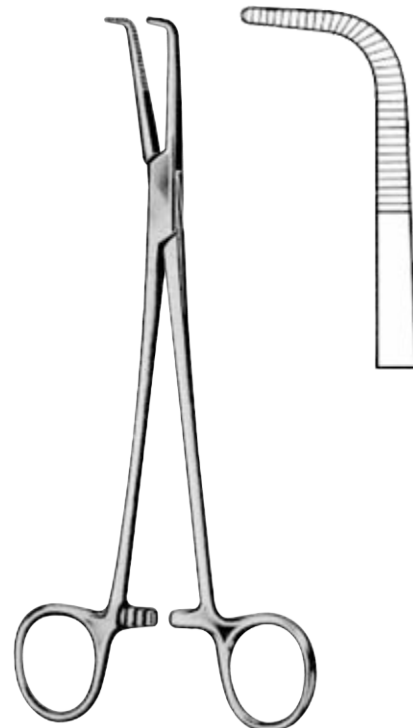

Kantrowtiz

04-0847-19 19cm/7½"
04-0847-24 24cm/9½"
04-0847-26 26.5cm/10½"

General Instruments

Dissecting and Ligature Forceps
Anatomische und Ligaturklemmen

Dissection et Pince Ligatures
Pinzas de disección y ligadura

04



Johns Hopkins
04-0848-20
20cm/8"

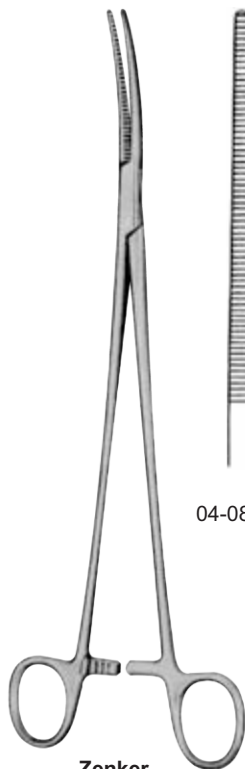

Zenker
29.5cm/11½"

04-0849-29



04-0850-29

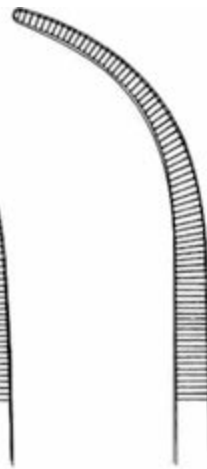

04-0851-29

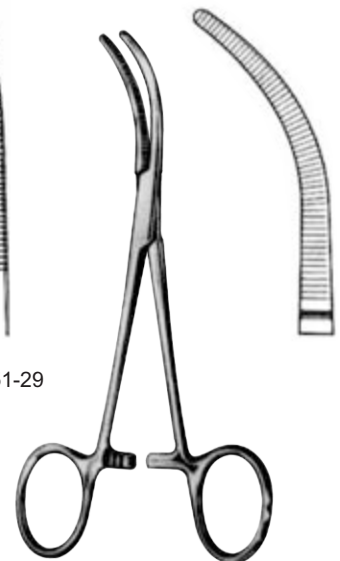

Baby-Overholt
04-0852-13
13.5cm/5¼"



Rumel
23cm/9"



04-0853-23



04-0854-23



04-0855-23



04-0856-23

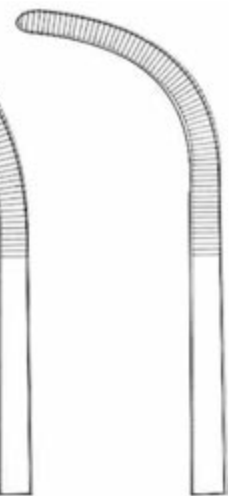

04-0857-23

General Instruments

Dissecting and Ligature Forceps
Anatomische und Ligaturklemmen

Dissection et Pince Ligatures
Pinzas de disección y ligadura



Overholt-Slim



04-0858-18
18.5cm/7 1/4"

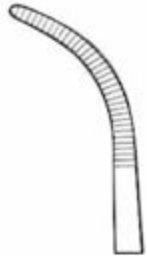

04-0859-20
20.5cm/8"

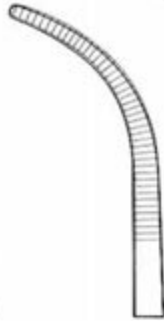

04-0860-21
21cm/8 1/4"

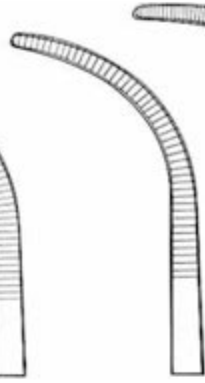

04-0861-21
21.5cm/8 1/2"

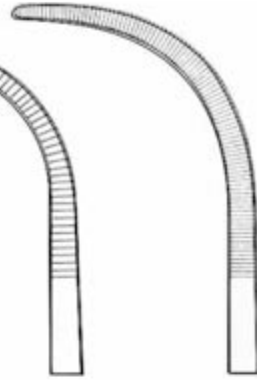

04-0862-24
24cm/9 1/2"



Overholt-Slim



04-0863-18
18.5cm/7 1/4"



04-0864-20
20.5cm/8"

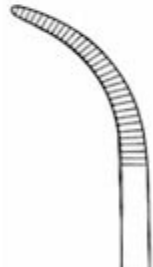

04-0865-21
21cm/8 1/4"

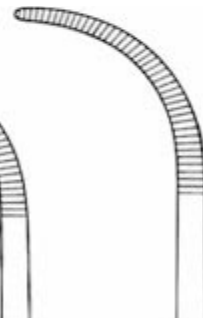

04-0866-21
21.5cm/8 1/4"



General Instruments

Dissecting and Ligature Forceps
Anatomische und Ligaturklemmen

Dissection et Pince Ligatures
Pinzas de disección y ligadura



04



Overholt-Geissendorfer
21cm/8¼"
27cm/10½"

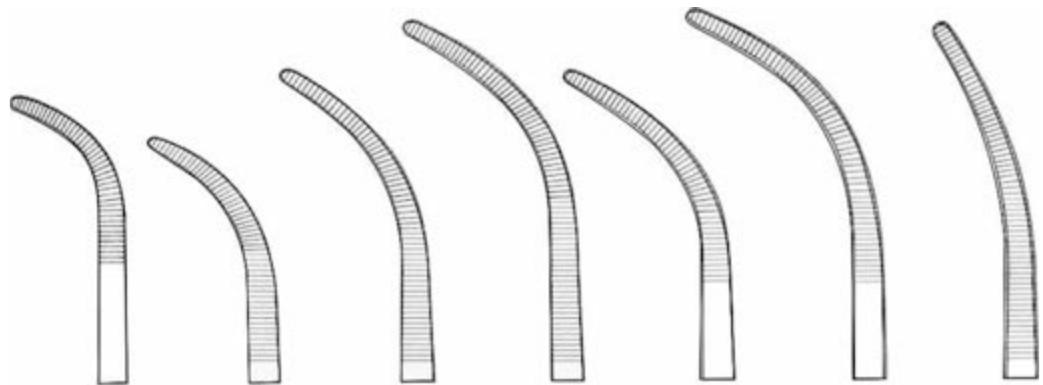

04-0867-21
04-0867-27

04-0868-21
04-0868-27

04-0869-21
04-0869-27

04-0870-21
04-0870-27

04-0871-21
04-0871-27

04-0872-21
04-0872-27

04-0873-21
04-0873-27

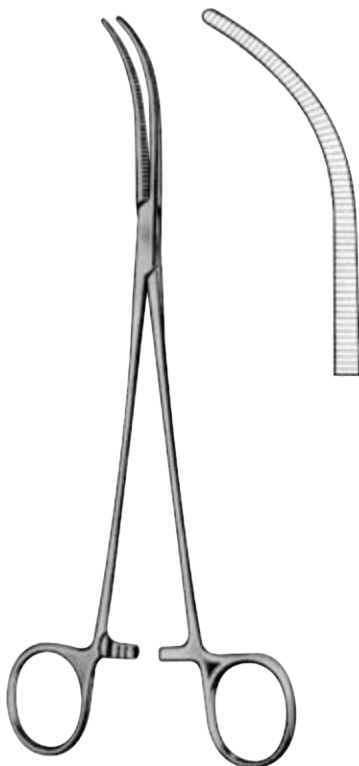

Overholt-Mixter
04-0874-21
21cm/8¼"

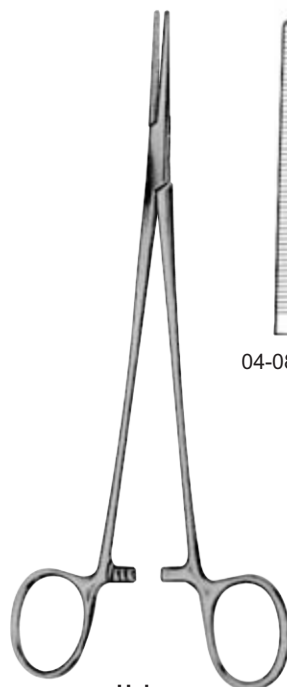

Heiss
20cm/8"

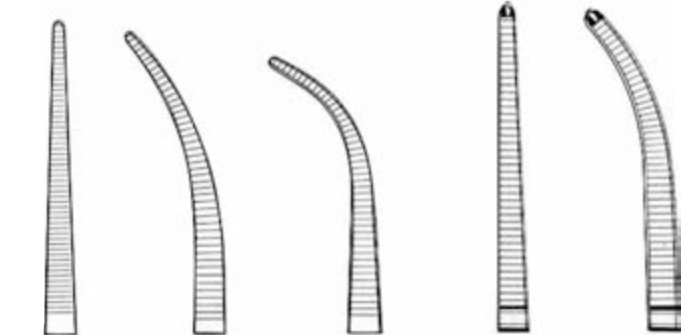

04-0875-20

04-0876-20

04-0877-20

04-0878-20

04-0879-20

General Instruments

Dissecting and Ligature Forceps
Anatomische und Ligaturklemmen

Dissection et Pince Ligatures
Pinzas de disección y ligadura



Meeker
04-0880-27
27 cm/10"



Toennis
21 cm/8¼"
26 cm/10¼"

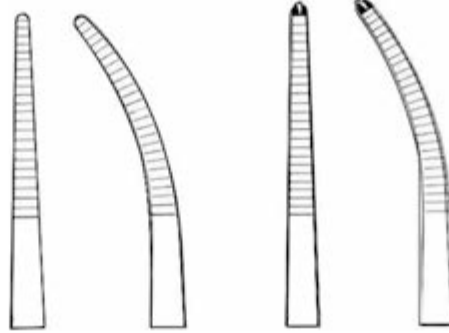

04-0881-21 04-0882-21 04-0883-21 04-0884-21
04-0881-26 04-0882-26 04-0883-26 04-0884-26



Lower
04-0885-18
18 cm/7"



Gemini

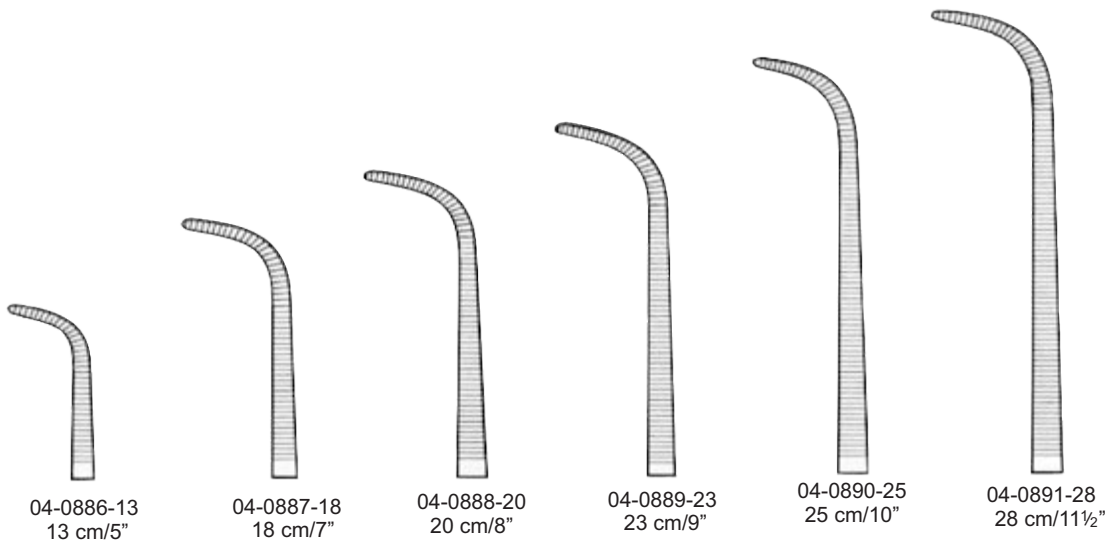

04-0886-13
13 cm/5"

04-0887-18
18 cm/7"

04-0888-20
20 cm/8"

04-0889-23
23 cm/9"

04-0890-25
25 cm/10"

04-0891-28
28 cm/11½"

General Instruments

Dissecting and Ligature Forceps
Anatomische und Ligaturklemmen

Dissection et Pince Ligatures
Pinzas de disección y ligadura



04

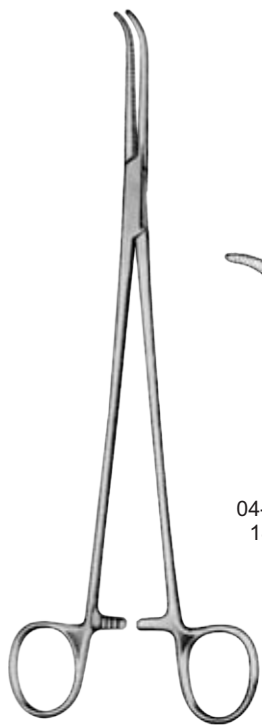

Mini-Gemini

04-0892-18
18 cm/7"

04-0893-22
22 cm/8¾"

04-0894-25
25 cm/10"

04-0895-28
28 cm/11"

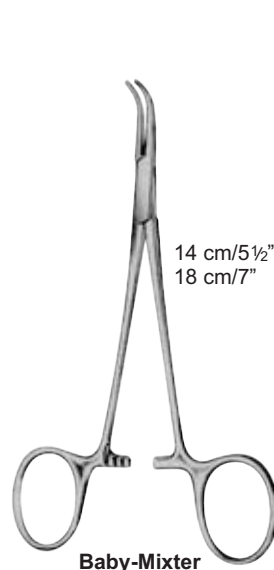

Baby-Mixer

14 cm/5½"
18 cm/7"

04-0896-14
04-0896-18

04-0897-14
04-0897-18



Mixer
04-0898-15 15 cm/6"
04-0898-19 19 cm/7½"

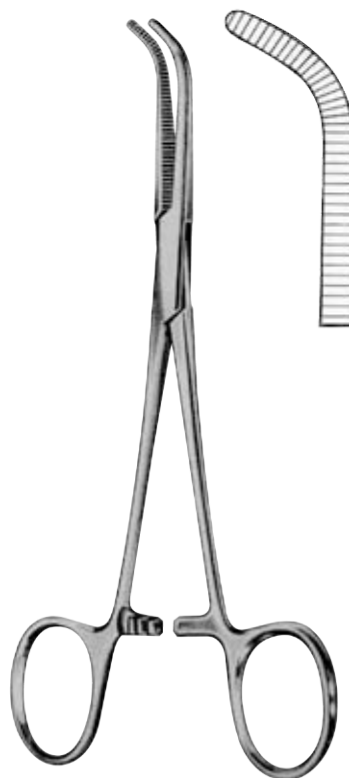

Mixer-O'Shaugnessy
04-0899-15 15.5 cm/6"
04-0899-19 19.0 cm/7½"

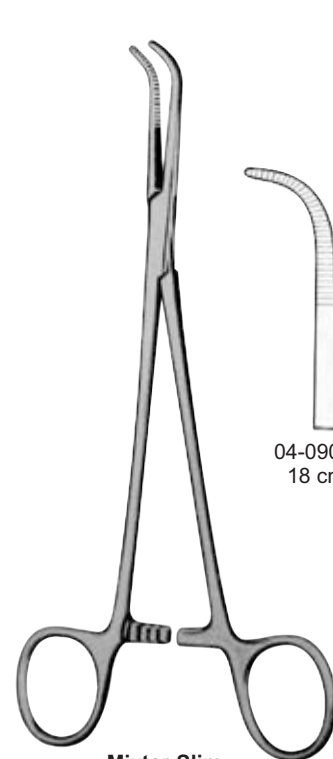

Mixer-Slim

04-0900-18
18 cm/7"

04-0901-23
23 cm/9"

General Instruments

Dissecting, Ligature Forceps and Gall Stone Clamps
 Anatomische, Faden-Pinzetten und Klemmen Gallenstein

Pinces à disséquer ligature et colliers en pierre Gall
 Pinzas de disección, ligadura y abrazaderas de cálculos biliares

04



04-0902-22
22 cm/8¾"

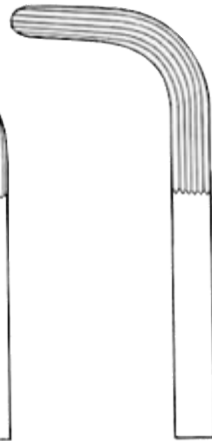
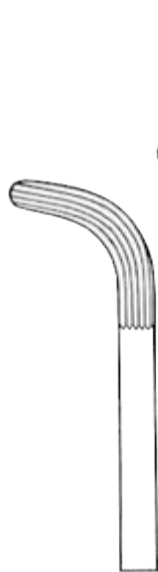

04-0903-25
25 cm/10"

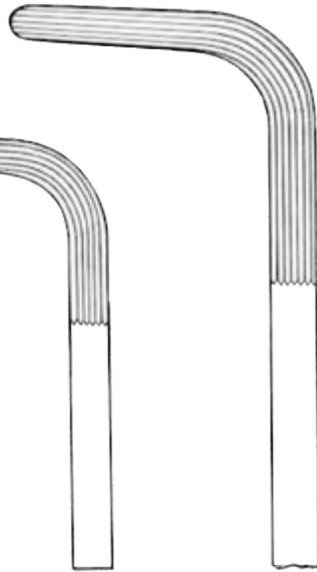

04-0904-28
28 cm/11"



04-0905-22
22 cm/8¾"



04-0906-20
20 cm/8"

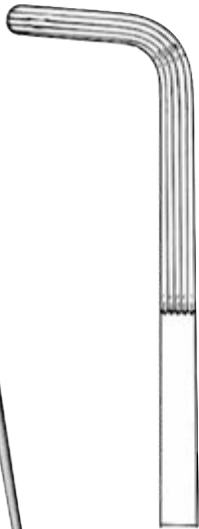

04-0907-24
24 cm/9½"

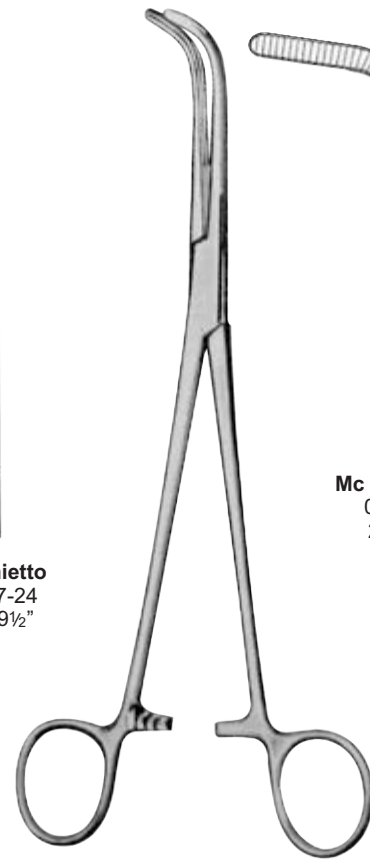

04-0908-22
22 cm/8¾"

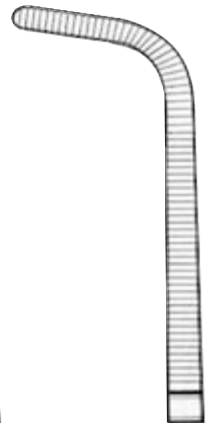

General Instruments

Dissecting, Gall Duct Clamps and Hemostatic Forceps
 Zergliedern, Gallenwegefunktionsstörungen Klemmen und
 Arterienklemmen

Pinces à dissection Gall, de conduits et des pinces hémostatiques
 Disección, Gall conducto abrazaderas y pinzas hemostáticas



04

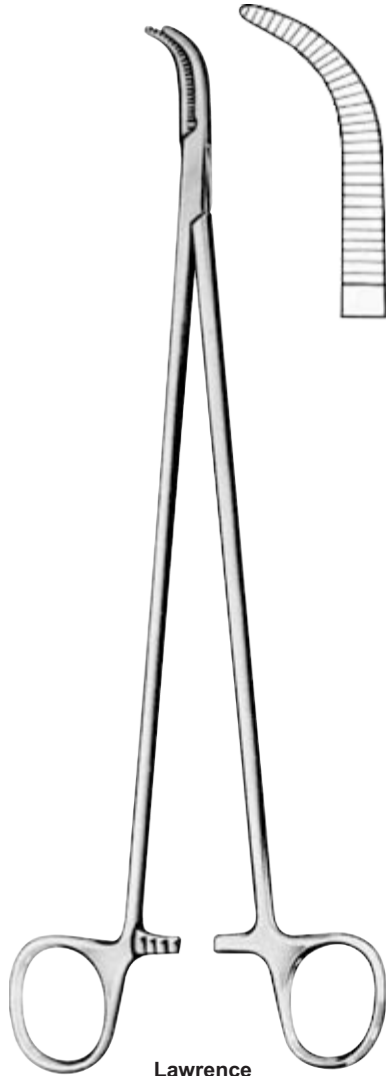

Lawrence
 04-0909-27
 27.5 cm/10¾"

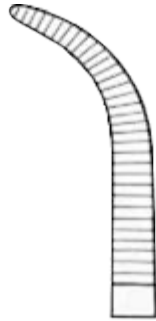

Lahey (Sweet)

04-0910-19
 19 cm/7½"



04-0911-23
 23 cm/9"



Spencer-Wells

- 04-0912-13 13 cm/5"
- 04-0912-14 14 cm/5 ½"
- 04-0912-15 15 cm/6"
- 04-0912-18 18 cm/7"
- 04-0912-20 20 cm/8"
- 04-0912-23 23 cm/9"

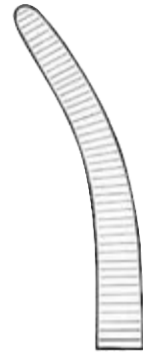

- 04-0913-13
- 04-0913-14
- 04-0913-15
- 04-0913-18
- 04-0913-20
- 04-0913-23

General Instruments

Parametrium and Hysterectomy Forceps
Parametrium und Hysterektomie Zange

Pince paramètre et hystérectomie
Parametrio y Histerectomía Pinzas

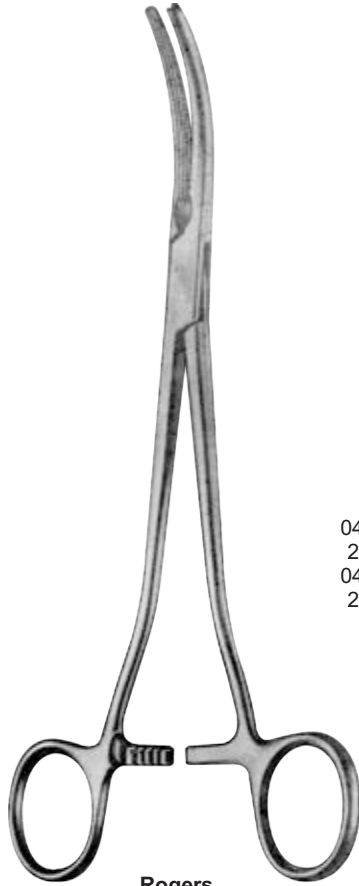

Rogers

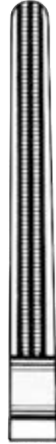

04-0914-22
22.5 cm/9"
04-0914-25
25.0 cm/10"



04-0915-22
22.0 cm/8³/₄"
04-0915-24
24.5 cm/9³/₄"

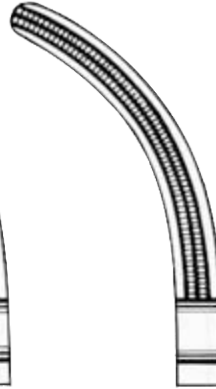

04-0916-21
21.5 cm/8¹/₂"
04-0916-24
24.0 cm/9¹/₂"

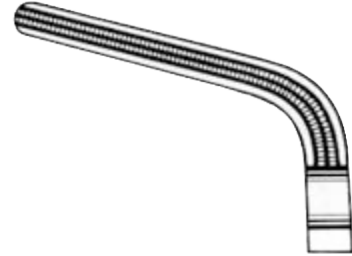

04-0917-20
20.5 cm/8"
04-0917-23
23.5 cm/9"

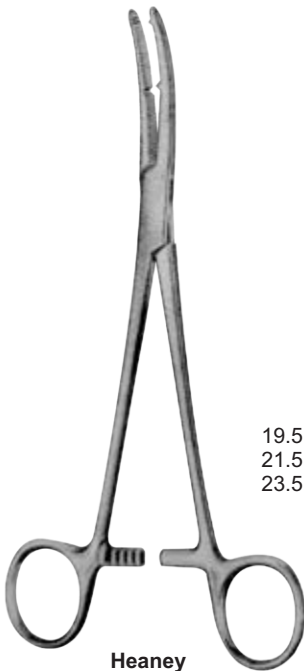

Heaney



19.5 cm/7¹/₂" 04-0918-19
21.5 cm/8¹/₄" 04-0918-21
23.5 cm/9" 04-0918-23



04-0919-19
04-0919-21
04-0919-23

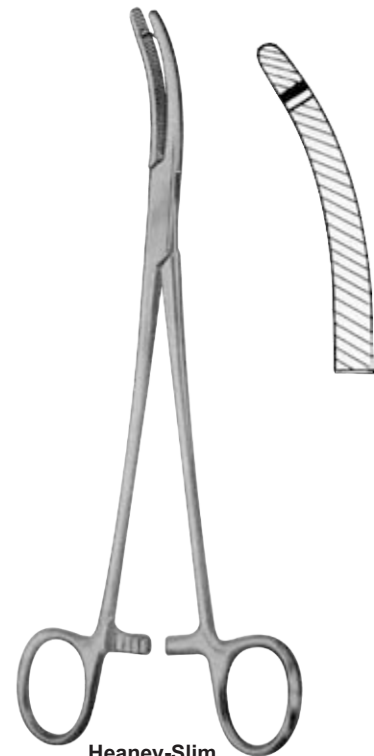

Heaney-Slim
04-0920-21
21 cm/8¹/₄"

General Instruments

Hysterectomy Forceps
Hysterectomy Zange

Zange Hysterectomy
Hysterectomy Zange



04



Ballentine
04-0921-21
21cm/8¼"



Heaney-Ballentine
04-0922-21
21cm/8¼"



Tonsil Forceps
Pince amygdales
Pinzas de amígdalas

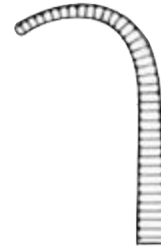

Fig. 1

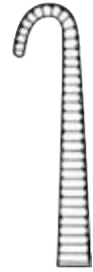
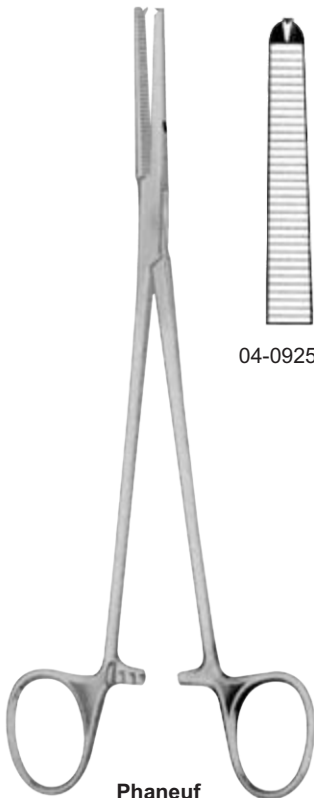

Fig. 2

Negus
04-0923-19 19cm/7½" 04-0924-19



Phaneuf
21.5cm/8½"



04-0925-21

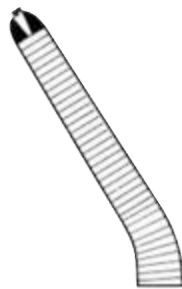

04-0926-21

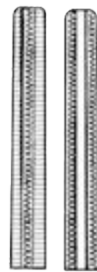

Haemorrhoidal Clamps
Hämorrhoiden Clamps
Pincés hémorroidaires
Abrazaderas hemorroidales

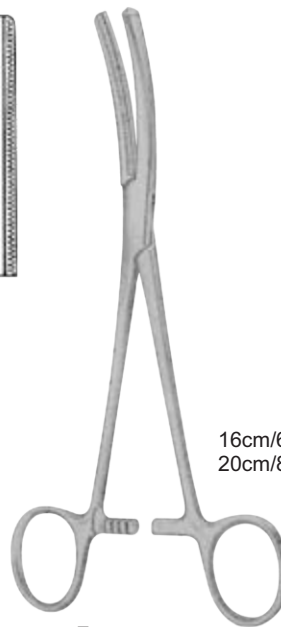

Fergusson

	Straight gerade droit recto	Curved Gebogene courbé Curvo
16cm/6 ¼"	04-0927-16	04-0928-16
20cm/8"	04-0927-20	04-0928-20

General Instruments

Clamp and Artery Forceps
Clamp und Arterienklemmen

Pince de serrage et de l'artère
Abrazadera y de la arteria Pinzas

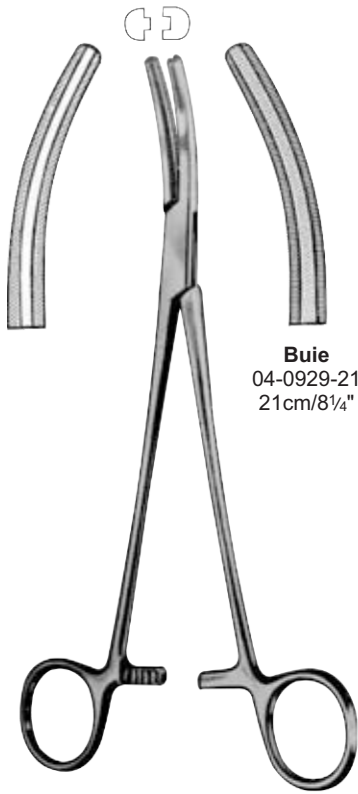

Buie
04-0929-21
21cm/8¼"

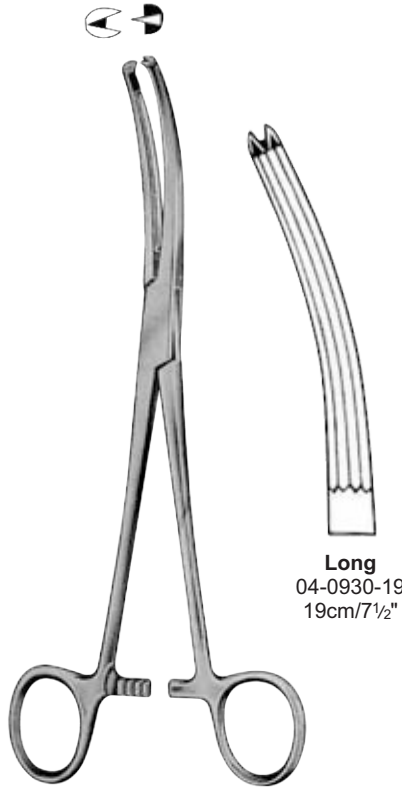

Long
04-0930-19
19cm/7½"

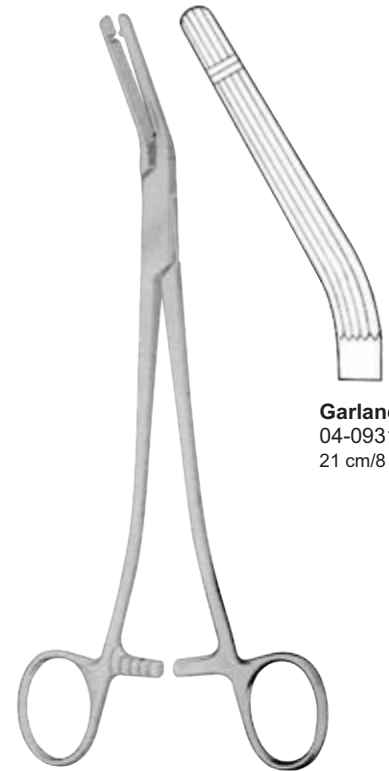

Garland
04-0931-21
21 cm/8 ¼"

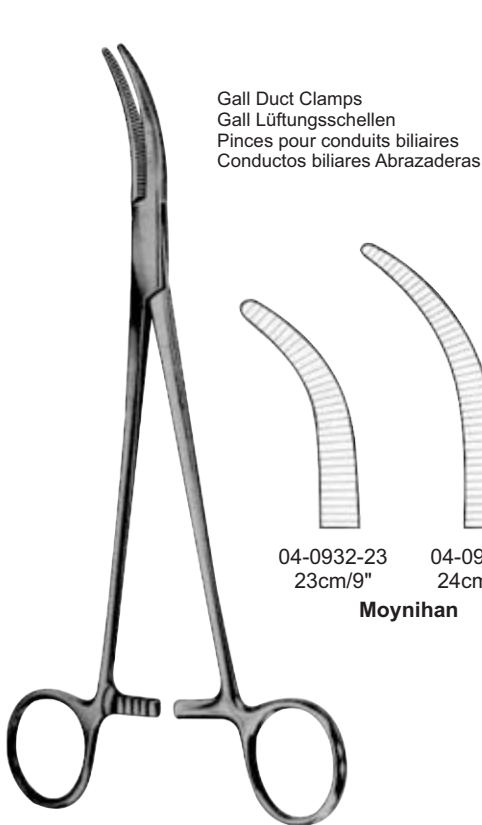

Gall Duct Clamps
Gall Lüftungsschellen
Pincés pour conduits biliaires
Conduitos biliares Abrazaderas

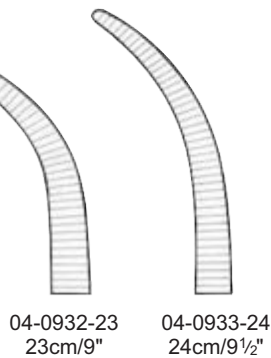

04-0932-23 23cm/9"
04-0933-24 24cm/9½"

Moynihan

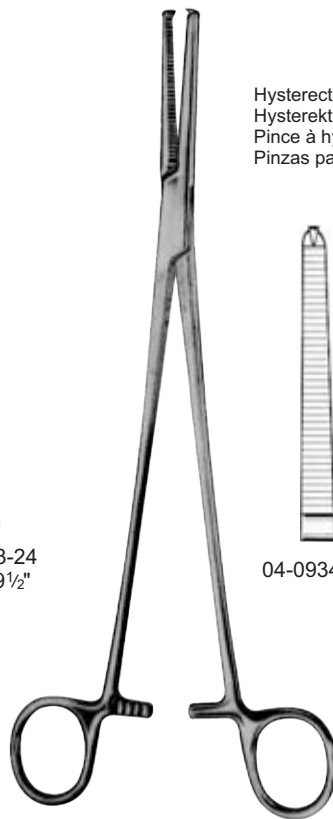

Hysterectomy Forceps
Hysterektomie Zange
Pince à hystérectomie
Pinzas para histerectomía

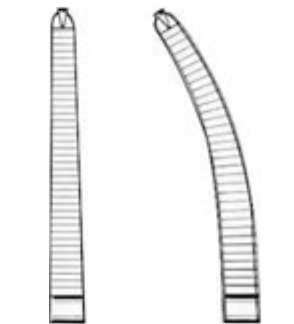

04-0934-23 04-0935-23

Hozlbach
23.5cm/9¼"



Pressure Clamps
Druckklemmen
Pincés de pression
Mordazas

Zweifel
04-0936-17
17.5cm/7"

General Instruments

Hysterectomy Clamp and Vaginal Forceps
Hysterektomie Clamp und Vaginal Forceps

Clamp hystérectomie et Vaginal Forceps
La histerectomía y la abrazadera Vaginal Forceps



04

Scalp Flap Forceps
Pinces à rabat cuir chevelu
Pinzas del cuero cabelludo Flap

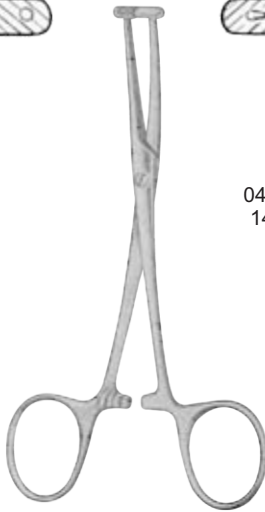

Martel
04-0938-14
14cm/5½"

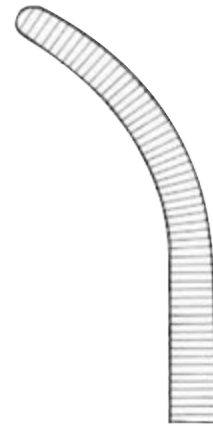

Wertheim
04-0939-25
25cm/10"

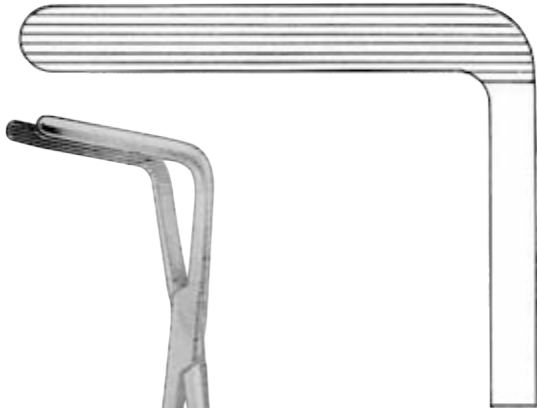

Werheim-Cullen
04-0940-21
21.5cm/8½"



Extra Strong
extra Strong
extra Fuerte

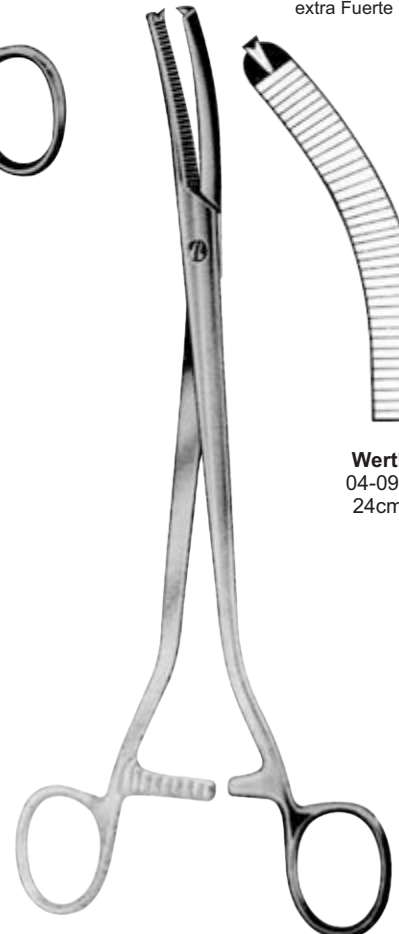
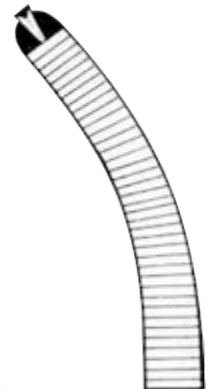

Werheim
04-0941-24
24cm/9½"

General Instruments

Hysterectomy Clamp and Vaginal Forceps
 Hysterektomie Clamp und Vaginal Forceps

Clamp hystérectomie et Vaginal Forceps
 La histerectomía y la abrazadera Vaginal Forceps

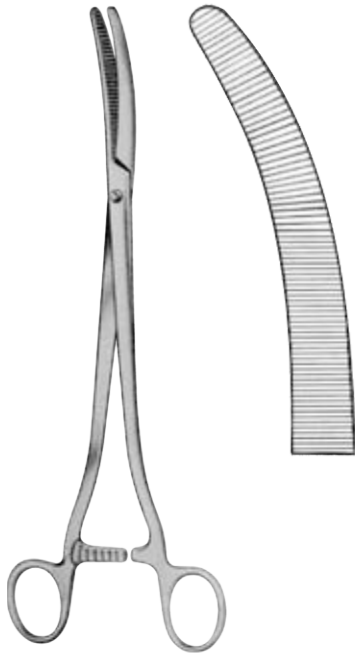

Faure
 04-0942-25
 25cm/10"



23cm/9"

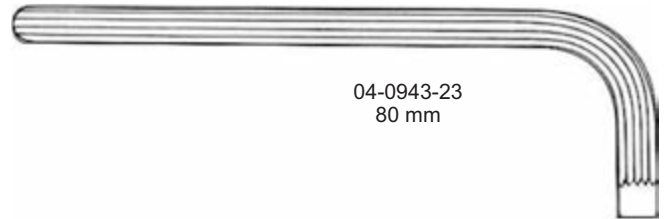

04-0943-23
 80 mm

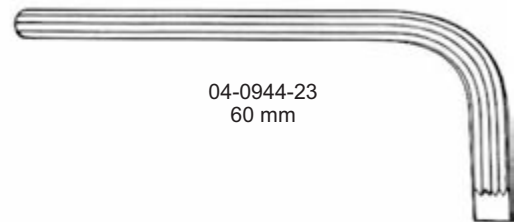

04-0944-23
 60 mm



Wertheim
 22cm/8¾"



04-0945-22
 Slightly Curved
 leicht gebogen
 légèrement incurvé
 Ligeramente curvada



04-0946-22
 More Curved
 mehr Curved
 plus courbé
 más curvo

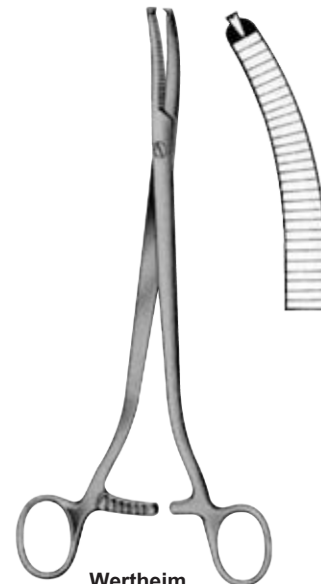

Wertheim
 04-0947-22
 22cm/8¾"

General Instruments

Peritoneal Clamp and Hysterectomy Forceps
Peritoneal Clamp und Hysterektomie Zange

Pince Forceps péritonéale et hystérectomie
Abrazadera peritoneal y pinzas hysterectomía



04

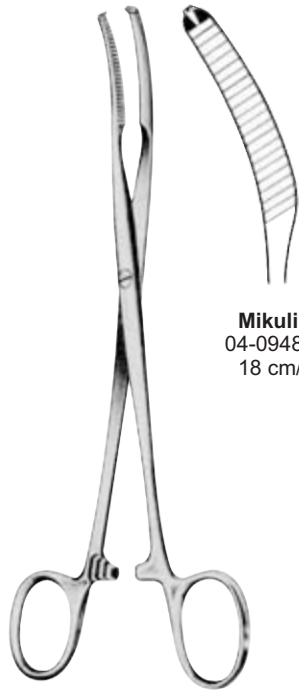

Mikulicz
04-0948-18
18 cm/7"

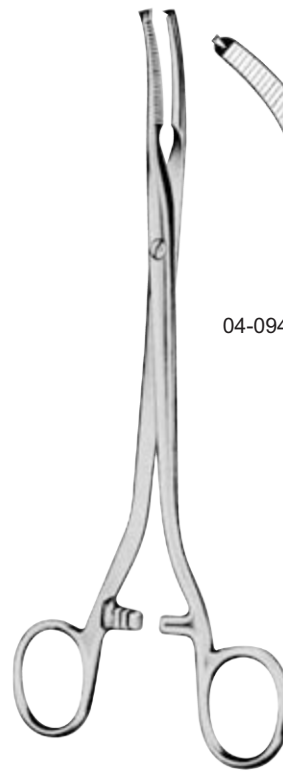

Mikulicz
04-0949-20 20 cm/8" 04-0950-20

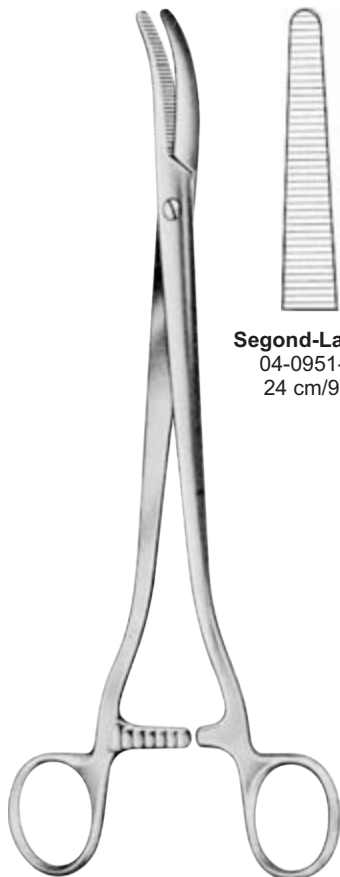
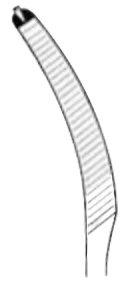

Segond-Landau
04-0951-24
24 cm/9½"



Segond
04-0952-24
24 cm/9½"

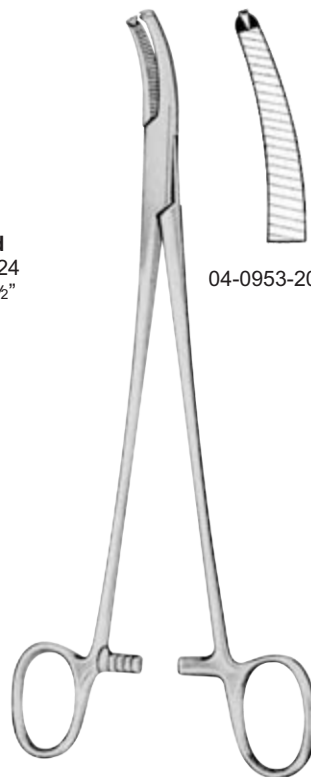

Faure
04-0953-20 20 cm/8" 04-0954-20

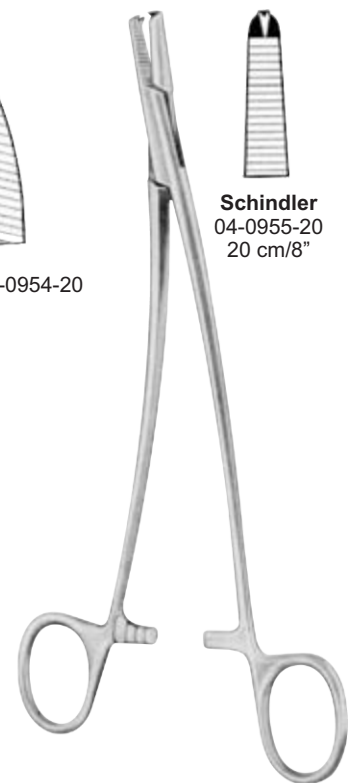

Schindler
04-0955-20
20 cm/8"



General Instruments

Peritoneal Clamp Forceps
Peritoneal Klammerzange

Pince de serrage péritonéale
Pinzas peritoneal Clamp

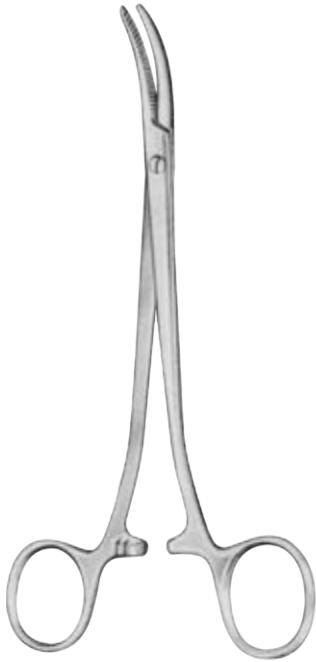

Wertheim
04-0956-18
18 cm/7"

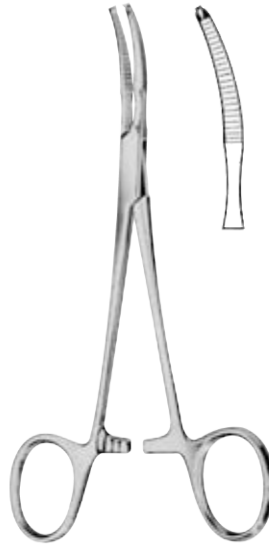

Baby-Mikulicz
04-0957-14
14 cm/5½"

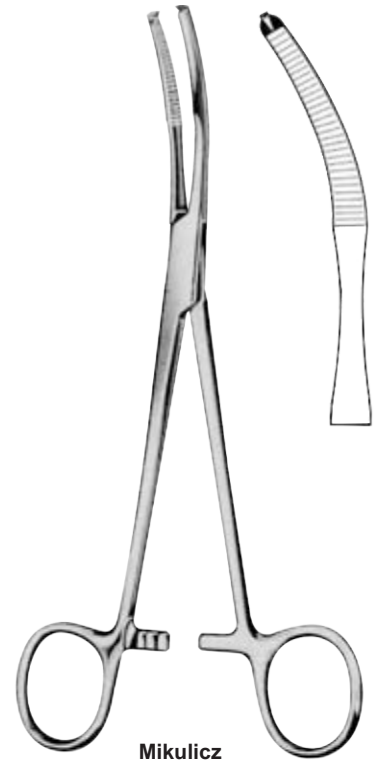

Mikulicz
04-0958-18 18cm/7"
04-0958-20 20cm/8"

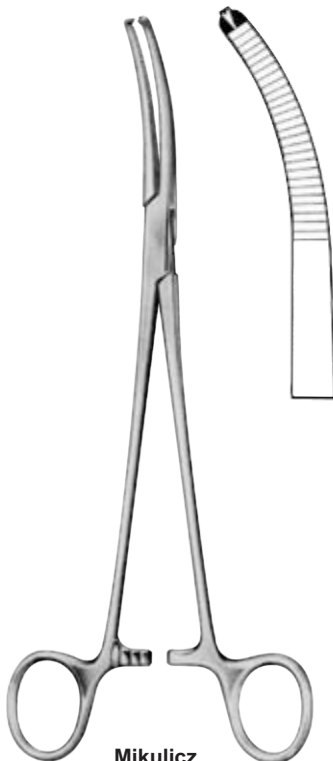

Mikulicz
04-0959-20
20 cm/8"

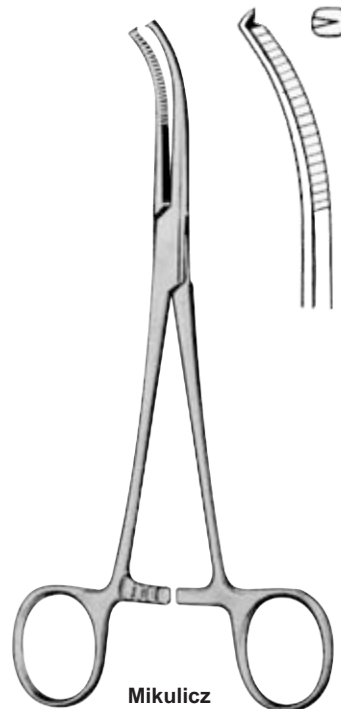

Mikulicz
04-0960-18
18.5 cm/7¼"

General Instruments

Towel Forceps
Tuchklemmen

Pince porte-serviettes
Pinzas de toallas

04



Schadel
04-0961-09
9 cm/3½"



Jones
04-0962-05 5 cm/2"
04-0962-09 9 cm/3½"



Engl-Modell
04-0963-09
9 cm/3½"



Backhaus
04-0964-09 9 cm/3½"
04-0964-11 11 cm/4½"
04-0964-13 13 cm/5"
04-0964-15 15 cm/6"

With clip for Tubing or Cable
Mit Clip für Schläuche oder Kabel
Avec clip pour tube ou câble
Con clip para tubos o cables



04-0965-11 11 cm/4½"
04-0965-13 13 cm/5"



Peers-Bertram
04-0966-14
14 cm/5½"

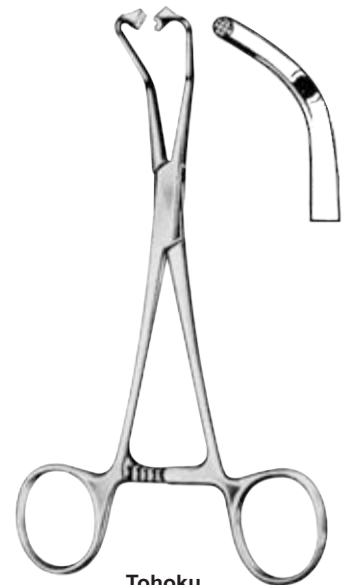

Tohoku
04-0967-10 10 cm/4"
04-0968-13 13 cm/5"

General Instruments

Towel Forceps
Tuchklemmen

Pince porte-serviettes
Pinzas de toallas



Ball and socket
04-0969-10 10 cm/4"
04-0969-13 13 cm/5¼"



Roeder
04-0970-13 13 cm/5"
04-0970-15 15 cm/6"



Lorna
04-0971-10 10 cm/4"
04-0971-13 13 cm/5"

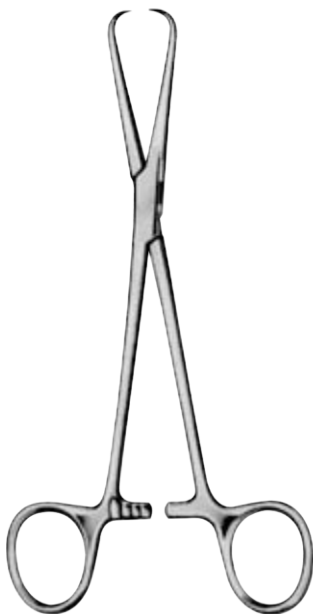

Bernhard
04-0972-16 16.5 cm/6½"



Lane
04-0973-13 13cm/5"
04-0973-15 15cm/6"
04-0973-18 18cm/7"
04-0973-20 20cm/8"
20 cm/8"



Doyen
04-0974-18
18 cm/7"

General Instruments

Tubing Forceps
Schläuche Pinzetten

Pince tubes
Pinzas de tubo



04

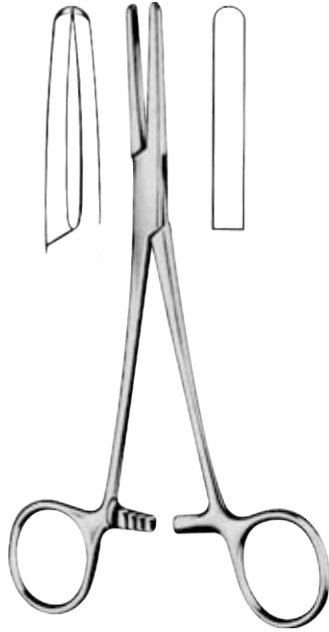

04-0975-14 14 cm/5 1/2"
04-0975-15 15 cm/6"
04-0975-18 18 cm/7"
04-0975-20 20 cm/8"

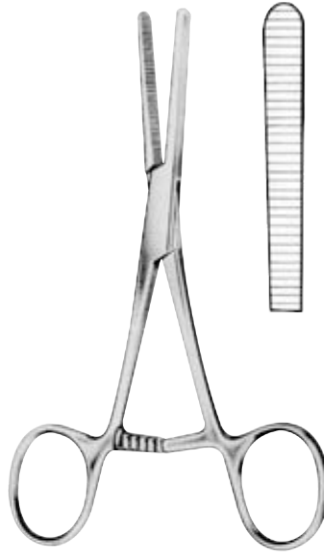

04-0976-14
14 cm/5 1/2"



04-0977-16 16.5 cm/6 1/2"
04-0977-18 18.0 cm/7"

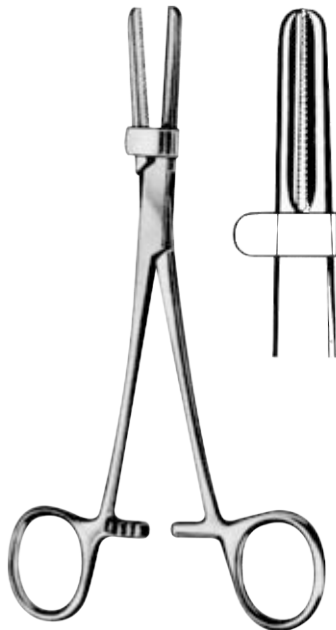

04-0978-15 15 cm/6"
04-0978-18 18 cm/7"
04-0978-20 20 cm/8"

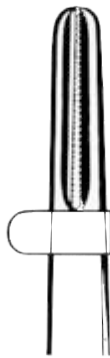

Mohr
04-0979-50 50 mm
04-0979-60 60 mm
04-0979-70 70 mm
04-0979-80 80 mm

Sizes
mm
13
17
20
25
30

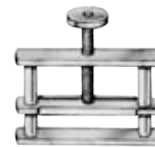

Hoffmann
04-0980-13
04-0980-17
04-0980-20
04-0980-25
04-0980-30



Hoffmann
04-0981-13
04-0981-17
04-0981-20
04-0981-25
04-0981-30

General Instruments

Cotton Swab Polypus and Dressing Forceps
Wattestabchen und Tupfer-Kornzange

Coton-tige Polypus et pinces a pansement
Esponja de algodon Polipos y pinzas Dressing

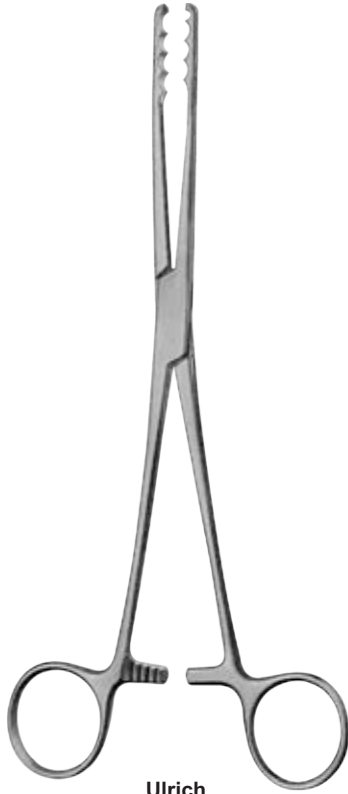

Ulrich

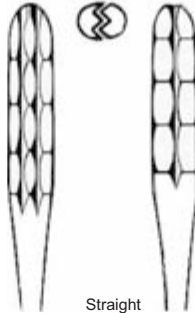

Straight
gerade
droit
recto

05-0982-22
05-0982-25
05-0982-27

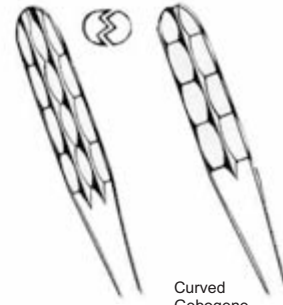

Curved
Gebogene
courbe
Curvo

22 cm/8³/₄"
25 cm/10"
27 cm/10¹/₂"

05-0983-22
05-0983-25
05-0983-27



05-0984-13
05-0984-15
05-0984-18

Lister

13 cm/5"
15 cm/6"
18 cm/7"

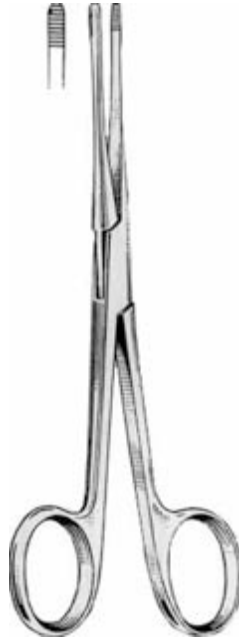

05-0985-13
05-0985-15
05-0985-18

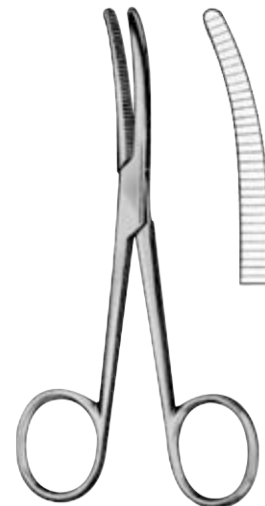

Bryant
05-0986-13
13 cm/5"

General Instruments

Polypus and Dressing Forceps
Tupfer und Pinzette

Polypus et pinces à pansement
Pólipos y pinzas de Vestir



05



Gross-Maier

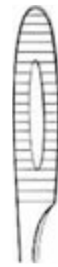

Straight
gerade
droit
recto



Curved
Gebogene
courbé
Curvo

With Ratchet
mit Ratchet
avec Ratchet
Con Ratchet

05-0987-20
05-0987-25

20 cm/8"
25 cm/10"

05-0988-20
05-0988-25

Without Ratchet
ohne Ratchet
sans cliquet
Sin Ratchet

05-0989-20
05-0989-25

20 cm/8"
25 cm/10"

05-0990-20
05-0990-25



Pelkmann
25 cm/10"

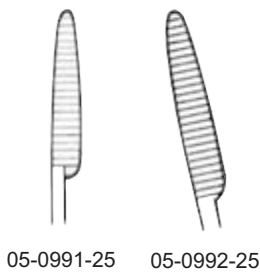

Sims-Maier
28 cm/11"

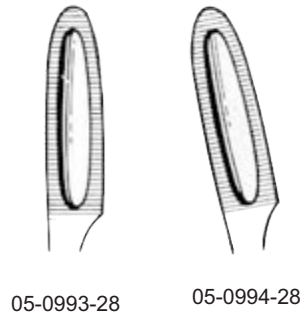

Duplay
20 cm/8"

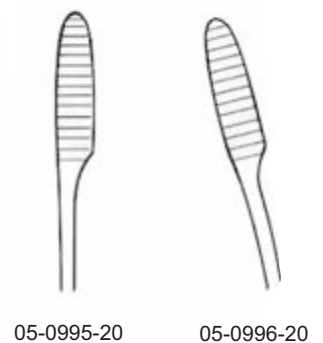

General Instruments

Tunneling Forceps
Tunneling Zange

Pince de tunneling
Pinzas de túnel

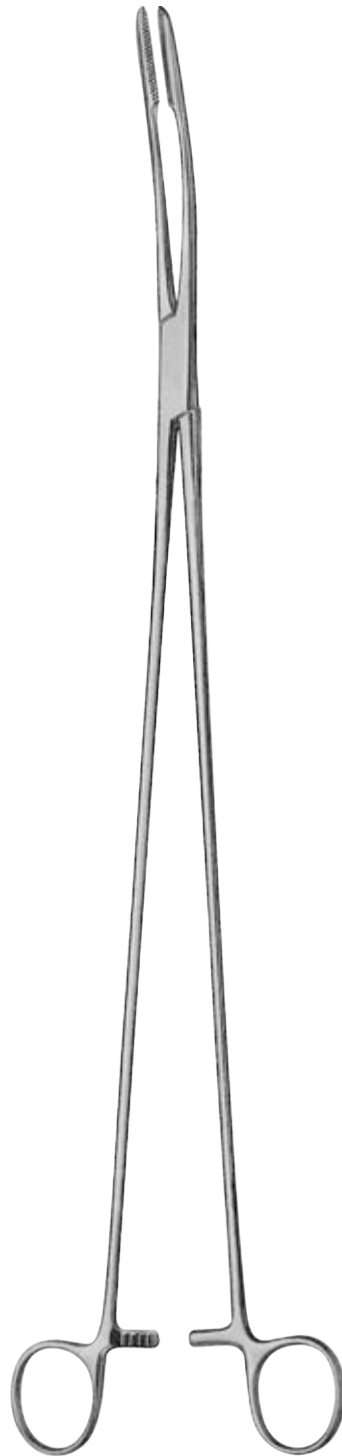

05-0997-40
39.5 cm 15 1/2"

General Instruments

Cotton Swab Forceps
Tupferzangen

Cotton-tige Forceps
Esponja de algodón Pinzas

05

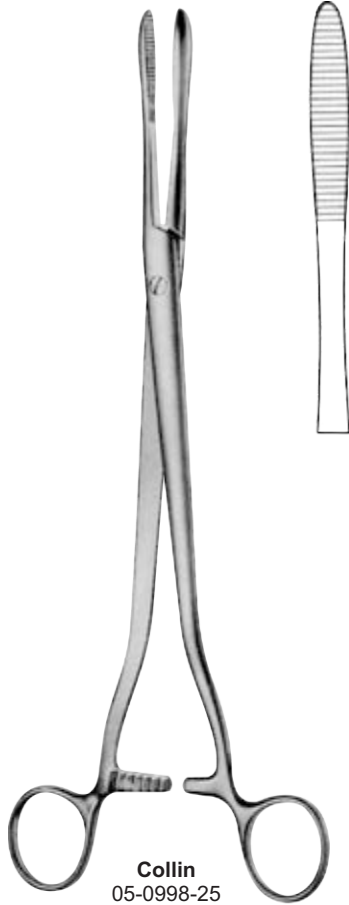

Collin
05-0998-25
25cm/10"
05-0999-25 B/J
25cm/10"

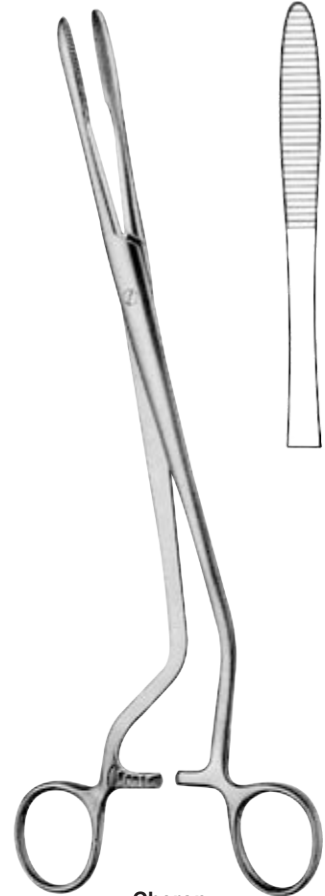

Cheron
05-1000-25
25cm/10"
05-1001-25 B/J
25cm/10"

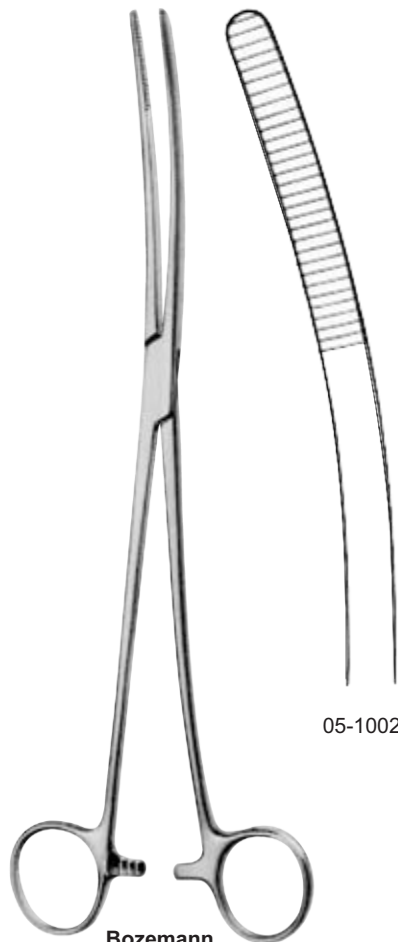

Bozemann
26cm/10 1/4 "

05-1002-26

General Instruments

Cotton Swab and Sponge Holding Forceps
Wattestäbchen und Sponge Haltezange

Coton-tige, éponge Davier
Hisopo de algodón y esponja Pinzas

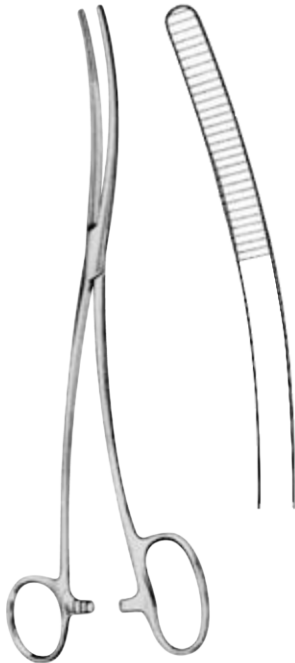

Bozemann-Douglas
05-1003-26
26cm/10¼"



Foerster

05-1004-25
25 cm/9¾"



05-1005-25
24.5 cm/9¾"

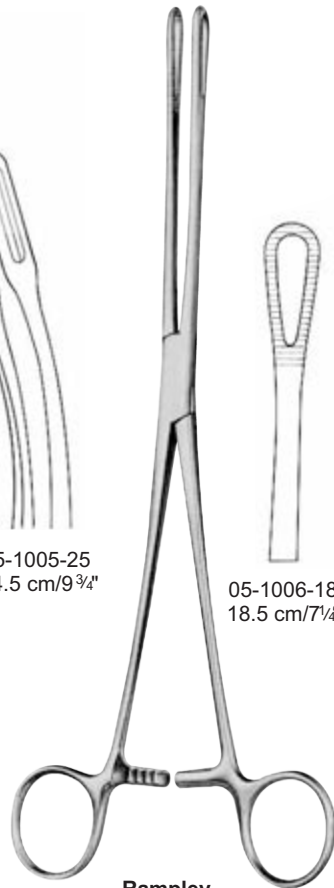

Rampley

05-1006-18 05-1007-24
18.5 cm/7¼" 24.5 cm/9¾"



Foerster

18 cm/7"
20 cm/8"
24 cm/9½"
25 cm/10"



05-1008-18
05-1008-20
05-1008-24
05-1008-25



05-1009-18
05-1009-20
05-1009-24
05-1009-25



05-1010-18
05-1010-20
05-1010-24
05-1010-25

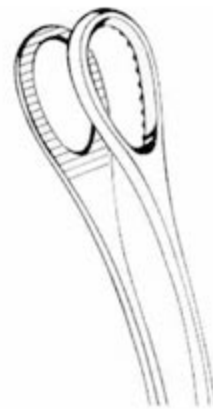

05-1011-18
05-1011-20
05-1011-24
05-1011-25

General Instruments

Bulldog Forceps
Bulldog Zange

Bulldog Pincers
Pinzas Bulldog



05



Schwartz
05-1012-19
19cm/7½"



05-1013-01



05-1014-02



05-1015-03

Applying Forceps
Anlegezangen
L'application de forceps
La aplicación de fórceps



05-1016-23
23cm/7"

Atrauma



Diethrich

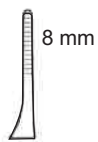

05-1017-08

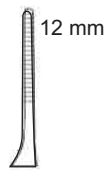

05-1017-12

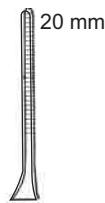

05-1017-20



05-1018-08



05-1018-12



05-1018-20

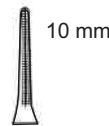

05-1019-10



05-1019-14



05-1019-20



05-1020-10

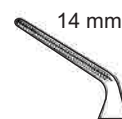

05-1020-14



05-1020-20

General Instruments

Wound and Nerve Hooks
Wund-und Nerven-Hooks

Crochets des plaies et du nerf
De la herida y los nervios Ganchos



Sharp
scharf
net
agudo
06-1025-01

blunt
stumpf
émousser
embotar
06-1025-02

Miller
13.5cm/5¼"



Crile
06-1026-20
20cm/8"



Cushing



Fig. 1

19cm/7 ½"
28cm/11"

06-1027-19
06-1027-28



Fig. 2

06-1028-19
06-1028-28



Kilner
06-1029-15
15cm/6"



Fig.1

Gillies
06-103018
18cm/7"



Fig.2

Gillies
06-1031-18
18cm/7"



Sharp
scharf
net
agudo

blunt
stumpf
émousser
embotar

Frazier
06-1032-13 13cm/5" 06-1033-13
06-1032-18 18cm/7" 06-1033-18

General Instruments

Wound and Nerve Hooks
Wund-und Nerven-Hooks

Crochets des plaies et du nerf
De la herida y los nervios Ganchos



06

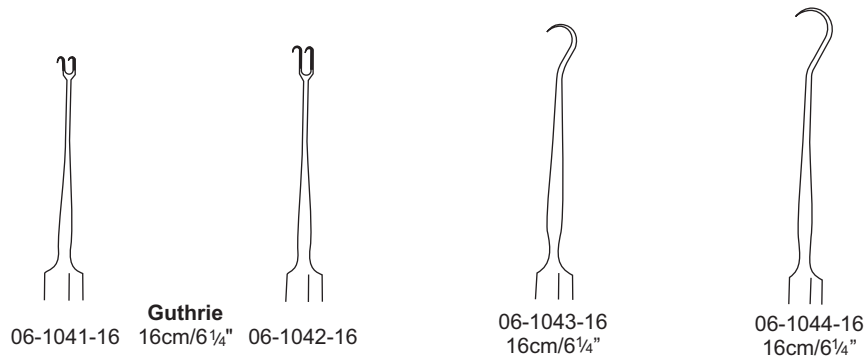
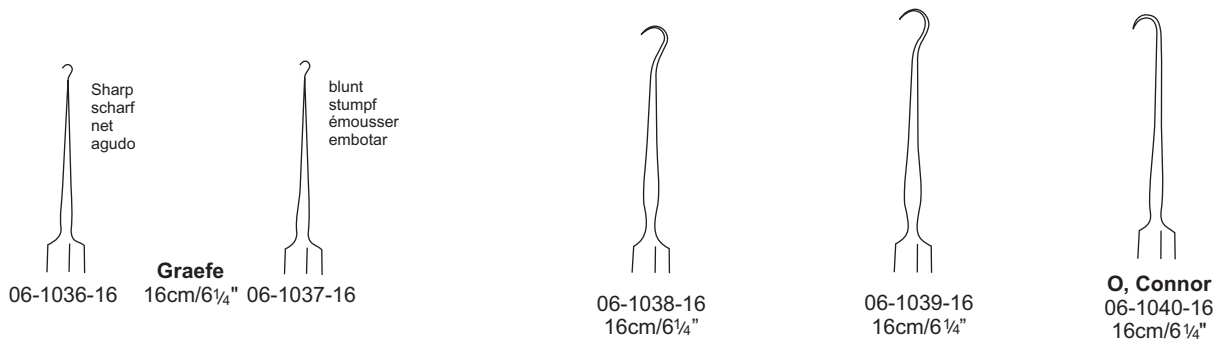
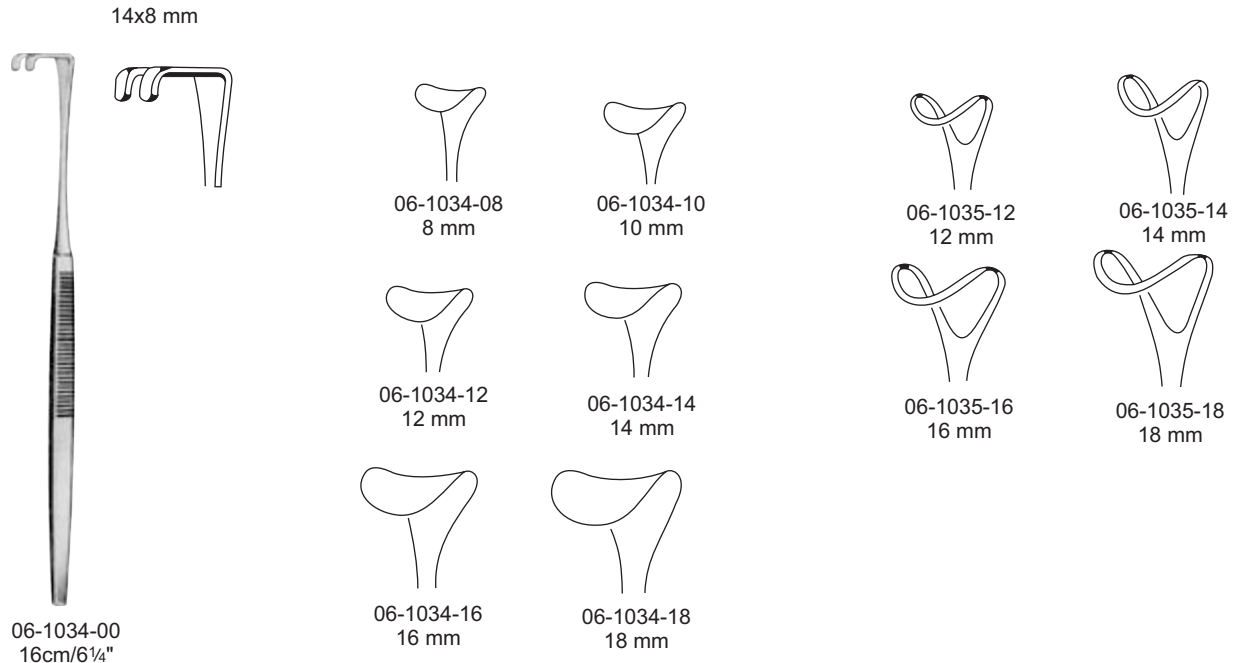

General Instruments

Wound and Trachea Retractors
Wund- und Luftröhre Retraktoren

Rétracteurs plaies et de la trachée
Heridas y tráquea Retractores

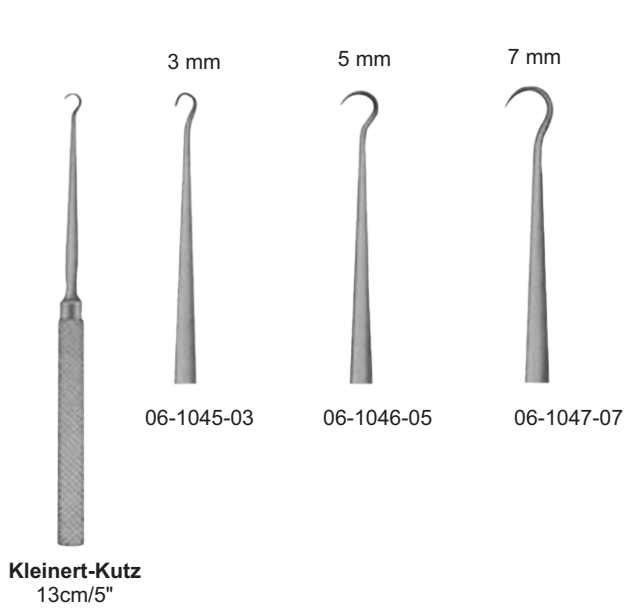

General Instruments

Retractors
Retraktoren

Rétracteurs
Retractoros

06



Malleable
formbar
malléable
maleable

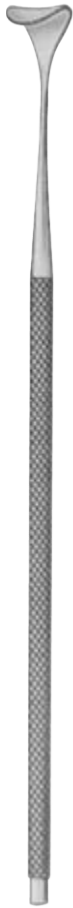

Gil-Vernet
24cm/9½"

8 mm 06-1053-08	06-1054-08
11 mm 06-1053-11	06-1054-11
15 mm 06-1053-15	06-1054-15
17 mm 06-1053-17	06-1054-17
20 mm 06-1053-20	06-1054-20
23 mm 06-1053-23	06-1054-23

Malleable
formbar
malléable
maleable



24cm/9½"

12x14 mm



Little
06-1055-20
20cm/8"



Love-(Morse)
25cm/10"

10 mm 06-1056-10
15 mm 06-1056-15
20 mm 06-1056-20
30 mm 06-1056-30
40 mm 06-1056-40
50 mm 06-1056-50

General Instruments

Wound and Trachea Retractors
Wund-und Luftröhre Retraktoren

Rétracteurs plaies et de la trachée
Heridas y tráquea Retractores

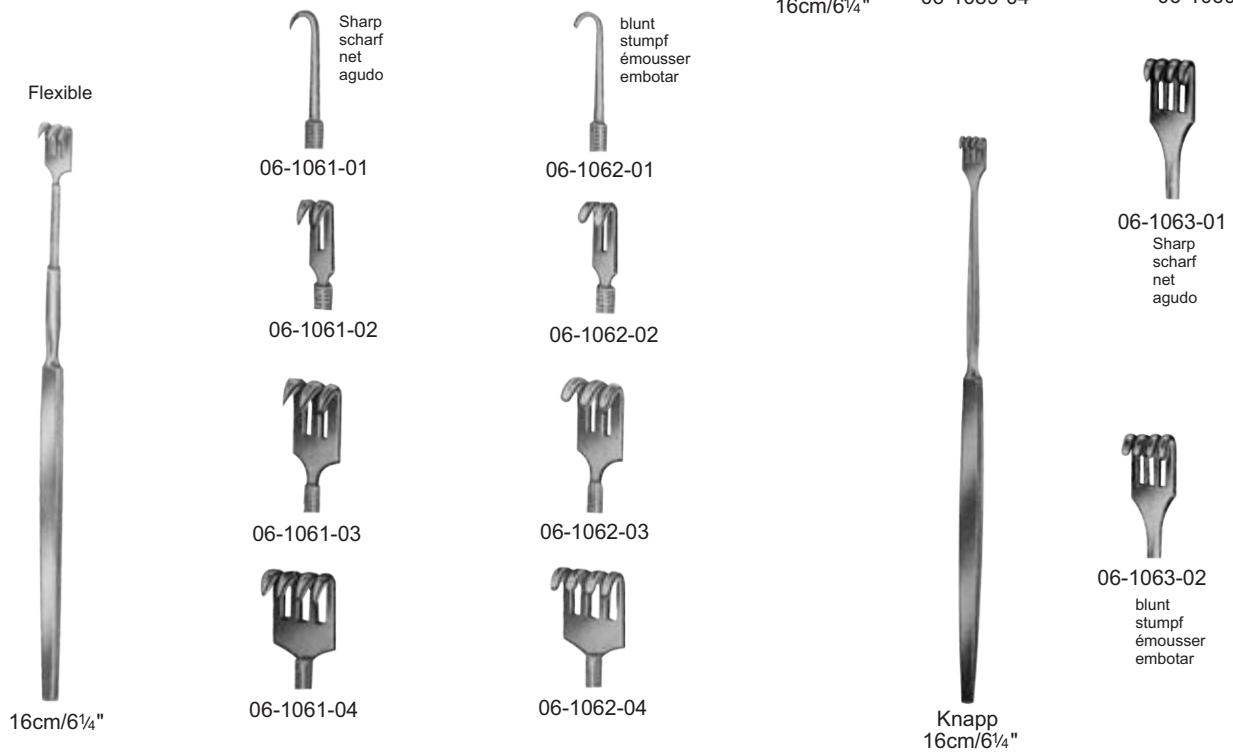
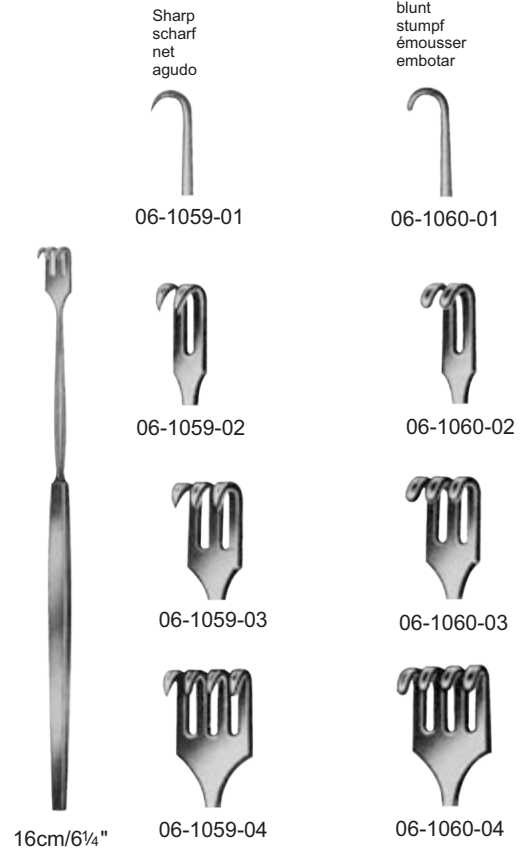

General Instruments

Trachea Retractors
Trachea Retraktoren

Rétracteurs trachée
tráquea Retractores



06



06-1064-13
13.5cm/5¼"



Jackson
06-1065-13
13cm/5"



Bergmann
06-1066-14
14cm/5½"



Iterson
16cm/6¼"



06-1067-16



06-1067-16



Meyerding
18cm/7"



06-1068-18
18x7 mm



06-1071-18
16x5 mm



06-1069-18
7x4 mm



06-1072-18
10x3 mm



06-1070-18
7x4 mm



06-1073-18



Volkman
11.5cm/4½"



Sharp
scharf
net
agudo

06-1074-02

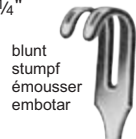

blunt
stumpf
émousser
embotar

06-1075-02



06-1074-03



06-1075-03



06-1074-04



06-1075-04



06-1074-06









06-1075-06

General Instruments

Wound and Vein Retractors
Wund- und Vein Retraktoren

Rétracteurs plaies et de la veine
Heridas y Vena Retractores

06

 Cushing 06-1076-18 20cm/8"	06-1076-08	8 mm	06-1077-08	 Cushing 06-1077-18 24cm/9 1/2"	06-1078-08	8 mm	06-1078-10	10 mm
	06-1076-10	10 mm	06-1077-10		06-1078-11	11 mm	06-1078-12	12 mm
	06-1076-12	12 mm	06-1077-12		06-1078-13	13 mm	06-1078-14	14 mm
	11-0158-14	14 mm	06-1077-14		06-1078-15	15 mm	06-1078-16	16 mm
	06-1076-16	16 mm	06-1077-16		06-1078-18	18 mm		
		18 mm						
 Konig 17cm/6 3/4"	06-1079-13	13x13 mm	 Rose 06-1080-13 13cm/5"	 Chile 06-1081-11 11cm/4 1/4"	 Luer 06-1082-11 11.5cm/4 1/2"			
	06-1079-16	13x16 mm				12x4 mm	20x6 mm	

General Instruments

Retractors
Retraktoren

Rétracteurs
Retradores

06

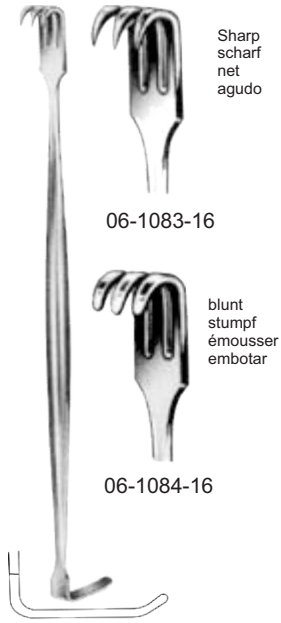

Senn-Miller
16cm/6¼"

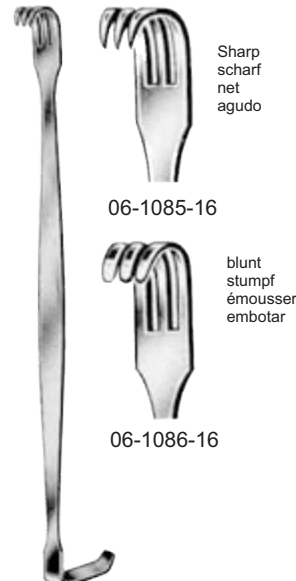

Baby-Senn-Miller
16cm/6¼"



Rangell-Davis
06-1087-14
14cm/5½"

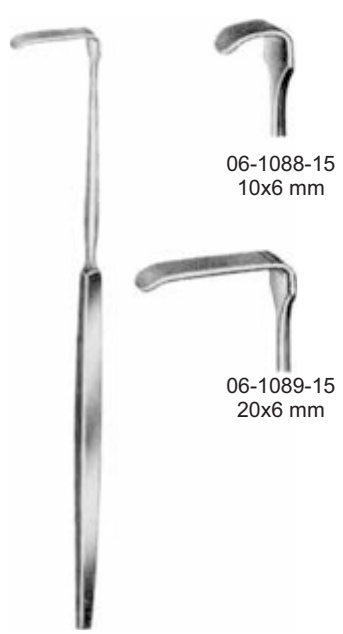

Senn-Green
15cm/6"

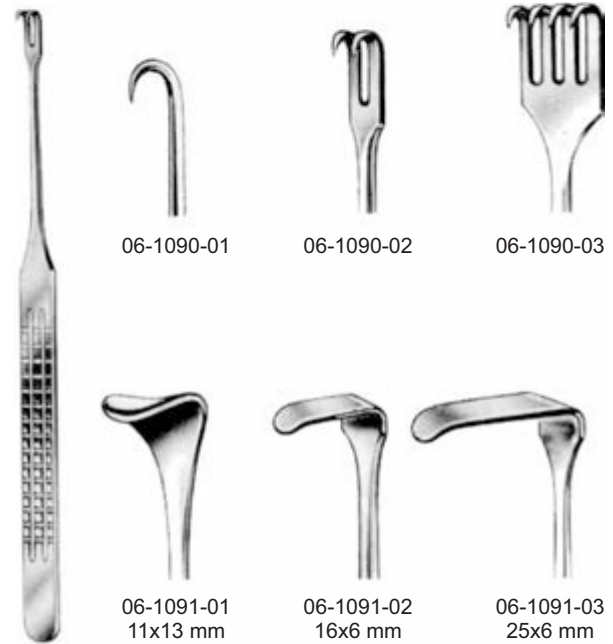

Langenbeck-Green
16cm/6¼"

General Instruments

Retractors and Tendon Sheath Hooks
Retraktoren und Sehnscheide Haken

Rétracteurs et Crochets gaine du tendon
Los retractoros y ganchos la vaina del tendón

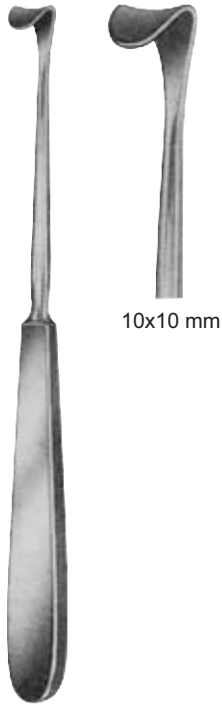

10x10 mm

Cushing-Kocher
06-1092-18
18cm/7"

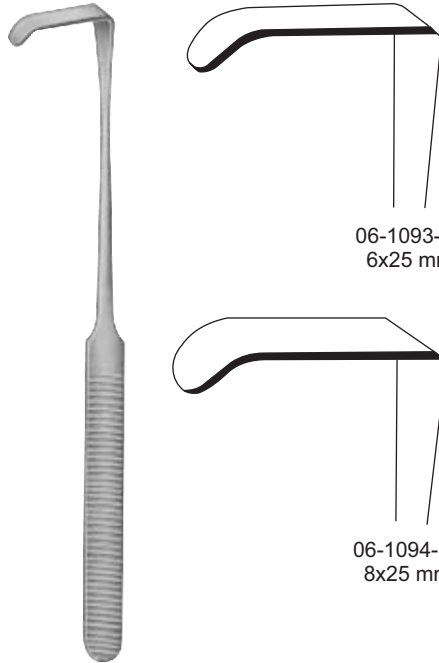

06-1093-17
6x25 mm

06-1094-17
8x25 mm

Langenbeck-Green
17cm/6¾"

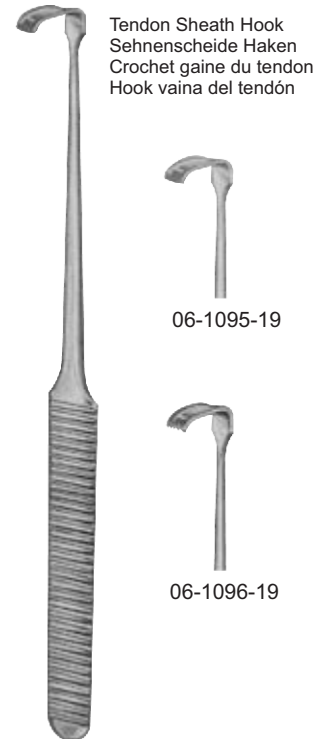

Tendon Sheath Hook
Sehnscheide Haken
Crochet gaine du tendon
Hook vaina del tendón

06-1095-19

06-1096-19

Strandell-Stille
19cm/7½"

Tendon Sheath Hook
Sehnscheide Haken
Crochet gaine du tendon
Hook vaina del tendón



06-1097-01



06-1097-02



06-1097-03

Klapp
17.5 cm/7"



Decompression Hook
Decompression Haken
Crochet de décompression
descompresión Hook

Cushing
06-1098-20
20cm/8"

General Instruments

Retractors
Retraktoren

Rétracteurs
Retractoros



06



Collin-Hartmann

Set	06-1099-00
14 cm/5½"	06-1099-01
16 cm/6"	06-1099-02



Roux

Set	06-1100-00
14 cm/5½" Fig. 1	06-1100-01
15 cm/6" Fig. 2	06-1100-02
17 cm/6¾" Fig. 3	06-1100-03



Baby-Roux
13 cm/5"

06-1101-13



Mini-Roux
14 cm/5½"

06-1102-14

37x40 mm

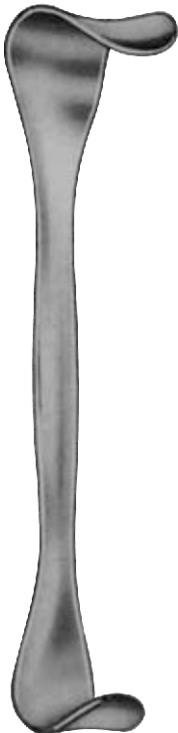

37x31 mm

Goelet
06-1103-19
19 cm/7½"



**Parker-Langenbeck
(US-Army)**
06-1104-21
21cm/8¼"

Set
setzen
fixer
establecer



Parker
06-1105-13
13.5 cm/5¼"

Set
setzen
fixer
establecer



Parker
06-1106-18
18 cm/7"

Set
setzen
fixer
establecer

General Instruments

Retractors
Retraktoren

Rétracteurs
Retractoros

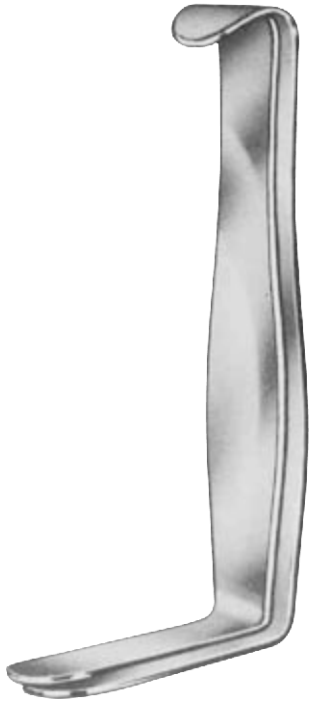

Parker-Mott
06-1107-16
16 cm/6¼"

Set
setzen
fixer
establecer



Farabeuf
06-1108-12
12 cm/4 "

Set
setzen
fixer
establecer



Farabeuf
06-1109-15
15 cm/6"

Set
setzen
fixer
establecer



Farabeuf
06-1110-01
8x10x100mm
06-1110-02
7x9x120mm
06-1110-03
11x14x120mm
06-1110-04
11x15x150mm
06-1110-05
21x15x150mm



Collin
06-1111-16
16.5 cm/6½"

Set
setzen
fixer
establecer



Mayo-Collin
06-1112-15
15 cm/6"

Set
setzen
fixer
establecer



Mathieu
06-1113-19
19 cm/7½"

Set
setzen
fixer
establecer

General Instruments

Retractors and Bone Retractors
Retraktoren und Bone Retraktoren

Rétracteurs et écarteurs à os
Separadores y Retractores hueso



06



Sharp
scharf
net
agudo

Volkman
06-1113-22
22 cm/8 3/4"



blunt
stumpf
émousser
embotar

Volkman
06-1114-22
22 cm/8 3/4"



Sharp
scharf
net
agudo

06-1115-23
23 cm/9"



blunt
stumpf
émousser
embotar

06-1116-23
23 cm/9"



Volkman
21,5cm/8 1/2"

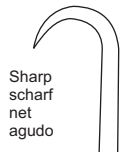

Sharp
scharf
net
agudo

06-1117-01



06-1117-02



06-1117-03



06-1117-04



06-1117-06



06-1117-08

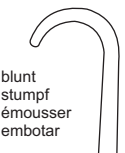

blunt
stumpf
émousser
embotar

06-1118-01



06-1118-02



06-1118-03



06-1118-04



06-1118-06



06-1118-08



semi-sharp
semi-scharfe
semi-forte
semi-fuerte

06-1119-01



06-1119-02



06-1119-03



06-1119-04



06-1119-06



06-1119-08

General Instruments

Retractors and Bone Retractors
Retraktoren und Bone Retraktoren

Rétracteurs et écarteurs à os
Separadores y Retractores hueso



Volkman
21 cm/8³/₄"

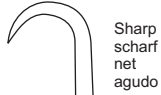

Sharp
scharf
net
agudo

06-1120-01



06-1120-02



06-1120-03



06-1120-04



06-1120-06

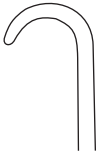

blunt
stumpf
émousser
embotar

06-1121-01



06-1121-02



06-1121-03



06-1121-04



06-1121-06

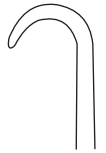

semi-sharp
semi-scharfe
semi-forte
semi-fuerte

06-1122-01



06-1122-02



06-1122-03



06-1122-04



06-1122-06



Sharp
scharf
net
agudo

06-1123-24
24.5 cm/9³/₄"

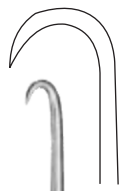

Sharp
scharf
net
agudo

Kocher
06-1124-21
21.5 cm/8¹/₂"

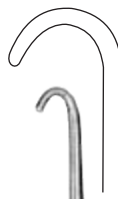

blunt
stumpf
émousser
embotar

Kocher
06-1125-21
21.5 cm/8¹/₂"

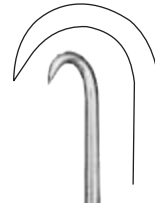

Sharp
scharf
net
agudo

Kocher
06-1126-21
21.5 cm/8¹/₂"

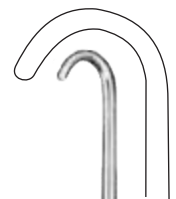

blunt
stumpf
émousser
embotar

Kocher
06-1127-21
21.5 cm/8¹/₂"

General Instruments

Retractors and Bone Retractors
Retraktoren und Bone Retraktoren

Rétracteurs et écarteurs à os
Separadores y Retractores hueso

06



Kocher
22 cm/8³/₄"

Sharp
scharf
net
agudo

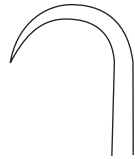

06-1128-01



06-1128-02



06-1128-03



06-1128-04



06-1128-06



06-1128-08

blunt
stumpf
émousser
embotar

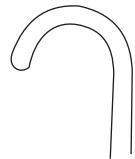

06-1129-01



06-1129-02



06-1129-03



06-1129-04



06-1129-06



06-1129-08

semi-sharp
semi-scharfe
semi-forte
semi-fuerte

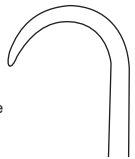

06-1130-01



06-1130-02



06-1130-03



06-1130-04



06-1130-06



06-1130-08

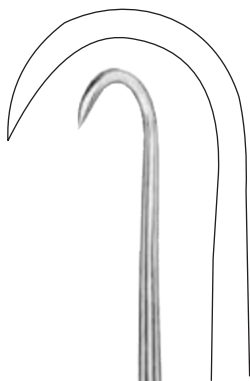

Sharp
scharf
net
agudo

06-1131-20
20 cm/8"

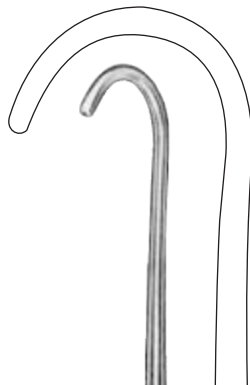

blunt
stumpf
émousser
embotar

06-1132-20
20 cm/8"

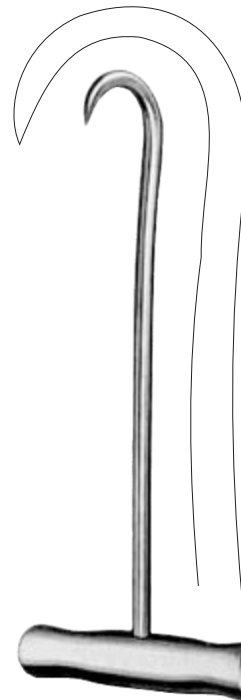

Sharp
scharf
net
agudo

06-1133-14
14 cm/5¹/₂"

General Instruments

Retractors
Retraktoren

Rétracteurs
Retractoros

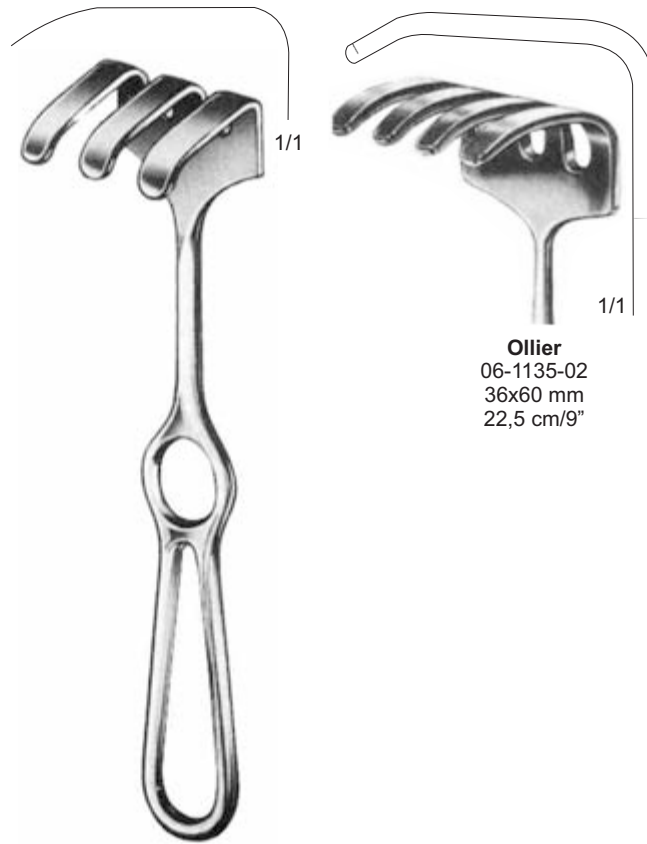

Ollier
06-1135-02
36x60 mm
22,5 cm/9"

Ollier
06-1134-01
36x30 mm
22,5 cm/9"



Murphy
19.5 cm/7 3/4"

Sharp
scharf
net
agudo



06-1136-02



06-1136-03



06-1136-04



06-1136-06

blunt
stumpf
émousser
embotar

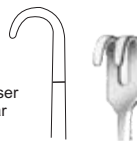

06-1137-02



06-1137-03



06-1137-04



06-1137-06

General Instruments

Retractors
Retraktoren

Rétracteurs
Retradores

06



33x20 mm

Wassmund
06-1138-20
20cm/8"



06-1139-02
40x50 mm

Israel
25cm/10"



06-1139-01
40x40 mm



06-1139-03
50x60 mm



06-1139-04
70x70 mm



46x55 mm

Koerte
23cm/9"

Vertical Handle
vertikale Griff
poignée verticale
asa vertical
06-1140-23

General Instruments

Retractors
Retraktoren

Rétracteurs
Retractoros



Koerte-Wagner
06-1141-28
28cm/11"



Koerte
23.5 cm/9¼"

Vertical Handle
vertikale Griff
poignée verticale
asa vertical

40x30 mm



blunt
stumpf
émousser
embotar
06-1143-23

Sharp
scharf
net
agudo
06-1142-23



06-1144-24
24cm/9½"

Vertical Handle
vertikale Griff
poignée verticale
asa vertical

50x25 mm



06-1145-25
25cm/10"

General Instruments

Retractors
Retraktoren

Rétracteurs
Retradores

06



Langenbeck

06-1146-01 22x6mm 21.5cm/8¼"
06-1146-02 44x13mm 21.5cm/8¼"
06-1146-03 64x25mm 21.5cm/8¼"



Langenbeck

21cm/8¼"

06-1147-01
55x20 mm
06-1147-02
60x20 mm
06-1147-03
63x20 mm



Langenbeck

21cm/8¼"

06-1148-01
35x7 mm
06-1148-02
35x10 mm
06-1148-03
35x15 mm
06-1148-04
60x20 mm



Lahey

19cm/7½"

06-1149-19
28x6 mm



22.5cm

Sauerbruch

06-1150-01 45x15 mm
06-1150-02 60x23 mm
06-1150-03 75x20 mm



Langenbeck

21cm/8¼"

06-1151-01 30x11 mm 11-0374-01
06-1151-02 30x14 mm 11-0374-02
06-1151-03 33x14 mm
06-1151-04 30x16 mm 11-0374-04
06-1151-05 40x11 mm 11-0374-05
06-1151-06 42x13 mm
06-1151-07 50x11 mm 11-0374-07



Langenbeck

22cm/8¾"

General Instruments

Retractors
Retraktoren

Rétracteurs
Retractors

06-1152-01 40x10 mm
06-1152-02 40x15 mm
06-1152-03 40x20 mm



Kocher
22cm/8¾"

06-1153-01
19x12 mm
06-1153-02
21x15 mm



Kocher
19cm/7½"

06-1154-01 25x06 mm
06-1154-02 25x08 mm
06-1154-03 35x08 mm
06-1154-04 35x11 mm
06-1154-05 35x15 mm
06-1154-06 42x11 mm
06-1154-07 55x11 mm
06-1154-08 70x14 mm
06-1154-09 80x12 mm
06-1154-10 80x16 mm

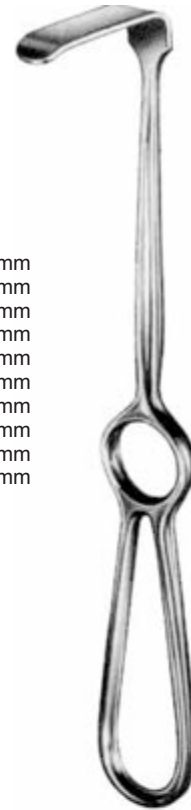

Kocher-Langenbeck
21.5cm/8½"



Czerny
06-1155-18
18 cm/7"



67x17cm

Casper
06-1156-21
21.5cm/8½"

General Instruments

Retractors
Retraktoren

Rétracteurs
Retractoros

06

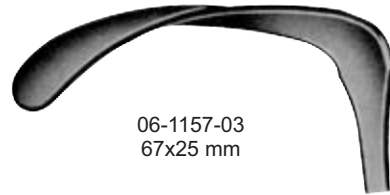

06-1157-03
67x25 mm



06-1157-01
22x15 mm

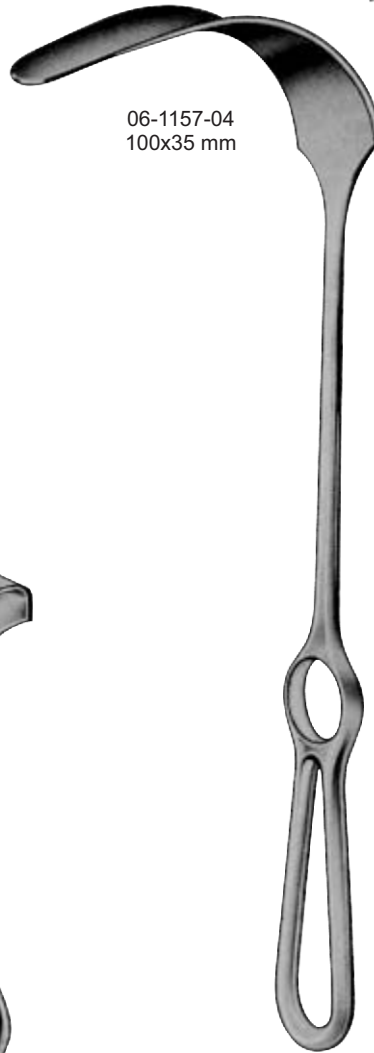

06-1157-04
100x35 mm

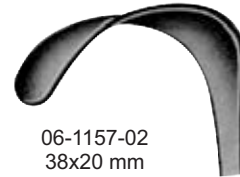

06-1157-02
38x20 mm



- 06-1158-01
40x18 mm
- 06-1158-02
60x20 mm
- 06-1158-03
60x25 mm
- 06-1158-04
75x30 mm
- 06-1158-05
75x40 mm

Kocher
23cm/9"

Kocher-Wagner
28cm/11"



- 06-1159-01
60x20 mm
- 06-1159-02
80x30 mm
- 06-1159-03
100x30 mm
- 06-1159-04
120x30 mm
- 06-1159-05
140x30 mm
- 06-1159-06
140x40 mm

Heosel
25cm/10"

General Instruments

Retractors
Retraktoren

Rétracteurs
Retradores

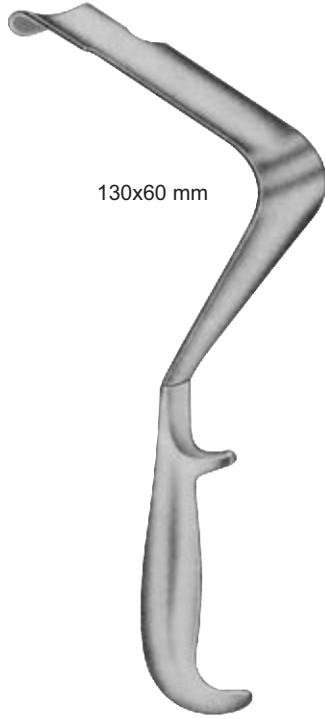

130x60 mm

St. Marks
06-1161-29
29cm/11½"

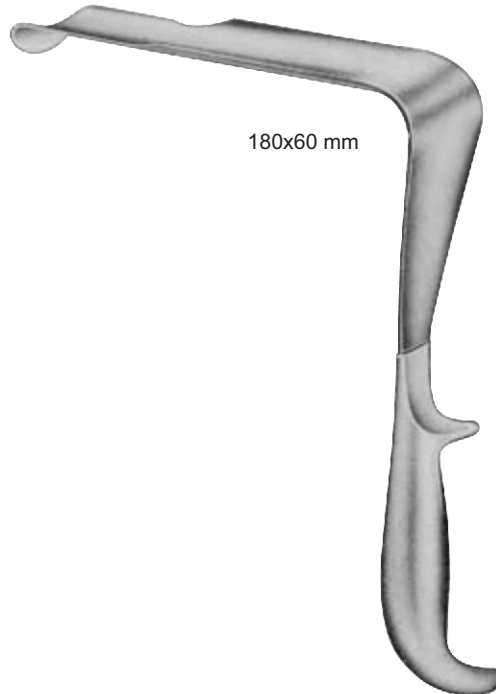

180x60 mm

St. Marks
06-1162-32
32.5cm/12¾"

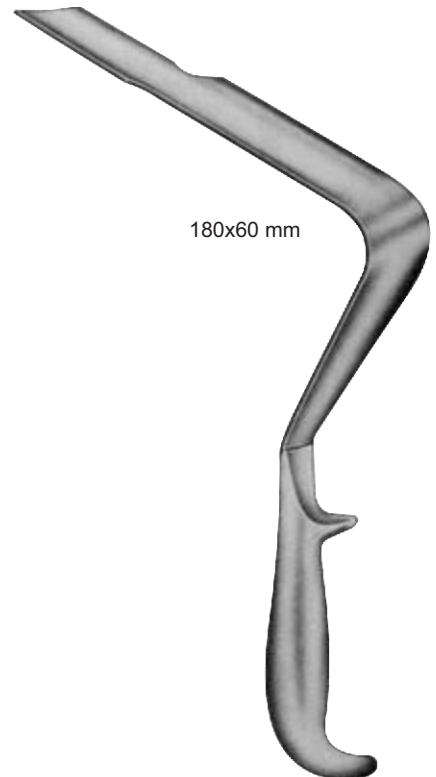

180x60 mm

St. Marks
06-1163-33
33cm/13"



06-1164-01
70x40 mm
06-1164-02
70x50 mm
06-1164-03
70x65 mm

Morris
21cm/8¼"



06-1165-01
32x50 mm/38x50mm
06-1165-02
45x50 mm/50x50mm
06-1165-03
65x50 mm/38x50mm

Morris
24cm/9½"

General Instruments

Retractors and Meniscus Retractors
Retraktoren und Meniskus Retraktoren

Rétracteurs Rétracteurs et méniscales
Separadores y Retractores de menisco



06



38x9 mm

Meniscus Retractors
Ecarteurs ménisque
Retradores de menisco

06-1166-21
21cm/8¼"



40x5 mm

Blount
06-1167-18
18cm/7"

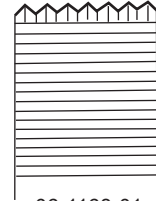

06-1168-01
15x15 mm

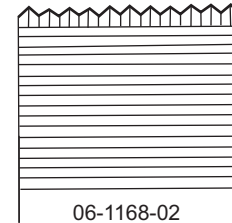

06-1168-02
15x23 mm

Crawford
19cm/7½"



Green
06-1169-22
22cm/8½"



Middeldorpf

06-1170-01



14x17 mm
21.5cm/8½"

06-1171-01

06-1170-02



20x22 mm
22cm/8¾"

06-1171-02

06-1170-03



26x30 mm
23.5cm/9¼"

06-1171-03



Middeldorpf

General Instruments

Retractors
Retraktoren

Rétracteurs
Retractoros

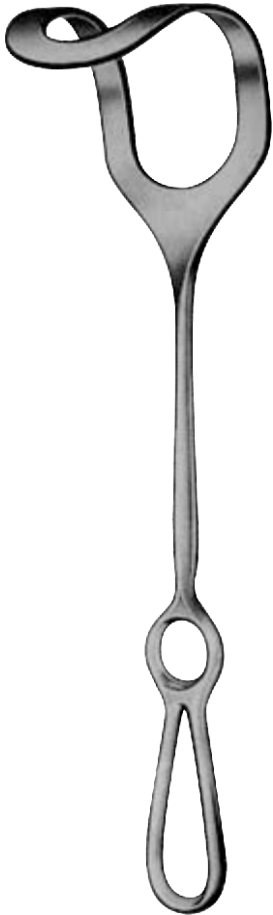

Middeldorpf
25.5cm/10"

06-1172-01
45x45 mm
06-1172-02
45x50 mm
06-1172-03
55x70 mm



Richardson
26cm/10¼"

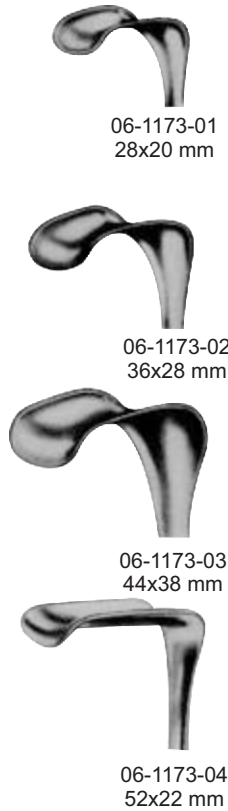

06-1173-01
28x20 mm

06-1173-02
36x28 mm

06-1173-03
44x38 mm

06-1173-04
52x22 mm

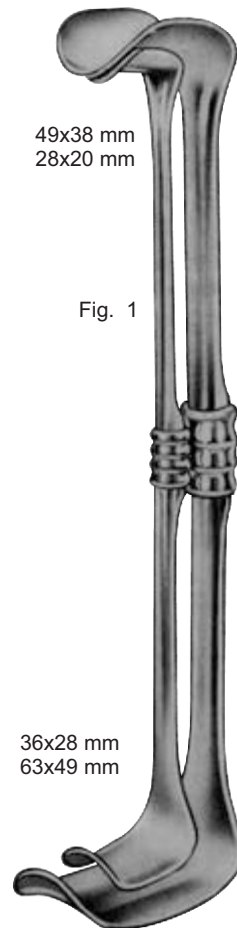

49x38 mm
28x20 mm

Fig. 1

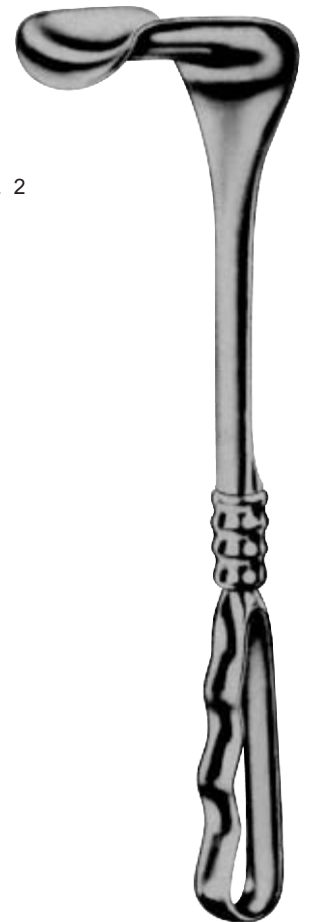

Fig. 2

36x28 mm
63x49 mm

Richardson-Eastman

Set 06-1174-00
setzen
fixer
establecer

Fig. 1
26cm/10¼" 06-1174-01

Fig. 2
28cm/11" 06-1174-02

Kelly
26cm/10¼"

06-1175-01
40x50 mm
06-1175-02
50x65 mm
06-1175-03
65x75 mm
06-1175-04
75x90 mm

General Instruments

Retractors
Retraktoren

Rétracteurs
Retradores



06

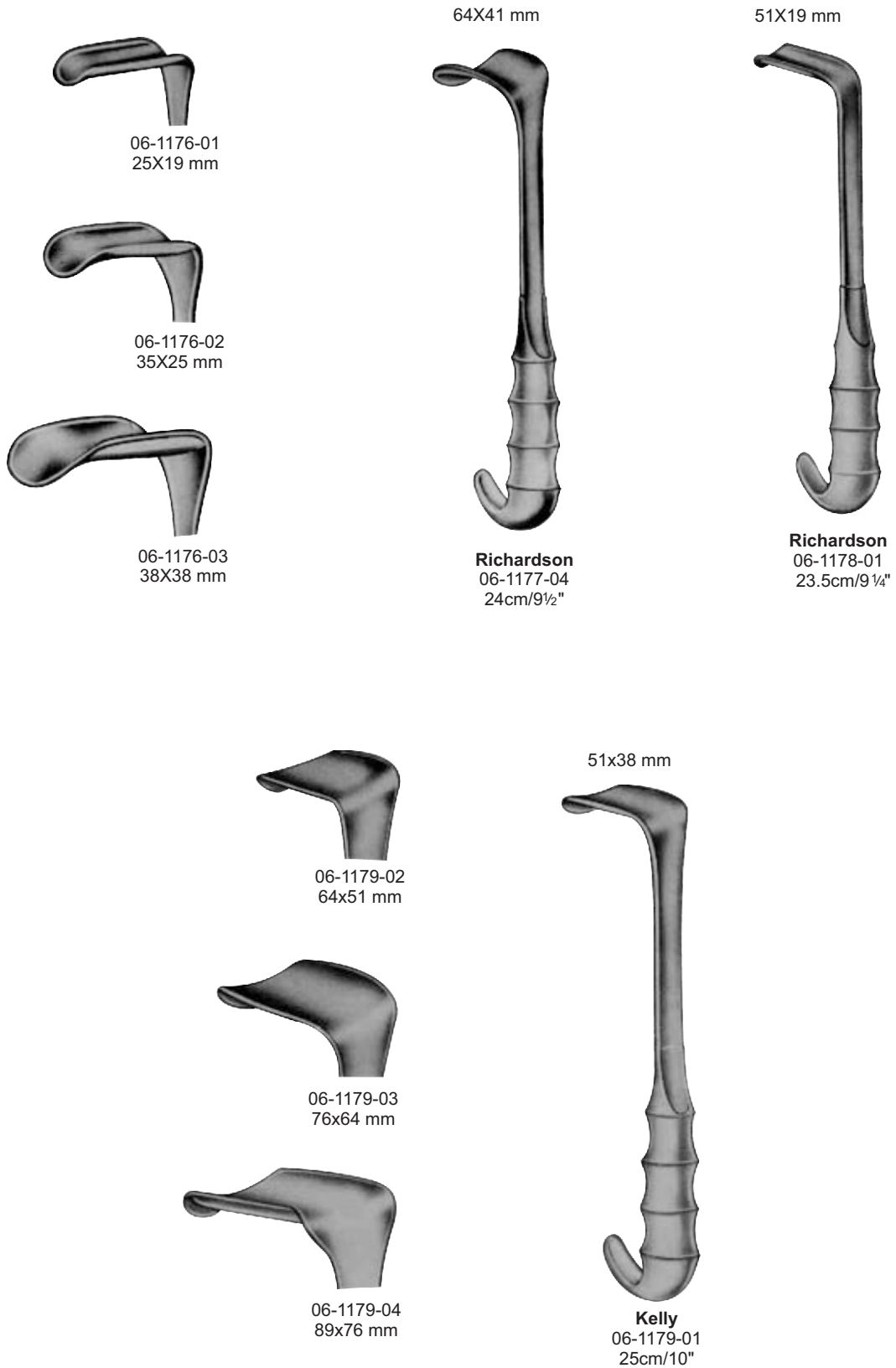

General Instruments

Retractors
Retraktoren

Rétracteurs
Retradores

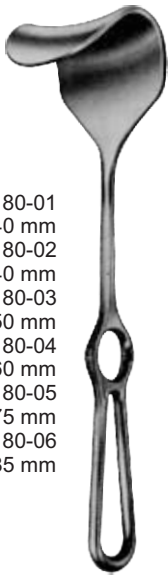

06-1180-01
40x40 mm
06-1180-02
45x40 mm
06-1180-03
45x50 mm
06-1180-04
45x60 mm
06-1180-05
45x75 mm
06-1180-06
65x85 mm

Fritsch
24cm/9½"

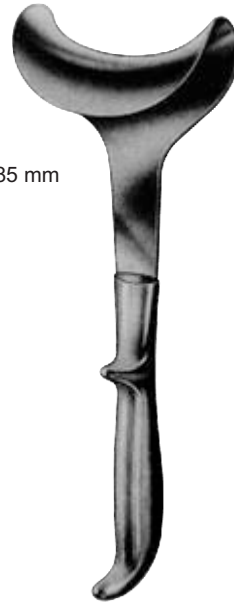

50x85 mm

Doyen
06-1181-25
25cm/10"

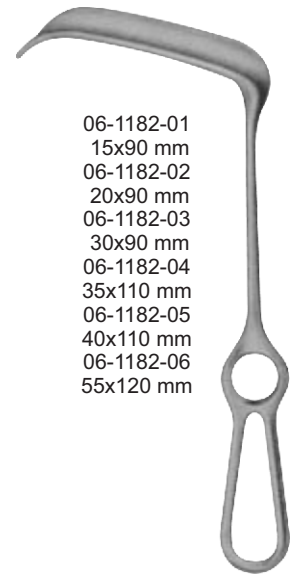

06-1182-01
15x90 mm
06-1182-02
20x90 mm
06-1182-03
30x90 mm
06-1182-04
35x110 mm
06-1182-05
40x110 mm
06-1182-06
55x120 mm

Doyen-Stille
24cm/9½"



70x25 mm

Kocher
06-1183-22
22.5cm/9"

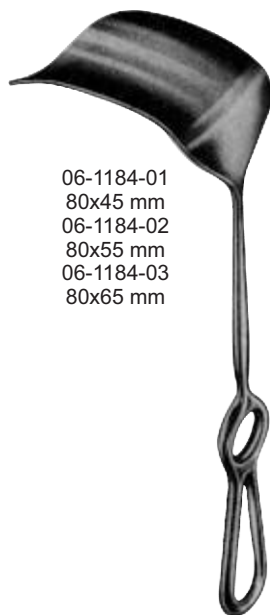

06-1184-01
80x45 mm
06-1184-02
80x55 mm
06-1184-03
80x65 mm

Kocher
25cm/10"



64x60 mm

Tuffier
06-1185-23
23cm/9"

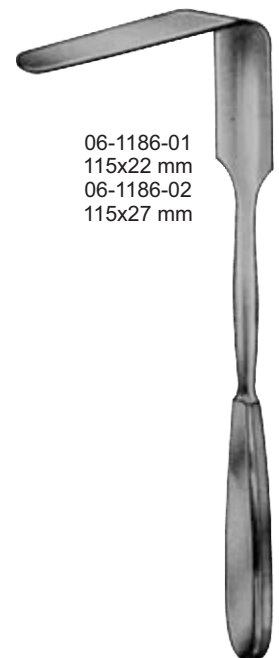

06-1186-01
115x22 mm
06-1186-02
115x27 mm

Simon
28cm/11"

General Instruments

Retractors and Liver Retractors
Retraktoren und Leber Retraktoren

Rétracteurs Rétracteurs et du foie
Separadores y Retractores hepáticos



06

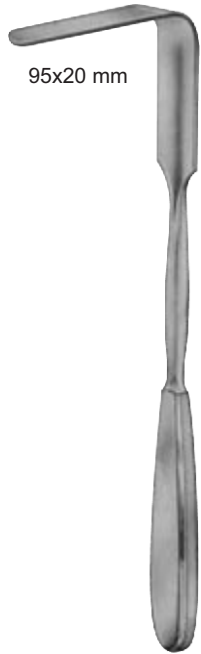

95x20 mm

Tuebingen
06-1187-28
28cm/11"

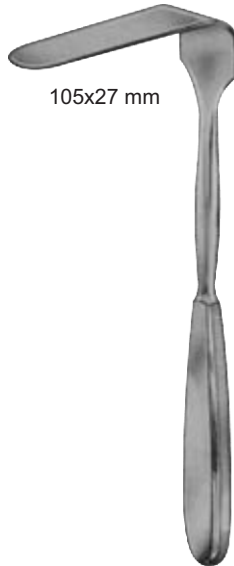

105x27 mm

Martin
06-1188-26
26cm/10¼"

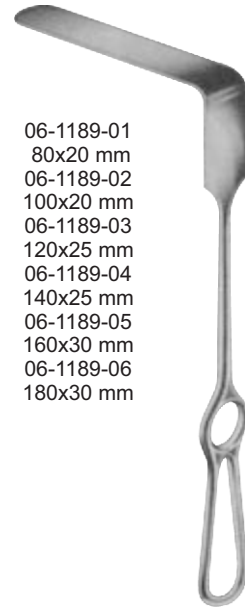

06-1189-01
80x20 mm
06-1189-02
100x20 mm
06-1189-03
120x25 mm
06-1189-04
140x25 mm
06-1189-05
160x30 mm
06-1189-06
180x30 mm

Brunner
25cm/10"



06-1190-01
80x20 mm
06-1190-02
100x20 mm
06-1190-03
120x25 mm
06-1190-04
140x25 mm
06-1190-05
160x30 mm
06-1190-06
180x30 mm

Brunner
25cm/10"



90x50 mm

06-1191-01
95x35 mm
06-1191-02
120x50 mm
06-1191-03
155x50 mm

Mikulicz
26cm/10¼"



90x50 mm

Mikulicz
06-1192-26
26cm/10¼"

General Instruments

Retractors
Retraktoren

Rétracteurs
Retradores



06-1193-01
160x38 mm
06-1193-02
160x57 mm
06-1193-01
190x38 mm
06-1193-02
190x57 mm

Kelly
27cm/10½"



Polloson
06-1194-27
27cm/10½"



Polloson
06-1195-27
27cm/10½"



06-1196-03
115x65 mm

06-1196-02
108x43 mm

06-1196-01
82x22 mm

Coryllos
23.0cm/9"



06-1197-25
125x37 mm

Sauerbruch
25cm/10"

General Instruments

Retractors and Lung Spatulas
Retraktoren und Lungenforschung Spatel

Rétracteurs Spatules et du poumon
Los retractoros y espátulas de pulmón



06

19 mm



Deaver
06-1198-01
18 cm/7"

22 mm



Deaver
06-1199-02
21.5 cm/8½"

25 mm



Deaver
06-1200-03
23 cm/9"

25 mm



Deaver
06-1201-04 30cm/12"
06-1201-05 33cm/13"
06-1201-06 36cm/14"

06-1202-07
38 mm
06-1202-08
50 mm
06-1202-09
75 mm

Deaver
30 cm/12"



Deaver Grip-Handle
06-1203-01 25 mm
06-1203-02 38 mm
06-1203-03 50 mm
06-1203-04 75 mm
30 cm/12"



Harrington-Baby
06-1204-01
25 cm/10"
24x70 mm
Harrington
06-1204-02
06-1204-03
32 cm/12½"
40x127 mm
62x127 mm
Harrington
06-1204-04
29.5 cm/11½"
64x175 mm

General Instruments

Abdominal and Intestinal Spatulas
Bauch-und Darm-Spatel

Spatules abdominale et intestinale
Espátulas abdominales e intestinales

06



Kader
06-1211-01 20mm
06-1211-02 30mm
06-1211-03 40mm
27cm/10 1/2"



06-1212-01
25.5cm/10"
45 mm
06-1212-02
27.5cm/10 3/4"
60 mm

Leriche



Malleable
formbar
malléable
maleable

- 06-1213-01 20 mm
- 06-1213-02 25 mm
- 06-1213-03 30 mm
- 06-1213-04 35 mm
- 06-1213-05 40 mm
- 06-1213-06 45 mm
- 06-1213-07 50 mm
- 06-1213-08 64 mm
- 06-1213-09 76 mm
- 06-1213-10 102 mm
33cm/13"

Malleable
formbar
malléable
maleable



Malleable
formbar
malléable
maleable

- 06-1215-01
200x6 mm
- 06-1215-02
200x8 mm
- 06-1215-03
200x10 mm
- 06-1215-04
200x12 mm
- 06-1215-05
200x17 mm
- 06-1215-06
200x20 mm
- 06-1215-07
200x25 mm
- 06-1215-08
250x25 mm

Tuffier
06-1214-20
20 cm/8"
17x25 mm



20cm/8"

Malleable
formbar
malléable
maleable

- 06-1216-01
280x25/30 mm
- 06-1216-02
300x37/45 mm
- 06-1216-03
300x40/50 mm



Haberer



Reverdin
06-1217-28
28 cm/11"

General Instruments

Retractors
Retraktoren

Rétracteurs
Retractoros

06



Meyering

06-1205-01
50x16 mm 20cm/8"
06-1205-02
75x25 mm 22cm/8¾"
06-1205-03
90x50 mm 24cm/9½"



Zenker

06-1206-01 25cm/10" 35x08 mm
06-1206-02 26cm10¼" 60x12 mm
06-1206-03 27.5cm/10¾" 75x12 mm

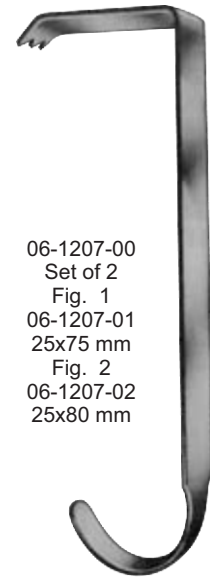

Hibbs
24cm/9½"

06-1207-00
Set of 2
Fig. 1
06-1207-01
25x75 mm
Fig. 2
06-1207-02
25x80 mm



06-1208-01
45x25 mm
06-1208-02
73x28 mm
06-1208-03
82x28 mm

Heaney
27cm/10½"

46 mm



Kuemmel
06-1209-33
33cm/13"

120x47 mm

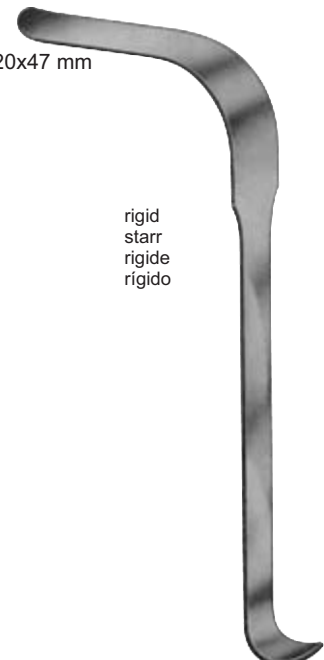

rigid
starr
rigide
rigido

Koerte
06-1210-28
28cm/11"

General Instruments

Retractors
Retraktoren

Rétracteurs
Retractoros



Davidson
16cm/6¼"

75x50 mm
75x90 mm

06-1218-01
06-1218-02



Cooley
06-1219-01
21.5cm/8½"

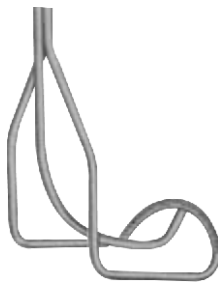

Cooley
06-1220-01
21.5cm/8½"



Cooley
06-1220-02
23cm/9"



Ross
27cm/10½"

- Fig. 1 06-1222-01 13x13 mm
- Fig. 2 06-1222-02 14x12 mm
- Fig. 3 06-1222-03 18x18 mm
- Fig. 4 06-1222-04 20x20 mm
- Fig. 5 06-1222-05 22x18 mm
- Fig. 6 06-1222-06 26x24 mm

General Instruments

Retractors for Maxillofacial Surgery
Retraktoren für Kiefer-und Gesichtschirurgie

Rétracteurs pour la chirurgie maxillo-faciale
Los retractoros para cirugía maxilofacial



06

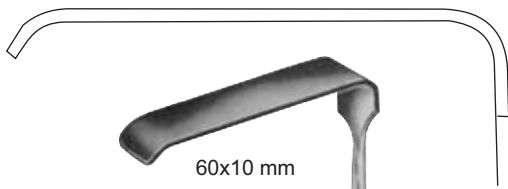

60x10 mm



Kirsch
06-1223-01
20cm/8"



60x10 mm



Kirsch
06-1224-02
20cm/8"



Set
setzen
fixer
establecer
06-1225-00

06-1225-01
24.5cm/10"

06-1225-02
24.5cm/10"

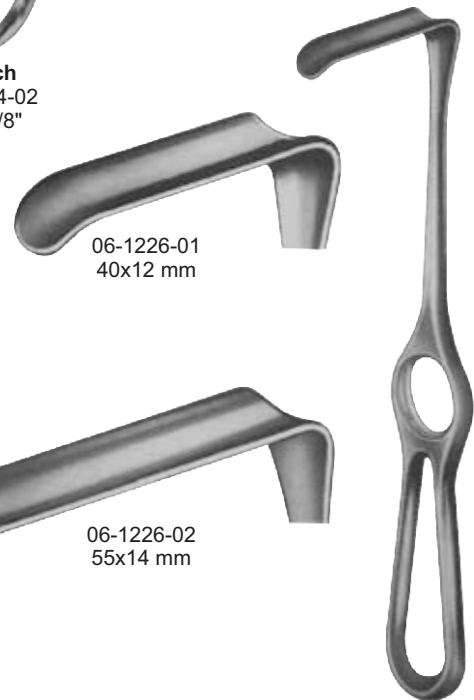

06-1226-01
40x12 mm

06-1226-02
55x14 mm

Dockhorn
20cm/8"

General Instruments

Retractors for Maxillofacial Surgery
Retraktoren für Kiefer-und Gesichtschirurgie

Rétracteurs pour la chirurgie maxillo-faciale
Los retractoros para cirugía maxilofacial

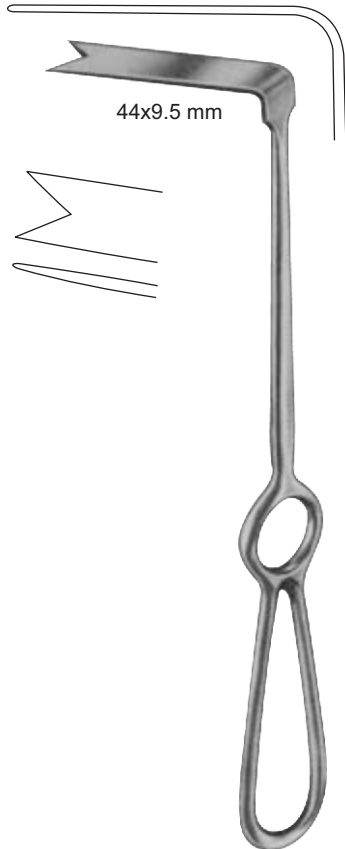

Spina-Nalis
06-1227-01
22 cm/8¾"

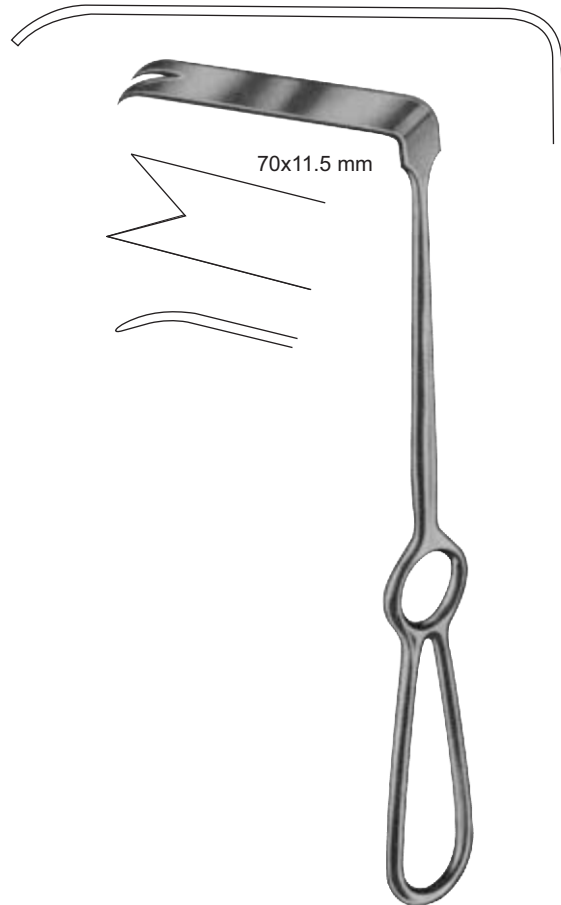

Ramus
06-1228-02
22 cm/8¾"



Obwegeser
06-1229-15
15.5 cm/6"



Obwegeser
06-1230-16
16 cm/6¼"

General Instruments

Retractors for Maxillofacial Surgery
Retraktoren für Kiefer-und Gesichtschirurgie

Rétracteurs pour la chirurgie maxillo-faciale
Los retractoros para cirugía maxilofacial



06

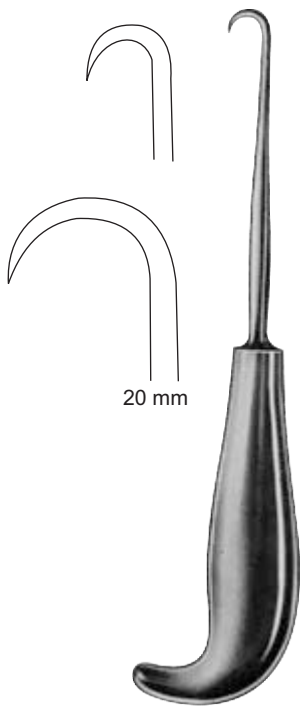

06-1231-10 10 mm
06-1231-20 20 mm
19cm/7½"



Dingman
06-1232-17
17.5cm/7"



Soeresen-Hein
06-1233-17
17.5cm/7"



Dingman
06-1234-21
21cm/8¼"



06-1235-18
18.5cm/7 "

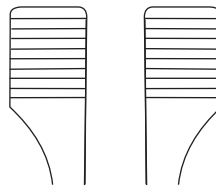

Tessier
06-1236-01
15cm/6"



Tessier
06-1236-02
15cm/6"



Dingman
06-1237-00

General Instruments

Retractors for Maxillofacial Surgery
Retraktoren für Kiefer-und Gesichtschirurgie

Rétracteurs pour la chirurgie maxillo-faciale
Los retractoros para cirugía maxilofacial

06



Obwegeser-Freer
06-1238-21
21cm/8¼"

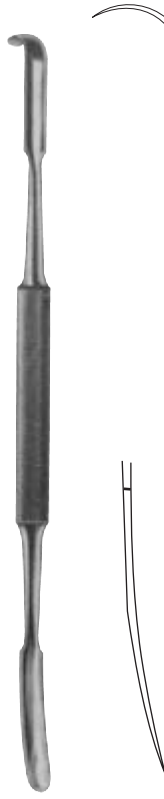

Obwegeser-Freer
06-1239-20
20.5cm/8"



Obwegeser
06-1240-17
17.5cm/7"



Obwegeser
20cm/8"



06-1241-05
5 mm



06-1241-08
8 mm



06-1241-09
9 mm



Obwegeser
17.5cm/7"



06-1242-06
6 mm



06-1242-07
7 mm



06-1242-09
9 mm



06-1242-11
11 mm



Dingman
06-1243-18
18cm/7"



Obwegeser
06-1244-23
23.5cm/9¼"
10 mm

General Instruments

Osteotome for Maxillofacial Surgery
 Osteotome für Kiefer-und Gesichtschirurgie

Ostéotome pour Chirurgie Maxillo-Faciale
 Osteotomo de Cirugía Maxilofacial



06



Tessier
 20.5cm/8"

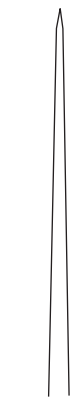

06-1245-10
 10 mm



06-1246-10
 10 mm



Obwegeser
 06-1247-01
 18.5cm/7 1/4"



Obwegeser
 06-1248-02
 18.5cm/7 1/4"



06-1249-07
 7 mm
 21.5cm/8 1/2"



06-1250-10
 10 mm
 21.5cm/8 1/2"



15cm/6"



06-1251-02
 2.5 mm



06-1251-04
 4 mm



Bowdler-Henry's
 06-1252-16
 16.5cm/6 1/2"



Gillies
 06-1253-21
 21cm/8 1/4"



Gillies
 06-1254-21
 21cm/8 1/4"

General Instruments

Awls for Maxillofacial Surgery
Ahlen für Kiefer-und Gesichtschirurgie

Alènes pour Chirurgie Maxillo-Faciale
Punzones de Cirugia Oral y Maxilofacial



Sanders-Brown
06-1255-30
30cm/12"



Sanders-Brown
06-1256-29
29cm/11½"



Obwegeser
06-1257-14
14cm/5½"



Obwegeser
06-1258-23
23cm/9"



Obwegeser
06-1259-18
18cm/7"



Kelsey-Fry
06-1260-16
15cm/6"



Kelsey-Fry
06-1261-18
18cm/7"



Mershon
06-1262-14
14.5cm/5½"

Band Pusher
Pusher Band

General Instruments

Retractors
Retraktoren

Rétracteurs
Retractoros



06



Bose



Finsen



Finsen

Sharp
scharf
net
agudo

blunt
stumpf
émousser
embotar

Sharp
scharf
net
agudo

cm	in					
5	2		06-1263-05	06-1264-05	06-1265-05	
7	2¾"	11-0740-07	06-1263-07	06-1264-07	06-1265-07	Blunt

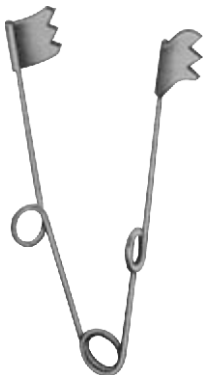

Allport

06-1267-09
9.5cm/3¾"



Alm

blunt
stumpf
émousser
embotar

Sharp
scharf
net
agudo

cm	in		cm	in		
8.5	3½"	06-1266-08	7	2¾"	06-1268-07	06-1269-07
11.5	4½"	06-1266-11	10	4	06-1268-10	06-1269-10

General Instruments

Retractors
Retraktoren

Rétracteurs
Retractoros



Sharp
scharf
net
agudo

Holzheimer

blunt
stumpf
émousser
embotar

06-1270-10 10 cm/4" 06-1271-10



Sharp
scharf
net
agudo

Jansen

blunt
stumpf
émousser
embotar

06-1272-10 10.5 cm/4¼" 06-1273-10



Sharp
scharf
net
agudo

Jansen-Deep

blunt
stumpf
émousser
embotar

06-1274-10 10.5 cm/4¼" 06-1275-10



Belucci

06-1276-11 11.5cm/4½"
06-1276-13 13cm/5"



Belucci

06-1277-11
06-1277-13

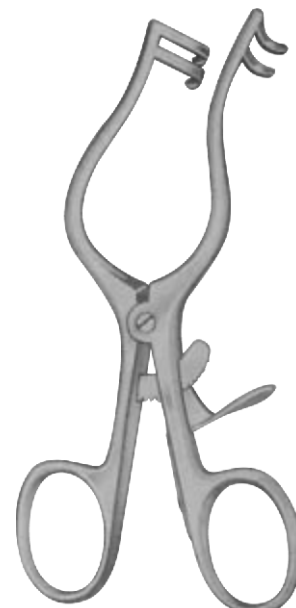

Sharp
scharf
net
agudo

Plester

blunt
stumpf
émousser
embotar

06-1278-13 13 cm/5" 06-1279-13

General Instruments

Retractors
Retraktoren

Rétracteurs
Retradores



06



Sharp
scharf
net
agudo

Weitlaner

blunt
stumpf
émousser
embotar

06-1281-10



Sharp
scharf
net
agudo

Weitlaner

blunt
stumpf
émousser
embotar

06-1282-13

06-1283-13

06-1282-16

06-1283-16



Weitlaner-Wullstein

Sharp
scharf
net
agudo

blunt
stumpf
émousser
embotar

06-1284-13

06-1285-13

06-1284-16

06-1285-16

10.5 cm/4¼"
13 cm/5"
16.5 cm/6½"

06-1280-10



Mollison
06-1286-15
15 cm/6"

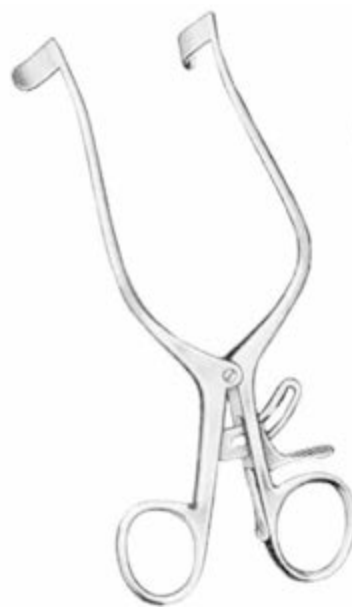

Tuebinger-Modell
06-1287-16
16 cm/6¼"



Henner(Lempert)
06-1288-12
12 cm/4½"

Complete with 2 pairs of blades and centre blade
Komplett mit 2 Paar Klängen und mittlere Klängen
Livré avec 2 paires de les lames et les lames centre
Completo con 2 pares de cuchillas y la cuchilla centro

General Instruments

Retractors
Retraktoren

Rétracteurs
Retractoros

Complete with 3 Central blades
Komplett mit 3 Central Klängen
Livré avec 3 lames centrales
Completo con 3 cuchillas centrales



Sharp
scharf
net
agudo

Henley

blunt
stumpf
émousser
embotar

06-1289-16 16.5 cm/6½" 06-1290-16

Central blades, only
Zentral Klängen, nur
Lames centrales, ne
Hojas centrales, sólo



06-1291-19
16x19 mm

06-1291-25
16x25 mm

06-1291-32
16x32 mm

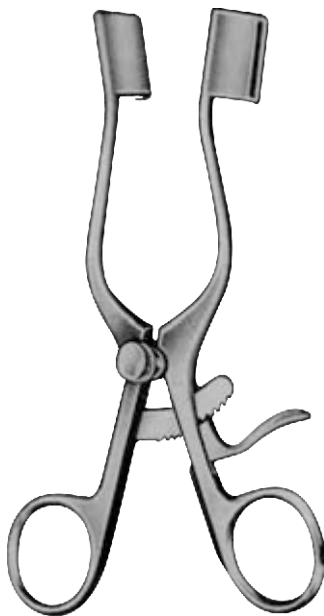

Weitlaner-Baby

13 cm/5"
16 cm/6¼" 06-1292-13



Sharp
scharf
net
agudo

Milligan

blunt
stumpf
émousser
embotar

06-1293-13 06-1294-13



Sharp
scharf
net
agudo

Cone (Adson-Baby)

blunt
stumpf
émousser
embotar

06-1295-13 06-1296-13
06-1295-16 06-1296-16

General Instruments

Retractors
Retraktoren

Rétracteurs
Retractoros



06



Weitlaner

20 cm/8"
25 cm/10"

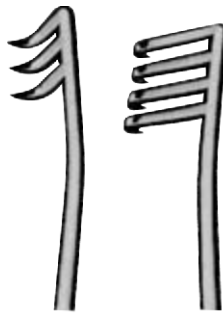

3x4 Teeth

Sharp
scharf
net
agudo

06-1297-20
06-1297-25

blunt
stumpf
émousser
embotar

06-1298-20
06-1298-25

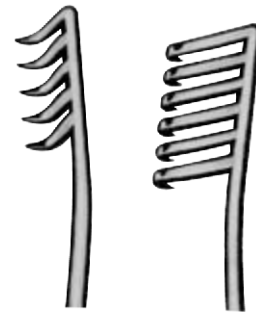

5x6 Teeth

Sharp
scharf
net
agudo

06-1299-25

blunt
stumpf
émousser
embotar

06-1300-25



Adson

Sharp
scharf
net
agudo

20 cm/8" 06-1301-20
26 cm/10¼" 06-1301-26

blunt
stumpf
émousser
embotar

06-1302-20
06-1302-26



Anderson-Adson

Sharp
scharf
net
agudo

06-1303-20

blunt
stumpf
émousser
embotar

06-1304-20



Cone

Sharp
scharf
net
agudo

06-1305-20
06-1305-26

blunt
stumpf
émousser
embotar

06-1306-20
06-1306-26

General Instruments

 Retractors
 Retraktoren

 Rétracteurs
 Retractores

Travers
 06-1307-21
 21 cm/8¼"

Jaws Depth

25 mm
 44 mm

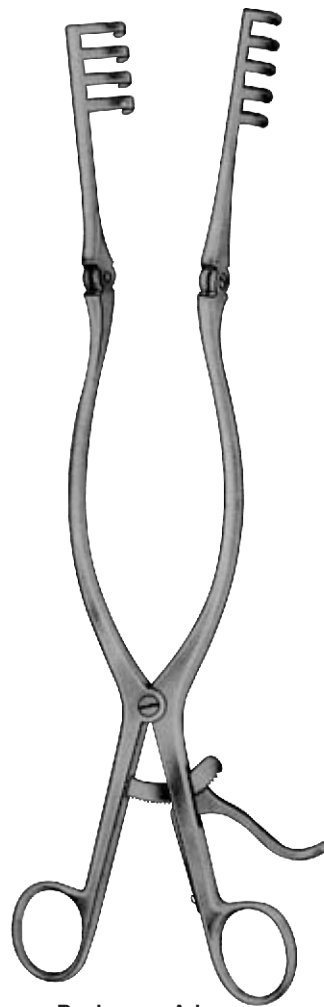

Beckmann-Adson

31 cm/12¼"

Sharp
 scharf
 net
 agudo

06-1308-01
 06-1308-02

blunt
 stumpf
 émousser
 embotar

06-1309-01
 06-1309-02



Adson
 27 cm/10½"

Sharp
 scharf
 net
 agudo

06-1310-27

blunt
 stumpf
 émousser
 embotar

06-1311-27

General Instruments

Retractors
Retraktoren

Rétracteurs
Retradores



06

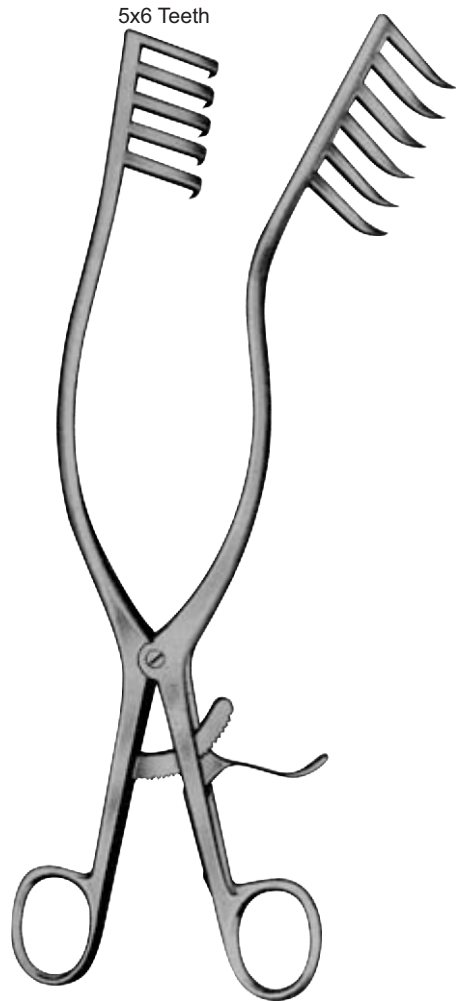

5x6 Teeth

Sharp
scharf
net
agudo

Adson

blunt
stumpf
émousser
embotar

06-1312-27 27cm/10½" 06-1313-27



Beckmann

06-1314-01 10mm 14cm/5½"
06-1314-02 12mm 17cm/6¾"
06-1314-03 15mm 21cm/8¼"
06-1314-04 20mm
06-1314-05 30 mm
06-1314-06 50mm
30 cm/12"

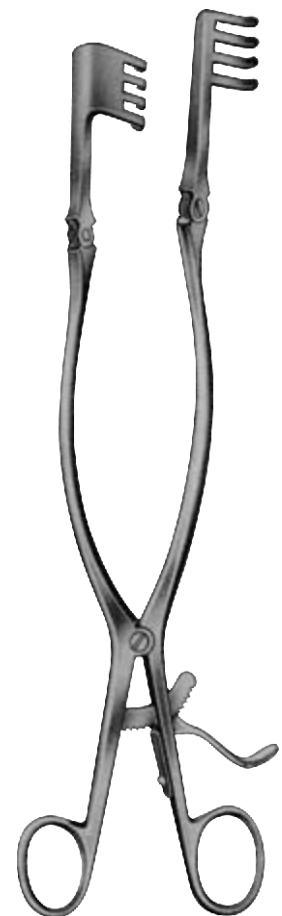

Sharp
scharf
net
agudo

BeckMann

blunt
stumpf
émousser
embotar

06-1315-31 31cm/12¼" 06-1315-31

General Instruments

Abdominal Retractors
Bauchdeckenhalter

Rétracteurs abdominale
Los retractoros abdominales

Hemilaminectomy Retractor
Hemilaminectomie Retraktor
enrouleur hémilaminectomie
hemilaminectomia retractor



06-1316-27
27cm/10½"



Beckmann-Eaton
06-1317-33
33 cm/13"

Retractors Only
Wundhaken Nur
Sólo Retractores...
Seulement Rétracteurs

Lateral Blades
seitlichen Flügel
lames latérales
cuchillas laterales

06-1318-01

06-1318-02

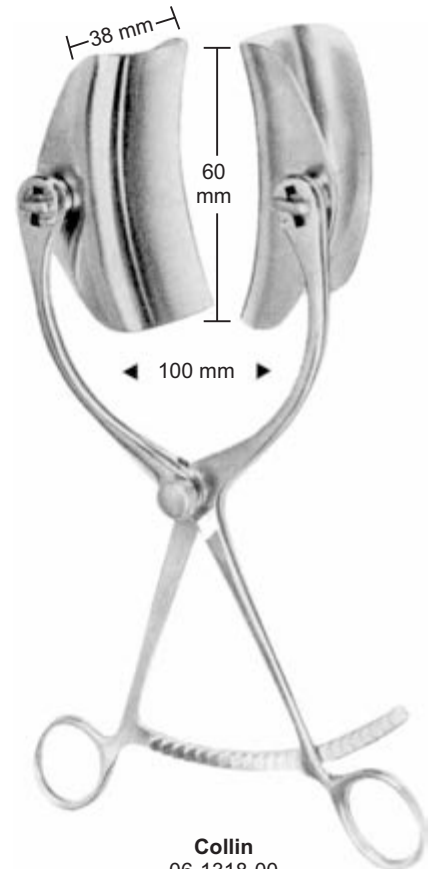

Collin
06-1318-00
22cm/8¾"

General Instruments

Abdominal Retractors
Bauchdeckenhalter

Rétracteurs abdominale
Los retractoros abdominales

06



Collin
22 cm/8³/₄"

Retractors Complete
Wundhaken Vollständige
Ecarteurs compleètes
Retractoros completos

Retractors Only
Wundhaken Nur
Sólo Retractoros...
Seulement Rétracteurs

Lateral Blades
seitlichen Flügel
lames latérales
cuchillas laterales

Central Blades
zentralen Klingen
lames centrales
paletas centrales

Fig. 1
06-1319-00

Fig. 2
06-1320-00

Fig. 3
06-1321-00

06-1319-01

06-1320-01

06-1321-01

06-1319-02
38x60 mm

06-1320-02
38x80 mm

06-1321-02
38x100 mm

06-1319-03
55x55 mm

06-1321-03
55x75 mm

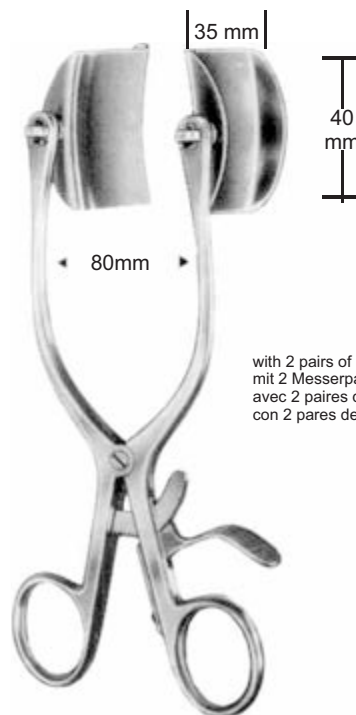

Baby-Collin
06-1322-00
18 cm/7"

with 2 pairs of blades
mit 2 Messerpaaren
avec 2 paires de lames
con 2 pares de cuchillas

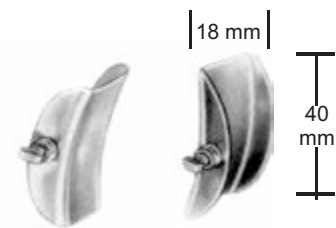

06-1322-01

General Instruments

Abdominal Retractors
Bauchdeckenhalter

Rétracteurs abdominale
Los retractoros abdominales

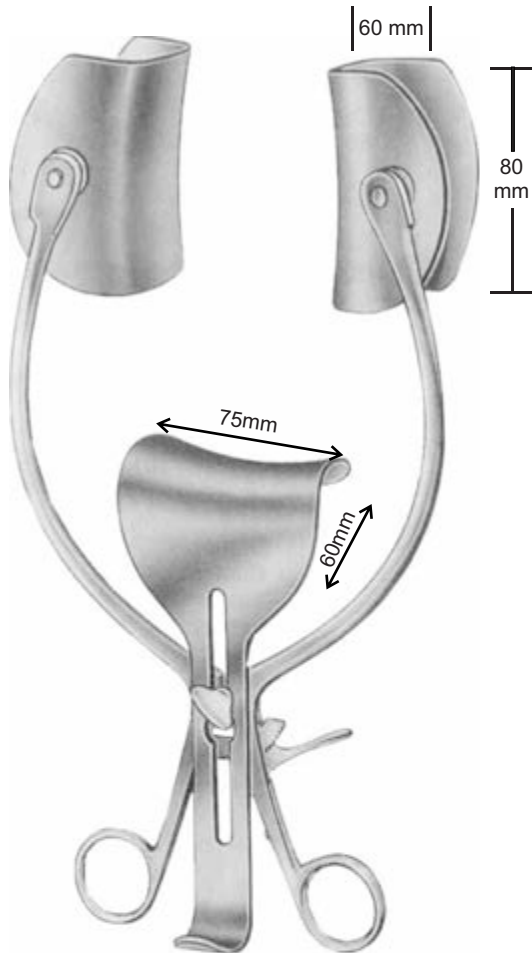

Collin

26 cm/10 1/2"

Retractors Complete
Wundhaken Vollständige
Ecarteurs complètes
Retractoros completos

06-1323-00
26cm/10 1/2"

Lateral Blades
seitlichen Flügel
lames latérales
cuchillas laterales

06-1323-01
60X80mm

Central Blades
zentralen Klingen
lames centrales
paletas centrales

06-1323-02
75X60mm

Retractors Only
Wundhaken Nur
Sólo Retractoros...
Seulement Rétracteurs

06-1323-03



Mayo-Adams

06-1324-17
17cm/6 3/4"

Mayo-Adams

06-1325-17
17cm/6 3/4"

General Instruments

Abdominal and Vulval Retractors
Bauch-und Vulva Retraktoren

Rétracteurs abdominaux et de la vulve
Los retractoros abdominales y la vulva



06

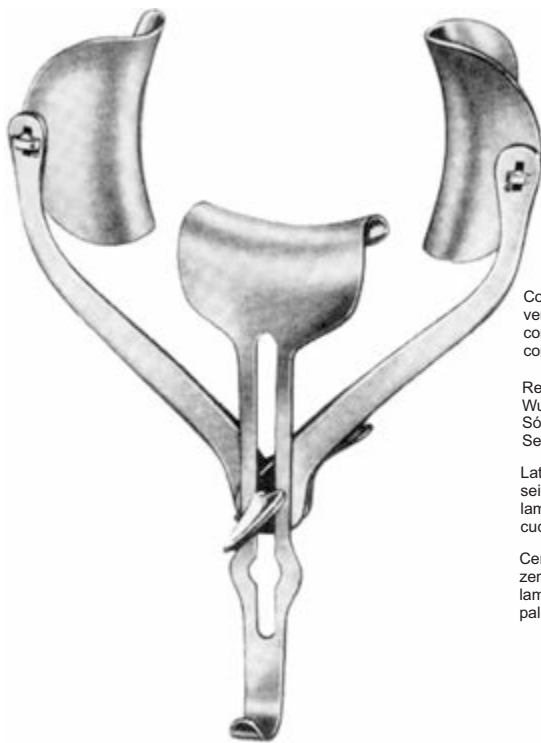

Complete
vervollständigen
completar

Fig. 1
06-1326-00

Fig. 2
06-1327-00

Retractors Only
Wundhaken Nur
Sólo Retractores...
Seulement Rétracteurs

06-1326-01

06-1327-01

Lateral Blades
seitlichen Flügel
lames latérales
cuchillas laterales

06-1326-02
60x80 mm

06-1327-02
75x85 mm

Central Blades
zentralen Klingen
lames centrales
paletas centrales

06-1326-03
55x70 mm

06-1327-03
80x90 mm

Ricard

06-1326-28 28cm/11"
06-1326-30 30cm/12"

Vulval Retractor
Vulva Retractor
Écarteur vulvaire
Retractor vulvar



Richter

06-1328-16
16.5 cm/6 1/2"



Gelpi

06-1330-09 9 cm/3 1/2"
06-1330-11 11 cm/4 1/2"
06-1330-13 13 cm/5"
06-1330-18 18 cm/7"



Gelpi

06-1331-18
18 cm/7"

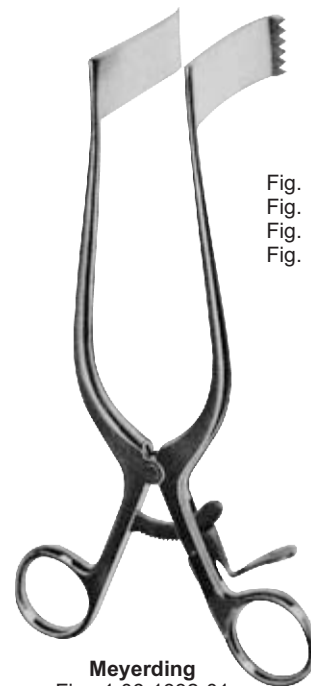

Meyerding

Fig. 1 06-1332-01
Fig. 2 06-1332-02
Fig. 3 06-1332-03
Fig. 4 06-1332-04
18 cm/7"

blades
Klingen
Lames
Hojas

Fig. 1 1 3/4"x1"
Fig. 2 2 1/8"x1"
Fig. 3 2 3/8"x1 3/4"
Fig. 4 2 3/8"x1"

General Instruments

Abdominal Retractors
Bauchdeckenhalter

Rétracteurs abdominale
Los retractoros abdominales



Markham-Meyering

06-1333-18 18cm/7" 06-1334-18



Rigby

06-1335-19
19cm/7½"



De Bakey

06-1336-12 12cm/4¾"
06-1336-17 17cm/6¾"



10cm/4"

40x30mm

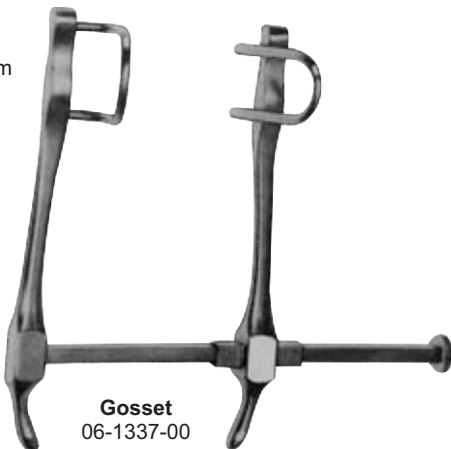

Gosset
06-1337-00

140mm

63x35mm



Gosset
06-1338-00

General Instruments

Abdominal Retractors
Bauchdeckenhalter

Rétracteurs abdominale
Los retractoros abdominales



06

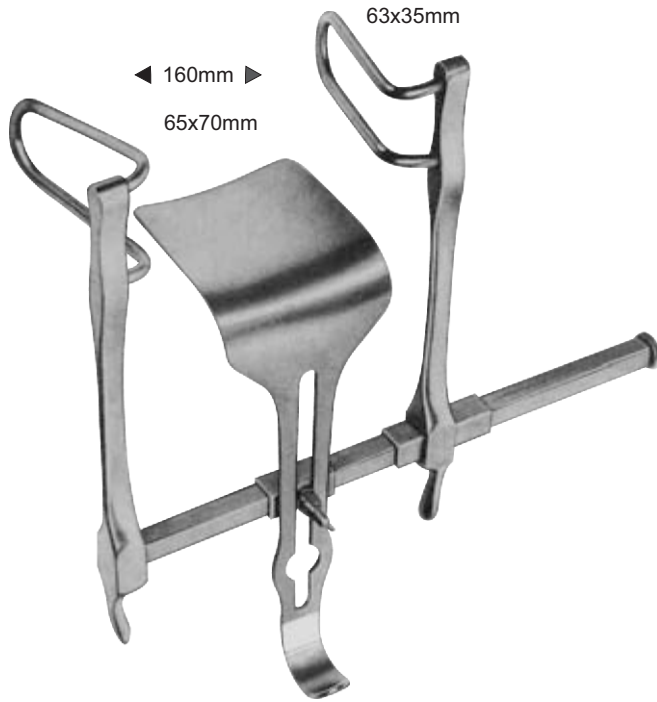

Gosset
06-1339-16

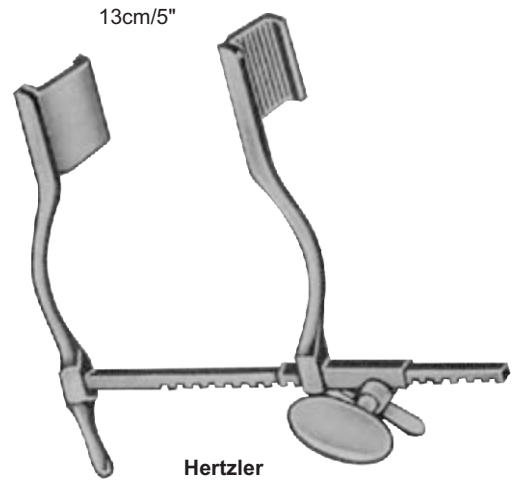

Hertzler
06-1340-00

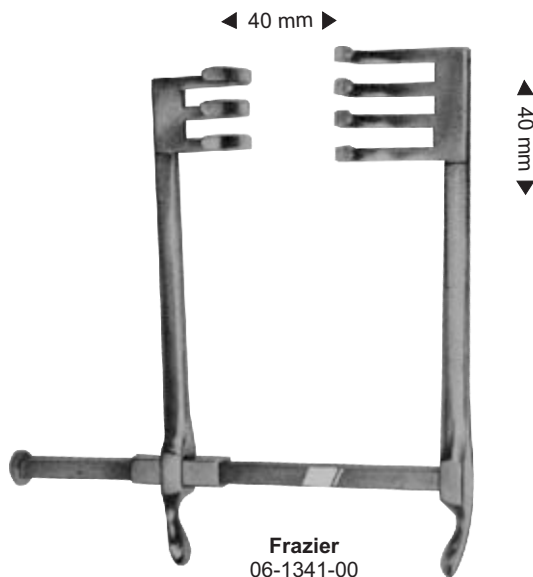

Frazier
06-1341-00

General Instruments

Retractors
Retraktoren

Rétracteurs
Retractoros

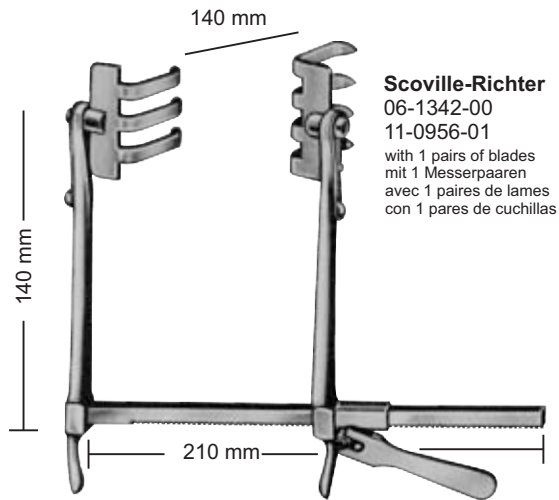

Scoville-Richter
06-1342-00
11-0956-01
with 1 pairs of blades
mit 1 Messerpaaren
avec 1 paires de lames
con 1 pares de cuchillas

the blades are available by pairs
die Schaufeln sind durch Paare
les lames sont disponibles par paires
Las cuchillas están disponibles por pares



06-1343-01
60x50 mm

06-1343-02
48x50 mm



06-1343-03
28x40 mm



06-1343-04
38x62 mm

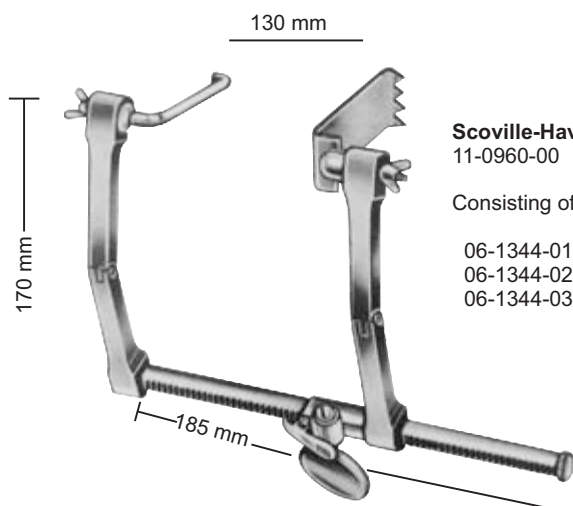

Scoville-Haverfield
11-0960-00
Consisting of:

06-1344-01
06-1344-02
06-1344-03



Scoville
06-1345-02
51 mm



Scoville
06-1345-03 63x25 mm
06-1345-04 63x51 mm
06-1345-05 67x32 mm
06-1345-06 89x25 mm



Taylor
06-1345-07
48x38 mm



Taylor
06-1345-08 63x51 mm
06-1345-09 79x57 mm

General Instruments

Abdominal Retractors
Bauchdeckenhalter

Rétracteurs abdominale
Los retractoros abdominales



06

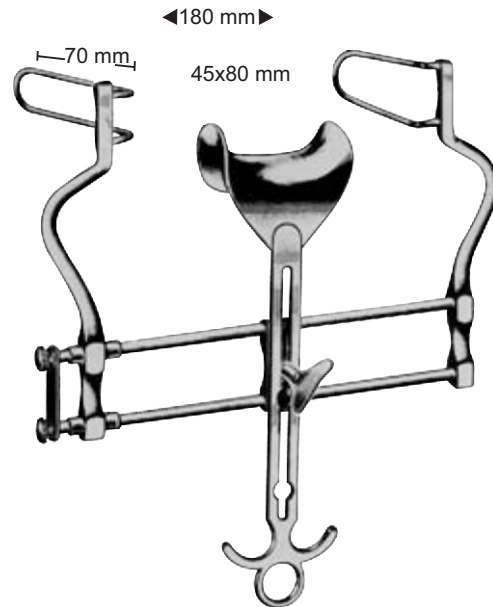
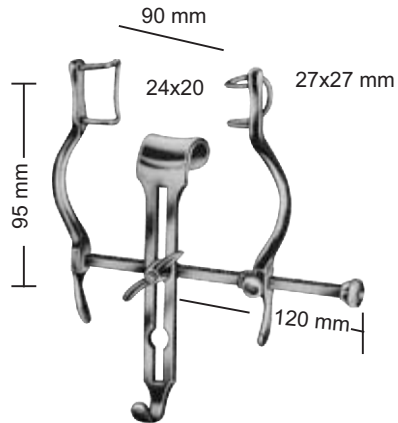

Retractors Complete
Wundhaken Vollständige
Ecarteurs complètes
Retractors completos

Baby-Balfour
06-1346-00

Balfour
06-1347-18

Retractors Only
Wundhaken Nur
Sólo Retractors...
Seulement Rétracteurs

06-1346-01

06-1347-01

Central Blades
zentralen Klängen
lames centrales
paletas centrales

06-1346-02
24x20mm

06-1347-02
45x80mm

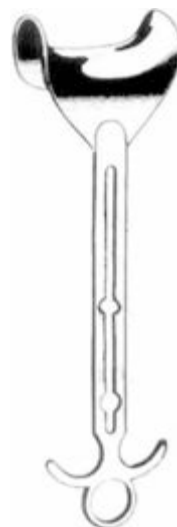

Balfour
06-1348-01 80x90mm

General Instruments

Abdominal Retractors
Bauchdeckenhalter

Rétracteurs abdominale
Los retractoros abdominales

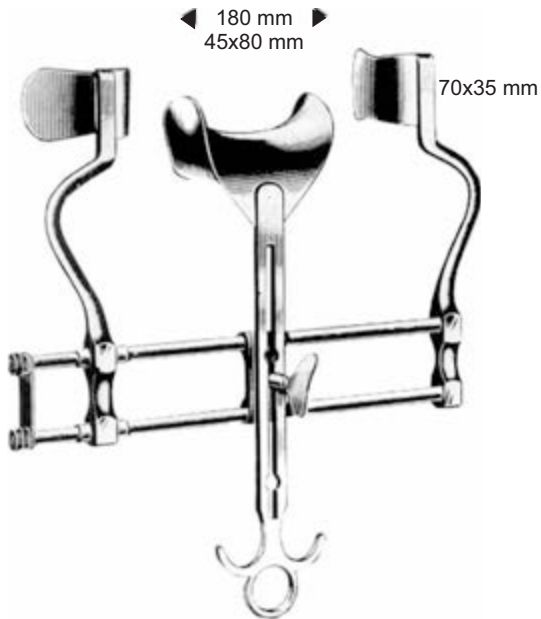

Balfour

Retractors Complete
Wundhaken Vollständige
Ecarteurs complètes
Retractoros completos

06-1349-18

Retractors Only
Wundhaken Nur
Sólo Retractoros...

Seulement Rétracteurs

06-1349-01

Central Blades
zentralen Klängen
lames centrales
paletas centrales

06-1349-02

45x80mm

Solid blade

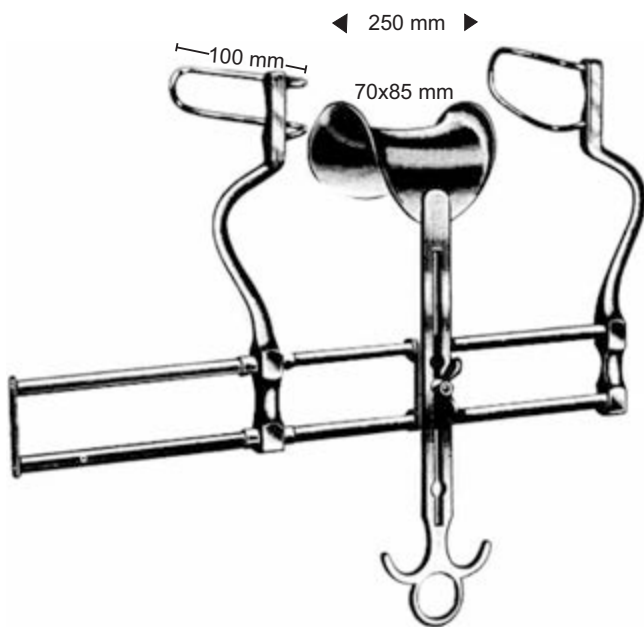

Balfour
06-1350-25

Retractors Complete
Wundhaken Vollständige
Ecarteurs complètes
Retractoros completos

06-1350-25

Retractors Only
Wundhaken Nur
Sólo Retractoros...

Seulement Rétracteurs

06-1350-01

Central Blades
zentralen Klängen
lames centrales
paletas centrales

06-1350-02

70x85mm

General Instruments

Abdominal Retractors
Bauchdeckenhalter

Rétracteurs abdominale
Los retractoros abdominales



06

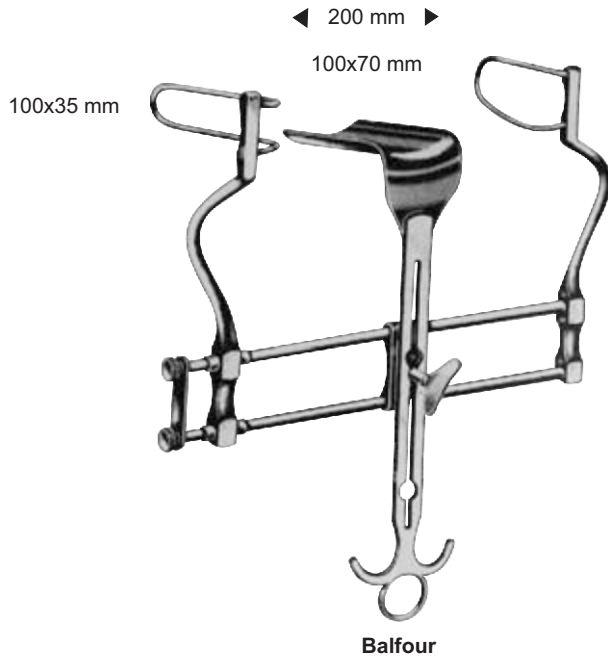

Retractors Complete
Wundhaken Vollständige
Ecarteurs complets
Retractoros completos
06-1351-20

Retractors Only
Wundhaken Nur
Sólo Retractoros...
Seulement Rétracteurs
06-1351-01

Central Blades
zentralen Klängen
lames centrales
paletas centrales
06-1351-02
100x70mm

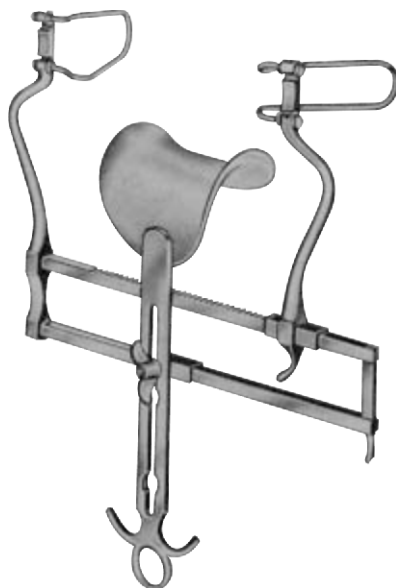

Balfour us-Type
06-1352-00
Complete



06-1353-01

Lateral blades, 6cm deep, per pair
seitliche Flügel, 6cm tief, pro Paar
lames latérales, 6cm de profondeur, par paire
cuchillas laterales, 6cm par profunda, por

06-1353-02

Lateral blades, 8cm deep, per pair
seitliche Flügel, 8cm tief, pro Paar
lames latérales, 8cm de profondeur, par paire
cuchillas laterales, 8cm par profunda, por

Central Blades only
zentralen Klängen Nur
lames centrales Sólo
Seulement paletas centrales

06-1353-03

40x68mm

06-1353-04

68x85mm

General Instruments

Abdominal Retractors
Bauchdeckenhalter

Rétracteurs abdominale
Los retractoros abdominales

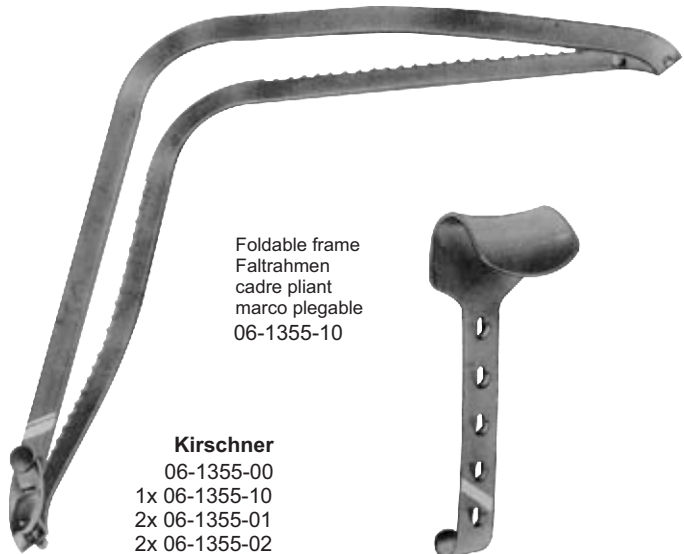
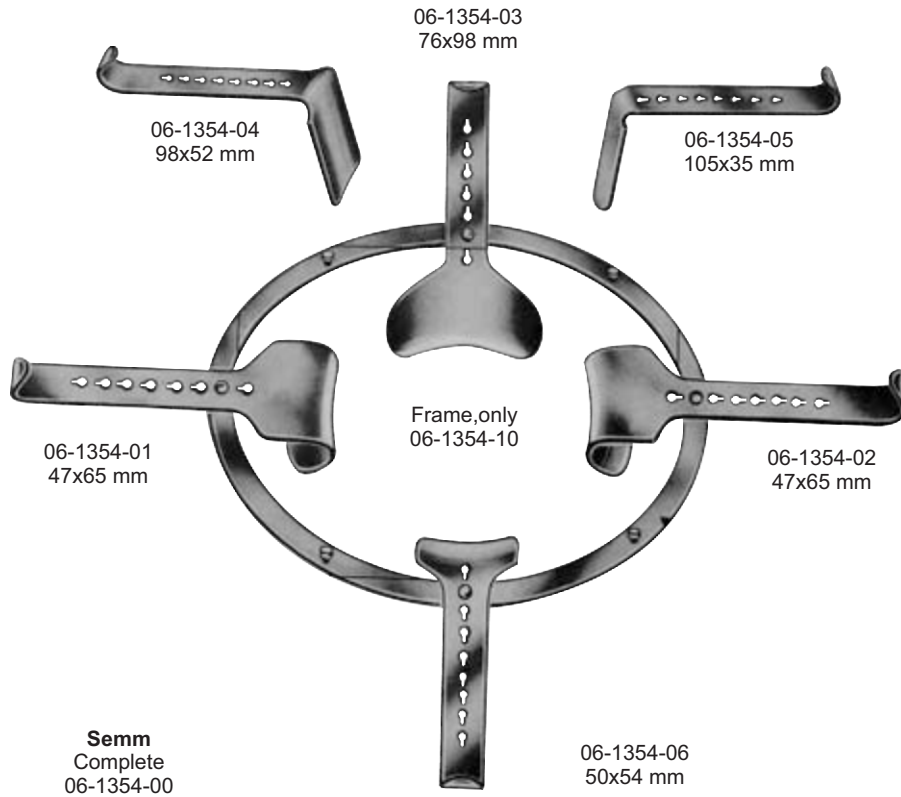

Complete
vervollständigen
compléter
completar

40x55 mm 06-1355-01
50x65 mm 06-1355-02
65x80 mm 06-1355-03
80x80 mm 06-1355-04
90x65 mm 06-1355-05
90x90 mm 06-1355-06



Complete
06-1356-00
1x 06-1356-10
2x 06-1356-01
2x 06-1356-02

General Instruments

Abdominal Retractors
Bauchdeckenhalter

Rétracteurs abdominale
Los retractoros abdominales



06

Frame

06-1357-10 178x140 mm
06-1358-20 255x178 mm

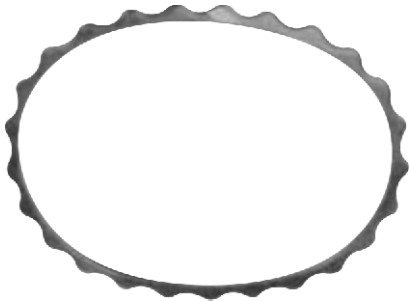

Complete
vervollständigen
compléter
completar
06-1357-00
06-1358-00

Denis-Brown
Consisting of
bestehend aus
composée d'
Compuesto por

1x 06-1359-10
1x 06-1360-20

Fig.1 06-1359-01 38x38 mm
Fig.2 06-1360-02 38x25 mm



2x 06-1359-01
2x 06-1360-01

2x 06-1359-02
2x 06-1360-02

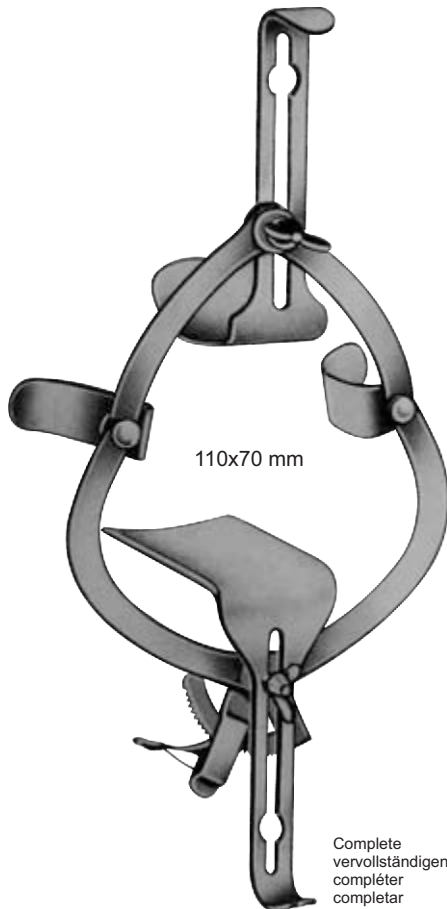

110x70 mm

Complete
vervollständigen
compléter
completar

O'Sullivan-O'Connor
06-1361-00

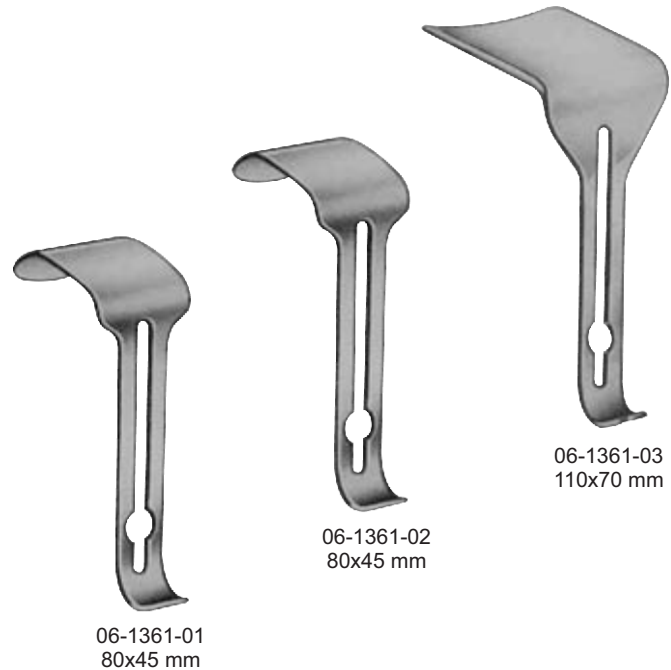

06-1361-01
80x45 mm

06-1361-02
80x45 mm

06-1361-03
110x70 mm

General Instruments

Abdominal Retractors
Bauchdeckenhalter

Rétracteurs abdominale
Los retractores abdominales



Doyen
06-1362-01 48x90mm
06-1362-02 48x105mm
06-1362-03 48x120mm
06-1362-04 48x135 mm



Rochard
06-1363-01 40x80mm
06-1363-02 50x100mm
06-1363-03 55x120mm



Doyen-Rochard
06-1364-01 45x80mm
06-1364-02 50x100mm
06-1364-03 65x120mm

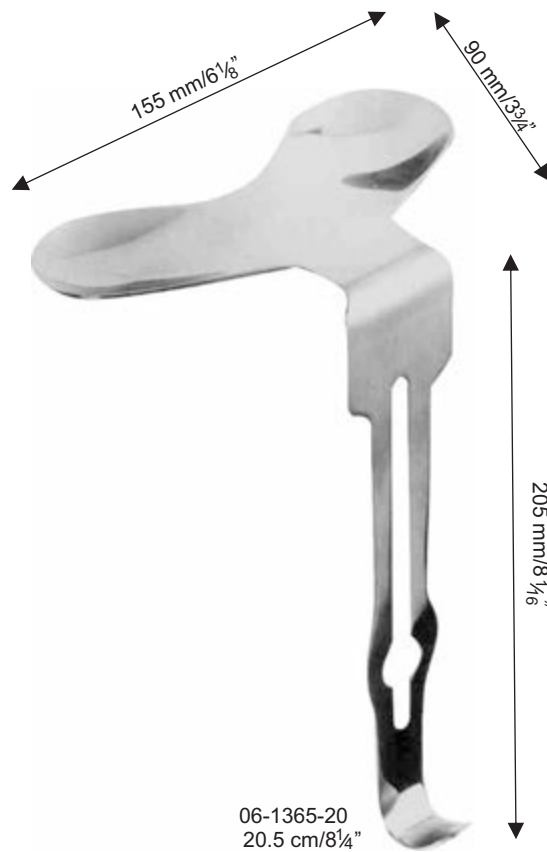

General Instruments

Abdominal Retractors
Bauchdeckenhalter

Rétracteurs abdominale
Los retractoros abdominales



06



06-1366-19
19 cm/7½"

06-1367-10
Foldable frame
Faltrahmen
cadre pliant
marco plegable

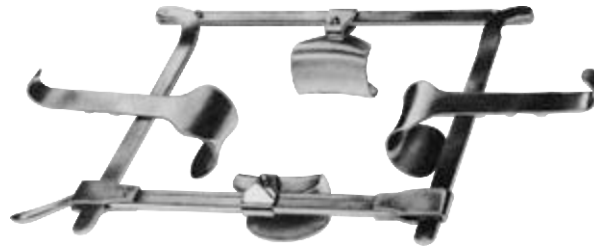

Franz

Complete with 4 valves
Komplett mit 4 Ventilen
Fourni avec 4 soupapes
Completa con 4 válvulas
06-1367-40

Complete with 8 valves
Komplett mit 8 Ventilen
Fourni avec 8 soupapes
Completa con 8 válvulas
06-1367-80

06-1367-03 50x65 mm
06-1367-04 60x85 mm

With
con
06-1367-10 1x
06-1367-01 2x
06-1367-03 2x

With
con
06-1367-10 1x
06-1367-01 2x
06-1367-02 2x
06-1367-03 2x
06-1367-04 2x

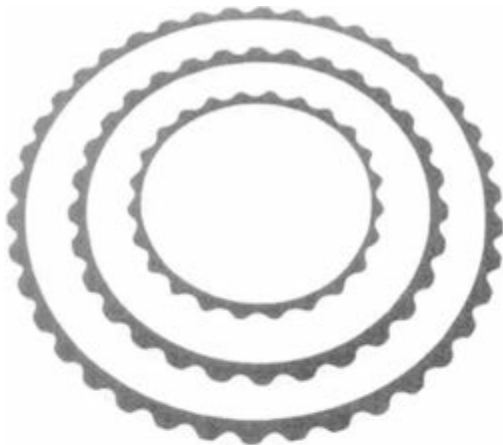

06-1368-00 Complete Set

Turner Warwick
1x 06-1368-18 18cm/7" Round
1x 06-1368-23 23cm/9" Round
1x 06-1368-30 30cm/12" Round
1x 06-1368-45 45cm/18" Oval
33cm/13"

Copper Blade



06-1368-01
19 x 76 mm

368-02
89 mm

368-03
m

2x 06-1368-04
57 x 114 mm



2x 06-1368-05
76 x 60 mm

2x 06-1368-06
51 x 38 mm



2x 06-1368-07
89 x 60 mm

2x 06-1368-08
114 x 60 mm

General Instruments

 Probes sonden
 sondes sondas

cm	In	1.0 mmØ	1.5 mmØ	2.0 mmØ	2.0 mmØ		Watson-Cheyne	Fish
11.5	4 1/2"	07-1370-11	07-1371-11	07-1372-11		07-1374-11		
13	5"	07-1370-13	07-1371-13	07-1372-13		07-1374-13	07-1375-13	
14	5 1/2"	07-1370-14	07-1371-14	07-1372-14	07-1373-14	07-1374-14		07-1376-14
16	6 1/4"	07-1370-16	07-1371-16	07-1372-16	07-1373-16	07-1374-16		
18	7"	07-1370-18	07-1371-18	07-1372-18		07-1374-18	07-1375-18	07-1376-18
20	8"	07-1370-20	07-1371-20	07-1372-20		07-1374-20		
25	10"	07-1370-25	07-1371-25	07-1372-25				



cm	In						Stacke 1.0 mm Ø	Brodie
10.5	4 1/4"						07-1383-10	
11.5	4 1/2"	07-1378-11						
13	5"	07-1378-13		07-1380-13	07-1381-13			
14	5 1/2"	07-1378-14	07-1379-14	07-1380-14	07-1381-14			
16	6 1/4"	07-1378-16		07-1380-16	07-1381-16	07-1382-16		07-1384-16
18	7"	07-1378-18		07-1380-18				
20	8"	07-1378-20			07-1381-20			

General Instruments

Probes, Plaster Spatulas, Cotton Applicators and Fistula Probes
 Probes, Gips Spatel, Watteträger und Fistula Probes

Sondas, espátulas de yeso, aplicadores de algodón y sondas fistula



07

Of tin
 Zinn
 de l'étain
 De estaño



07-1385-25 25 cm/10"
 07-1385-30 30 cm/12"
 07-1385-40 40 cm/15¾"

Plaster spatulas
 Gips Spatel
 spatules en plâtre
 espátulas de yeso



07-1386-13 13 cm/5"
 07-1386-14 14 cm/5½"

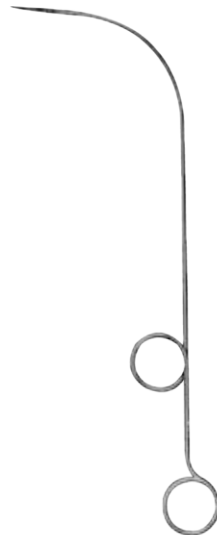

Pelteson
 07-1387-23
 23 cm/9"

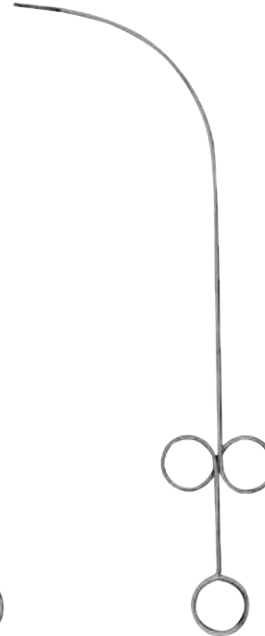

Fein
 07-1388-28
 28 cm/11"



Buie
 07-1389-16
 16 cm/6¼"

Fistula probes
 Fistula Sonden
 sondes fistule
 sondas Fistula



Lockhart-Mummary
 16.5 cm/6½"



Fig. 1
 07-1390-01



Fig. 2
 07-1390-02



Fig. 3
 07-1390-03



Fig. 4
 07-1390-04

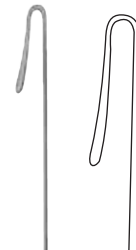

07-1391-01



07-1391-02



07-1391-03

Pratt
 21 cm/8¼"

General Instruments

Cotton Applicators
Watteträger

Les applicateurs de coton
Los aplicadores de algodón



Universal

cm	in	1.2 mm Ø	1.5 mm Ø	1.7 mm Ø
12.5	5"	07-1392-12		
16	6¼"	07-1392-16		
18	7"	07-1392-18	07-1393-18	07-1394-18



Uckermann
07-1395-16
16 cm/6¼"



Jobson-Horne
07-1396-13 13 cm/5"
07-1396-18 18 cm/7"



Round
runden
autour
redondear

Triangular
dreieckig
triangulaire
triangular

**Farrell
(Farrell-Lathbury)**

cm	in	0.9 mm Ø	1.1 mm Ø	1.2 mm Ø	1.5 mm Ø	1.7 mm Ø
12	4¾"			●	▲	
14	5½"	07-1397-14	07-1398-14			
16	6¼"	07-1397-16	07-1398-16			
18	7"					



Round
runden
autour
redondear

Triangular
dreieckig
triangulaire
triangular

1.2 mm Ø	1.5 mm Ø	1.7 mm Ø
●	●	▲
07-1399-12	07-1400-12	07-1401-12
07-1399-14	07-1400-14	07-1401-14
07-1399-16	07-1400-16	07-1401-16
07-1399-18	07-1400-18	07-1401-18

General Instruments

Cotton Applicators
Watteträger

Les applicateurs de coton
Los aplicadores de algodón



07



07-1402-01



07-1402-02



07-1402-03



07-1403-28
07-1403-38



07-1404-28
07-1404-38



Frankfeldt
07-1405-36
36cm/14 1/4"

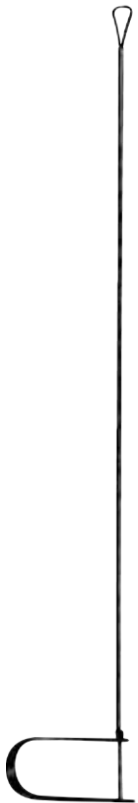

28cm/11"
38cm/15"



28cm/11"
2.5 mm Ø

General Instruments

Varicose Vein Probe Set and Vein Strippers
 Krampfadem Probe Set und Venenstripper

Varices Probe Set veine et décapants Vein
 Várices Juego de sondas y de las venas Strippers

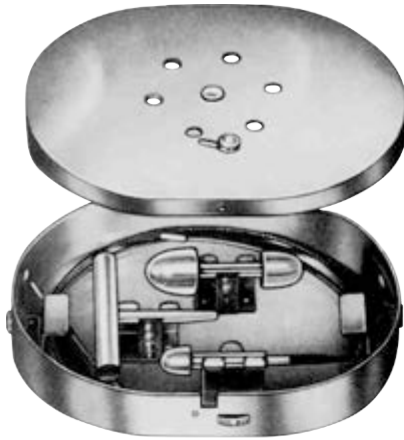

Nabatoff
 07-1406-00
 135x100x25 mm

Sterilizable
 sterilisierbar
 stérilisable
 Esterilizable

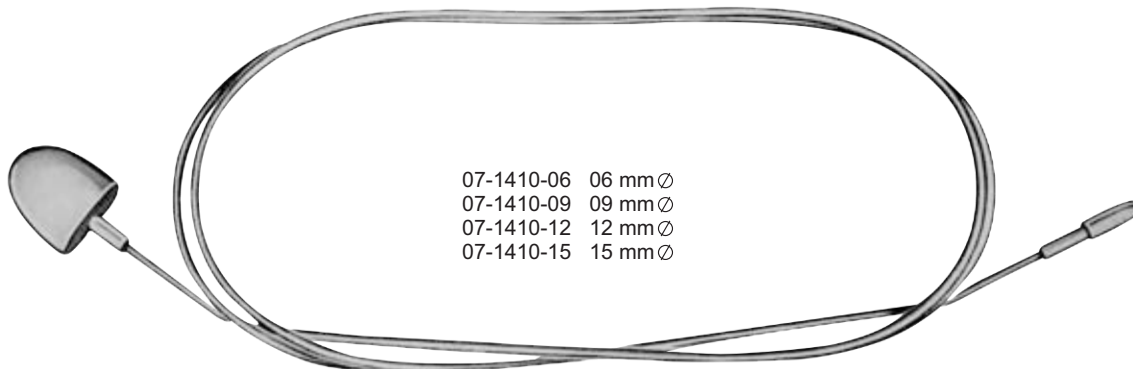
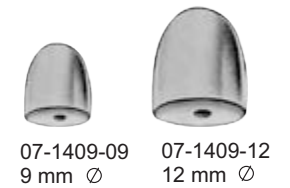
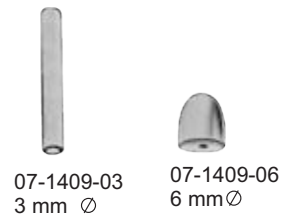
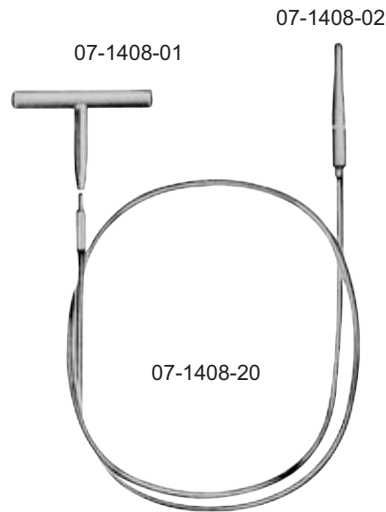

Myers

General Instruments

Endarterectomy
Endarteriektomie

L'endartériectomie
La endarterectomia



07



Strippers
Stripperinnen
décapants
strippers

	mm Ø
07-1411-02	2.0
07-1411-03	3.0
07-1411-04	4.0
07-1411-06	6.0
07-1411-07	7.0
07-1411-08	8.5
07-1411-10	10.0
07-1411-12	12.0
07-1411-14	14.0



Handle for
07-1411-00

Vollmar
55cm/21½"



Probes for Varicose Veins

Malleable
formbar
malléable
maleable

cm	in	
40	13½"	07-1412-40
50	20"	07-1412-50
65	26"	07-1412-65
80	32"	07-1412-80

Babcock



Schimd

Vessel Irrigating Cannulas



07-1413-03
3 mm Ø



07-1413-04
4 mm Ø



07-1413-05
5mmØ



07-1413-06
6mmØ



3 mm
Blunt

07-1414-18 18.0 cm/7"
07-1414-21 21.5 cm/8½"

Spatulas



Schmid



07-1415-14
14 cm/5½"
5 mm



07-1415-24
24 cm/9½"
7 mm

Suture Instruments

Micro Needle Holders
Mikronadelhalter

Porte-aiguilles Micro
Los titulares de aguja Micro



Castroviejo
14cm/5½"



Straight
gerade
droit
recto

08-1416-14



Curved
Gebogene
courbé
Curvo

08-1417-14



Castroviejo



Straight
gerade
droit
recto

08-1418-14
08-1418-18



Curved
Gebogene
courbé
Curvo

08-1419-14
08-1419-18



Castroviejo
9cm/3½"



Straight
gerade
droit
recto

08-1420-09



Curved
Gebogene
courbé
Curvo

08-1421-09



Castroviejo
14cm/5½"



Straight
gerade
droit
recto

08-1422-14



Curved
Gebogene
courbé
Curvo

08-1423-14

Suture Instruments

Micro Needle Holders
Mikronadelhalter

Porte-aiguilles Micro
Los titulares de aguja Micro



08



Castroviejo
9 cm/3 1/2"

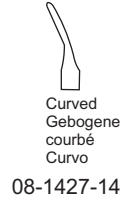
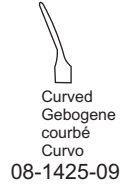

Castroviejo
14 cm/5 1/2"



Paton
08-1428-11
11.5 cm/4 1/2"



Jacobson

cm	in	Without Ratchet	With Ratchet
		ohne Ratchet sans cliquet Sin Ratchet	mit Ratchet avec Ratchet Con Ratchet
18	7"	08-1429-18	08-1430-18
21	8 1/4"	08-1429-21	08-1430-21

Suture Instruments

Micro Needle Holders
Mikronadelhalter

Porte-aiguilles Micro
Los titulares de aguja Micro



Yasargil



Straight
gerade
droit
recto

08-1431-20 20.0 cm/8"
08-1431-22 22.5 cm/9"



Curved
Gebogene
courbé
Curvo

08-1432-16 16.5 cm/6½"
08-1432-20 20.0 cm/9"
08-1432-22 22.5 cm/9"
08-1432-24 24.5 cm/9¾"



Straight
gerade
droit
recto

08-1433-16 16.0 cm/6¼"
08-1433-18 18.5 cm/7¼"



Curved
Gebogene
courbé
Curvo

08-1434-16 16.0 cm/6¼"
08-1434-18 18.5 cm/7¼"

Suture Instruments

Micro Needle Holders
Mikronadelhalter

Porte-aiguilles Micro
Los titulares de aguja Micro



08



08-1435-15
15 cm/6"
Straight
gerade
droit
recto



08-1436-15
15 cm/6"
Curved
Gebogene
courbé
Curvo



08-1437-18
18 cm/7"
Straight
gerade
droit
recto



08-1438-18
18 cm/7"
Curved
Gebogene
courbé
Curvo



08-1439-18
18 cm/7"
Straight
gerade
droit
recto

Suture Instruments

Micro Needle Holders
Mikronadelhalter

Porte-aiguilles Micro
Los titulares de aguja Micro

Straight
gerade
droit
recto



08-1440-18
08-1440-22

Curved
Gebogene
courbé
Curvo



08-1441-18
08-1441-22

Yasargil
18.0 cm/7"
22.5 cm/8¾"

Suture Instruments

Micro Needle Holders
Mikronadelhalter

Porte-aiguilles Micro
Los titulares de aguja Micro

08



08-1442-15
15 cm/6"
Straight
gerade
droit
recto



08-1443-15
15 cm/6"
Curved
Gebogene
courbé
Curvo



08-1444-15
15 cm/6"
Straight
gerade
droit
recto



08-1445-15
15 cm/6"
Curved
Gebogene
courbé
Curvo

Suture Instruments

Micro Needle Holders
Mikronadelhalter

Porte-aiguilles Micro
Los titulares de aguja Micro



08-1446-18
18.5 cm/7¼"
Straight
gerade
droit
recto



08-1447-18
18.5 cm/7¼"
Curved
Gebogene
courbé
Curvo



08-1448-18
18.5 cm/7¼"
Straight
gerade
droit
recto



08-1449-18
18.5 cm/7¼"
Curved
Gebogene
courbé
Curvo

Straight
gerade
droit
recto
08-1450-01
23 cm/9"



Curved
Gebogene
courbé
Curvo
08-1450-02
23 cm/9"

23 cm/9"

Suture Instruments

Micro Needle Holders
Mikronadelhalter

Porte-aiguilles Micro
Los titulares de aguja Micro



08



Straight
gerade
droit
recto



Curved
Gebogene
courbé
Curvo

08-1451-18 18 cm/7"
08-1451-21 21 cm/8¼"
08-1451-23 23 cm/9¼"

With Ratchet
mit Ratchet
avec Ratchet
Con Ratchet

08-1452-18 18 cm/7"
08-1452-21 21 cm/8¼"
08-1452-23 23 cm/9¼"

Without Ratchet
ohne Ratchet
sans cliquet
Sin Ratchet

Suture Instruments

Micro Needle Holders
Mikronadelhalter

Porte-aiguilles Micro
Los titulares de aguja Micro



08-1453 -12
12 cm/4¾"
Straight
gerade
droit
recto

08-1454 -12
12 cm/4¾"
Curved
Gebogene
courbé
Curvo

08-1455 -12
12 cm/4¾"
Angled
Anglé
incliné
angular

08-1456 -12
12 cm/4¾"
Straight
gerade
droit
recto

08-1457 -12
12 cm/4¾"
Curved
Gebogene
courbé
Curvo

08-1458 -12
12 cm/4¾"
Angled
Anglé
incliné
angular

Suture Instruments

Micro Needle Holders
Mikronadelhalter

Porte-aiguilles Micro
Los titulares de aguja Micro



08



Arruga
14 cm/5½"



Straight
gerade
droit
recto
08-1459 -14



Curved
Gebogene
courbé
Curvo
08-1460 -14



Stevens
08-1461 -13 13 cm/5"
08-1461 -15 15 cm/6"



Kalt
08-1462 -14
14 cm/5½"



Castroviejo-Kalt
08-1463 -13
13.5 cm/5¼"



Kalt-Arruga
08-1464 -14
14 cm/5½"

Suture Instruments

Micro Needle Holders
Mikronadelhalter

Porte-aiguilles Micro
Los titulares de aguja Micro





 Straight
gerade
droit
recto
08-1465 -12

 Curved
Gebogene
courbé
Curvo
08-1466 -12



 Straight
gerade
droit
recto
08-1467 -12

 Curved
Gebogene
courbé
Curvo
08-1468 -12

Castroviejo
12cm/4³/₄"

Castroviejo
12cm/4³/₄"



Castroviejo
08-1469 -13
13cm/5"



Boynton
08-1470 -12
12cm/4³/₄"

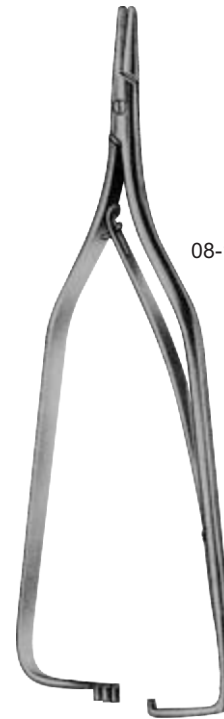

Arruga
16cm/6¹/₄"

 Straight
gerade
droit
recto
08-1471 -16

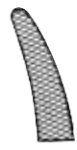
 Curved
Gebogene
courbé
Curvo
08-1472 -16

Suture Instruments

Micro Needle Holders with Tungsten Carbide Inserts Porte-aiguilles Micro avec inserts en carbure de tungstène
 Micro Nadelhalter mit Metall-Wendeplatten Titulares Micro agujas de tungsteno con Piezas de metal duro



08

Smooth
glätten
lisser
suavizar



14cm/5½"
18cm/7"
21cm/8¼"



08-1473 -14
08-1473 -18
08-1473 -21



08-1475 -14
08-1475 -18
08-1475 -21



14cm/5½"
18cm/7"
21cm/8¼"

08-1474 -14
08-1474 -18
08-1474 -21



08-1476 -14
08-1476 -18
08-1476 -21



08-1477 -14



08-1478 -14



Kalt
14cm/5½"

**Micro Nadelhalter mit
Castroviejo**



Barraquer
08-1480 -14
14cm/5½"



Castroviejo
08-1481 -13
13cm/5"



Hepp-Schiedel
18cm/7"



08-1482 -18



08-1483 -18

Smooth
glätten
lisser
suavizar

Suture Instruments

Micro Needle Holders with Tungsten Carbide Inserts
 Micro Nadelhalter mit Hartmetall-Wendeplatten

Porte-aiguilles Micro avec inserts en carbure de tungstène
 Titulares Micro agujas de tungsteno con Piezas de metal duro



Arruga
 14cm/5½"

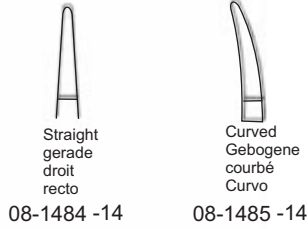

Jacobson
 08-1487 -18 18cm/7"
 08-1487 -20 20cm/8"
 08-1487 -23 23cm/8¾"



Diethrich

Straight gerade droit recto	Curved Gebogene courbé Curvo
08-1488 -16	16cm/6¼" 08-1489 -16
08-1488 -18	18cm/7" 08-1489 -18
08-1488 -20	20cm/8" 08-1489 -20
08-1488 -23	23cm/9" 08-1489 -23
08-1488 -25	25cm/10" 08-1489 -25

Suture Instruments

Micro Needle Holders
Mikronadelhalter

Porte-aiguilles Micro
Los titulares de aguja Micro



08



08-1490 -13



08-1491 -13
Smooth
glätten
lisser
suavizar



Halsey
13cm/5"



08-1492 -13
Smooth
glätten
lisser
suavizar



Webster
13cm/5"



Derf
08-1493 -12
12cm/4¾"



Derf
08-1494 -12
12.5cm/5"



Collier
08-1495 -12
12.5cm/5"



Hegar-Baumgartner
08-1496 -14
14cm/5½"



Brown
08-1497 -13 13cm/5"
08-1497 -18 18cm/7"



New Orleans
08-1498 -18
18cm/7"



Suture Instruments

Micro Needle Holders
Mikronadelhalter

Porte-aiguilles Micro
Los titulares de aguja Micro



Mayo-Hegar

13cm/5"	08-1499 -13
14cm/5½"	08-1499 -14
16cm/6¼"	08-1499 -16
18cm/7"	08-1499 -18
20cm/8"	08-1499 -20
24cm/9½"	08-1499 -24
26cm/10¼"	08-1499 -26
30cm/12"	08-1499 -30



08-1500 -16
08-1500 -18
08-1500 -20
08-1500 -24
08-1500 -26
08-1500 -30



Heaney
08-1501 -21
21cm/8¼"

Delicate Pattern
zarte Muster
modèle délicat
patrón delicado



Mayo-Hegar
08-1502 -16 16cm/6 ¼"
08-1502 -18 18cm/7"
08-1502 -20 20cm/8"



Heavy Pattern
schwere Pattern
modèle lourd
patrón pesado



Hegar
08-1503 -16 16cm/6¼"
08-1503 -18 18cm/7"
08-1503 -20 20cm/8"



Suture Instruments

Micro Needle Holders
Mikronadelhalter

Porte-aiguilles Micro
Los titulares de aguja Micro



08

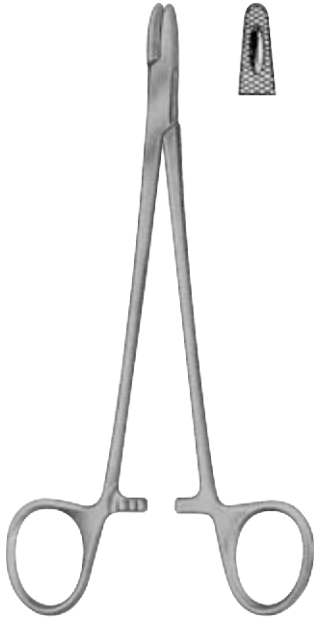

M.G.H.
(Mass.-General-Hospital)
08-1504 -17
16 cm/6 "



Sarot
08-1505 -18 18.5 cm/7 "
08-1505 -26 26.0 cm10 "



Finocchietto
08-1506 -27
27 cm/10 "



Masson
08-1507 -27
27 cm/10½"



Jameson
08-1508 -23
23.5 cm/9¼"

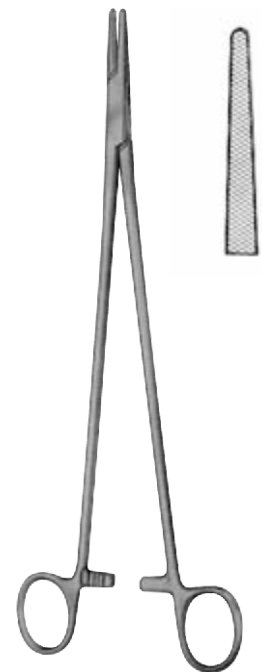

Wangenstein
08-1509 -27
27 cm/10½"

Suture Instruments

Micro Needle Holders
Mikronadelhalter

Porte-aiguilles Micro
Los titulares de aguja Micro



Crile-Wood
08-1510 -01
15 cm/6"



Crile-Murray
08-1510-02
15 cm/6"



Adson
08-1511 -18
18 cm/7"



Ermold
08-1512 -17 17 cm/6¾"
08-1512 -20 20 cm/8"



Baby-Olsen-Hegar
11.5 cm/4½"



08-1513 -11
Smooth
glätten
lisser
suavizar



Olsen-Hegar
08-1514 -14 14 cm/5½"
08-1514 -18 18 cm/7"



Olsen-Hegar
08-1515 -17
17 cm/6¾"



Suture Instruments

Micro Needle Holders
Mikronadelhalter

Porte-aiguilles Micro
Los titulares de aguja Micro



08



Olsen-Hegar
08-1516 -14
14 cm/5½"



Gillies
08-1517 -16 L
08-1517 -16 R
16 cm/6¼"



Gillies Slim
08-1518 -14
14 cm/5½"



Crile
08-1519 -15
15 cm/6"

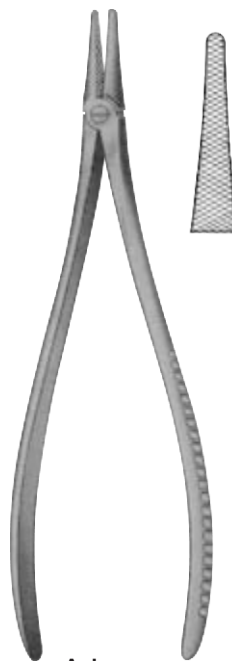

Axhausen
08-1520 -18
18.5 cm/7¼"



Lichtenberg
08-1521 -20
20 cm/8"

Suture Instruments

Micro Needle Holders
Mikronadelhalter

Porte-aiguilles Micro
Los titulares de aguja Micro



Toennis
08-1522 -18
18 cm/7"



Mathieu

08-1523 -14	14 cm/5 1/2"	08-1524 -14
08-1523 -17	17 cm/6 3/4"	08-1524 -17
08-1523 -20	20 cm/8"	08-1524 -20



Mathieu

08-1525 -14	14 cm/5 1/2"
08-1525 -17	17 cm/6 3/4"
08-1525 -20	20 cm/8"

Suture Instruments

Micro Needle Holders with Tungsten Carbide Inserts
 Micro Nadelhalter mit Hartmetall-Wendeplatten

Porte-aiguilles Micro avec inserts en carbure de tungstène
 Titulares Micro agujas de tungsteno con Piezas de metal duro

08



Crile-Wood

	cm	in
08-1526 -18	18	7"
08-1526 -20	20	8"
08-1526 -23	23	9"
08-1526 -26	26	10¼"
08-1526 -31	31	12¼"

08-1527 -15



Crile-Wood
15cm/6"

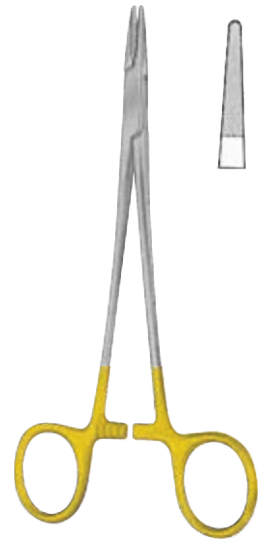

Baby-Crile-Wood
08-1528 -15
15cm/6"

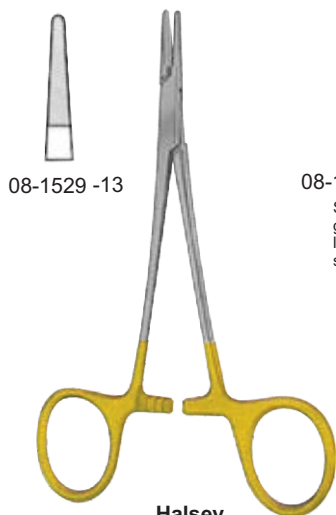

08-1529 -13

Halsey
13cm/5"



08-1530 -13
Smooth
glätten
lisser
suavizar



Converse
08-1531 -12
12.5cm/5"



Kilner
08-1532 -13
13.5cm/5¼"

Suture Instruments

Micro Needle Holders with Tungsten Carbide Inserts
 Micro Nadelhalter mit Hartmetall-Wendeplatten

Porte-aiguilles Micro inserts en carbure de tungstène
 Titulares Micro agujas de tungsteno con Piezas de metal duro

08



Mayo-Hegar



08-1533-16
 08-1533-18
 08-1533-20
 08-1533-24
 08-1533-26
 08-1533-30



08-1534-20
 08-1534-24
 08-1534-26

16cm/6¼"
 18cm/7"
 20cm/8"
 24cm/9½"
 26cm/10½"
 30cm/12"



Hegar-Baumgartner
 08-1535-14
 14cm/5½"

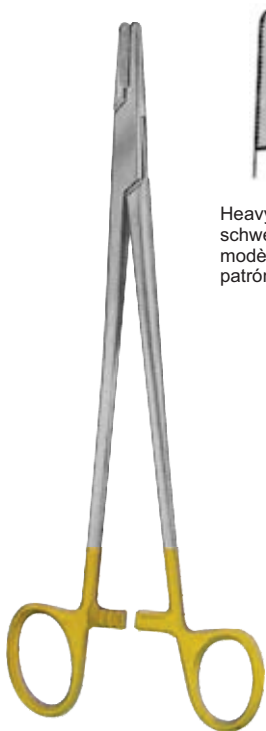

Heavy Pattern
 schwere Pattern
 modèle lourd
 patrón pesado

Mayo-Hegar
 08-1536-20 20cm/8"
 08-1536-24 24cm/9½"



De Bakley
 08-1537-18 18cm/7"
 08-1537-20 20cm/8"
 08-1537-23 23cm/9"
 08-1537-26 26cm/10¼"
 08-1537-31 31cm/12¼"



De Bakley-Fine
 08-1538-18
 08-1538-20
 08-1538-23
 08-1538-26
 08-1538-31

Suture Instruments

Micro Needle Holders with Tungsten Carbide Inserts
 Micro Nadelhalter mit Hartmetall-Wendeplatten

Porte-aiguilles Micro avec inserts en carbure de tungstène
 Titulares Micro agujas de tungsteno con Piezas de metal duro



08

Two rings angled
 Zwei Ringe abgewinkelt
 Deux anneaux angle
 Dos anillos de ángulo

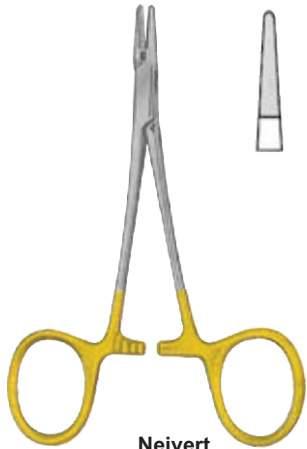

Neivert
 08-1539-13
 13 cm/5"



Neivert
 08-1540-13
 13 cm/5"



Webster
 08-1541-13
 13 cm/5"



Derf
 08-1542-12
 12.5 cm/5"



Derf
 08-1543-12
 12.5cm/5"



New Orleans
 08-1544-18
 18 cm/7"



Bozemann
 08-1545-20 20 cm/8"
 08-1545-24 24 cm/9½"
 08-1545-26 26 cm/10½"

Suture Instruments

Micro Needle Holders with Tungsten Carbide Inserts
 Micro Nadelhalter mit Hartmetall-Wendeplatten

Porte-aiguilles Micro avec inserts en carbure de tungstène
 Titulares Micro agujas de tungsteno con Piezas de metal duro

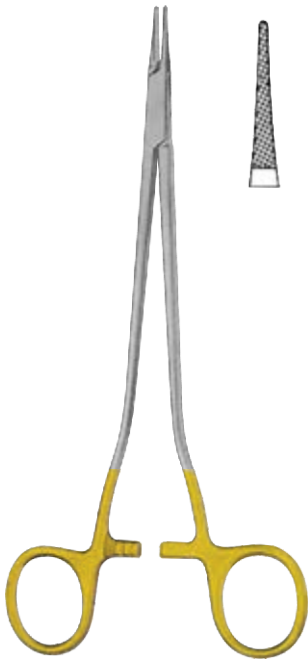

Hegar-Vascular
 08-1546-14 14cm/5½"
 08-1546-18 18cm/7"
 08-1546-20 20cm/8"
 08-1546-23 23cm/9"



Ryder
 08-1547-13
 08-1547-15
 08-1547-18
 08-1547-20
 08-1547-23
 08-1547-26



Micro-Ryder
 08-1548-13 13cm/5"
 08-1548-15 15cm/6"
 08-1548-18 18cm/7"
 08-1548-20 20cm/8"
 08-1548-23 23cm/9"
 08-1548-26 26cm/10¼"



(Swedish Pattern)
 08-1549-15 15cm/6"
 08-1549-17 17cm/6¾"
 08-1549-20 20cm/8"



Sarot
 08-1550-18 18cm/7"
 08-1550-26 26cm/10¼"

Suture Instruments

Micro Needle Holders with Tungsten Carbide Inserts
Micro Nadelhalter mit Hartmetall-Wendeplatten

Porte-aiguilles Micro avec inserts en carbure de tungstène
Titulares Micro agujas de tungsteno con Piezas de metal duro



08

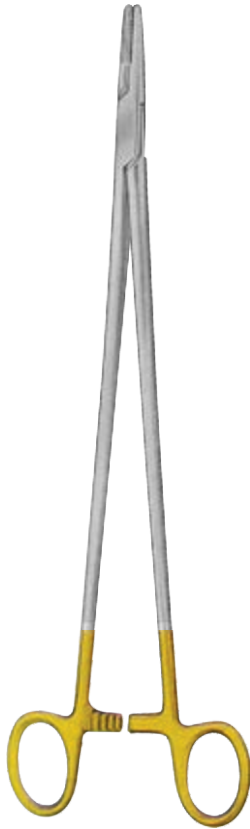

Masson
08-1551-27
27cm/10½"



Wangensteen
08-1552-27
27cm/10½"



Finocchietto
08-1553-20 20cm/8"
08-1553-27 27cm/10½"



Stratte
08-1554-23
23cm/9"

Suture Instruments

Micro Needle Holders with Tungsten Carbide Inserts
 Micro Nadelhalter mit Hartmetall-Wendeplatten

Porte-aiguilles Micro inserts en carbure de tungstène
 Titulares Micro agujas de tungsteno con Piezas de metal duro



Mathieu

14cm/5 $\frac{1}{2}$ "	08-1555-14
17cm/6 $\frac{3}{4}$ "	08-1555-17
20cm8"	08-1555-20
24cm/9 $\frac{1}{2}$ "	08-1555-24



Mathieu

08-1556-14
08-1556-17
08-1556-20
08-1556-24

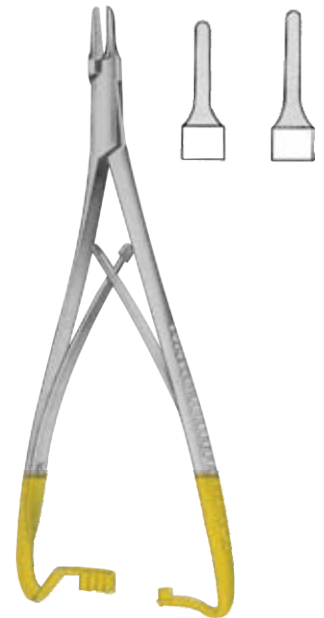

Mathieu-Ryder

08-1557-17
08-1557-20



Langenbeck

16cm/6 $\frac{1}{4}$ "	08-1558-16
18cm/7"	08-1558-18
20cm/8"	08-1558-20



Langenbeck-Ryder

08-1559-18
08-1559-20



Lichtenberg

08-1560-20

Suture Instruments

Micro Needle Holders with Tungsten Carbide Inserts
 Micro Nadelhalter mit Hartmetall-Wendeplatten

Porte-aiguilles Micro avec inserts en carbure de tungstène
 Titulares Micro agujas de tungsteno con Piezas de metal duro



08



Axhausen
 08-1561-18
 18.5 cm/7¼"



Zweifel
 08-1562-20 20 cm/8"
 08-1562-23 23 cm/9"



Toennis
 08-1563-18
 18 cm/7"



Mathieu-Kocher
 08-1564-14 14 cm/5 ½"
 08-1564-17 17 cm/6 ¾"
 08-1564-20 20 cm/8"

Suture Instruments

Micro Needle Holders with Tungsten Carbide Inserts
 Micro Nadelhalter mit Hartmetall-Wendeplatten

Porte-aiguilles Micro avec inserts en carbure de tungstène
 Titulares Micro agujas de tungsteno con Piezas de metal duro



08-1566-20 20 cm/8"
 08-1566-25 25 cm/10"

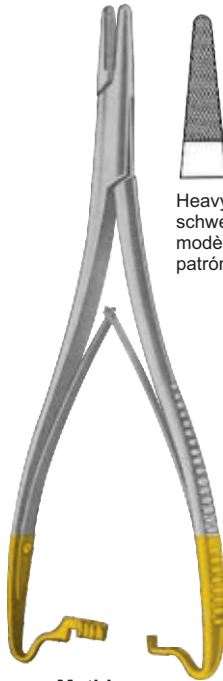

Heavy Pattern
 schwere Pattern
 modèle lourd
 patrón pesado

Mathieu
 08-1567-20 20 cm/8"
 08-1567-24 24 cm/9½"



Metzenbaum
 08-1568-17 17 cm/6¾"
 08-1568-20 20 cm/8"



Boynton
 08-1569-12
 12 cm/4¾"



Hosel
 08-1570-20 20 cm/8"
 08-1570-25 25 cm/10"



Arruga
 16 cm/6¼"

08-1571-16

08-1572-16

Suture Instruments

Micro Needle Holders with Tungsten Carbide Inserts
 Micro Nadelhalter mit Hartmetall-Wendeplatten

Porte-aiguilles Micro avec inserts en carbure de tungstène
 Titulares Micro agujas de tungsteno con Piezas de metal duro

08



Baby-Olsen-Hegar
 08-1573-11
 11.5 cm/4½"



Olsen-Hegar
 08-1574-14
 14 cm/5½"



Olsen-Hegar
 08-1575-17
 17 cm/6¾"



Olsen-Hegar
 08-1576-18
 19 cm/7½"



Gillies-Slim
 08-1577-14
 14.5 cm/5½"

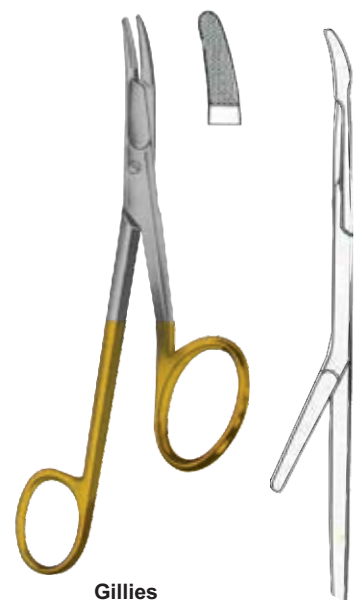

Gillies
 08-1578-16 L
 08-1578-16 R
 16 cm/6¼"

Suture Instruments

Ligature Needles
Ligature Needles

Aiguilles Ligatures
Agujas de ligadura

Left
links
Izquierda



20 cm/8"



08-1579-01



Sharp
scharf
net
agudo



08-1579-02

Right
rechts
droit
derecho



20 cm/8"



08-1580-01



blunt
stumpf
émousser
embotar



08-1580-02

Deschamps-Standard

Fine
feine
fin
multa



20 cm/8"



08-1581-01



Sharp
scharf
net
agudo



08-1581-02



08-1582-01



blunt
stumpf
émousser
embotar



08-1582-02

Deschamps



20 cm/8"

Suture Instruments

Ligature Needles
Ligature Needles

Aiguilles Ligatures
Agujas de ligadura



08

Left
links
links
Izquierda

Right
rechts
droit
derecho

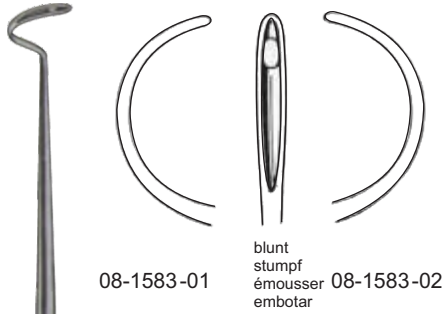

08-1583-01

08-1583-02

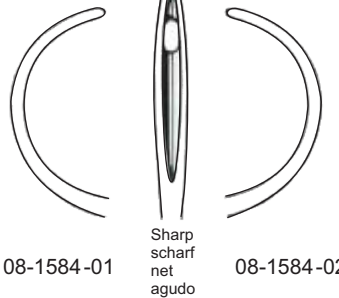

08-1584-01

08-1584-02

Deschamps

21 cm/8¼"

21 cm/8¼"

Left
links
links
Izquierda

Right
rechts
droit
derecho

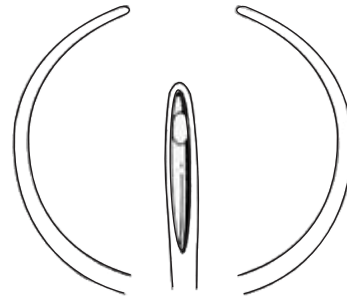

08-1585-01



08-1585-02

Deschamps
24 cm/9½"

Suture Instruments

Ligature Needles
Ligature Needles

Aiguilles Ligatures
Agujas de ligadura

Left
links
links
Izquierda

Right
rechts
droit
derecho

Left
links
links
Izquierda

Right
rechts
droit
derecho

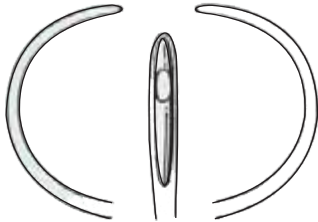

blunt
stumpf
émousser
embotar

08-1586-01 08-1586-02

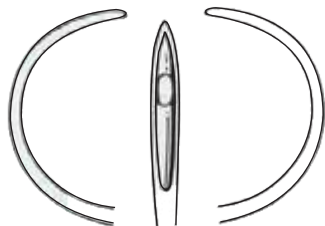

Sharp
scharf
net
agudo

08-1587-01 08-1587-02

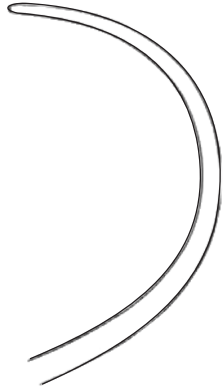
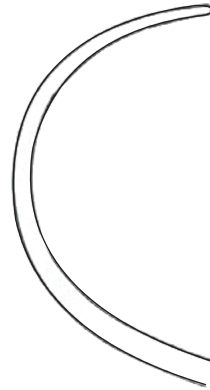

27 cm/10½"

Deschamps

27 cm/10½"



Deschamps
28 cm/11"

08-1588-01



08-1588-02

Suture Instruments

Ligature Needles
Ligature Needles

Aiguilles Ligatures
Agujas de ligadura



08

Left
links
links
Izquierda

Right
rechts
droit
derecho

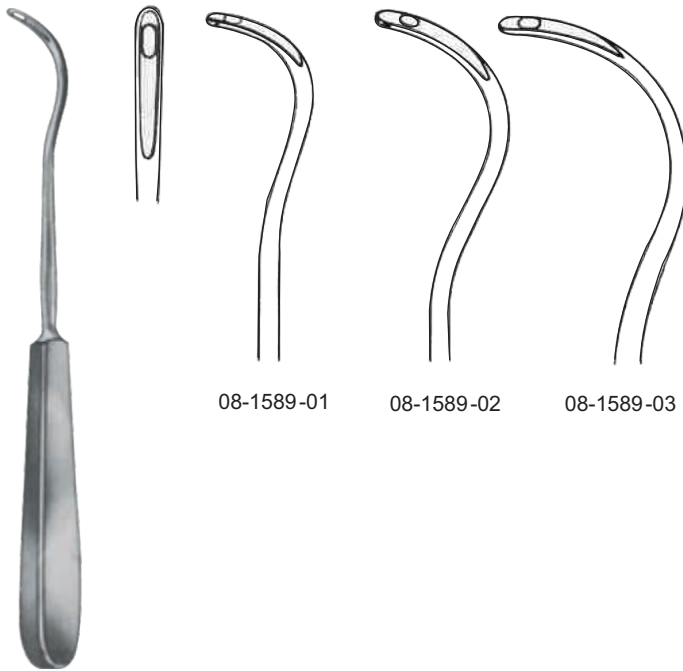

08-1589-01

08-1589-02

08-1589-03

Kocher
19 cm/7 1/2"



Kronecker
08-1590-01 13 cm/5" 08-1590-02

Left
links
links
Izquierda

Right
rechts
droit
derecho

Left
links
links
Izquierda

Right
rechts
droit
derecho

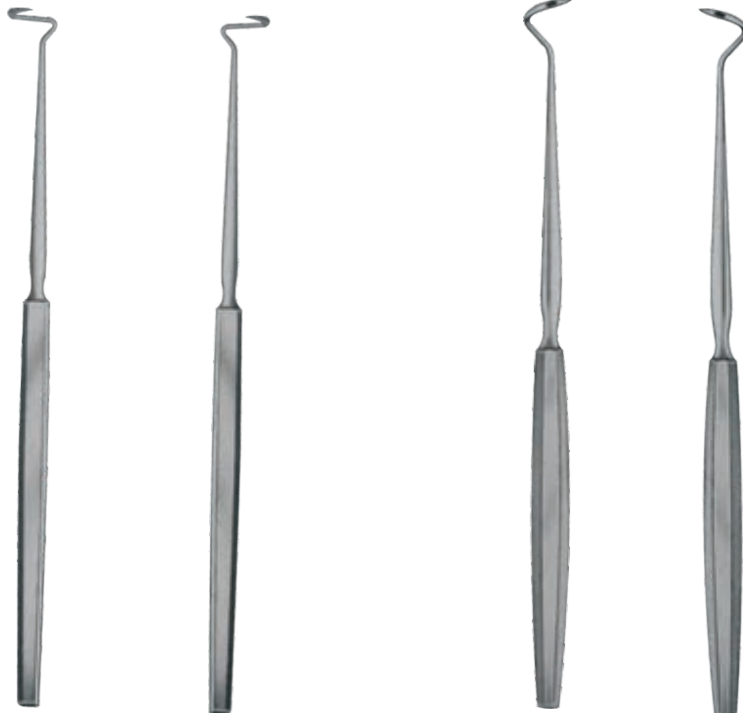

Dupuy-Weiss
08-1591-01 22 cm/8 3/4" 08-1591-02

Durham
08-1592-01 21 cm/8 1/4" 08-1592-02

Suture Instruments

Ligature Needles
Ligature Needles

Aiguilles Ligatures
Agujas de ligadura

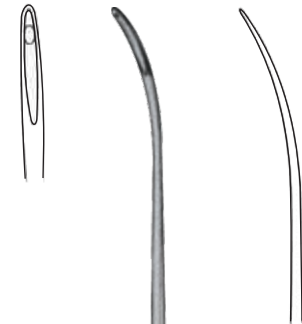

Flexible

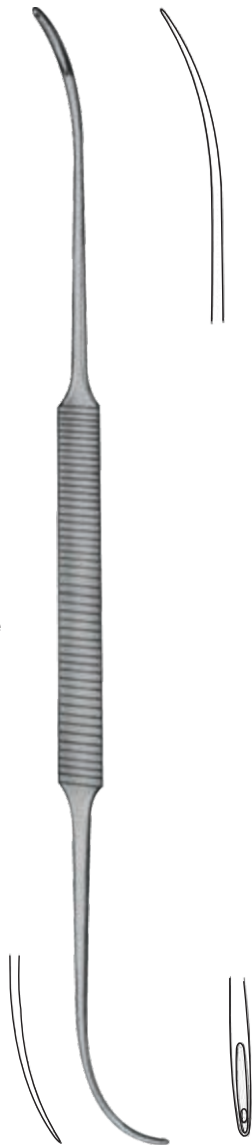

Schmieden-Dick
08-1595-32



Schmieden
08-1593-21
21 cm/8¼"



Flexible



08-1594-20
20 cm/8"



Cooper
08-1594-19
19 cm/7½"

Suture Instruments

Ligature Needles
Ligature Needles

Aiguilles Ligatures
Agujas de ligadura

08



With 3 needle
Mit 3-Nadel
Avec 3 aiguilles
Con 3 agujas

Young
08-1596-25 25 cm/10"



08-1596-01



08-1596-02



08-1596-03

Spare needle only
Ersparen Nadel nur
Epargnez seule aiguille
Repuesto aguja sólo



Reverdin
14 cm/5½"



Fig. 1
08-1597-01



Fig. 2
08-1597-02



Fig. 3
08-1597-03



Fig. 4
08-1597-04

Suture Instruments

Ligature Needles
Ligature Needles

Aiguilles Ligatures
Agujas de ligadura



Reverdin
19.5 cm/7 $\frac{3}{4}$ "



Fig. 1
08-1598-01



Fig. 2
08-1598-02



Fig. 3
08-1598-03



Fig. 4
08-1598-04



Reverdin
22.5 cm/8 $\frac{3}{4}$ "



Fig. 1
08-1599-01



Fig. 2
08-1599-02



Fig. 3
08-1599-03



Fig. 4
08-1599-04

Suture Instruments

Ligature Needles and Ligature Conductors
Ligature Needles and Ligature Dirigenten

Aiguilles Ligatures Ligatures et chefs d'orchestre
Agujas ligadura y ligadura Conductores

08

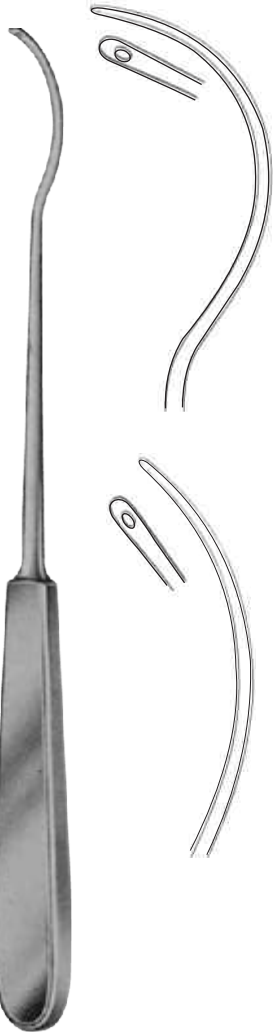

Brunner
08-1600-30
30 cm/12"

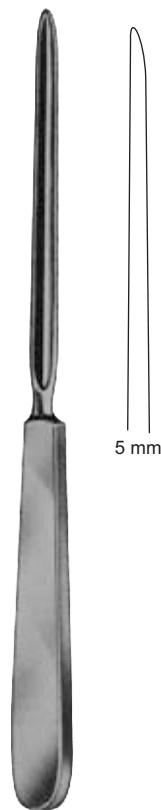

Payr
08-1601-22
22 cm/8¾"

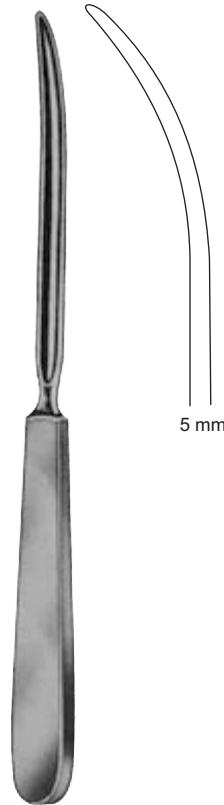

Payr
08-1602-22
22 cm/8¾"

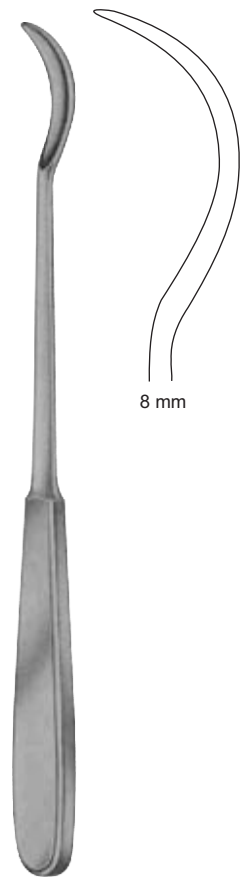

Brunner
08-1603-30
30 cm/12"

Suture Instruments

Ligature Needles and Ligature Conductors
Ligature Needles and Ligature Dirigenten

Aiguilles Ligatures Ligatures et chefs d'orchestre
Agujas ligadura y ligadura Conductores

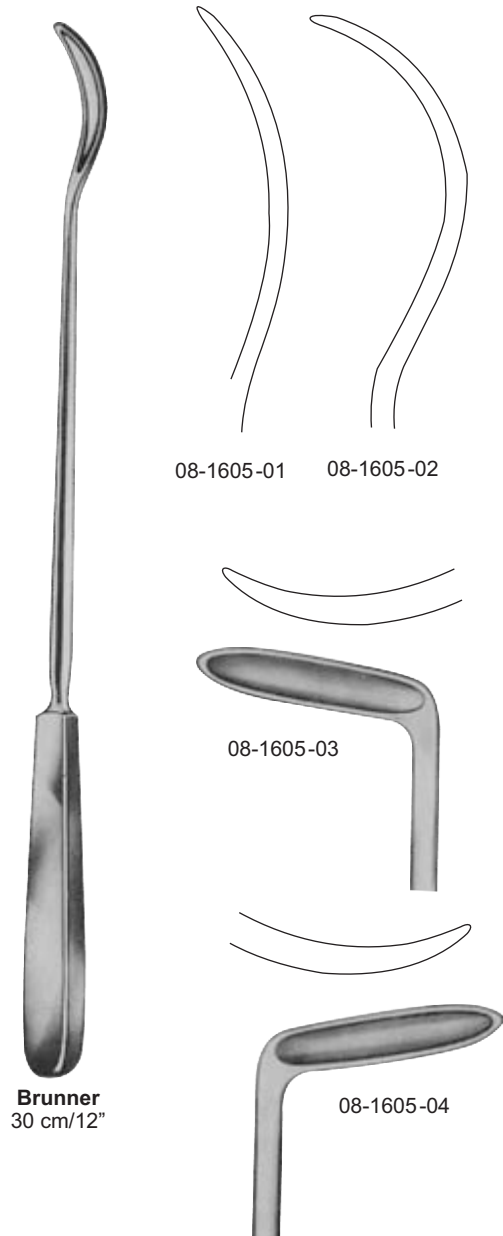
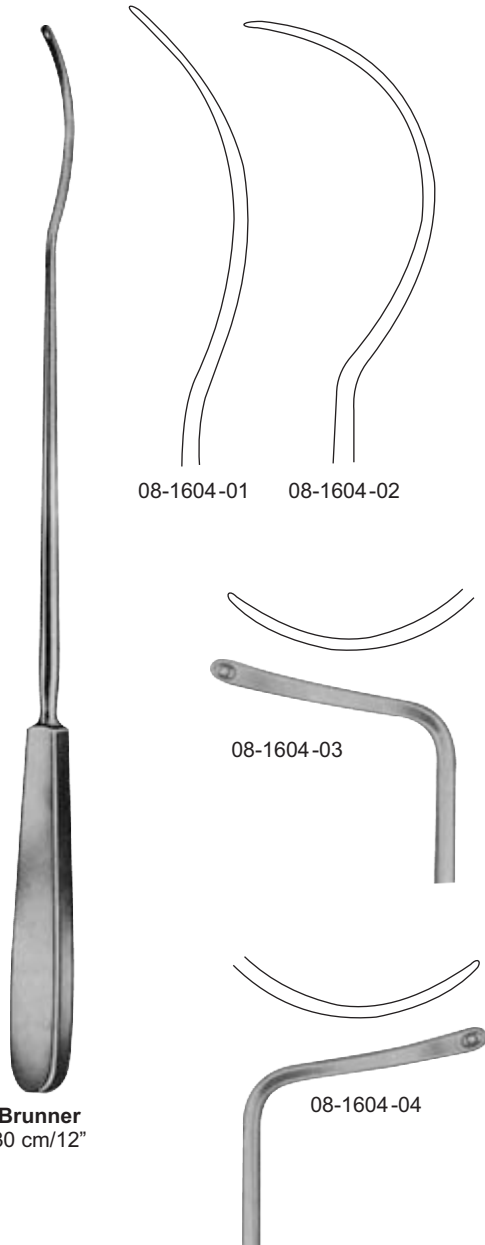

Suture Instruments

Ligature Conductors
Ligature Dirigenten

conducteurs Ligatures
Los conductores de ligadura



08

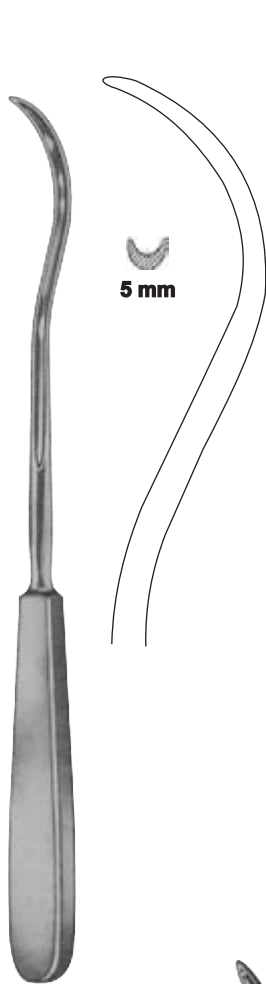

Kirschner
08-1606-25
25.5 cm/10"

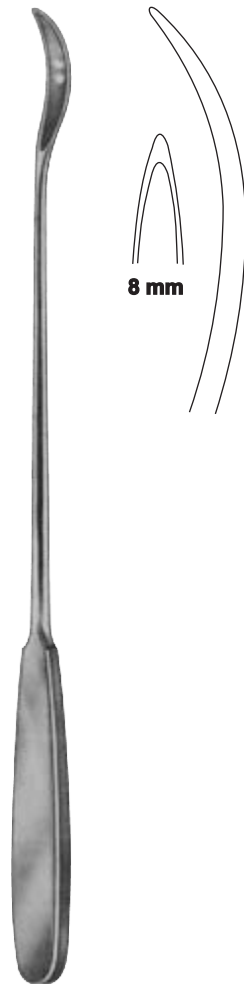

Brunner
08-1607-30
30 cm/12"

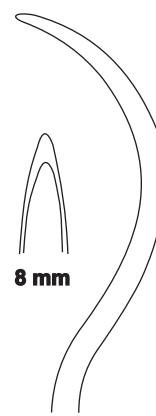

Brunner-Ferrozell
08-1608-18 18 cm/7"
08-1608-27 27 cm/10½"



Schmieden-Payr
08-1609-19
19 cm/7½"



Schmieden
08-1610-19
19 cm/7½"

Suture Instruments

Ligature Conductors, Knot Tiers and Ligatures
Ligature Dirigenten, Knot Tiers und Ligaturen

Conducteurs ligatures, les niveaux de noeud et Ligatures
Conductores de ligadura, Tiers nudo y ligaduras

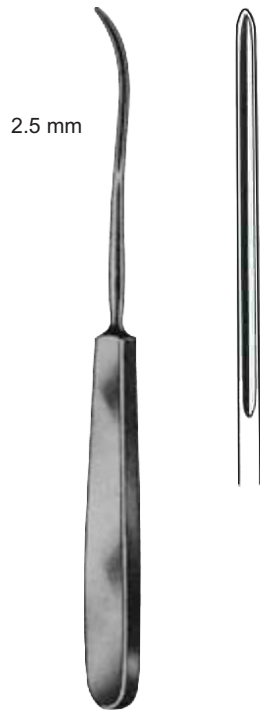

König
08-1611-19
19.5 cm/7¾"

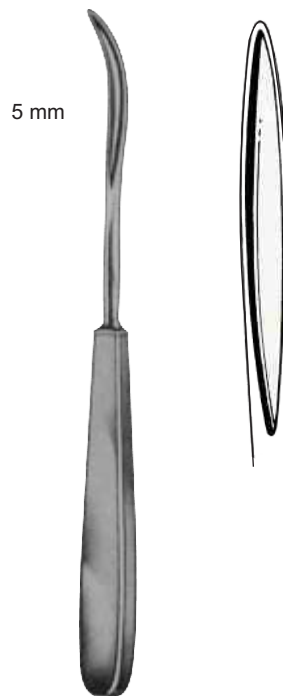

König
08-1612-19
19.5 cm/7¾"

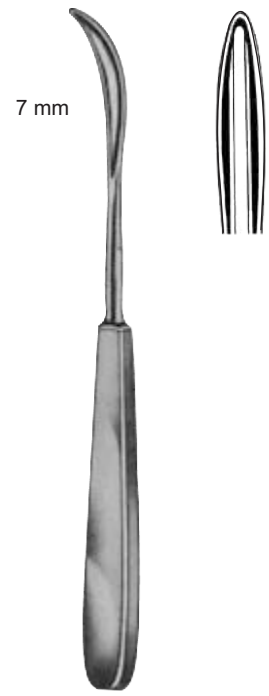

König
08-1613-20
20 cm/8"



Wien
08-1614-23
23.5 cm/9¼"



Bozemann
08-1615-21
21 cm/8¼"



08-1616-23
23 cm/9"

Suture Instruments

Clip Applying Forceps
Clipanlegezange

Fixez Application Forceps
Clip La aplicación de fórceps

08



Michel
08-1617-12
12 cm/4¾"



Michel Modif
08-1618-12
12.5 cm/5"



Collin
08-1619-13
13 cm/5"



Richter-Heath
08-1620-14
14 cm/5½"



Child
08-1621-18
18 cm/7"



Child
08-1622-18
18 cm/7"



Michel
08-1623-12
12 cm/4¾"



Michel
08-1624-12
12 cm/4¾"



Wachenfeldt
08-1625-12
12.5 cm/5"



Hagenbarth
08-1626-12
12.5 cm/5"

Diagnostic Instruments

Sensibility Instruments and Stethoscopes
Sensibility Instrumente und Stethoskope

Instruments sensibilité et Stéthoscopes
Los instrumentos de sensibilidad y Fonendoscopios



Pinard
09-1630-01
18cm/7"



Pinard
09-1631-02
15cm/6"



Wartenberg
09-1632-04
19cm/7½"



Aly
09-1633-03
17cm/6¾"



Weber
09-1634-05
9cm/3½"



Chest piece only
Bruststück nur
Pièce de poitrine seulement
Pecho única pieza
05-1006-06

Duplex
09-1635-06



Chest piece only
Bruststück nur
Pièce de poitrine seulement
Pecho única pieza
05-1007-07

Bowles
09-1636-07

Diagnostic Instruments

Percussion Hammers
Perkussionshämmer

Marteaux à percussion
Martillos de percusión



09



Buck
09-1637-08
18.5cm/7½"

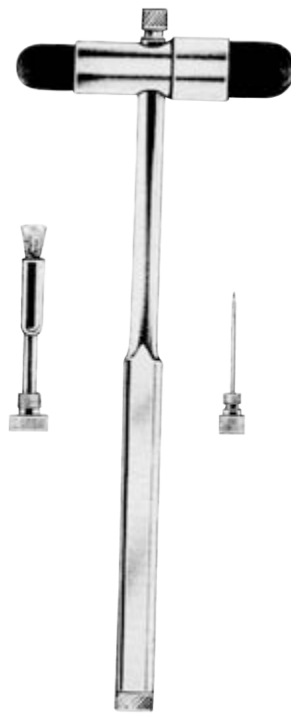

Buck
09-1638-09
18cm/9½"



Dejerine
09-1639-10
20cm/8"



Berliner
09-1640-11
20cm/8"



Taylor
09-1641-12
20cm/8"



Traube
09-1642-13
16cm/6¼"



Traube
09-1643-14
16cm/6½"

Diagnostic Instruments

Percussion Hammers & Head Lamp
 Perkussionshämmer & Stirnlampe

Marteaux à percussion et lampe frontale
 Martillos de percusión y cabeza de la lámpara



Rabiner
 09-1644-25
 25.5cm / 10"



Babinsky
 09-1645-22
 22 cm / 8 1/4"



Queen Sqaure
 09-1646-25
 25 cm / 10 1/4"



National Hospital
 09-1647-33
 33 cm / 13"

Head Mirrors



Ziegler
 09-1648-18



09-1649-19



09-1650-20



09-1651-21

Diagnostic Instruments

Dynamometers, Goniometers and Calipers
 Dynamometer, Winkelmesser und Messschieber

Dynamomètres, goniomètres et les étrières
 Dinamómetros, goniómetros y pinzas de freno



09



Bertillon
 09-1652-22
 32cm/12¾"



Caroll
 09-1653-23
 14cm/5½"



Townley
 09-1654-24
 10cm/4"

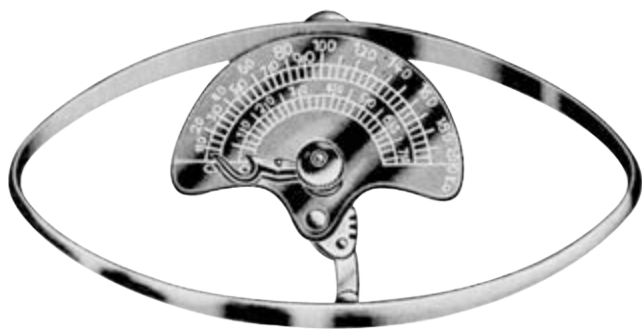

Collin
 09-1655-25
 for children



Moltgen
 09-1657-26



Collin
 09-1656-25 A
 for adults

09-1658-27 15cm/6"
 09-1658-28 30cm/12"

Anaesthesia Instruments

Laryngoscopes
Laryngoskope

Laryngoscopes
Laringoscopios

MACINTOSH FIBER OPTIC



10-1659-29

ADVANTAGES

Fiber optic blades with German Bulb
Fiber optic illumination
assembly is detachable
and is easy to clean.
Maintain and re-polished.
Thousands of fiber strings
are firmly secured in stainless steel
pipe cover which saves
from damage or breakage.



Fig.4



Fig.3



Fig.2



Fig.1

MILLER FIBER OPTIC



10-1660-30



Fig.4



Fig.3



Fig.2



Fig.1

Anaesthesia Instruments

Laryngoscopes
Laryngoskope

Laryngoscopes
Laringoscopios



10

MILLER CONVENTIONAL



10-1661-01

ADVANTAGES

Handles

Brass
Universal Fitting with
Non Magnetic pin

Blades

Stainless Steel
Non Magnetic
with german bulb



Fig.4



Fig.3



Fig.2



Fig.1

MACINTOSH CONVENTIONAL



10-1662-02



Fig.4



Fig.3



Fig.2



Fig.1

Anaesthesia Instruments

Laryngoscopes
Laryngoskope

Laryngoscopes
Laringoscopios

DIAGNOSTIC ENT SET



10-1663-33

OTOSCOPE SET WITH CASE



10-1664-34

Anaesthesia Instruments

Laryngoscopes
Laryngoskope

Laryngoscopes
Laringoscopios



10

Laryngoscope Set, Handle & Blades



10-1665-00



Miller Baby
10-1666-00

FIBEROPTIC HANDLES



Fig.1



Fig. 2

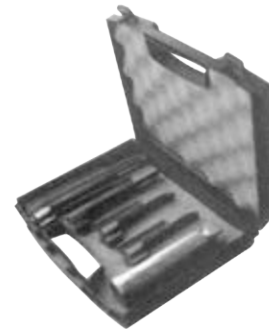

Fig. 3



Fig. 4

10-1668-00



10-1667-00
Magil Set of 4 Blade
Size : 1,2,3,4 1Medium Hadle
1 Small & 1Large spare Lamp packed in
Strong Plastic Casing with Foam Inserting

ADVANTAGES

Choice of Xenon & Halogen lamps available.
All types of standard lamp threads available.
Easy to replace lamp
Handles fitting is compatible

ADVANTAGES

High quality long life handles
Handles fitting is compatible

CONVENTIONAL HANDLES



Fig.1



Fig. 2



Fig. 3



Fig. 4

10-1668-39

TONGUE DEPRESSOR



10-1668-A

PEN TORCH



10-1668-B

MINI OTOSCOPE FIBER OPTICS



10-1668-C



10-1668-D



10-1668-E

Available in colour



10-1668-F

10-1668-G

10-1668-H

Anaesthesia Instruments

Otosopes
Otoskope

Otosopes
Otoskopios



10

METAL BODY OTOSCOPIES



10-1668-J

10-1668-K

OPHTHALMOSCOPIES



10-1668-M

10-1668-N



10-1668-L

Anaesthesia Instruments

Suction Tubes
Saugrohre

Tubes d'aspiration
tubos de succión

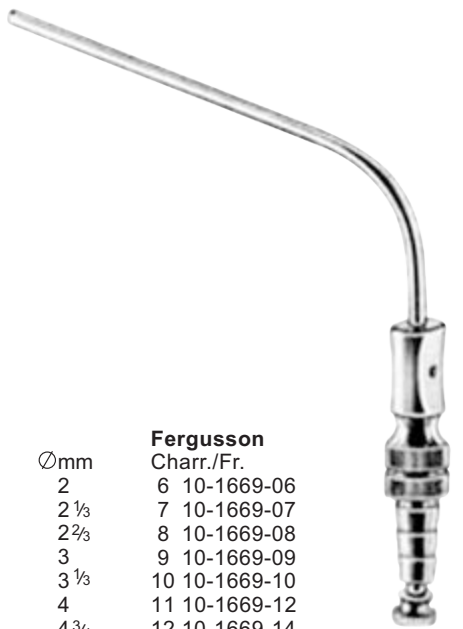

Ømm	Fergusson Charr./Fr.
2	6 10-1669-06
2 1/3	7 10-1669-07
2 2/3	8 10-1669-08
3	9 10-1669-09
3 1/3	10 10-1669-10
4	11 10-1669-12
4 3/4	12 10-1669-14

17cm/6 3/4"



Ømm	Frazier Charr./Fr.
2	6 10-1670-06
2 1/3	7 10-1670-07
2 2/3	8 10-1670-08
3	9 10-1670-09
3 1/3	10 10-1670-10
4	12 10-1670-12
4 3/4	14 10-1670-14
5 1/4	16 10-1670-16

17cm/6 3/4"

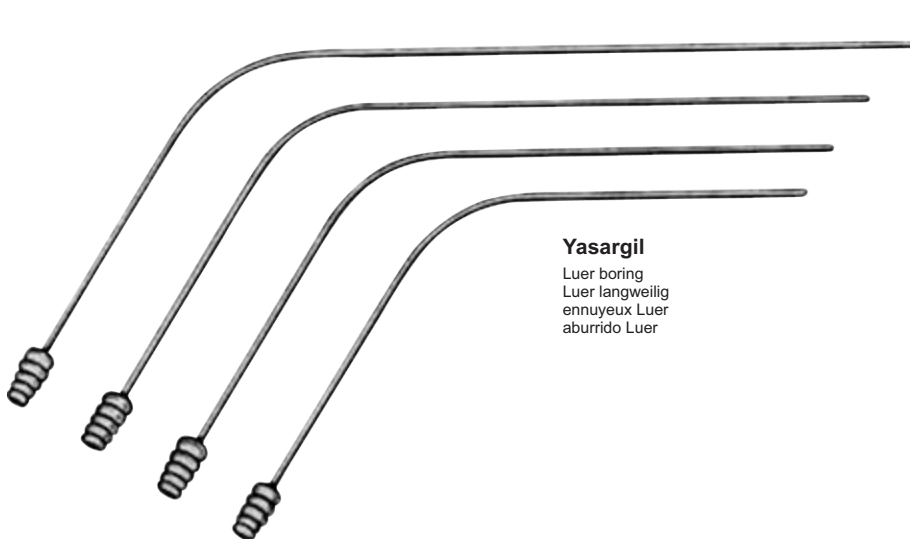

Yasargil
Luer boring
Luer langweilig
ennuyeux Luer
aburrido Luer

usable length cm	Ømm diam
13	1.5 10-1671-13
15	1.5 10-1671-15
18	1.5 10-1671-18
22	1.5 10-1671-22
13	2.0 10-1672-13
15	2.0 10-1672-15
18	2.0 10-1672-18
22	2.0 10-1672-22
13	2.5 10-1673-13
15	2.5 10-1673-15
18	2.5 10-1673-18
22	2.5 10-1673-22
13	3.5 10-1674-13
15	3.5 10-1674-15
18	3.5 10-1674-18
22	3.5 10-1674-22
18	4.5 10-1674-18

Ømm	
○ 1.7	10-1675-17
○ 2.5	10-1676-25
○ 3.5	10-1677-35

malleable
formbar
malléable
maleable

Yasargil

Anaesthesia Instruments

Suction Tubes
Saugrohre

Tubes d'aspiration
tubos de succión

10



malleable, black
Temperguss, schwarz
malléable, noire
maleable, negro

∅	
2 mm	10-1678-02
3 mm	10-1678-03
4 mm	10-1678-04
5 mm	10-1678-05
	19.5cm/7"

Brain Suction Tubes
Gehirn Saugschläuche
Tubes d'aspiration du cerveau
Los tubos de succión del cerebro



∅	Plester
1.5 mm	10-1680-15
2.0 mm	10-1680-20
2.5 mm	10-1680-25
3.0 mm	10-1680-30
	19.5cm/7¾"



Adson
∅4 mm

Adson
10-1679-50
21 cm/8 1/4"



∅	Frazier
2.0 mm	10-1681-20
2.5 mm	10-1681-25
3.0 mm	10-1681-30
	13cm/5"

Anaesthesia Instruments

Suction Tubes
Saugrohre

Tubes d'aspiration
tubos de succión

Ø 8 mm



Poole
10-1682-59
22cm/8¾"

Ø 10 mm



Poole
10-1683-60
22cm/8¾"

Ø 6 mm



Baby-Poole
10-1684-61
20cm/8"

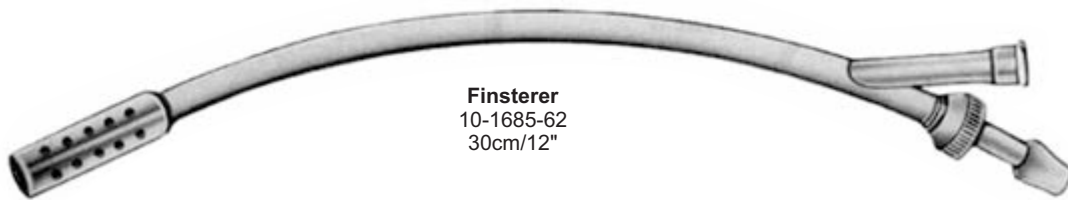

Finsterer
10-1685-62
30cm/12"

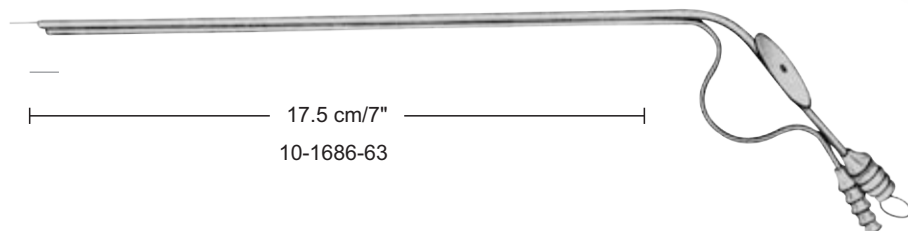

17.5 cm/7"
10-1686-63

Anaesthesia Instruments

Suction Tubes
Saugrohre

Tubes d'aspiration
tubos de succión



10



Fig. 3
10-1687-03



Fig. 2
10-1687-02



Fig. 1
10-1687-01



Fig. 0
10-1687-00



Yankauer
10-1688-53



with stopcock
mit Hahn
avec robinet d'arrêt
con llave de paso

Yankauer
10-1689-54
27cm/10½"



Yankauer
10-1690-55
27cm/10½"



Andrew-Pynchon
10-1691-56
23 cm/9"



Nuboer
10-1692-57
21cm/8¼"



Nuboer
10-1693-58
21cm/8¼"

Anaesthesia Instruments

Suction Tubes
Saugrohre

Tubes d'aspiration
tubos de succión

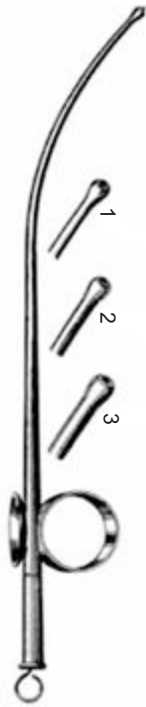

Magill

10-1694-01=20cm/8"
10-1694-02=20cm/8"
10-1694-03=20cm/8"

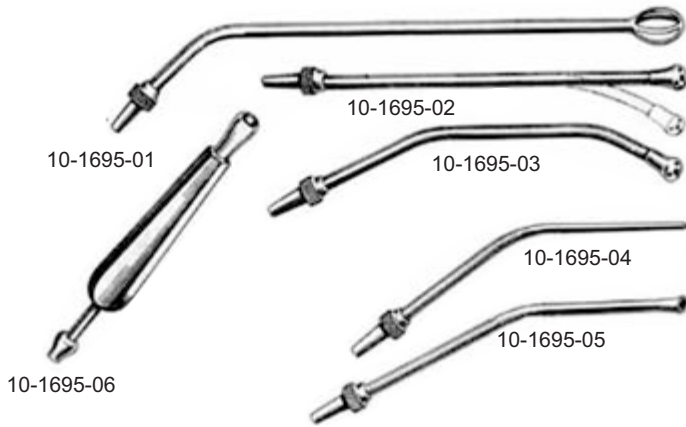

**Yankauer universal
Complete Set
10-1695-65**



**Yankauer
10-1696-34
34.5cm/13¼"**



**Simpson-Smith
10-1697-67**



**Millin
10-1698-30
30cm/12"**

Anaesthesia Instruments

Nasal and Ear Cannulas
Nasen-und Ohr-Kanülen

Nasen-und Ohr-Kanülen...
Cánulas nasales y del oído



10



Magill

10-1699-69
25cm/10"

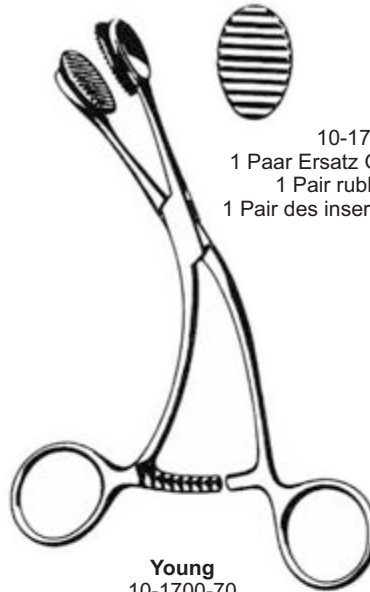

Young
10-1700-70
17cm/6 3/4"

10-1700-70
1 Paar Ersatz Gummieinsätze
1 Pair rubber inserts
1 Pair des inserts en caoutchouc



Collin
10-1701-16 16cm/6 1/2"
10-1701-17 17cm/6 3/4"
10-1701-19 19cm/7 1/2"

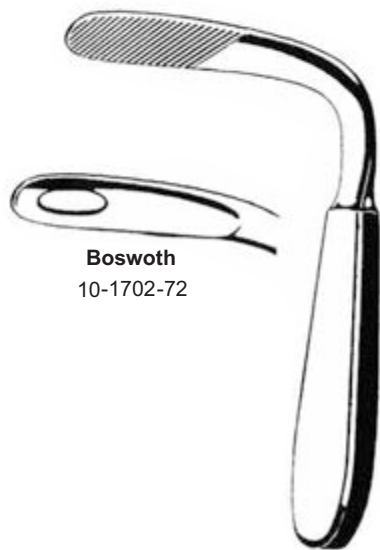

Bosworth
10-1702-72

Tobold
10-1702-14
14.5cm/5 1/2"



Sternberg
10-1703-12 12cm/6 3/4"
10-1703-14 14cm/5 1/2"
10-1703-16 16cm/6 1/4"



Connel
10-1704-01 Child
10-1704-02 Adult

Anaesthesia Instruments

Cheek Retractors - Tongue depressors-Catheter forceps
Wangenhalter - Zungenspatel-Katheter Zange

Écarteurs - Langue abaisse-cathéter forceps
Los retractores mejilla - Lengua depresores-catéter fórceps

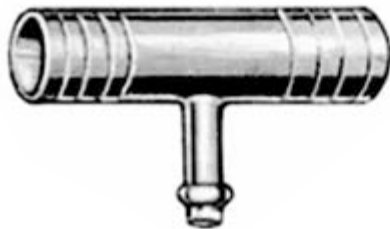

Ayre
10-1705-01 Small
10-1704-02 Medium
10-1704-03 Large

Small	Medium	Large
Klein	Medium	groß
petit	moyen	grand
pequeño	medio	grande



Cobb
10-1706-01 Small
10-1706-02 Medium
10-1706-03 Large

Small	Medium	Large
klein	Medium	groß
petit	moyen	grand
pequeño	medio	grande



Mitchell
10-1707-18
10-1707-20
38mm

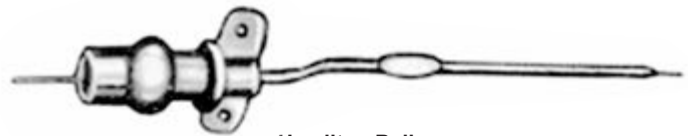

Hamilton Bailey
10-1708-01 Infant
10-1708-02 Child
10-1708-03 Adult

Infant	Child	Adult
Säugling	Kind	Erwachsene
nourrisson	enfant	adulte
infantil	niño	adulto

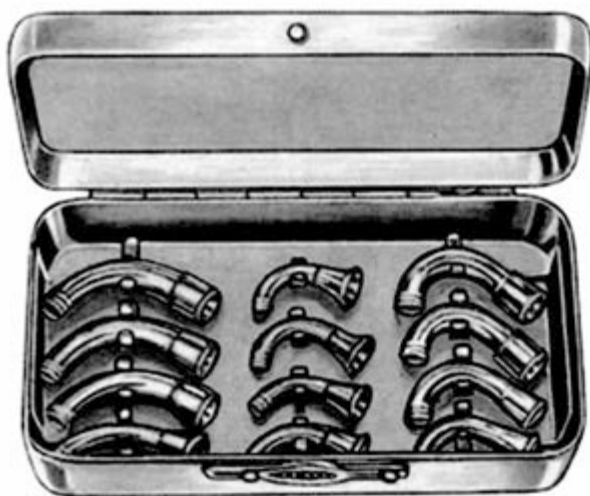

Magill
Connexion Set
09-1709-00



Magill (Nasal)		Magill (Nasal)	
	mm dia		mm dia
10-1710-01	5.5	10-1711-01	5.5
10-1710-02	6.5	10-1711-02	6.5
10-1710-03	7.5	10-1711-03	7.5
10-1710-04	8.0	10-1711-04	8.0
10-1710-05	8.5	10-1711-05	8.5
10-1710-06	9.5	10-1711-06	9.5
10-1710-07	10.0	10-1711-07	10.0
10-1710-08	10.5	10-1711-08	10.5

Puncture Instruments

Trocars
Trocare

Trocarts
trócares



11



Universal

11-1712-03 =3 Set of 3
11-1712-04 =4 Set of 4

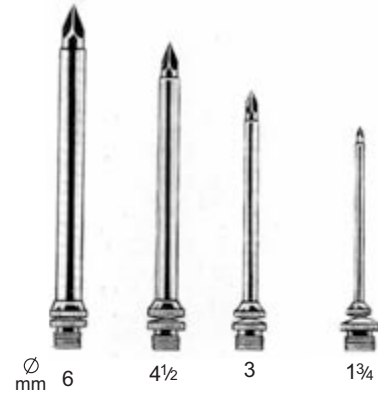
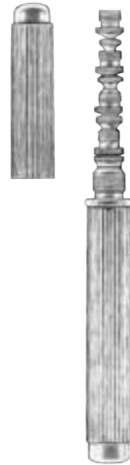

11-1713-03 =3 Set of 3
11-1713-04 =4 Set of 4



Standard (Nelson)

Ømm	11cm/4 1/2"
3.0	11-1714-30
3.5	11-1714-35
4.0	11-1714-40
4.5	11-1714-45
5.0	11-1714-50
5.5	11-1714-55
6.0	11-1714-60



Standard (Nelson)

Ømm	12cm/4 3/4"
3.0	11-1715-30
3.5	11-1715-35
4.0	11-1715-40
4.5	11-1715-45
5.0	11-1715-50
5.5	11-1715-55
6.0	11-1715-60



Standard (Nelson)

Ømm	12cm/4 3/4"
3.0	11-1716-30
3.5	11-1716-35
4.0	11-1716-40
4.5	11-1716-45
5.0	11-1716-50
5.5	11-1716-55
6.0	11-1716-60

Puncture Instruments

Trocars
Trokare

Trocarts
trócares

Ø13.5mm



Pean
11-1717-16
16cm/6¼"

Ø 2 mm



Landau
11-1718-19
19cm/7½"

Ø 2 mm



Landau
11-1719-16
16cm/6¼"

Ø 8 mm



Buelau
11-1720-24
24cm/9½"



Lichtwitz
11-1721-19
19cm/7½"

Puncture Instruments

Trocars
Trokare

Trocarts
trócares

11



Nelson

Ø mm	21cm/8¼"
7.5	11-1722-07
9.0	11-1722-09
10.5	11-1722-10
12.0	11-1722-12



Ochsner

Ø mm	14.5cm/5½"
4.0	11-1723-40
4.6	11-1723-46
5.5	11-1723-55
6.5	11-1723-65

Ø 5.5 mm



Krause
 11-1724-15
 15cm/6"

Ø 2.25 mm

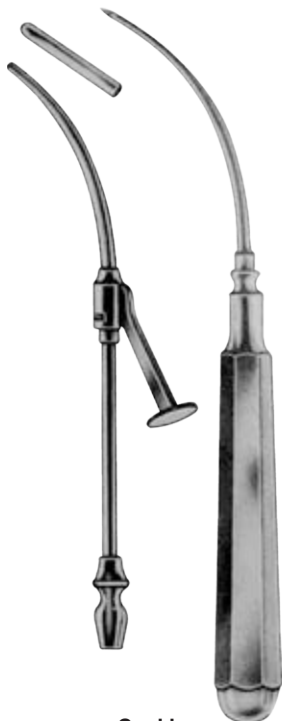

Coakley
 11-1725-16
 16cm/6¼"

Ø 1.8 mm



Douglas
 11-1726-11
 11.5 cm/4½"



11-1727-11
 11.5 cm/4½"



Ø **Pierce**

mm	
3.0	11-1728-03
4.0	11-1728-04
5.0	11-1728-05

General Instruments

Plaster Knives, Saw and Cast Breakers
Gips Messer, Säge-und Cast Breakers

Breakers Couteaux plâtre, de sciage et de Cast
Cuchillos de yeso, de sierra y el Elenco Breakers



Hopkins
12-1728-20
20 cm/8"



Esmarch
12-1729-18
18 cm/7"



Reiner
12-1730-18
18.5 cm/7¼"

Plaster Saw
Gipssäge
plâtre de scie
yeso Saw



Engel
12-1731-14
14cm/5½"

General Instruments

Plaster Spreaders
Gips Spreizer

Epan dage de plâtre
Separadores de yeso

12



Hennig
12-1732-28
28 cm/11"

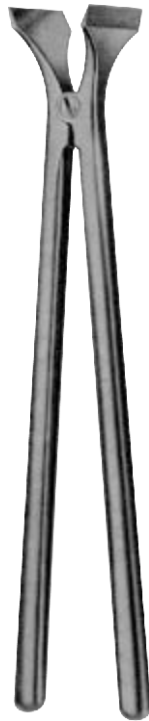

Beeson
12-1733-30
30 cm/12"



Haglund-Stille
12-1734-28
28 cm/11"



Mod. USA
12-1735-23
23 cm/9"

General Instruments

Plaster Instruments
Gips Instruments

Instruments de plâtre
Instrumentos de yeso



Wolf
12-1736-18 18cm/7"
12-1736-24 24cm/9½"



Stille
12-1737-24
24cm/9½"



Stille
12-1738-23 23cm/9"
12-1738-26 26cm/9¼"
12-1738-37 37cm/14½"

Bone Instruments

Bone Chisels & Gouges
Knochenmeißeln & Gouges

Bone ciseaux et gouges
Cinceles y Gouges



12



Inspector
16 cm/6¼"

- 12-1739-03
3mm
- 12-1739-05
5mm
- 12-1739-07
7mm
- 12-1739-09
9mm



Passow
12 cm/4¾"

12-1740-02
2.5mm

12-1740-03
3.5mm



- Hautant**
- 12-1741-02 2mm
 - 12-1741-04 4mm
 - 12-1741-05 5mm
 - 12-1741-06 6mm
 - 12-1741-08 8mm
 - 12-1741-10 10mm
 - 12-1741-12 12mm
 - 13 cm/5¼"



- mm
- 06 12-1742-06
 - 12 12-1742-12
 - 18 12-1742-18



- Mod. USA**
- 12-1743-06
 - 12-1743-12
 - 12-1743-18
 - 16 cm/6¼"



- 12-1744-06
- 12-1744-12
- 12-1744-18

Bone Instruments

Bone Chisels, Gouges and Osteotomes
Knochenmeißeln, Gouges und Osteotome

Bone ciseaux, gouges et ostéotomes
Cinceles, formones y osteotomos



Width
Breite
largeur
ancho

mm			
04	12-1745-04	12-1746-04	12-1747-04
06	12-1745-06	12-1746-06	12-1747-06
08	12-1745-08	12-1746-08	12-1747-08
10	12-1745-10	12-1746-10	12-1747-10
12	12-1745-12	12-1746-12	12-1747-12
14	12-1745-14	12-1746-14	12-1747-14
16	12-1745-16	12-1746-16	12-1747-16
	13.5 cm/5 1/4"		



mm	Partsch		Partsch	
02	12-1748-02	12-1749-02	12-1750-02	12-1751-04
03	12-1748-03	12-1749-03	12-1750-03	12-1751-06
04	12-1748-04	12-1749-04	12-1750-04	12-1751-08
05	12-1748-05	12-1749-05	12-1750-05	12-1751-10
06	12-1748-06	12-1749-06	12-1750-06	12-1751-12
07	12-1748-07	12-1749-07	12-1750-07	12-1751-14
08	12-1748-08	12-1749-08	12-1750-08	12-1751-16
	13.5 cm/5 1/4"		17 cm/6 3/4"	

12-1752-04	4mm
12-1752-06	6mm
12-1752-08	8mm
12-1752-10	10mm
12-1752-12	12mm
12-1752-14	14mm



Poirioer
16cm/6 "

12-1753-02	2mm
12-1753-04	4mm
12-1753-06	6mm
12-1753-08	8mm
12-1753-10	10mm
12-1753-12	12mm
12-1753-14	14mm



Poirioer
16cm/6 "

12-1754-04	4mm
12-1754-06	6mm
12-1754-08	8mm
12-1754-10	10mm
12-1754-12	12mm
12-1754-14	14mm



Proirier Triuat
20cm/8"

Bone Instruments

Bone Chisels, Gouges and Osteotomes
Knochenmeißeln, Gouges und Osteotome

Bone ciseaux, gouges et ostéotomes
Cinceles, formones y osteotomos



12









Hautant
13 cm/5"

-  12-1755-02 2 mm
-  12-1755-04 4 mm
-  12-1755-05 5 mm
-  12-1755-06 6 mm
-  12-1755-08 8 mm
-  12-1755-10 10mm
-  12-1755-12 12mm











Judet
22 cm/8¾"

-  12-1756-10 10mm
-  12-1756-15 15mm
-  12-1756-20 20mm
-  12-1756-25 25mm
-  12-1756-30 30mm
-  12-1756-35 35mm









Cauchoix
25 cm/10"

-  12-1757-08 8 mm
-  12-1757-10 10mm
-  12-1757-12 12mm
-  12-1757-14 14mm
-  12-1757-16 16mm
-  12-1757-18 18mm
-  12-1757-20 20mm
-  12-1757-25 25mm



Cauchoix
25 cm/10"

-  12-1758-16 16mm
-  12-1758-18 18mm
-  12-1758-20 20mm
-  12-1759-16 16mm
-  12-1759-18 18mm
-  12-1759-20 20mm





Bone Instruments

Bone Chisels, Gouges and Osteotomes
Knochenmeißeln, Gouges und Osteotome

Bone ciseaux, gouges et ostéotomes
Cinceles, formones y osteotomos











Farabeuf
21 cm/8 $\frac{1}{4}$ "

-  12-1760-10 10mm
-  12-1760-15 15mm
-  12-1760-20 20mm
-  12-1760-25 25mm
-  12-1760-30 30mm





Farabeuf
25 cm/10"

-  12-1761-06 6mm
-  12-1761-08 8mm
-  12-1761-10 10mm
-  12-1761-12 12mm
-  12-1761-15 15mm
-  12-1761-20 20mm
-  12-1761-25 25mm
-  12-1761-30 30mm



Maceven
20 cm/8"

-  12-1762-10 10mm
-  12-1762-15 15mm
-  12-1762-20 20mm

Bone Instruments

Bone Chisels, and Gouges
Knochenmeißeln, und Gouges

Bone ciseaux, et gouges
Cinceles, formones y



12



Lexer
27.5 cm/10¾"

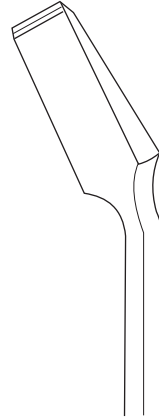
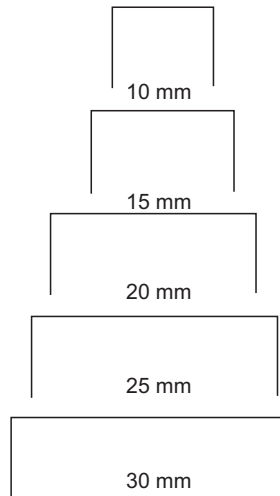

- 12-1763-10
- 12-1763-15
- 12-1763-20
- 12-1763-25
- 12-1763-30

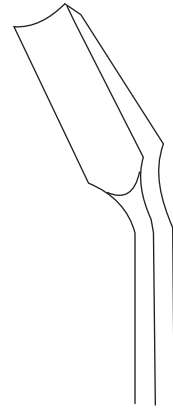

- 12-1764-10
- 12-1764-15
- 12-1764-20
- 12-1764-25
- 12-1764-30



Alexander
18 cm/7"

- 12-1765-04
- 12-1765-06
- 12-1765-08
- 12-1765-10
- 12-1765-12
- 12-1765-14

- mm
- 04
- 06
- 08
- 10
- 12
- 14



- 12-1766-04
- 12-1766-06
- 12-1766-08
- 12-1766-10
- 12-1766-12
- 12-1766-14

Bone Instruments

Bone Chisels, and Gouges Osteotomes Bone ciseaux, et gouges ostéotomes
 Knochenmeißeln, und Gouges Osteotome Cinceles, formones y osteotomos

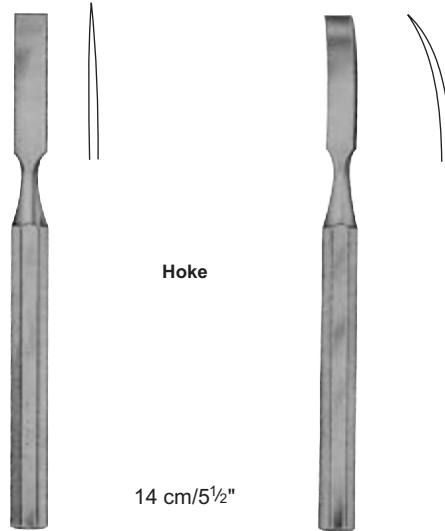

Hoke

14 cm/5½"

	mm	
12-1767-02	2	12-1768-02
12-1767-03	3	12-1768-03
12-1767-04	4	12-1768-04
12-1767-05	5	12-1768-05
12-1767-06	6	12-1768-06
12-1767-07	7	12-1768-07
12-1767-08	8	12-1768-08



Smith-Petersen
20 cm/8"



mm				
06	12-1769-06	12-1770-06	12-1771-06	12-1772-06
09	12-1769-09	12-1770-09	12-1771-09	12-1772-09
13	12-1769-13	12-1770-13		
14			12-1771-14	12-1772-14
16	12-1769-16	12-1770-16	12-1771-16	12-1772-16
19	12-1769-19	12-1770-19	12-1771-19	12-1772-19
25	12-1769-25	12-1770-25	12-1771-25	12-1772-25
32	12-1769-32	12-1770-32	12-1771-32	12-1772-32

Bone Instruments

Bone Chisels, and Gouges Osteotomes
Knochenmeißeln, und Gouges Osteotome

Bone ciseaux, et gouges ostéotomes
Cinceles, formones y osteotomos



12



Lambotte

	mm	
12-1773-04	04	12-1774-04
12-1773-06	06	12-1774-06
12-1773-08	08	12-1774-08
12-1773-10	10	12-1774-10
12-1773-13	13	12-1774-13
12-1773-16	16	12-1774-16
12-1773-18	18	12-1774-18
12-1773-20	20	12-1774-20
12-1773-25	25	12-1774-25
12-1773-30	30	12-1774-30
12-1773-38	38	12-1774-38
12-1773-44	44	12-1774-44
12-1773-50	50	12-1774-50
24 cm/9½"		23 cm/9"

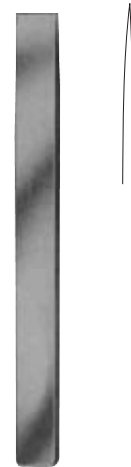

Mini-Lambotte

	mm	
12-1775-02	02	12-1776-02
12-1775-03	03	12-1776-03
12-1775-04	04	12-1776-04
12-1775-06	06	12-1776-06
12-1775-08	08	12-1776-08
12-1775-10	10	12-1776-10
12-1775-12	12	12-1776-12
12-1775-15	15	12-1776-15
12.5 cm/5"		17 cm/6¾"



Mini-Lexer

	mm	
12-1777-04	04	12-1778-04
12-1777-06	06	12-1778-06
12-1777-08	08	12-1778-08
12-1777-10	10	12-1778-10
12-1777-12	12	12-1778-12
18 cm/7"		



Lexer

	mm	
12-1779-05	05	12-1780-05
12-1779-07	07	12-1780-07
12-1779-10	10	12-1780-10
12-1779-15	15	12-1780-15
12-1779-20	20	12-1780-20
12-1779-25	25	12-1780-25
12-1779-30	30	12-1780-30
22 cm/8¾"		



Bone Instruments

Bone Chisels, and Gouges
Knochenmeißeln, und Gouges

Bone ciseaux, et gouges
Cinceles, formones y



Chisel
12-1781-20
24.5 cm/9¾"
20 mm



Chisel-Curved
12-1782-20
26.5 cm/10½"
20 mm

Gouge for the removing of
broken screws
Hohlmeißel für das Entfernen von
abgebrochener Schrauben
Gouge pour la suppression de vis cassées
Gubia para la remoción de tornillos rotos



12-1783-22
22 cm/8¾"

Bone Instruments

Bone Chisels, and Gouges Osteotomes
Knochenmeißeln, und Gouges Osteotome

Bone ciseaux, et gouges ostéotomes
Cinceles, formones y osteotomos



12



Zielke
23 cm/9"
5.5 mm
9.0 mm

12-1784-05
12-1784-09

Width
Breite
largeur
ancho



mm	12-1784-06	12-1785-06	12-1786-06	12-1787-06	12-1788-06
06	12-1784-06	12-1785-06	12-1786-06	12-1787-06	12-1788-06
08	12-1784-08	12-1785-08	12-1786-08	12-1787-08	12-1788-08
10	12-1784-10	12-1785-10	12-1786-10	12-1787-10	12-1788-10
12	12-1784-12	12-1785-12	12-1786-12	12-1787-12	12-1788-12
15	12-1784-15	12-1785-15	12-1786-15	12-1787-15	12-1788-15
20	12-1784-20	12-1785-20	12-1786-20	12-1787-20	12-1788-20
25	12-1784-25	12-1785-25	12-1786-25	12-1787-25	12-1788-25
30	12-1784-30	12-1785-30	12-1786-30	12-1787-30	12-1788-30

Stille
20 cm/8"

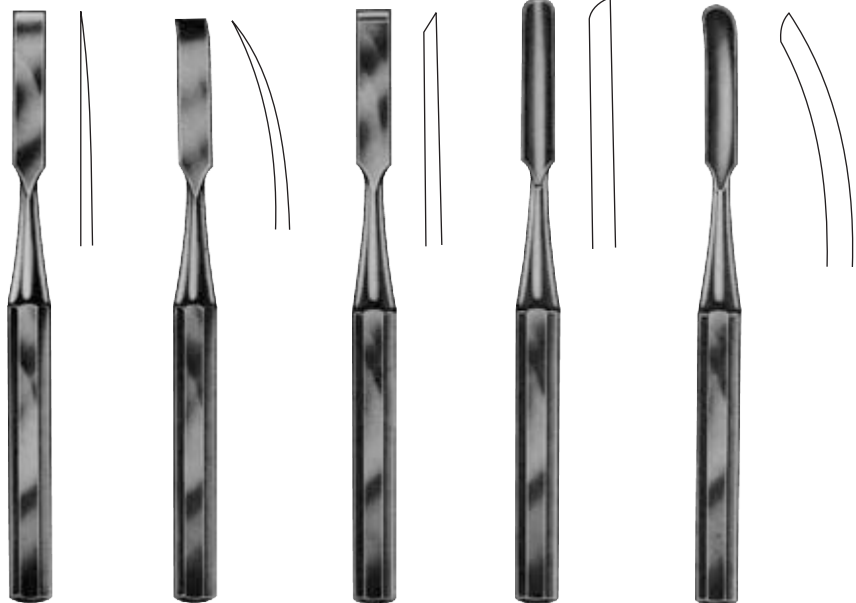

mm	12-1789-06	12-1790-06	12-1791-06	12-1792-06	12-1793-06
06	12-1789-06	12-1790-06	12-1791-06	12-1792-06	12-1793-06
09	12-1789-09	12-1790-09	12-1791-09	12-1792-09	12-1793-09
13	12-1789-13	12-1790-13	12-1791-13	12-1792-13	12-1793-13
16	12-1789-16	12-1790-16	12-1791-16	12-1792-16	12-1793-16
19	12-1789-19	12-1790-19	12-1791-19	12-1792-19	12-1793-19
25	12-1789-25	12-1790-25	12-1791-25	12-1792-25	12-1793-25
32	12-1789-32	12-1790-32	12-1791-32	12-1792-32	12-1793-32

Hibbs
24 cm/9½"

Bone Instruments

Bone Gouges
Knochen Gouges

Gouges os
Gouges hueso



mm **Lexer**
05 12-1794-05
10 12-1794-10
15 12-1794-15

28 cm/11"



Lexer
12-1795-05
12-1795-10
12-1795-15

25 cm/10"



Lexer
12-1796-05
12-1796-10
12-1796-15

25 cm/10"



12-1797-01



12-1797-02



12-1798-03



Cobb
28 cm/11"

12-1799-04

Bone Instruments

Bone Curettes
Scharfe Löffel

Curettes osseuses
Curetas óseas



12

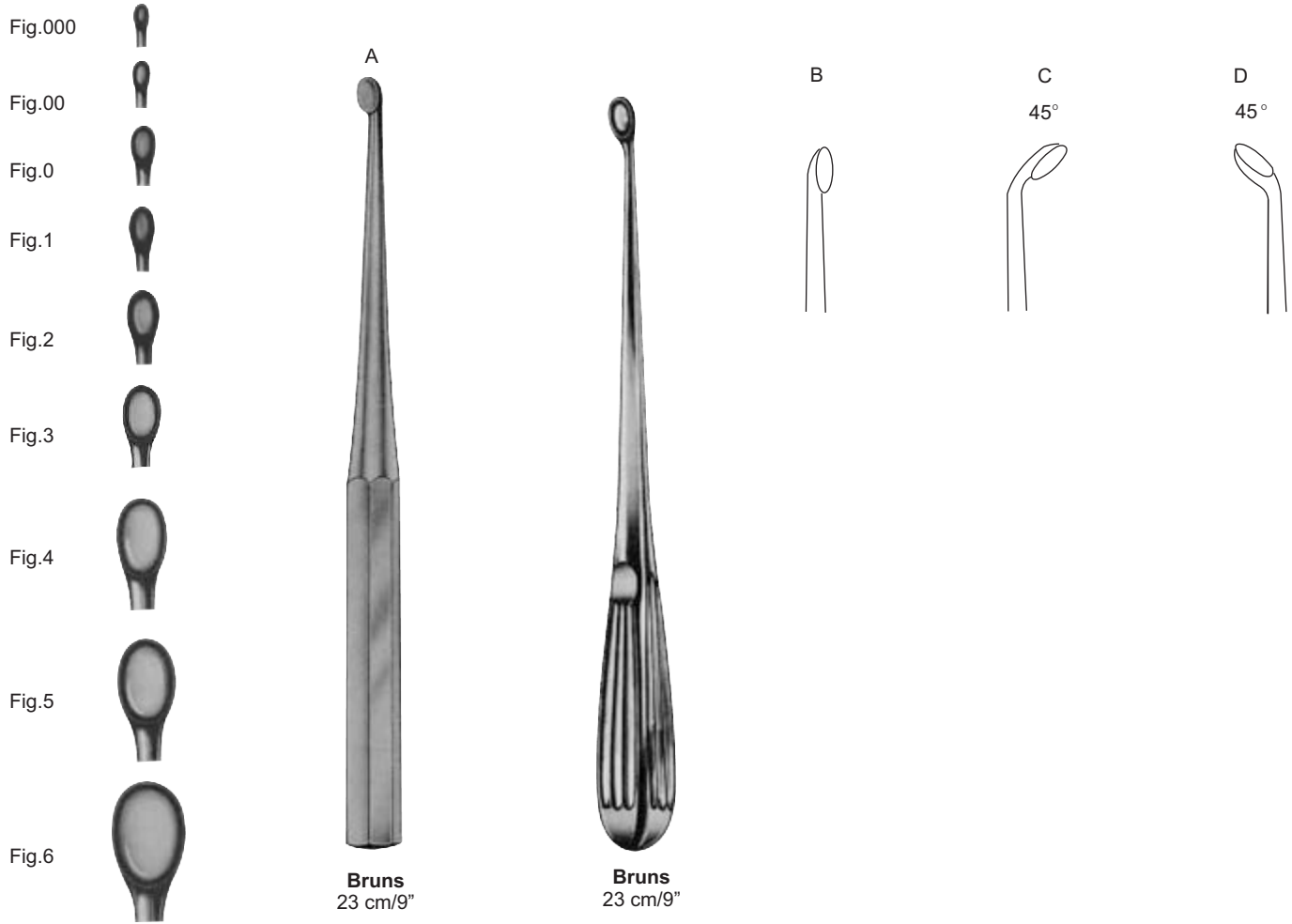

Fig.	A	B	C	D
000	12-1800-30	12-1801-30	12-1802-30	12-1803-30
00	12-1800-20	12-1801-20	12-1802-20	12-1803-20
0	12-1800-10	12-1801-10	12-1802-10	12-1803-10
1	12-1800-01	12-1801-01	12-1802-01	12-1803-01
2	12-1800-02	12-1801-02	12-1802-02	12-1803-02
3	12-1800-03	12-1801-03	12-1802-03	12-1803-03
4	12-1800-04	12-1801-04	12-1802-04	12-1803-04
5	12-1800-05	12-1801-05	12-1802-05	12-1803-05
6	12-1800-06	12-1801-06	12-1802-06	12-1803-06

Bone Instruments

Bone Curettes
Scharfe Löffel

Curettes osseuses
Curetas óseas



Volkman
17 cm/6³/₄"

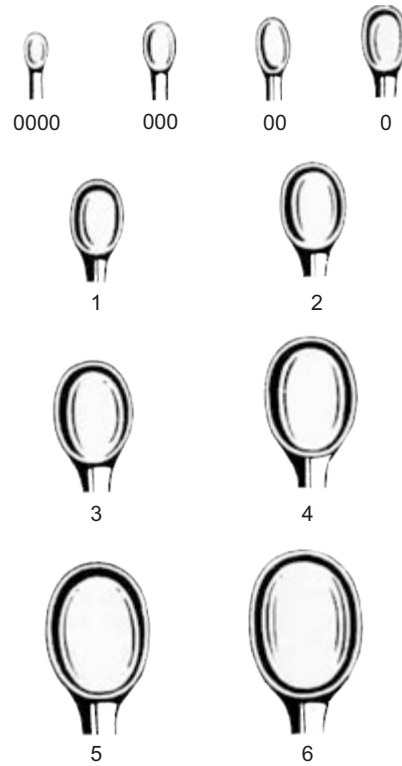

- Fig.
0000 12-1804-40
000 12-1804-30
00 12-1804-20
0 12-1804-10
1 12-1804-01
2 12-1804-02
3 12-1804-03
4 12-1804-04
5 12-1804-05
6 12-1804-06



Volkman
17 cm/6³/₄"

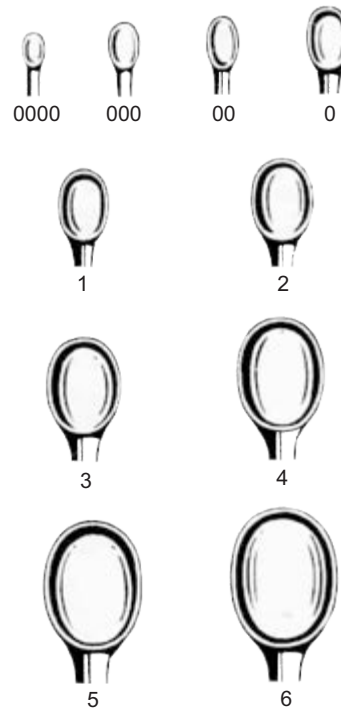

- Fig.
0000 12-1805-40
000 12-1805-30
00 12-1805-20
0 12-1805-10
1 12-1805-01
2 12-1805-02
3 12-1805-03
4 12-1805-04
5 12-1805-05
6 12-1805-06

Bone Instruments

Bone Curettes
Scharfe Löffel

Curettes osseuses
Curetas óseas



12



Bruns
17 cm/6¾"

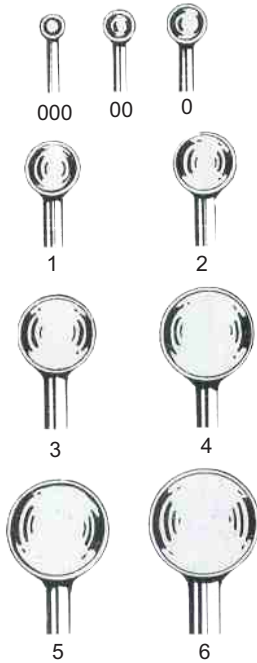

Bruns	Fig.	Spratt
12-1806-30	000	12-1807-30
12-1806-20	00	12-1807-20
12-1806-10	0	12-1807-10
12-1806-01	1	12-1807-01
12-1806-02	2	12-1807-02
12-1806-03	3	12-1807-03
12-1806-04	4	12-1807-04
12-1806-05	5	12-1807-05
12-1806-06	6	12-1807-06



Spratt
16 cm/6¼"

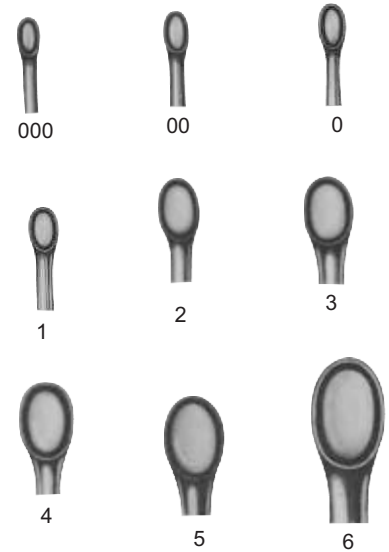

Swedish pattern

mm	Round	Oval
2	12-1808-02	12-1809-03
3	12-1808-03	12-1809-04
4	12-1808-04	12-1809-05
5	12-1808-05	12-1809-06
6	12-1808-06	12-1809-07
7	12-1808-07	12-1809-08
8	12-1808-08	12-1809-10
10	12-1808-10	12-1809-12
12	12-1808-12	12-1809-14
14	12-1808-14	22cm/8 "
	17cm/6¾"	½

Bone Instruments

Bone Curettes
Scharfe Löffel

Curettes osseuses
Curetas óseas

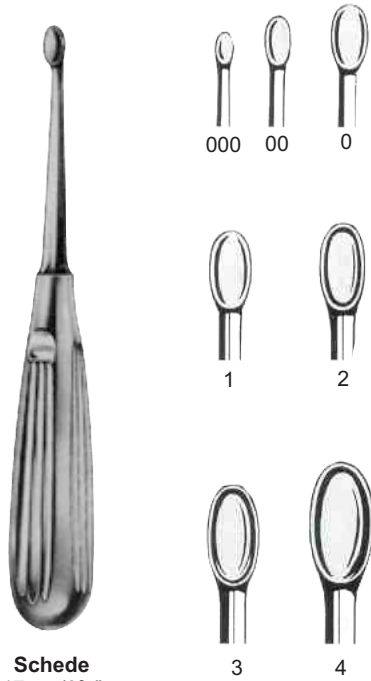

Schede
17 cm/6³/₄"

Fig.	
000	12-1810-30
00	12-1810-20
0	12-1810-10
1	12-1810-01
2	12-1810-02
3	12-1810-03
4	12-1810-04

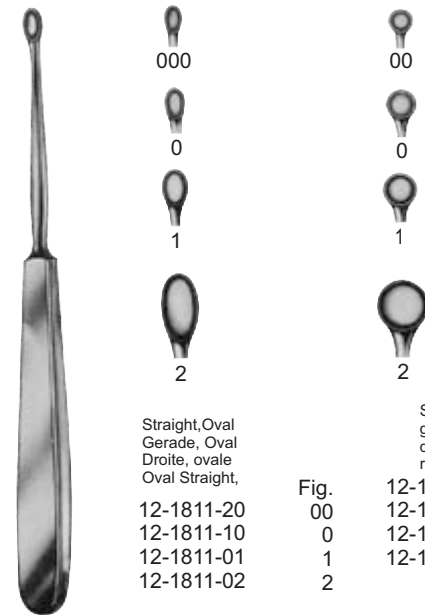

Williger
17.5 cm/7"

	Straight, Oval
	Gerade, Oval
	Droite, ovale
	Oval Straight.
12-1811-20	
12-1811-10	
12-1811-01	
12-1811-02	

	Straight
	gerade
	droit
	recto
Fig.	
00	12-1812-20
0	12-1812-10
1	12-1812-01
2	12-1812-02



12-1813-01

Uffenorde
17 cm/6³/₄"



12-1814-02

Bone Instruments

Bone Curettes
Scharfe Löffel

Curettes osseuses
Curetas óseas



12

Fig. 0
12-1815-10

Fig. 1
12-1815-01

Fig. 2
12-1815-02

Fig. 3
12-1815-03

Fig. 1
12-1816-01

Fig. 2
12-1816-02

Fig. 3
12-1816-03

Fig. 4
12-1816-04

Fig. 5
12-1816-05

Fig. 6
12-1816-06

Fig. 0000
12-1817-40

Fig. 000
12-1817-30

Fig. 00
12-1817-20

Fig. 0
12-1817-10

Fig.00
12-1818-20

Fig.0
12-1818-10

Fig. 1
12-1818-01

Fig. 2
12-1818-02



Volkman
27 cm/10½"



Simon
24 cm/9½"



Simon
24 cm/9½"



Daubenspeck
20 cm/8"

Bone Instruments

Bone Curettes
Scharfe Löffel

Curettes osseuses
Curetas óseas

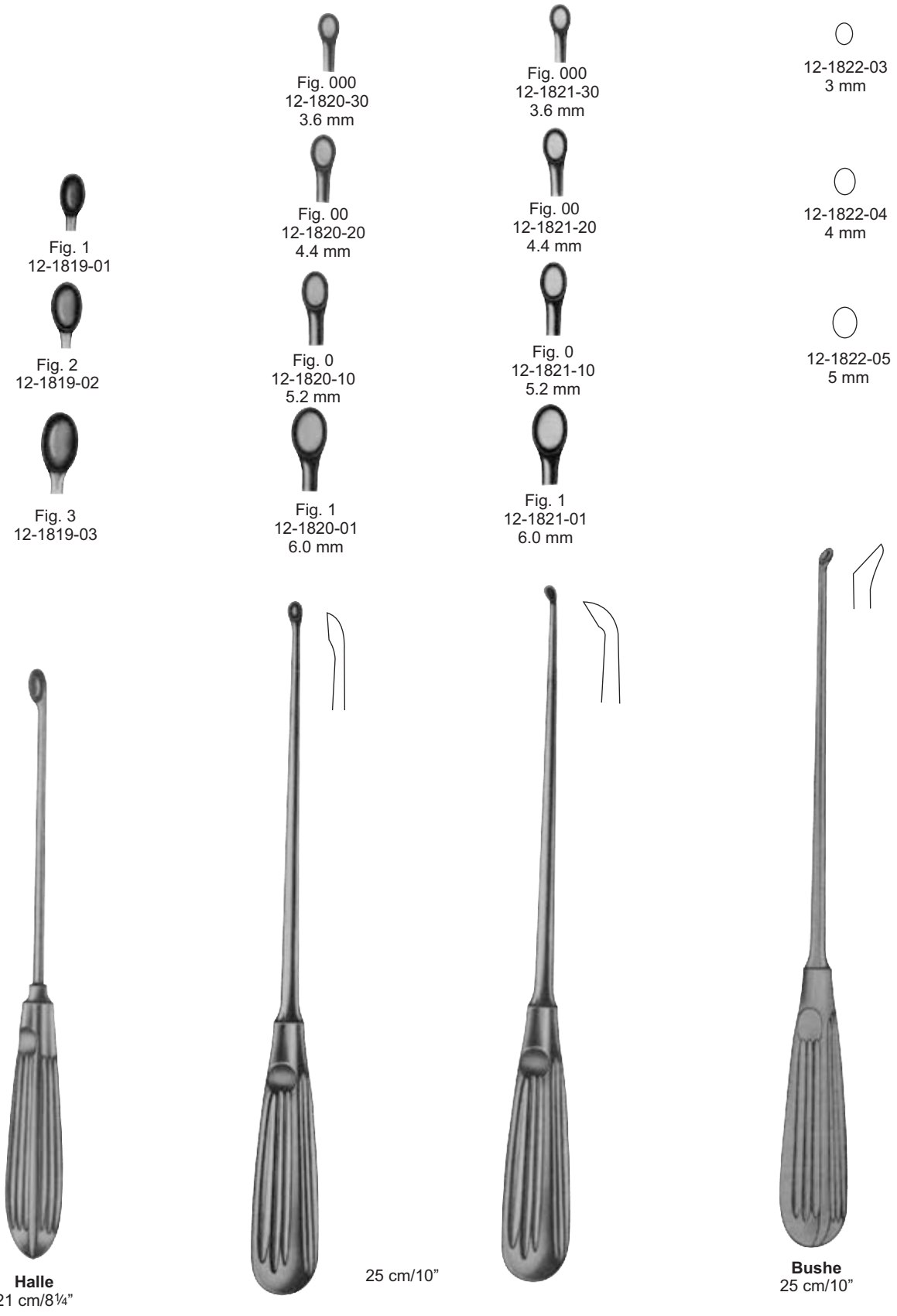

Bone Instruments

Bone Curettes
Scharfe Löffel

Curettes osseuses
Curetas óseas



12



12-1823-21
21 cm/8 1/4"



Epstein



Spinal



Spinal

Fig.

000	12-1824-30	12-1825-30	12-1826-30
00	12-1824-20	12-1825-20	12-1826-20
0	12-1824-10	12-1825-10	12-1826-10
1	12-1824-01	12-1825-01	12-1826-01
2	12-1824-02	12-1825-02	12-1826-02
3	12-1824-03	12-1825-03	12-1826-03
4	12-1824-04	12-1825-04	12-1826-04
5	12-1824-05	12-1825-05	12-1826-05
6	12-1824-06	12-1825-06	12-1826-06
	20 cm/8"	20 cm/8"	20 cm/8"



Bone Instruments

Bone Files and Rasps
Knochen-Feilen und Raspeln

Fichiers os et râpes
Archivos de hueso y Escofinas

12



Putti
12-1836-30
30 cm/12"



Putti
12-1837-27
27 cm/10½"



12-1838-25
25 cm/10"



12-1839-24
24 cm/9½"



12-1840-22
22 cm/8¾"



Bone Instruments

Bone Curettes
Scharfe Löffel

Curettes osseuses
Curetas óseas



12

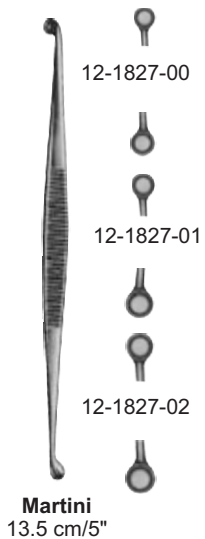

Martini
13.5 cm/5"



Jansen
12-1828-15
15 cm/6"



Length	Volkman	
	Oval/Oval	Oval/Round
cm in		
13 5"	12-1829-13	12-1830-13
14 5½"	12-1829-14	
16 6¼"		12-1830-16
17 6¾"	12-1829-17	
20 8"	12-1829-20	12-1830-20



Janson
12-1831-15
15 cm/6"



Barth
12-1832-18
18 cm/7"



Jansen
12-1833-16
16 cm/6¼"



Williger
13.5 cm/5"



Jacobson
12-1835-13
13 cm/5"

Bone Instruments

Periosteal Raspatories
periostale Raspatories

périostée Couronne Instruments
Raspatories periostio



Farabeuf-Collin
12-1841-15
15.5 cm/6"
11 mm



Farabeuf-Collin
12-1842-15
15.5 cm/6"
11 mm



Farabeuf
12-1843-15
15 cm/6"



Farabeuf
12-1844-15
15 cm/6"

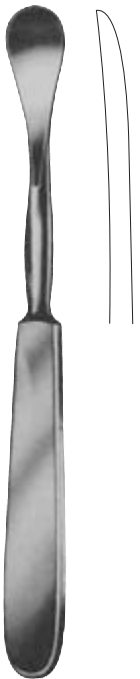

Sedillot
12-1845-18
18 cm/7"
18 mm



Sedillot
12-1846-21
21 cm/8¹/₄"
15 mm

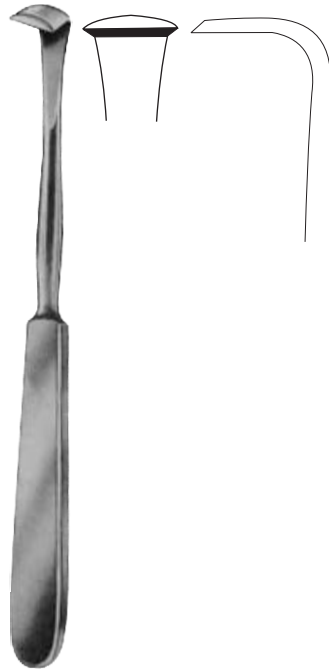

Langenbeck
12-1847-18
18 cm/7"

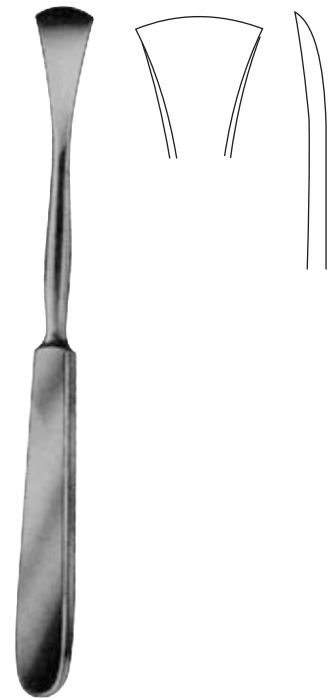

Langenbeck
12-1848-19
19 cm/7¹/₂"

Bone Instruments

Periosteal Raspatories
periostale Raspatories

périostée Couronne Instruments
Raspatories periostio



12



Alexander
12-1849-20
20 cm/8"



Lambotte
21 cm/8¼"

	mm
12-1850-05	05
12-1850-10	10
12-1850-15	15
12-1850-20	20
12-1850-25	25



Schneider
12-1851-17
17.5 cm/7"
13 mm



Schneider-Sauerbruch
12-1852-19
19 cm/7½"
13 mm



Jansen
12-1853-16
16.5 cm/6½"
15 mm



Seldin
12-1854-19
19 cm/7½"



Davidson-Alexander
12-1855-29
29 cm/11½"

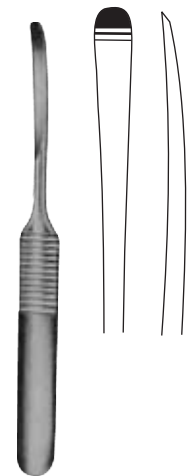

Williger
12-1856-13
13 cm/5"

Bone Instruments

Periosteal Raspatories
periostale Raspatories

périostée Couronne Instruments
Raspatories periostio

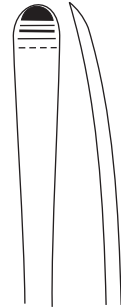

Williger
12-1857-16
16 cm/6¼"



König
12-1858-15
15.5 cm/6"
5 mm



12-1859-06
6 mm

17 cm/6¾"

12-1860-08
8 mm



12-1861-01

12-1861-02



12-1861-03

12-1861-04

Adson
17 cm/6¾"

Bone Instruments

Periosteal Raspatories
periostale Raspatories

périostée Couronne Instruments
Raspatories periostio



12



Matson
12-1863-22
22 cm/8¾"



Overholt
12-1864-29
29.5 cm/11½"



Overholt
12-1865-29
29.5 cm/11½"



Overholt
12-1866-28
28.5 cm/11¼"

Bone Instruments

Periosteal Raspatories
periostale Raspatories

périostée Couronne Instruments
Raspatories periostio



Cobb
24 cm/9½"



12-1867-04
4 mm

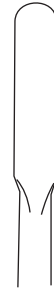

12-1867-06
6 mm



12-1867-08
8 mm



12-1867-10
10 mm



12-1867-13
13 mm

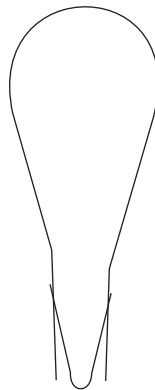

12-1867-19
19 mm

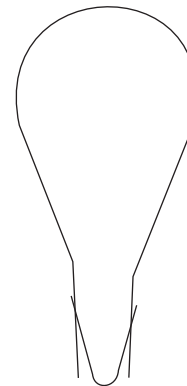

12-1867-25
25 mm

Bone Instruments

Periosteal Raspatories
periostale Raspatories

périostée Couronne Instruments
Raspatories periostio



12



Doyen
17 cm/6¾"

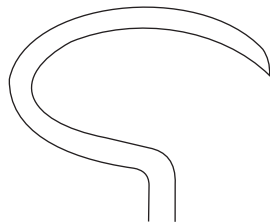

12-1868-01

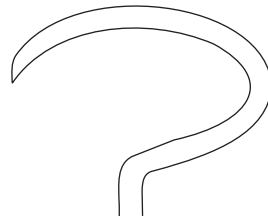

12-1868-02

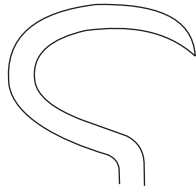

12-1869-01

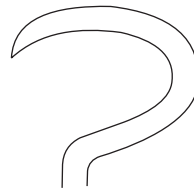

12-1869-02



12-1870-01



Doyen
24 cm/9½"



12-1871-02



Semb



12-1872-01
19.5 cm/7½"
12 mm



12-1872-02
19.5 cm/7½"
12 mm



12-1872-03
19.5 cm/7½"
12 mm



12-1872-04
22 cm/8¾"
13 mm



12-1872-05
21.5 cm/8½"
13 mm



12-1872-06
22 cm/8½"
15 mm



12-1872-07
22 cm/8½"
15 mm

Bone Instruments

Periosteal Raspatories
periostale Raspatories

périostée Couronne Instruments
Raspatories periostio



12-1873-05
18.5 cm/7¼"
13 mm



12-1874-06
19.5 cm/7¾"
14 mm

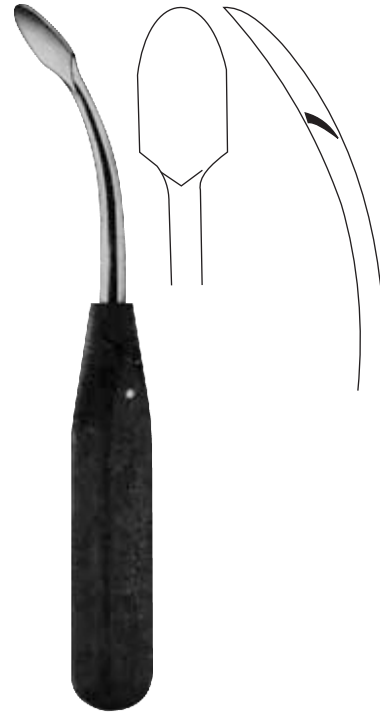

12-1875-07
18.5 cm/7¼"
14 mm



12-1876-08
20 cm/8 "
20 mm



12-1877-01
19 cm/7½"
6 mm



12-1878-02
18.5 cm/7¼"
3 mm



12-1879-03
18.5 cm/7¼"
6 mm



12-1880-04
18.5 cm/7¼"
6 mm

Bone Instruments

Periosteal Raspatories
periostale Raspatories

périostée Couronne Instruments
Raspatories periostio



12



12-1881-20
27.5 cm/10³/₄"
20 mm



Wagner
8 mm 12-1882-08 33 cm/13"
17 mm 12-1882-17 33 cm/13"



Cobb
10 mm 12-1883-10 25 cm/10"
13 mm 12-1883-13 25 cm/10"
19 mm 12-1883-19 25 cm/10"
25 mm 12-1883-25 25 cm/10"



Cobb
10 mm 12-1884-10 28 cm/11"
13 mm 12-1884-13 28 cm/11"
19 mm 12-1884-19 28 cm/11"

Bone Instruments

Elevators
Aufzüge

Ascenseurs
Ascensores



Langenbeck
12-1885-20
20 cm/8"
8 mm

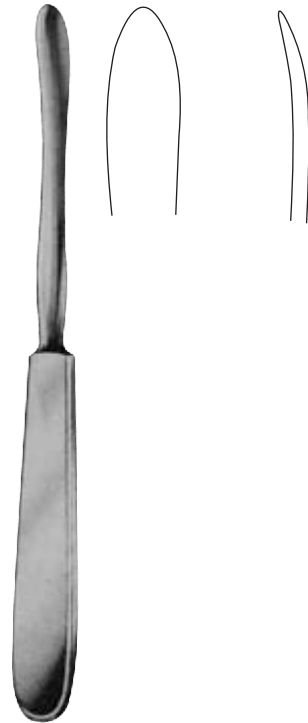

Langenbeck
12-1886-20
20 cm/8"
10 mm

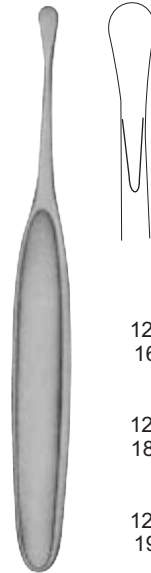

12-1887-07
16 cm/6¼"
7 mm

12-1887-15
18.5 cm/7¼"
15 mm

12-1887-20
19 cm/7½"
20 mm



Yankauer
12-1888-18
18 cm/7"



Langenbeck
12-1889-23
23 cm/9"
11 mm

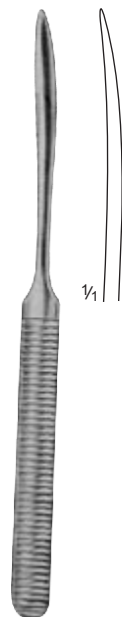

Williger
12-1890-16
16 cm/6¼"

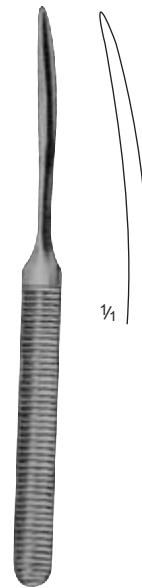

Williger
12-1891-17
17 cm/6¾"

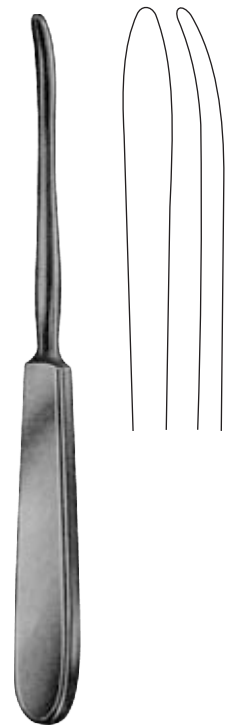

Quervain
12-1892-20
20 cm/8"

Bone Instruments

Elevators
Aufzüge

Ascenseurs
Ascensores



12

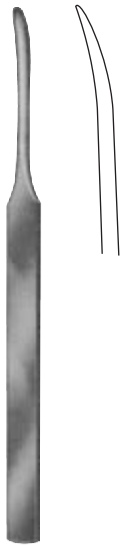

König
12-1893-15
15 cm/6"
4.5 mm

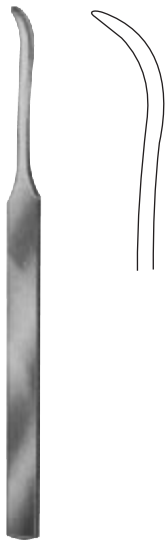

König
12-1894-15
15 cm/6"
4.5 mm

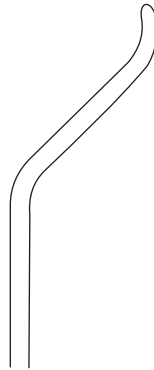

Hohman-Willinger
12-1895-16
16 cm/6¼"



6 mm

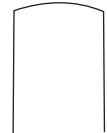

12 mm

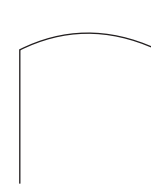

19 mm

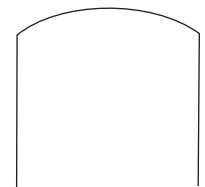

25 mm

Key

6 mm	12-1896-06	19 cm/7½"
12 mm	12-1896-12	19 cm/7½"
19 mm	12-1896-19	19 cm/7½"
25 mm	12-1896-25	19 cm/7½"

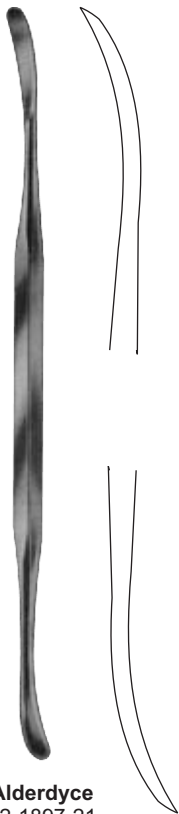

Alderdyce
12-1897-21
21 cm/8¼"



McDonald
12-1898-19
19 cm/7½"



Watson-Cheyne
12-1899-19
17.5 cm/7"

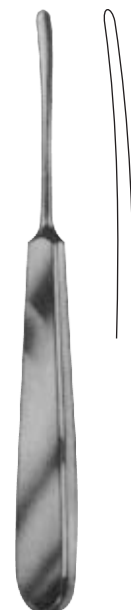

Sebileau
12-1900-17
17 cm/6¾"

Bone Instruments

Bone Levers
Knochen-Hebel

Leviers os
Las palancas de hueso

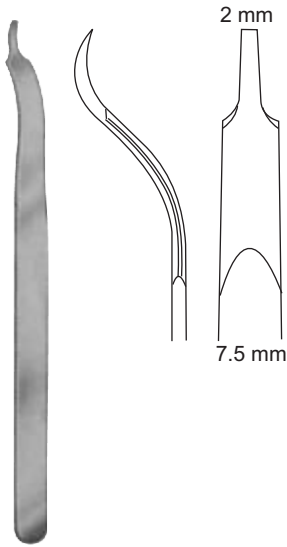

Buck-Gramcko
12-1901-15
15 cm/6"



Hohmann mini
12-1902-14
14 cm/5½"
2.8 mm

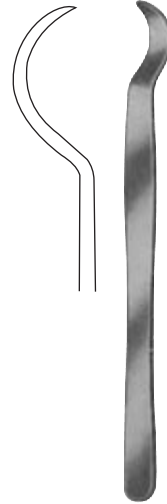

12-1903-15
15 cm/6"
5 mm

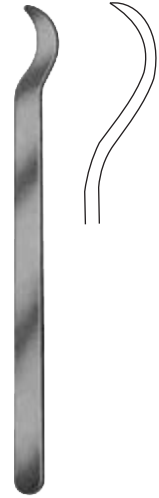

12-1904-15
15 cm/6"
7 mm

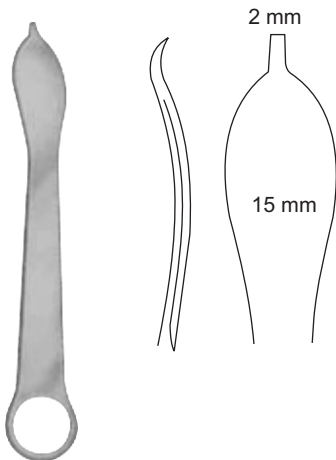

12-1905-12
12.5 cm/5"



Mini-Hohmann
16 cm/6¼"



12-1906-06
6 mm

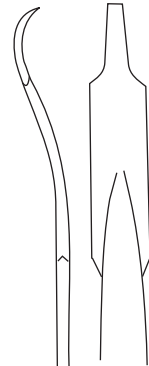

12-1906-08
8 mm

Bone Instruments

Bone Levers
Knochen-Hebel

Leviers os
Las palancas de hueso



12

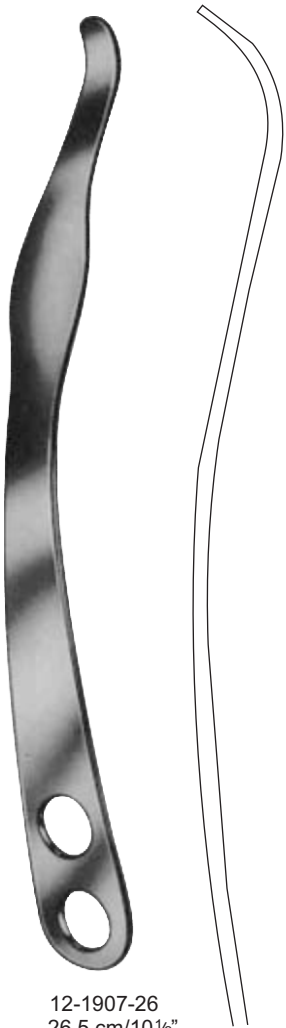

12-1907-26
26.5 cm/10½"
24 mm

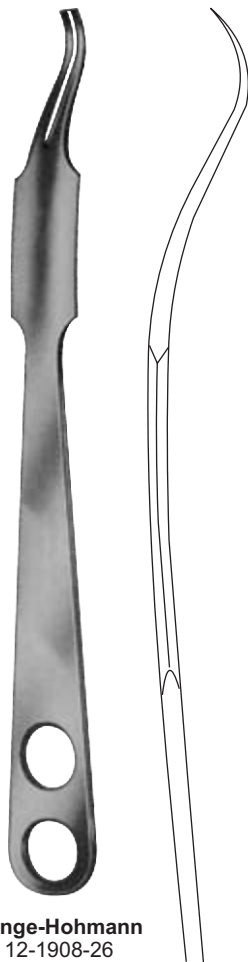

Lange-Hohmann
12-1908-26
26 cm/10¼"
22 mm

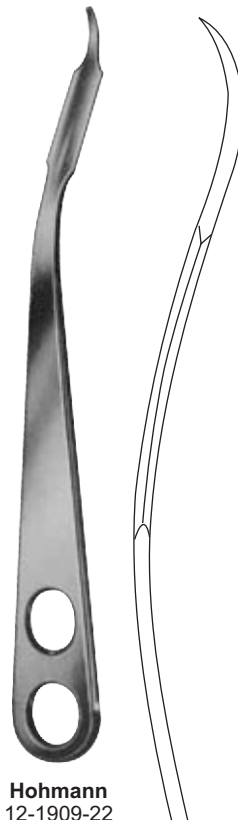

Hohmann
12-1909-22
22 cm/8¾"
8 mm

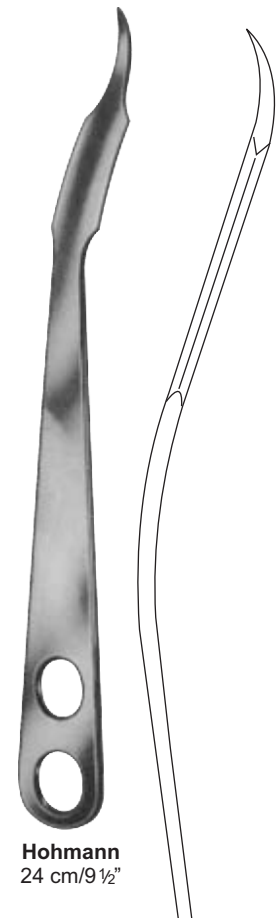

Hohmann
24 cm/9½"

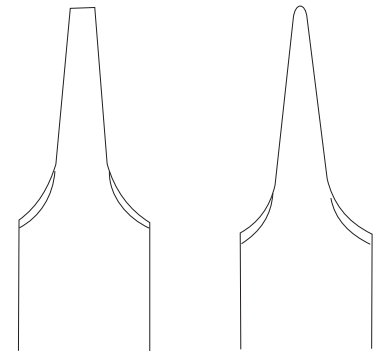

12-1910-17 17 mm
12-1910-18 18 mm

12-1911-17 17 mm

Bone Instruments

Bone Levers
Knochen-Hebel

Leviers os
Las palancas de hueso



Hohmann
12-1912-26
26 cm/10¼"
22 mm

Hohmann
12-1913-28
28 cm/11"
33 mm

Hohmann
12-1914-24
24 cm/9½"
43 mm

Hohmann
12-1915-24
24.5 cm/9¾"
43 mm

Hohmann
12-1916-24
24 cm/9½"
70 mm

Hohmann
12-1917-22
22 cm/8¾"
18 mm

Bone Instruments

Bone Levers
Knochen-Hebel

Leviers os
Las palancas de hueso

12



Lange-Hohmann modif
30 mm 12-1918-26 26.5 cm/10 1/2"
33 mm 12-1918-29 29.0 cm/11 1/2"



Hohmann-Aldinger
12-1919-27
27 cm/10 1/2"

24 mm

18 mm



**Schumacher
(Wagner)**
12-1920-34
34.5 cm/13 1/2"

37 mm

18 mm



Schumacher
12-1921-29
29 cm/11 1/2"

35 mm

Bone Instruments

Bone Levers
Knochen-Hebel

Leviers os
Las palancas de hueso

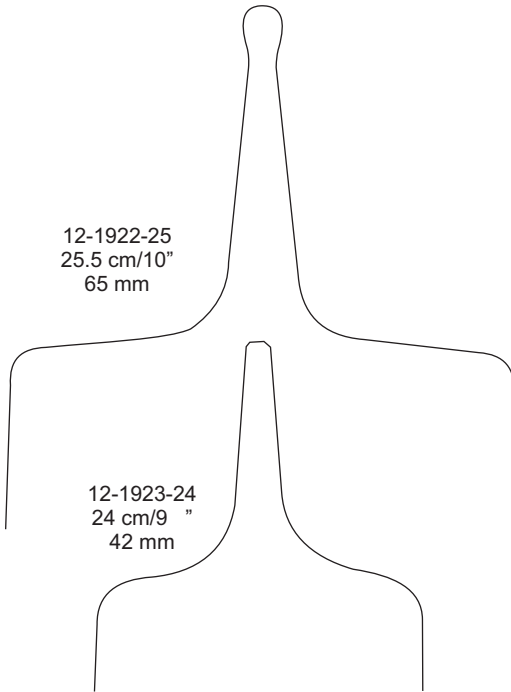

Verbrugge-Muller



Lane Trethowan
12-1927-21
21.5 cm/8½"



Lane
12-1925-25
25.5 cm/10"



Bristow
12-1926-23
23 cm/9"

Bone Instruments

Bone Levers
Knochen-Hebel

Leviers os
Las palancas de hueso



12



Blount
12-1928-26
26 cm/10¼"



Blount
12-1929-26
26 cm/10¼"



Bennett 12-1930-43 43 mm
24 cm/9½" 12-1930-60 60 mm



Murphy-Lane
12-1931-32
32 cm/12½"



Chandler

Length Länge longueur longitud	Width Breite largeur ancho	
18 cm	13 mm	12-1932-13
20 cm	19 mm	12-1932-19
23 cm	25 mm	12-1932-23
25 cm	30 mm	12-1932-30

Bone Instruments

Meniscus and Spinal Retractors
Meniskus-und Spinal Retraktoren

Rétracteurs méniscales et de la moelle
Los retractoros de menisco y la columna vertebral



Smillie
14 cm/5½"

12-1933-01
32x19 mm

12-1933-02
48x19 mm

12-1933-03
57x19 mm



12-1933-04
52x13 mm



12-1933-05
12x13 mm

Spinal retractors
Spinal Retraktoren
écarteurs rachidiens
retractoros de la columna vertebral



12-1934-01
75x30 mm

12-1934-02
100x30 mm

Taylor
17 cm/6½"

Meniscus retractors
Meniskus Retraktoren
rétracteurs de ménisque
retractoros de menisco



12-1935-21
21.5 cm/8½"



Blount
12-1936-17
17.5 cm/7"

Bone Instruments

Meniscotomy Knives
Meniscotomy Messer

Couteaux Meniscotomy
Cuchillos Meniscotomy



12



Smillie
12-1937-17
17 cm/6¾"



Smillie
12-1938-17
17 cm/6¾"



Smillie
12-1939-17
17 cm/6¾"



Salenius
12-1940-22
22 cm/8¾"



Salenius
12-1941-22
22 cm/8¾"

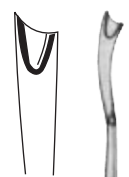
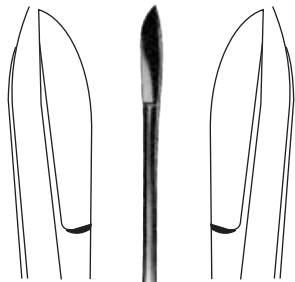

12-1942-17
17.5 cm/7"



Neff
21.5 cm/8½"



Canad-Modell
12-1943-01
20 cm/8"



12-1944-02



Bircher
12-1945-20
20.5 cm/8"

Bone Instruments

Bone Holding Forceps
Knochenhaltezaugen

Os Davier
Bone Pinzas



Dingmann Modif
12-1946-19
19 cm/7½"

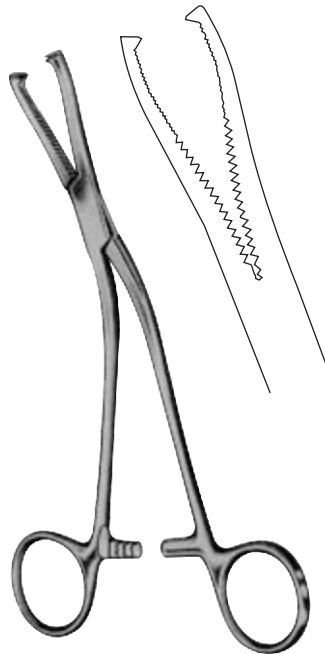

Dingmann
12-1947-19
19cm/7½"



Neff ¼
12-1948-21
21cm/8 "

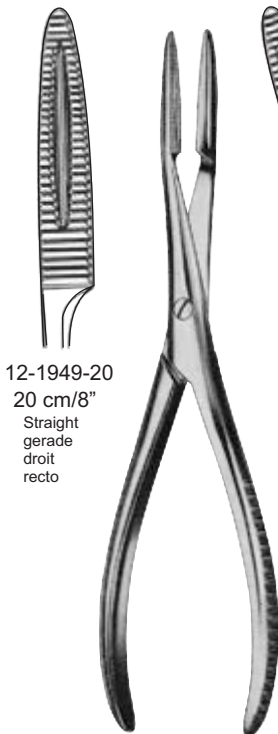

12-1949-20
20 cm/8"
Straight
gerade
droit
recto



12-1950-20
20 cm/8"
Curved on Falt
Gebogene am Falt
Courbé sur Falt
Curva de Falt



Van Buren
12-1951-23
23 cm/9"

Bone Instruments

Bone Holding Forceps
Knochenhaltezangen

Os Davier
Bone Pinzas



12

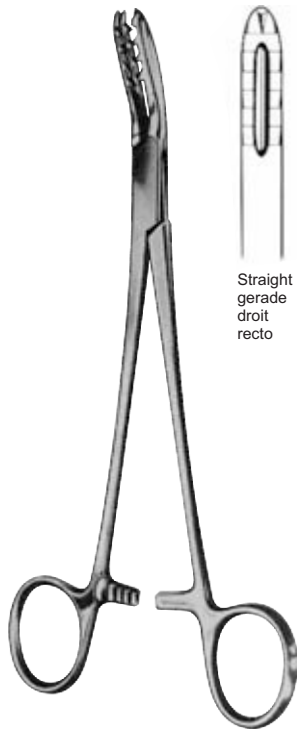

Straight
gerade
droit
recto

Bircher-Ganske
12-1952-20
20 cm/8"



Bircher-Ganske
12-1953-20
20 cm/8"



Martin
12-1954-19
19 cm/7½"



Lewin
12-1955-17
17.5 cm/7"



Fergusson
12-1956-21
21 cm/8¼"



Langenbeck
12-1957-21
21 cm/8¼"

Bone Instruments

Bone Holding Forceps
Knochenhaltezangen

Os Davier
Bone Pinzas



Without Ratchet
ohne Ratchet
sans cliquet
Sin Ratchet

12-1958-17
12-1958-21

Kern

cm	in
17	6 ³ / ₄ "
21	8 ¹ / ₄ "

With Ratchet
mit Ratchet
avec Ratchet
Con Ratchet

12-1959-17
12-1959-21

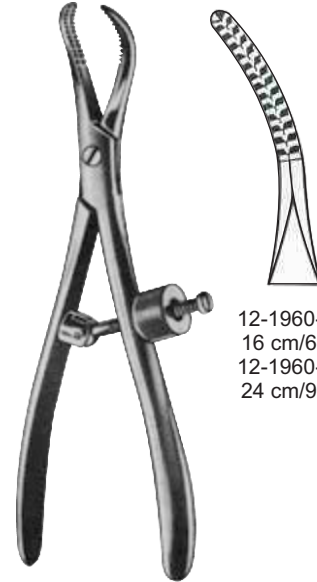

12-1960-16
16 cm/6¹/₄"
12-1960-24
24 cm/9¹/₂"



Ulrich
12-1961-18 18 cm/7"
12-1961-23 23 cm/9"
12-1961-25 25 cm/10"
12-1961-28 28 cm/11"



Ulrich
12-1962-18 18 cm/7"
12-1962-23 23 cm/9"
12-1962-25 25 cm/10"
12-1962-28 28 cm/11"



Hey Groves
12-1963-21 20 cm/8"
12-1963-27 25 cm/10"
12-1963-30 30 cm/12"

Bone Instruments

Bone Holding Forceps
Knochenhaltezangen

Os Davier
Bone Pinzas



12



Semb
12-1964-19
19 cm/7½"



Semb
12-1965-19
19 cm/7½"

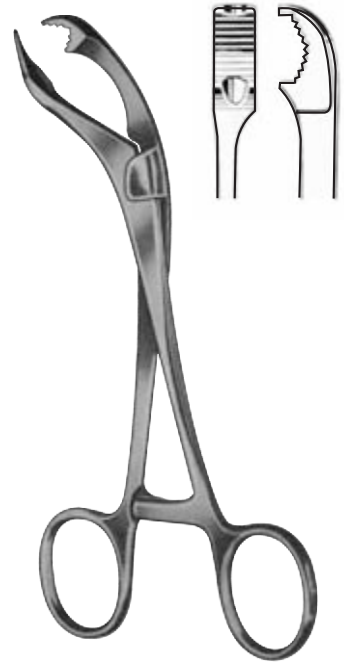

Verbrugge
12-1966-17
17.5 cm/7"



Verbrugge

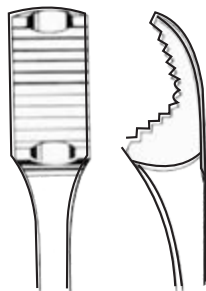

12-1967-25
25 cm/10"

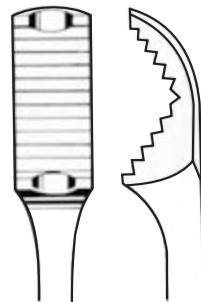

12-1968-26
26 cm/10¼"
Verbrugge

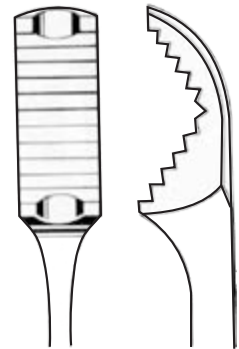

12-1969-27
27 cm/10½"

Bone Instruments

Bone Holding Forceps
Knochenhaltezaugen

Os Davier
Bone Pinzas



**Self
Centring**

12-1970-15 15 cm/6"
12-1970-19 19 cm/7½"
12-1970-24 24 cm/9½"
12-1970-26 26 cm/10¼"
12-1970-28 28 cm/11"



Handles Detachable
Griffe Abnehmbare
poignées détachables
Maneja desmontable

Percy
12-1971-30

Adjustable
einstellbar
réglable
ajustable



Lambotte

12-1972-22 22 cm/8¾"
12-1972-27 27 cm/10½"
12-1972-30 30 cm/12"



Farabeuf

12-1973-23 23 cm/9"
12-1973-26 26 cm/10¼"



Lambotte

12-1974-22 22.5 cm/9"
12-1974-25 25.5 cm/10½"
12-1974-33 33 cm/13½"

Bone Instruments

Bone Holding Forceps
Knochenhaltezaugen

Os Davier
Bone Pinzas



12



Farabeuf-Lambotte
12-1975-26
26 cm/10¼"



Lambotte
12-1976-19 19 cm/7½"
12-1976-23 23 cm/9"
12-1976-26 26 cm/10¼"

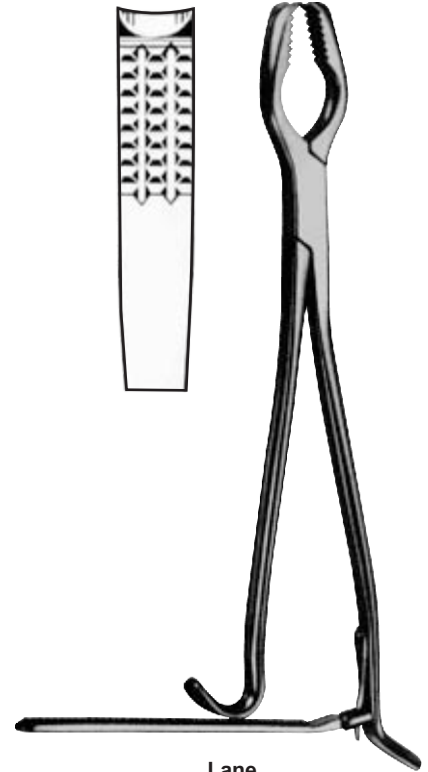

	Lane	
	cm in	
12-1977-33	33 13"	12-1978-33
12-1977-45	45 17¾"	12-1978-45
Without Ratchet ohne Ratchet sans cliquet Sin Ratchet		With Ratchet mit Ratchet avec Ratchet Con Ratchet



12-1979-14
14.5 cm/5¾"



12-1980-12
12 cm/4¾"



12-1981-13
13.5 cm/5¼"



Bone Instruments

Os Rongeur Forceps
Knochen Hohlmeißelzange

Os Rongeur Forceps
Pinzas gubia ósea

12



Clovis Vincent
12-1989-21 21 cm/8 1/4"
12-1989-26 26 cm/10 1/4"

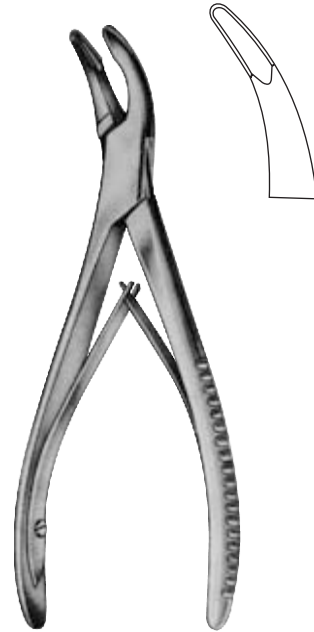

Bane-Hartmann
12-1990-17
17.5 cm/7"



Mini-Friedmann
12-1991-12
12.5 cm/5"



Friedmann
12-1992-14
14 cm/5 1/2"

Bone Instruments

Bone Holding Forceps and Bone Holding Clamps
Knochenhaltezange and Bone Halteklammern

Os Davier et os Pinças de Soberella
Hueso y huesos Pinzas abrazaderas que sujetan

12



12-1982-20
20 cm/8"

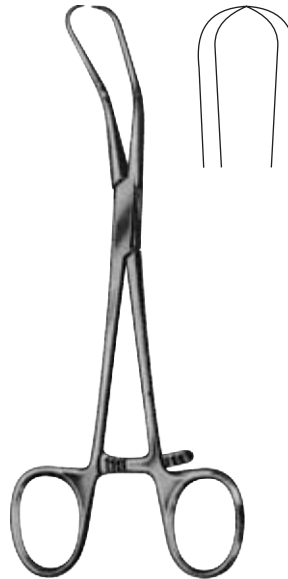

12-1983-17
17 cm/6¾"



12-1984-17
17.5 cm/7"

Traction Bar
Traktion Bar
barre de traction
barra de tracción



Lowman-Hoglund
12-1985-19
19 cm/7½"



Lowman
12-1986-18 18 cm/7"
12-1986-20 20 cm/8"
12-1986-22 22 cm/8¾"



Lowman
12-1987-12
12 cm/4¾"

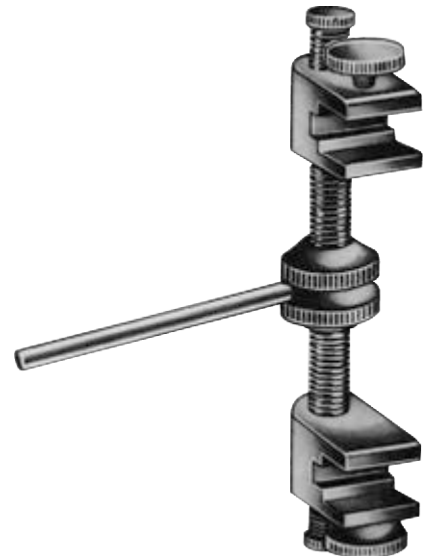

Gerster
12-1988-18
12-1988-50

Bone Instruments

Bone Rongeur Forceps
Knochen Hohlmeißelzange

Os Rongeur Forceps
Pinzas gubia ósea



12-1993-15

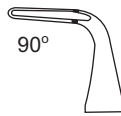

12-1993-90

Friedmann-Delicate
15 cm/6"

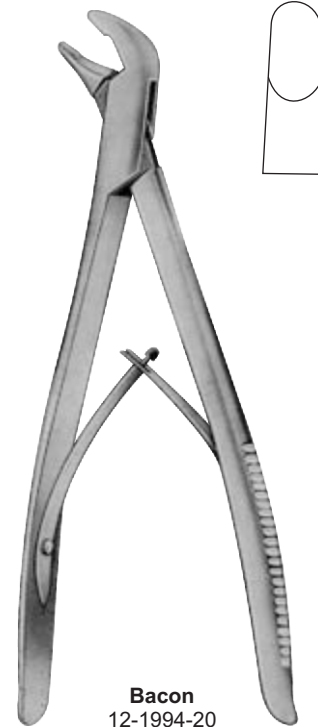

Bacon
12-1994-20
20 cm/8"



Hartmann
12-1995-18
18.5 cm/7¼"



Cleveland
12-1996-14 14 cm/5½"
12-1996-17 17 cm/6¾"



Olivecrona
12-1997-20
20 cm/8"

Bone Instruments

Bone Rongeur Forceps
Knochen Hohlmeißelzange

Os Rongeur Forceps
Pinzas gubia ósea



12

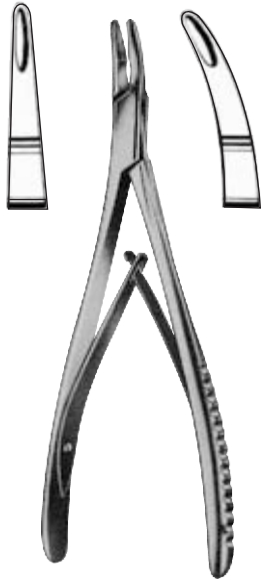

Lempert

12-1998-16	cm	in	12-1999-16
12-1998-19	16	6¼"	12-1999-19
	19	7½"	
Straight			Curved
gerade			Gebogene
droit			courbé
recto			Curvo



Beyer

12-2000-18
18 cm/7"



Mead

16.5 cm/6½"



Blumenthal
15.5 cm/6"



12-2003-15



12-2004-15



12-2005-15



Hakansson
12-2006-15
15.5 cm/6"



Jansen
18 cm/7"



12-2007-17



12-2008-17

Bone Instruments

Bone Rongeur Forceps
Knochen Hohlmeißelzange

Os Rongeur Forceps
Pinzas gubia ósea



12-2009-22

Straight
gerade
droit
recto



12-2010-22

Curved
Gebogene
courbé
Curvo

Stille-Luer
22 cm/8¾"



12-2011-27



12-2012-27

Stille-Luer
27 cm/10½"



Semb
12-2013-23
23 cm/9"

Bone Instruments

Bone Rongeur Forceps
Knochen Hohlmeißelzange

Os Rongeur Forceps
Pinzas gubia ósea



12



Jansen
12-2014-18
18 cm/7"

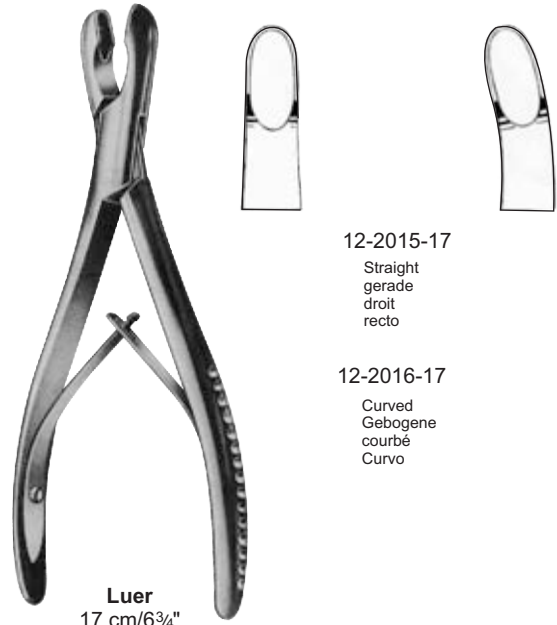

Luer
17 cm/6¾"

12-2015-17
Straight
gerade
droit
recto

12-2016-17
Curved
Gebogene
courbé
Curvo



Luer
18.5 cm/7¼"
12-2017-15

Heavy Pattern
schwere Pattern
modèle lourd
patrón pesado



Luer
15 cm/6"



12-2018-15



12-2019-15



12-2020-15



Adson
20 cm/8"

12-2021-20

Bone Instruments

Bone Rongeur Forceps
Knochen Hohlmeißelzange

Os Rongeur Forceps
Pinzas gubia ósea



Bohler
15cm/6"



12-2022-15



12-2023-15



Kleinert-Kutz
15cm/6"

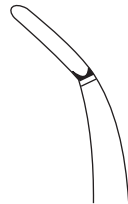

12-2024-15
2mm



12-2025-15
3mm



**Beyer
Zaufal-Jansen**
18 cm/7"



Zaufal-Jansen
12-2026-18

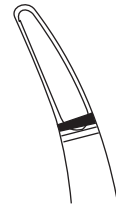

Beyer
12-2027-18



Mayfield
12-2028-17
17 cm/6 3/4"



Ruskin
12-2029-18
18 cm/7"

Straight
gerade
droit
recto

12-2030-18
18 cm/7"
12-2030-23
23 cm/9"

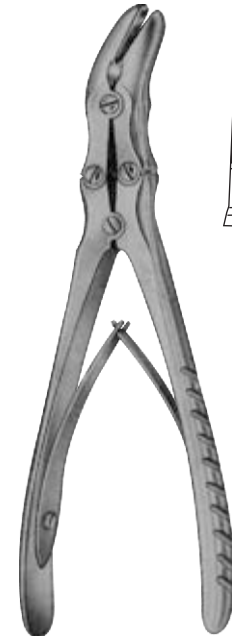

Ruskin



Straight
gerade
droit
recto

12-2031-18
18 cm/7"
12-2031-23
23 cm/9"

Bone Instruments

Bone Rongeur Forceps
Knochen Hohlmeißelzange

Os Rongeur Forceps
Pinzas gubia ósea



12



Marquardt
12-2032-20
20 cm/8"



12-2034-03
3 mm



12-2034-04
4 mm



12-2034-05
5 mm



12-2035-03
3 mm



12-2035-04
4 mm



12-2035-05
5 mm



Rottgen-Ruskin
12-2033-24
24 cm/9½"



Smith-Petersen
24 cm/9½"

Bone Instruments

Bone Rongeur Forceps
Knochen Hohlmeißelzange

Os Rongeur Forceps
Pinzas gubia ósea



Stille-Ruskin
12-2036-23
23 cm/9"



Echlin
23 cm/9"

12-2037-02
2 mm

12-2037-03
3 mm

12-2037-04
4 mm



Leksell
23 cm/9"



12-2038-03
3 mm

12-2038-04
4 mm

12-2038-06
6 mm

12-2038-08
8 mm



Frykholm
12-2039-23
23 cm/9"



Stille
12-2040-23
23 cm/9"

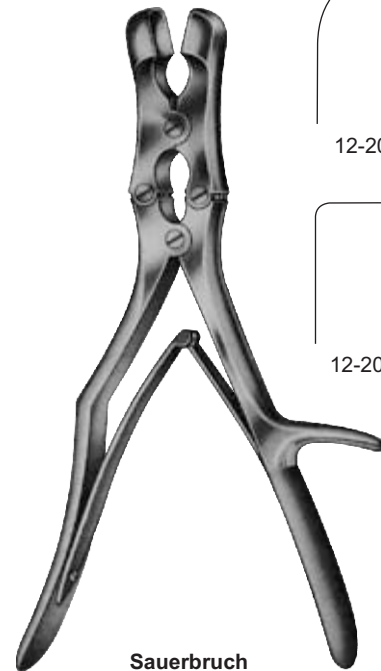

Sauerbruch
30 cm/12"

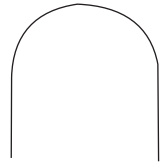

12-2041-30

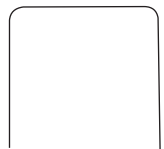

12-2042-30

Bone Instruments

Bone Cutting Forceps
Knochensplitterzangen

Pince de coupe d'os
Pince de coupe d'os...



12

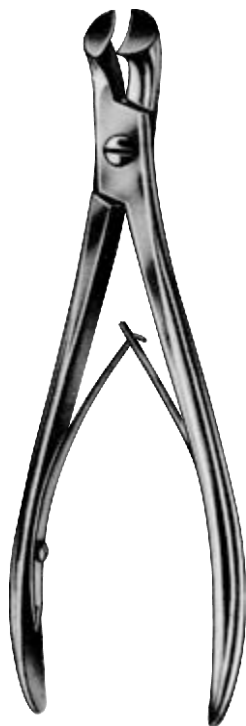

Markwalder
12-2043-20
20 cm/8"



12-2044-14 14
12-2044-17 17
12-2044-19 19
12-2044-22 22
Straight
gerade
droit
recto



Liston in
5 1/2 12-2045-14
6 3/4 12-2045-17
7 1/2 12-2045-19
8 3/4 12-2045-22
Curved
Gebogene
courbé
Curvo



Littauer-Liston
12-2046-15
15 cm/6"

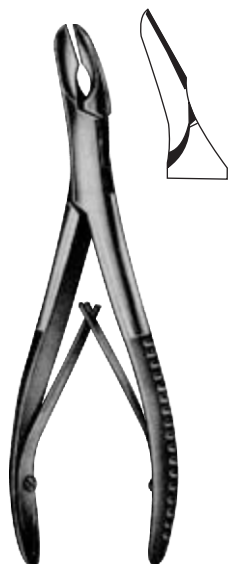

Cleveland
12-2047-15 15 cm/6"
12-2047-17 17 cm/6 3/4"



Bohler
15 cm/6"

12-2048-15
Straight
gerade
droit
recto

12-2049-15
Curved on flat
Gebogene auf flachen
Courbé sur le plat
Curva plana en

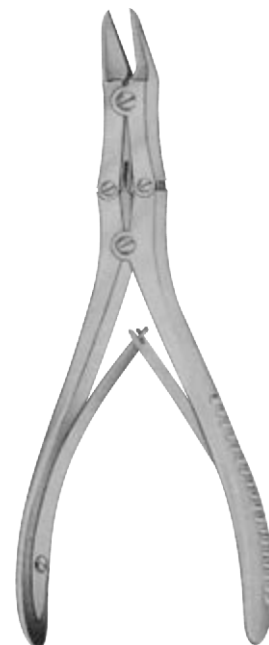

McIndoe
12-2050-17
17.5 cm/7"

Bone Instruments

Bone Cutting Forceps
Knochensplitterzangen

Pince de coupe d'os
Pince de coupe d'os...



Liston-Key(Horsley)
12-2051-27
27 cm/10½"

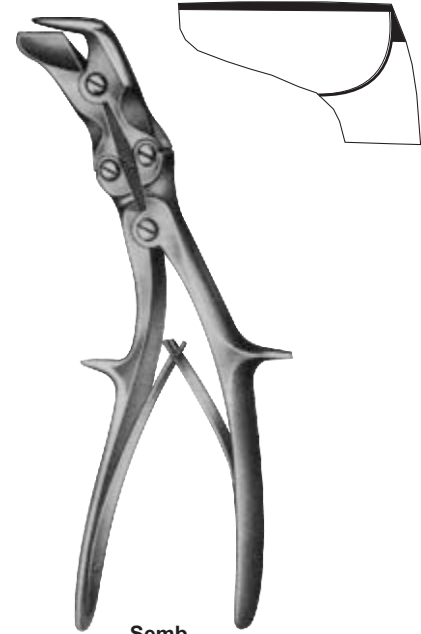

Semb
12-2052-27-24
24 cm/9½"



Kazanjian
12-2053-27-18
18 cm/7"



Ruskin-Liston
18.5 cm/7¼"

12-2054-18
Straight
gerade
droit
recto



12-2055-18
Curved on flat
Gebogene auf flachen
Courbé sur le plat
Curva plana en



Stille-Liston
23 cm/9"
27 cm/10½"

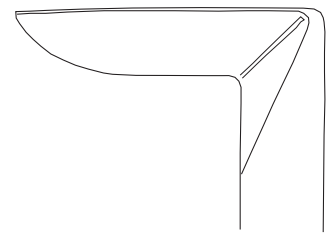

15-1061-27
27 cm/10½"

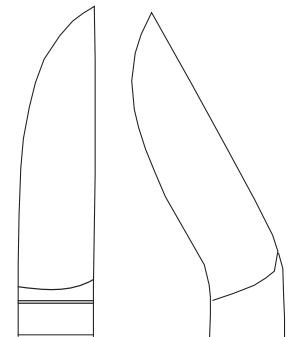

12-2056-23
12-2056-27

12-2057-23
12-2057-27

Bone Instruments

Nail Instruments and Finger Ring Cutters
 Nail Instruments und Fingerring Schneider

Nail Instruments et couteaux pour bagues
 Instrumentos y cortadores de uñas del dedo del anillo



12



12-2058-13
 13.5 cm/5"



18 cm/7"

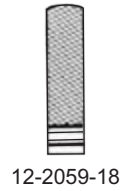

12-2059-18



12-2060-18

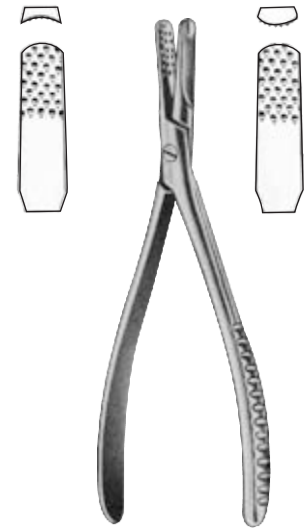

Radolf
 12-2061-13
 13.5 cm/5 1/4"



Saw blade
 Sägeblatt
 lame de scie
 hoja de sierra

12-2062-17
 17 cm/6 3/4"



Saw blade
 Sägeblatt
 lame de scie
 hoja de sierra

Walton
 12-2063-17
 17 cm/6 3/4"

Bone Instruments

Amputation and Resection Saws
Amputation und Resektion Sägen

Scies d'amputation et résection
Amputación y resección Sierras



Langenbeck
12-2064-23
23 cm/9"



Satterlee
12-2065-31
31 cm/12¼"



Charriere
12-2066-27 27 cm/10½"
12-2066-30 30 cm/12"
12-2066-34 34 cm/13½"

Spare saw blades
Spare Sägeblätter
Lames de scie de rechange
Cuchillas de recambio sierra

12-2067-43 3 mm
12-2067-45 5 mm
12-2067-47 7 mm

Complete with 3 blades
Komplett mit 3 Klingen
Livré avec 3 lames
Completo con 3 cuchillas
12-2067-39



Helferich-Bier

Spare saw blades
Spare Sägeblätter
Lames de scie de rechange
Cuchillas de recambio sierra

12-2068-12 12 mm
12-2068-15 15 mm

Complete with 2 blades
Komplett mit 2 Klingen
Livré avec 2 lames
Completo con 2 cuchillas
12-2068-35



Charriere

Bone Instruments

Bone Drills
Bone Drills

Perceuses os
Bone Drills



12



Adjustable handle
12-2069-28
28cm/11"



12-2070-11
Key only
Key nur
seule clé
clave única



Ralk
12-2071-00
accomodating up to 6.35mm Ø

Bone Instruments

Bone Drills
Bone Drills

Perceuses os
Bone Drills

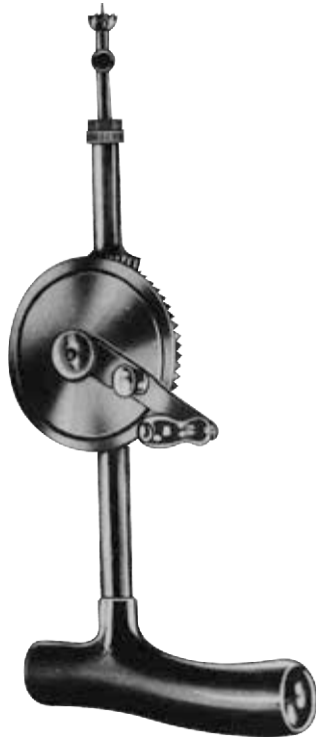

Stille
12-2072-00



Fig. 1
12-2072-01
Ø2,5mm



Fig. 2
12-2072-02
3,0mm



Fig. 3
12-2072-03
3,5mm



Fig. 4
12-2072-04
4,0mm



Fig. 5
12-2072-05
10,0mm



Fig. 6
12-2072-06
5,0mm



Fig. 7
12-2072-07
Ø8,0mm



Fig. 8
12-2072-08
12,0mm



Fig. 9
12-2072-09
16,0mm



Hudson
12-2073-00
27cm/10½"



Fig. 1
12-2073-01
Ø 9 mm



Fig. 2
12-2073-02
14mm



Fig. 3
12-2073-03
16mm



Fig. 4
12-2073-04
22mm



Cushing
12-2073-05
Ø14mm



Mckenzie
12-2073-09
Ø13mm



12-2073-00

Bone Instruments

Drill Guide and Dura Protecting Forceps
Bohrerführung und Dura Schutz Zange

Guide-mèche et Pince Dura Protection
Guía de broca y pinzas Dura Protección



12



Adson
12-2074-15
15 cm/6"

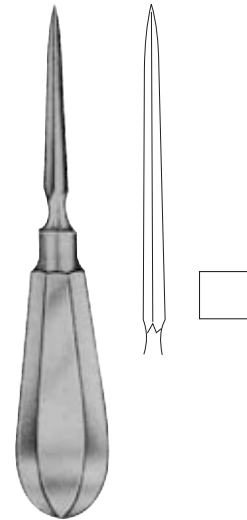

12-2075-14
14 cm/5½"



12-2076-14
14 cm/5½"

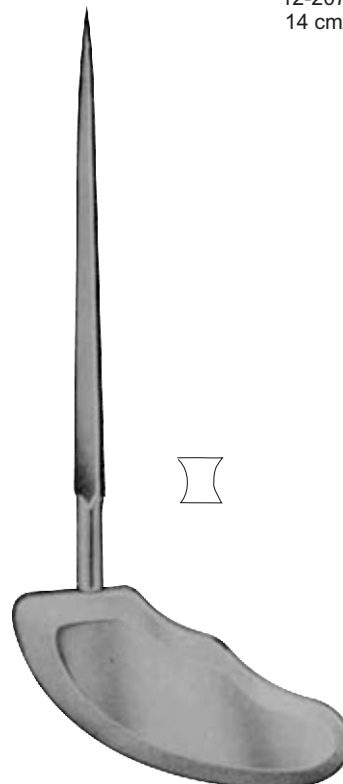

Perthes
12-2077-21
21 cm/8¼"

Bone Instruments

Wire Seizing Forceps
Draht Zange ergreifen

Pince fil Saisir
Pinzas de alambre Aprovechar

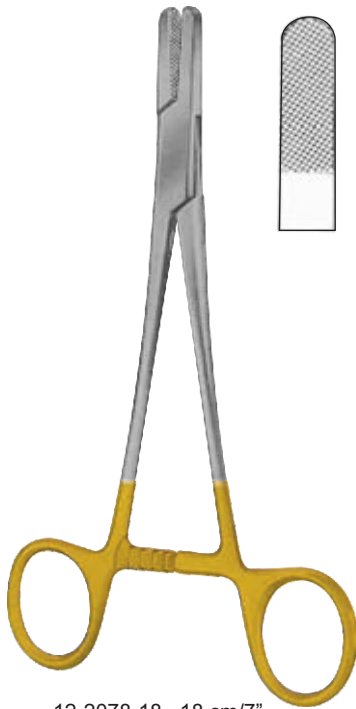

12-2078-18 18 cm/7"
12-2078-20 20 cm/8"

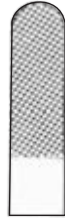

12-2079-16
15 cm/6"

12-2079-20
20 cm/8"

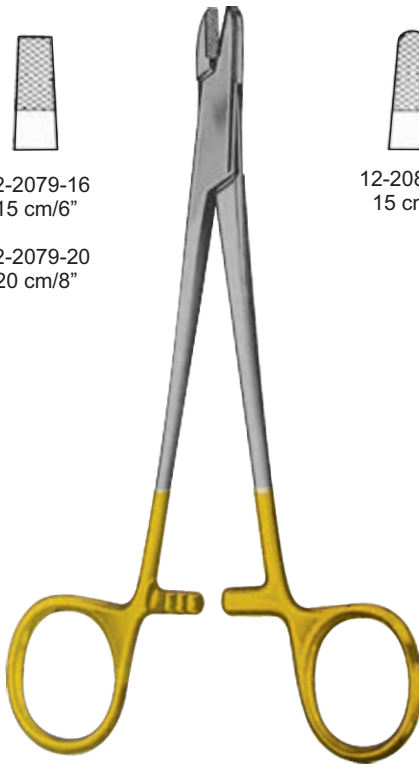

12-2080-16
15 cm/6"



12-2081-14
14 cm/5½"



12-2082-16
16 cm/6¼"

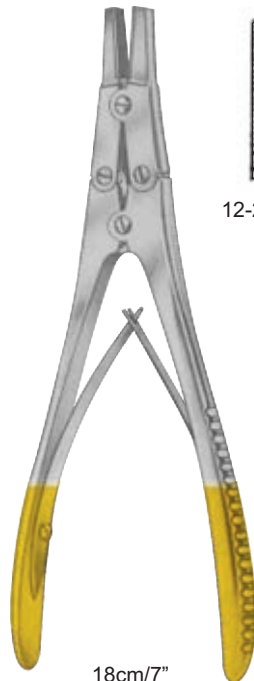

12-2083-01

12-2083-02

12-2083-03

12-2083-04

12-2083-05

Bone Instruments

Wire Seizing Forceps
Draht Zange ergreifen

Pince fil Saisir
Pinzas de alambre Aprovechar



12

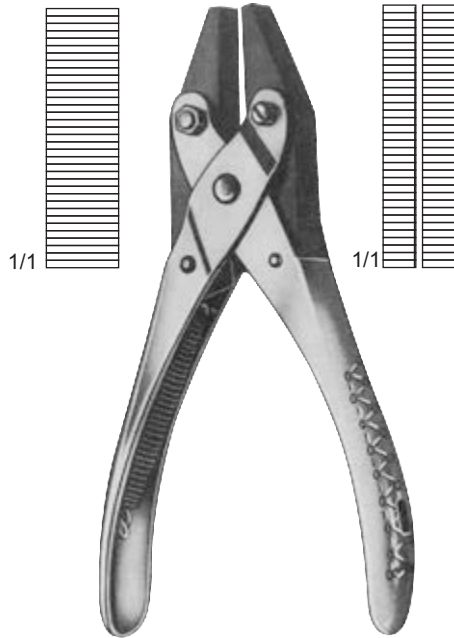

12-2084-15
15.5 cm/6"

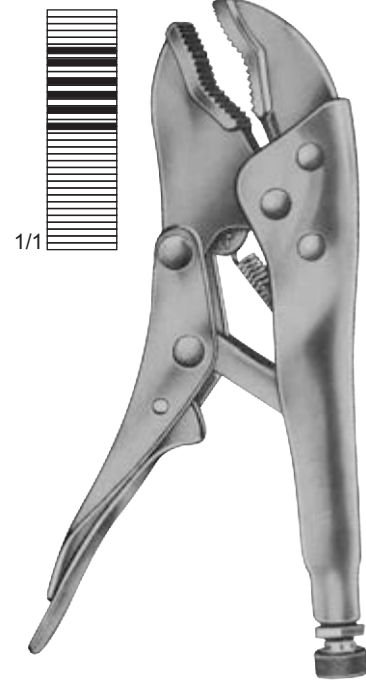

12-2085-18
18 cm/7"



12-2086-13 13 cm/5"
12-2086-18 18 cm/7"

Bone Instruments

Wire Cutting Pliers
Drahtschneidezangen

Pince coupante fil
Alicates de corte de alambre

For soft wire
with a diam. of max.

For hard wire
with a diam. of max.

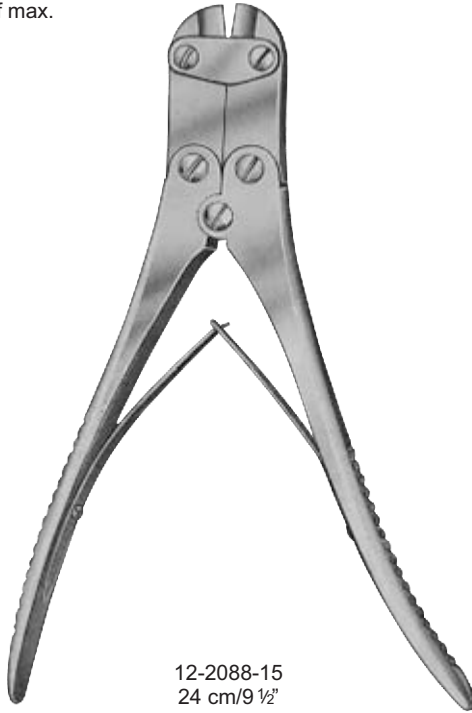

12-2088-15
24 cm/9 1/2"
4.0 mm
3.5 mm



12-2089-18
18.5 cm/7 1/4"
1.7 mm
1.7 mm

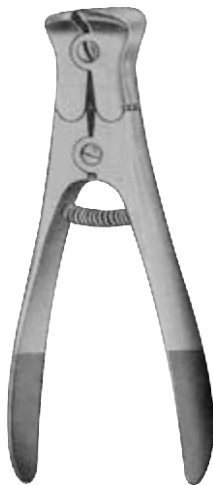

2.0 mm
1.5 mm
12-2090-15
15 cm/6"



2.0 mm
2.0 mm
12-2091-16
16 cm/6 1/4"

Bone Instruments

Wire Cutting Pliers
Drahtschneidezangen

Pince coupante fil
Alicates de corte de alambre



12



12-2092-12
12 cm/4 3/4"

0.7 mm
0.5 mm



12-2093-15
15 cm/6"

2.0 mm
1.0 mm



12-2094-18
18 cm/7"

2.0 mm
1.7 mm

Bone Instruments

Wire Cutting Pliers
Drahtschneidezangen

Pince coupante fil
Alicates de corte de alambre



2.5 mm
1.5 mm

12-2095-18
18.5 cm/7 1/4"



2.0 mm 3.0 mm
1.7 mm 2.5 mm

12-2096-18
18 cm/7"

12-2097-22
22 cm/8 3/4"



3.0 mm

12-2098-22
22 cm/8 3/4"



7.5 mm

12-2099-47 47 cm/18 1/2"
12-2099-57 57 cm/22 1/2"

Bone Instruments

Extension Bows
Erweiterung Bögen

Arcs d'extension
Arcos de extensión



12

with 3 traction hooks
mit 3 Traktion Haken
avec 3 crochets de traction
con 3 ganchos de tracción

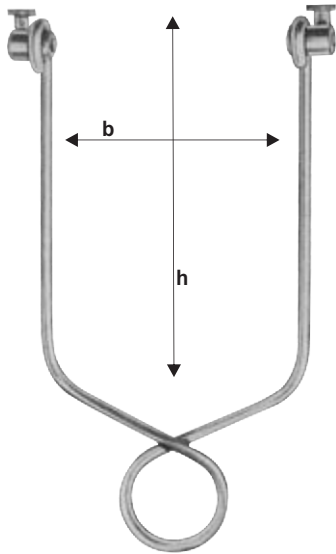

cm h x b	in h x b	
16 x 9	6 1/4 x 3 1/2	12-2100-16
21 X 11	8 1/4 X 4 1/2	12-2100-21
21 X 15	8" X 6"	12-2100-15



Kirschner

Clear width
lichte Breite
largeur libre
anchura libre

	cm	In
12-2101-01	9,5x7	3 3/4 x 2 3/4
12-2101-02	10,5x10,5	4 1/4 x 4 1/4
12-2101-03	12x12	4 3/4 x 4 3/4
12-2101-04	15,5x15,5	6x6
12-2101-05	20x15,5	8x6

with 3 traction hooks
mit 3 Traktion Haken
avec 3 crochets de traction
con 3 ganchos de tracción

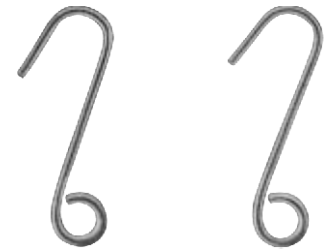

12-2104-40

12-2104-42



Kirschner

Clear width
lichte Breite
largeur libre
anchura libre

12-2102-18	18x10	07x04
12-2102-27	27x16	10 1/2 x 6 1/4

cm	in
18x10	07x04
27x16	10 1/2 x 6 1/4



Kirschner

12-2103-01	Small Pattern
12-2103-02	Medium Pattern
12-2103-03	Large Pattern

Wire Strainer
Draht Strainer
Passoire fil
Colador de alambre

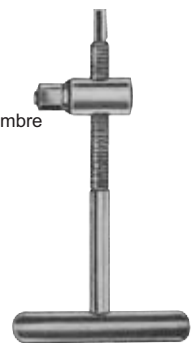

12-2104-20

Bone Instruments

Bone Wire, Twisting Instruments and Guides
Knochen-Wire, Zwirn-Instrumente und Guides

Fil d'os, instruments de torsion et Guides
Alambre de hueso, instrumentos giratorios y guías



Loute
12-2105-21
21 cm/8¼"

Bone Wire Tighteners
Knochen Draht Spanner
Tendeurs Fils os
Tensores de cables y Bone



Demel
12-2106-28
28 cm/11"



Demel

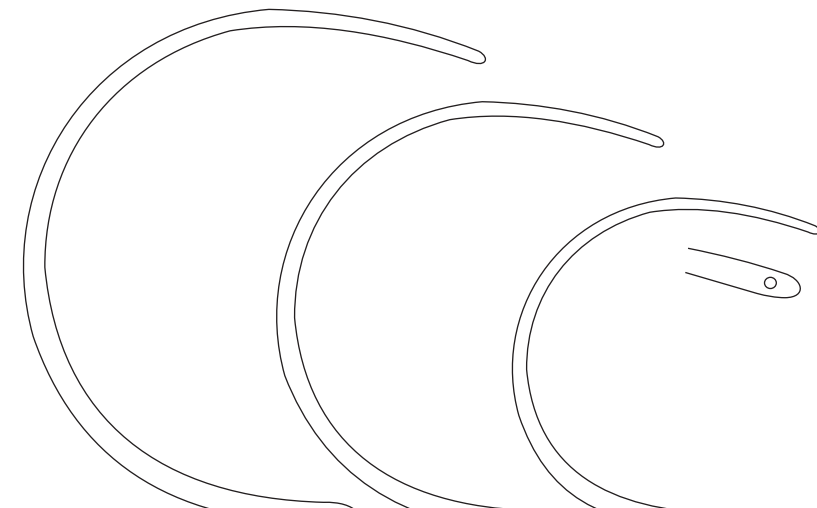

Bone Wire Guides
Knochen Draht Guides
Guides-câbles os
Guías Bone Wire

Fig. 1 12-2107-01
Fig. 2 12-2107-02
Fig. 3 12-2107-03

Fig. 1

Fig. 2

Fig. 3

Bone Instruments

Bone Nail
Knochen Nagel

Des clous à os
Bone uñas

12



length **Schanz**

length	Ø 5 mm
8 cm	12-2108-08
10 cm	
12 cm	12-2108-12
14 cm	
15 cm	12-2108-15
16 cm	
17 cm	12-2108-17
18 cm	
20 cm	12-2108-20
22 cm	
25 cm	12-2108-25
30 cm	

with triangular end
mit dreieckigem Ende
avec extrémité triangulaire
con extremo triangular



with trocar point
mit Trokarspitze
avec pointe trocart
con punto de trocart

Length
Länge
longueur
longitud

Steinmann

Length	Ø 4 mm	Ø 4,5 mm	Ø 5 mm
8 cm	12-2109-08	12-2110-08	12-2111-08
10 cm	12-2109-10	12-2110-10	12-2111-10
12 cm	12-2109-12	12-2110-12	12-2111-12
14 cm	12-2109-14	12-2110-14	12-2111-14
15 cm			
16 cm	12-2109-16	12-2110-16	12-2111-16
17 cm			
18 cm	12-2109-18	12-2110-18	12-2111-18
20 cm	12-2109-20	12-2110-20	12-2111-20
22 cm	12-2109-22	12-2110-22	12-2111-22
25 cm	12-2109-25	12-2110-25	12-2111-25
30 cm	12-2109-30	12-2110-30	12-2111-30

Bone Instruments

Mallets
Mallets

Maillets
mazos



22 cm/8 1/2"

300 g 12-2112-10
500 g 12-2112-35
600 g 12-2112-50
940 g 12-2112-70



with interchangeable
mit austauschbaren
avec interchangeables
intercambiable con

Ø 30 mm
215 g

12-2113 -24
24.5 cm/8 3/4"



Ø 30 mm
400 g

Ø 42 mm

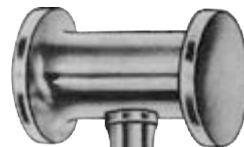

Ø 45 mm
300 g



12-2114 -24
24 cm/9 1/2"



Bergmann
12-2115-24
24 cm/9 1/2"

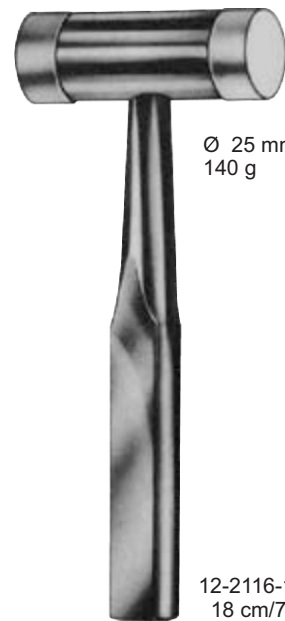

Ø 25 mm
140 g

12-2116-18
18 cm/7"

Bone Instruments

Mallets
Mallets

Maillets
mazos

12



150 g

Williger
12-2117-23
23 cm/9"



∅ 30 mm
460 g

Bergmann
12-2118-23
23 cm/9"



1 Side Flat
1 Side Convex

Cottle
12-2119-19
∅ 30 mm
19 cm/7 1/2"
350 g

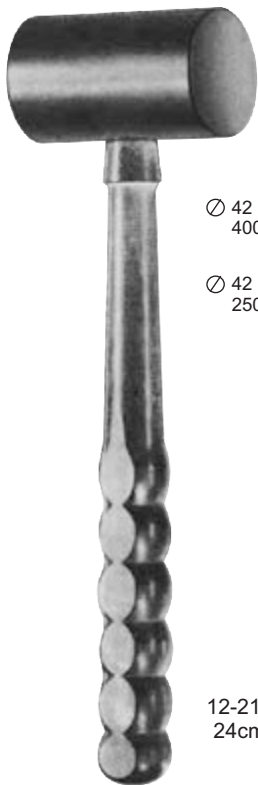

∅ 42 mm
400 g

∅ 42 mm
250 g

12-2120-24
24cm/9 1/2"



∅ 30 mm

Ombredanne
12-2121-24
23.5cm/9 1/4"

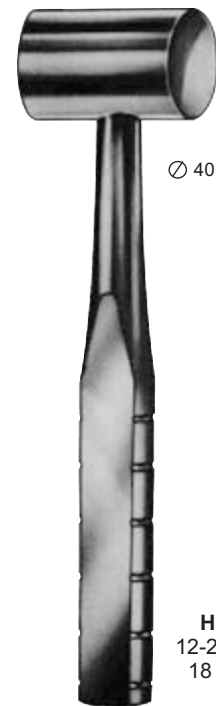

∅ 40 mm

Heath
12-2122-18
18 cm/7"

Bone Instruments

Mallets
Mallets

Maillets
mazos

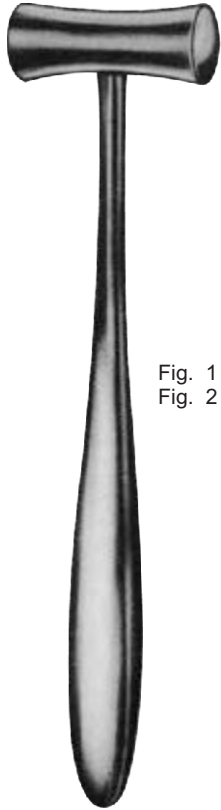

Lucae
19 cm/7½"

Fig. 1 12-2123-19 19mm Ø 230 g
Fig. 2 12-2123-25 25mm Ø 260 g

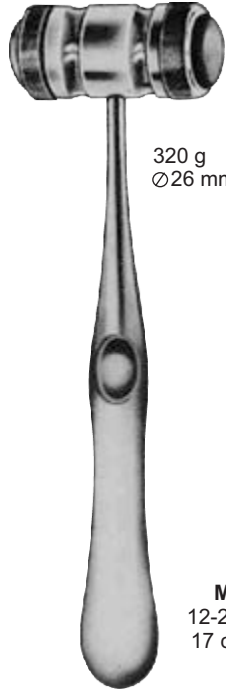

320 g
Ø26 mm

Mead
12-2124-17
17 cm/6¾"



Williger
12-2125-16
16.5 cm/6½"



165 g
Ø 22 mm

12-2126-19
19 cm/7½"



Gerzog
12-2127-19
19 cm/7½"



200 g
22 mm Ø
(7 oz.)

Partsch
12-2128-18
18 cm/7"

Bone Instruments

Tendon Seizing Instruments
Tendon ergriff Instruments

Tendon Instruments Saisir
Aprovechar los instrumentos del tendón



12



Fischer
12-2129-31
31 cm/12¼"



Brand

12-2130-50
50 cm/19½"
6 mm Ø



12-2131-30
30 cm/12"
3 mm Ø



Brand
12-2132-50
50 cm/19½"

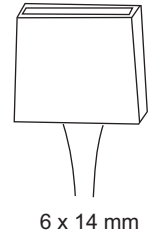

6 x 14 mm

Tendon Strippers
Sehnen Strippers
Décapants tendon
Strippers tendón



mm Ø
4.0 12-2133-40
4.5 12-2133-45
5.5 12-2133-55

Flexible Shaft
flexible Welle
arbre flexible
eje flexible



Steinmann
12-2134-50
16 cm/6⅓"

Bone Instruments

Tendon Seizing Instruments
Tendon ergriff Instruments

Tendon Instruments Saisir
Aprovechar los instrumentos del tendón

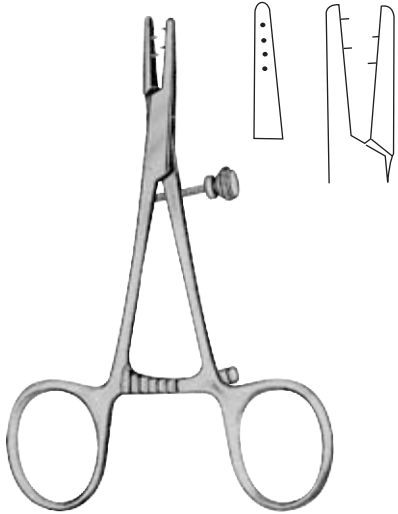

Steinmann
12-2135-13
13 cm/5"



12-2136-20

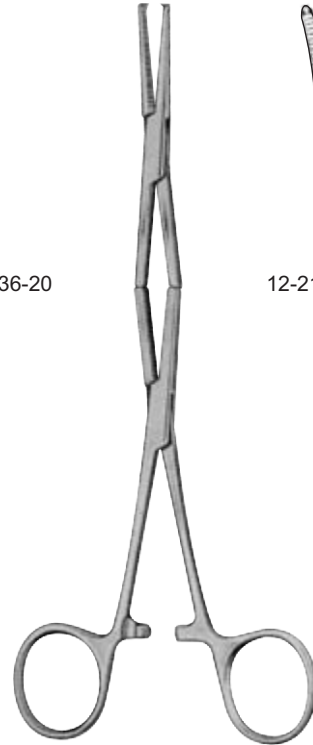

12-2137-20

20 cm/8"



Carroll
12-2138-11
11 cm/4½"

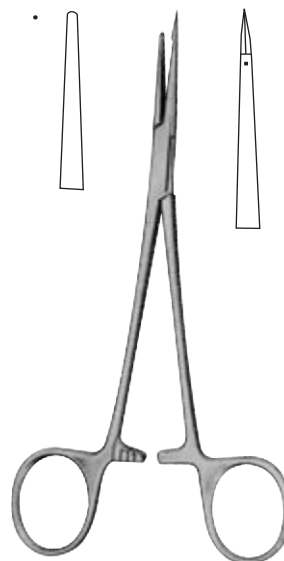

12-2139-15
15 cm/6"

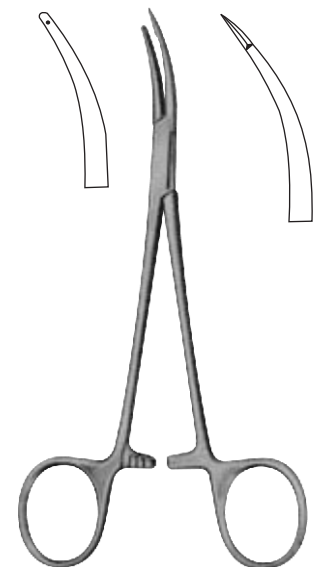

12-2140-15
15 cm/6"

Bone Instruments

Tendon Seizing Instruments
Tendon ergriff Instruments

Tendon Instruments Saisir
Aprovechar los instrumentos del tendón

12

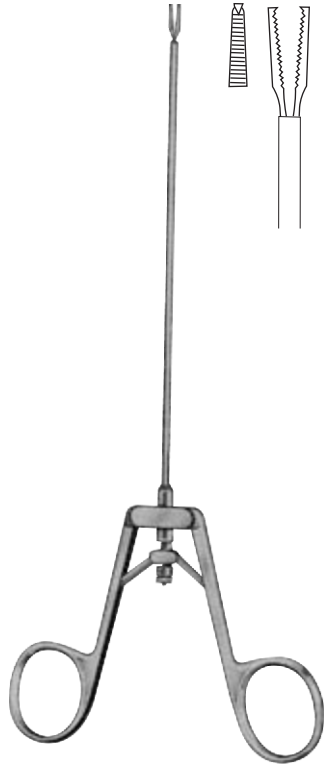

Kleinert-Kutz
12-2141-20
16 cm/8"



Brand
12-2142-15 16 cm/6"
12-2142-19 19 cm/7½"
12-2142-24 24 cm/9½"

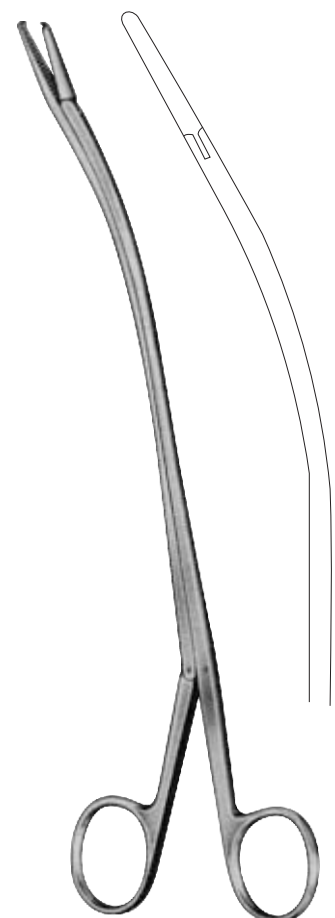

Brand
12-2143-15 16 cm/6"
12-2143-19 19 cm/7½"
12-2143-24 24 cm/9½"

Cardiovascular Instruments

Rib Shears
Rib Shears

Costotome
Tijeras de costilla



13-2144-23
23 cm/9"
Bone Shears



13-2145-23
23 cm/9"
Bone Shears



Glick
13-2146-23
23 cm/9"
Drawing Cut

Cardiovascular Instruments

Rib Shears, Sternum Chisels
Rib, Sternumscheren Meißel

Costotome, ciseaux Sternum
Tijeras de costillas, esternón cinceles



13



Sauerbruch
13-2147-24 24 cm/9½"
13-2147-26 26 cm/10¼"



Giertz-Stillle
13-2148-27
27 cm/10½"

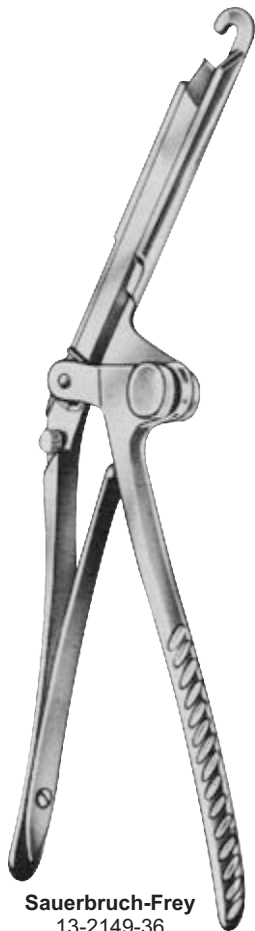

Sauerbruch-Frey
13-2149-36
36 cm/14"

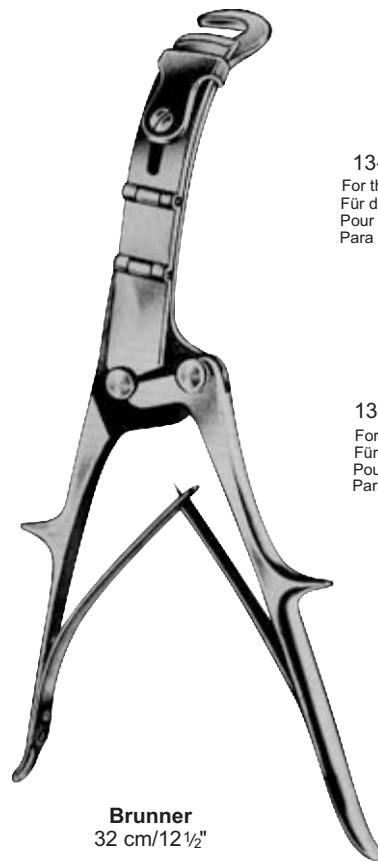

Brunner
32 cm/12½"

13-2150-32
For the Right Hand
Für die rechte Hand
Pour la main droite
Para la mano derecha

13-2151-32
For the left Hand
Für die linke Hand
Pour la main gauche
Para la mano izquierda



Lebsche
13-2152-24
24.5 cm/9¾"

Cardiovascular Instruments

Rib Spreaders
Wundsperrer

Épandeurs Rib
Separadores de costilla

Schema of Dimensions
Schema der Dimensionen
Schéma des dimensions
Esquema de Medidas

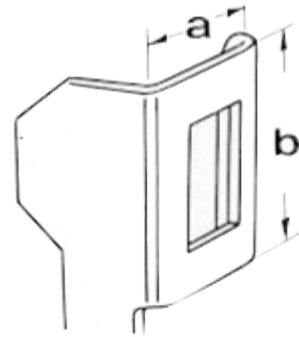

Size of Blades
Größe der Blätter
Taille des lames
Tamaño de Espadas

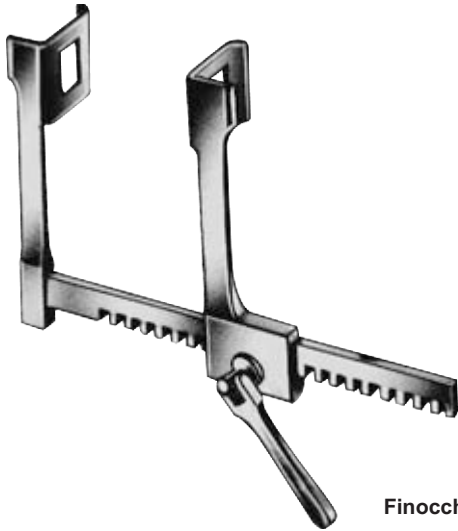

Finocchietto-Baby

	a	b	c
13-2153-00	18 mm	20 mm	75 mm

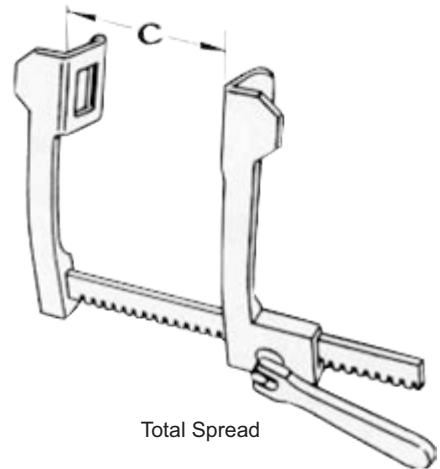

Total Spread

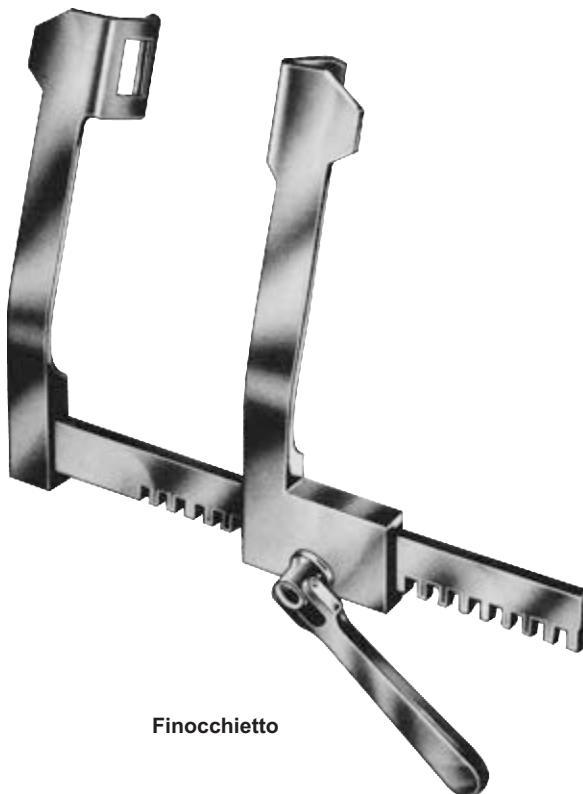

Finocchietto

	a	b	c
13-2154-01	38 mm	45 mm	165 mm
13-2154-02	44 mm	65 mm	200 mm
13-2154-03	44 mm	65 mm	250 mm
13-2154-04	44 mm	65 mm	300 mm
13-2154-05	65 mm	65 mm	200 mm
13-2154-06	65 mm	65 mm	250 mm
13-2154-07	65 mm	65 mm	300 mm

Cardiovascular Instruments

Rib Spreaders
Wundsperrer

Épandeurs Rib
Separadores de costilla



13

With 2 Pairs of Interchangeable Blades
Mit 2 Paar Wechselklingen
Avec 2 paires de lames interchangeables
Con 2 pares de cuchillas intercambiables

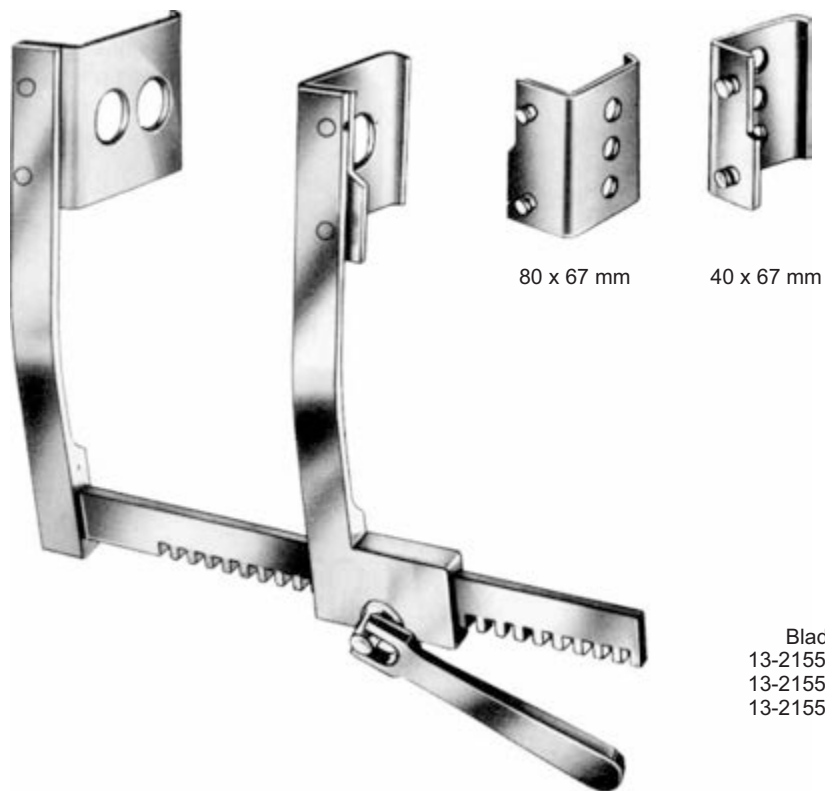

Blade Opening
13-2155-01 200 mm/8"
13-2155-02 250 mm/10"
13-2155-03 305 mm/12"

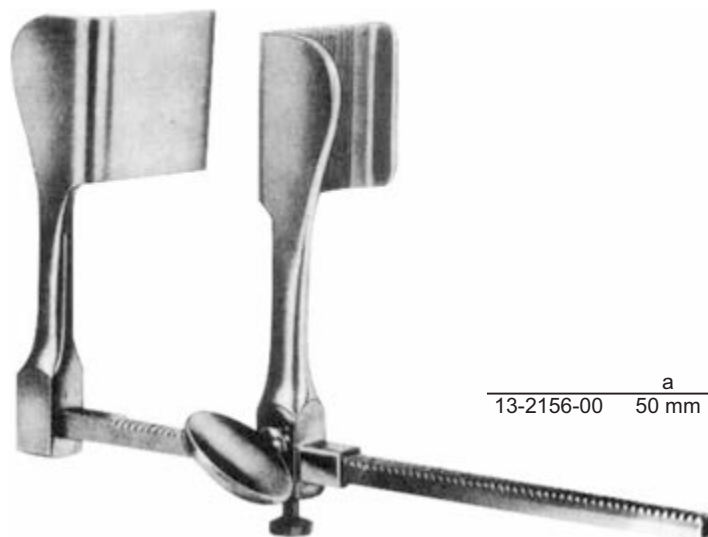

13-2156-00 a b c
50 mm 45 mm 165 mm

Tuffier

Cardiovascular Instruments

Rib Spreaders
Wundsperrer

Épandeurs Rib
Separadores de costilla

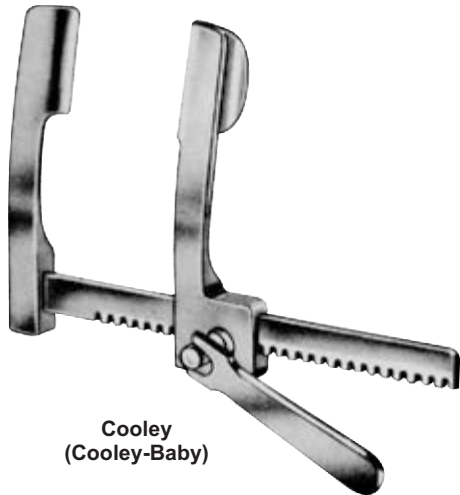

**Cooley
(Cooley-Baby)**

	a	b	c
13-2157-01	12 mm	17 mm	75 mm
13-2157-02	16 mm	30 mm	105 mm
13-2157-03	37 mm	49 mm	200 mm

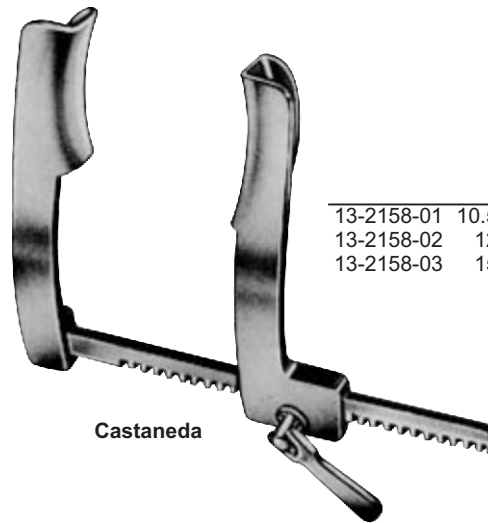

Castaneda

	a	b	c
13-2158-01	10.5 mm	32 mm	65 mm
13-2158-02	12 mm	45 mm	70 mm
13-2158-03	15 mm	60 mm	120 mm

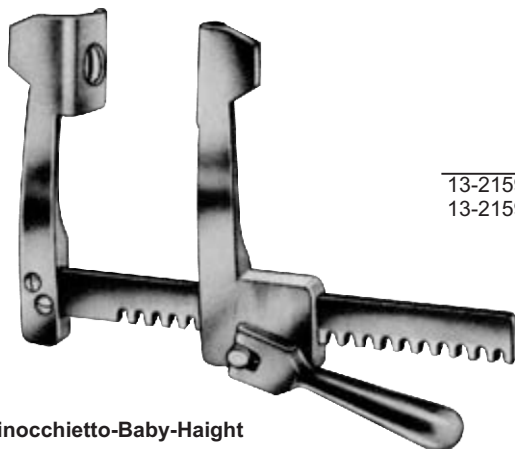

Finocchietto-Baby-Haight

	a	b	c
13-2159-01	15 mm	15 mm	75 mm
13-2159-02	31 mm	31 mm	100 mm

Cardiovascular Instruments

Rib Spreaders
Wundsperrer

Épandeurs Rib
Separadores de costilla



13



Haight

	a	b	c
13-2160-01	30 mm	30 mm	65 mm
13-2160-02	30 mm	30 mm	90 mm

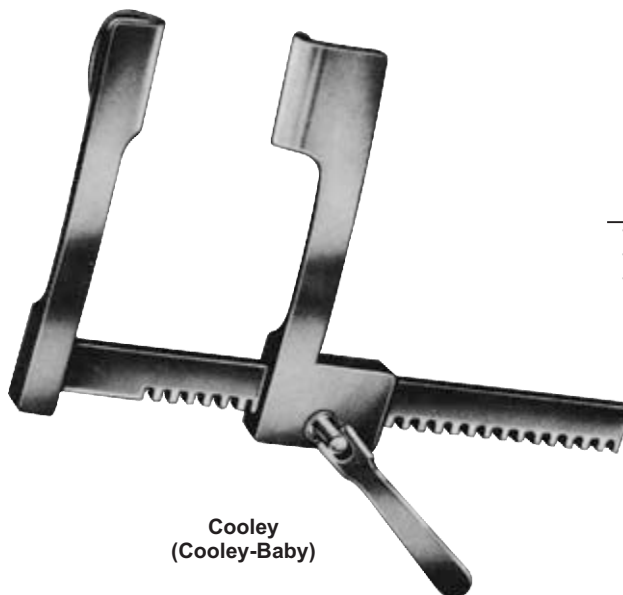

Cooley
(Cooley-Baby)

	a	b	c
13-2161-01	15 mm	30 mm	75 mm
13-2161-02	21 mm	45 mm	145 mm
13-2161-03	32 mm	50 mm	190 mm

Cardiovascular Instruments

Rib Spreaders
Wundsperrer

Épandeurs Rib
Separadores de costilla

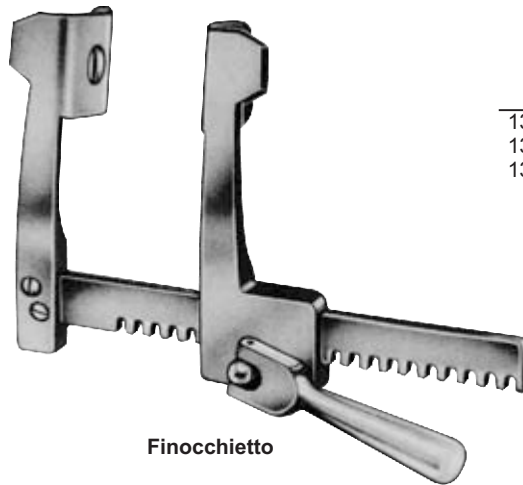

Finocchetto

	a	b	c
13-2162-01	38 mm	44 mm	135 mm
13-2162-02	52 mm	62 mm	175 mm
13-2162-03	85 mm	65 mm	175 mm

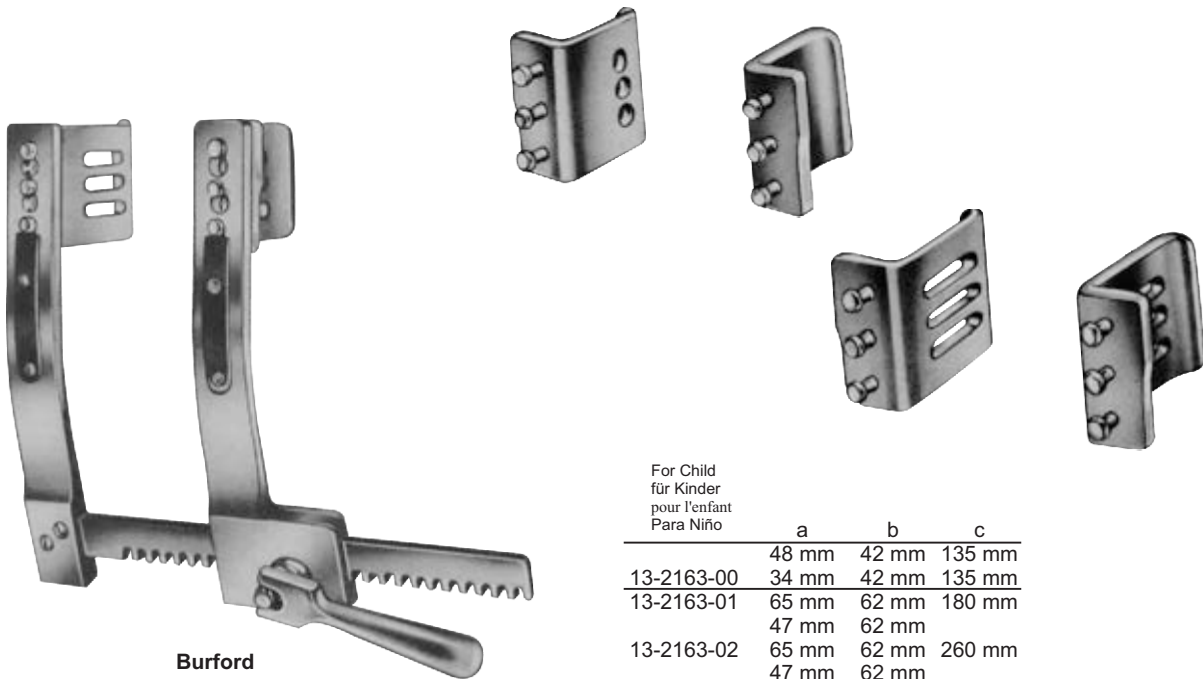

Burford

With 2 Pairs of Blades
Mit 2 Paar Blades
Avec 2 paires de lames
Con 2 pares de hojas

For Child
für Kinder
pour l'enfant
Para Niño

	a	b	c
	48 mm	42 mm	135 mm
13-2163-00	34 mm	42 mm	135 mm
13-2163-01	65 mm	62 mm	180 mm
	47 mm	62 mm	
13-2163-02	65 mm	62 mm	260 mm
	47 mm	62 mm	
13-2163-03	65 mm	62 mm	300 mm
	47 mm	62 mm	

Cardiovascular Instruments

Rib Spreaders
Wundsperrer

Épandeurs Rib
Separadores de costilla



13

With 2 pairs of interchangeable blades
Mit 2 Paar auswechselbaren Klingen
Avec 2 paires de lames interchangeables
Con 2 pares de hojas intercambiables

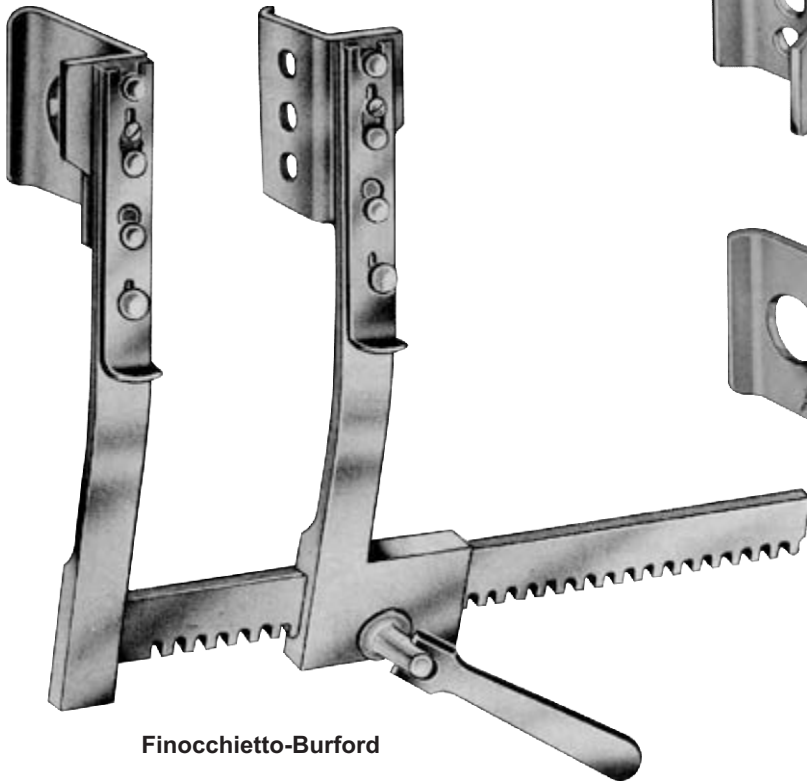

Finocchietto-Burford



Blades
13-2164-31
80x67 mm



Blades
13-2163-30
40x67 mm

Total Spread

13-2165-01	200mm/8"
13-2165-02	250mm/10"
13-2165-03	305mm/12"



Tuffier

	a	b	c
13-2166-00	50 mm	45mm	165mm

Cardiovascular Instruments

Rib Spreaders
Wundsperrer

Épandeurs Rib
Separadores de costilla

◀ 200 mm ▶

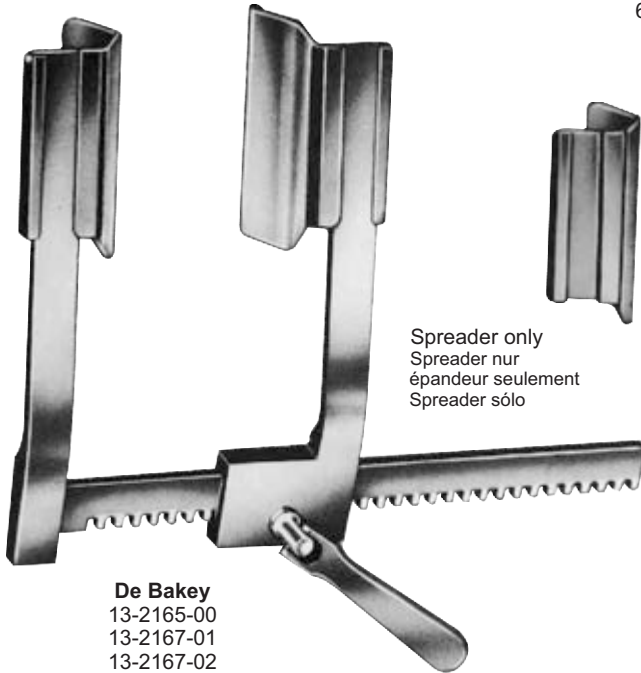

De Bakey
13-2165-00
13-2167-01
13-2167-02
13-2167-03

With 5 Pairs of Blades
Mit 5 Paar Blades
Avec 5 paires de lames
Con 5 pares de cuchillas



13-2167-01
60 x 60 mm



13-2167-02
50 x 80 mm



Spreader only
Spreader nur
épandeur seulement
Spreader sólo

13-2167-03
40 x 100 mm



13-2167-04
80 x 60 mm



13-2167-05
50 x 66 mm



◀ 150 mm ▶

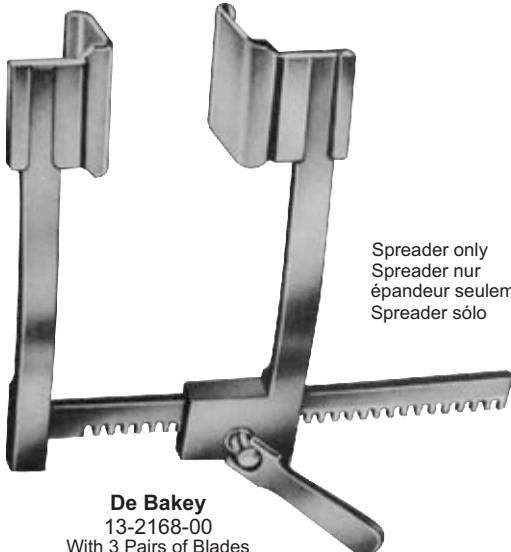

De Bakey
13-2168-00
With 3 Pairs of Blades
Mit 3 Paar Blades
Avec 3 paires de lames
Con 3 pares de cuchillas



13-2168-01
30 x 30 mm



13-2168-02
40 x 40 mm



13-2168-03
50 x 50 mm



Cardiovascular Instruments

Rib Spreaders
Wundsperrer

Épandeurs Rib
Separadores de costilla



13

◀ Fig. 1 15 cm/6" ▶
◀ Fig. 2 20 cm/8" ▶

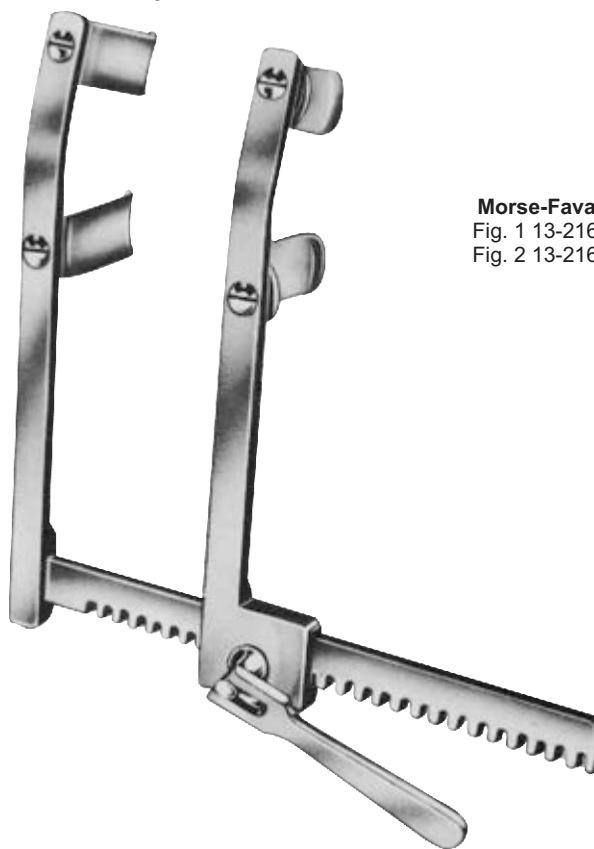

Morse-Favaloro
Fig. 1 13-2169-01
Fig. 2 13-2169-02

75 x 75 mm

Thoracic Retractor

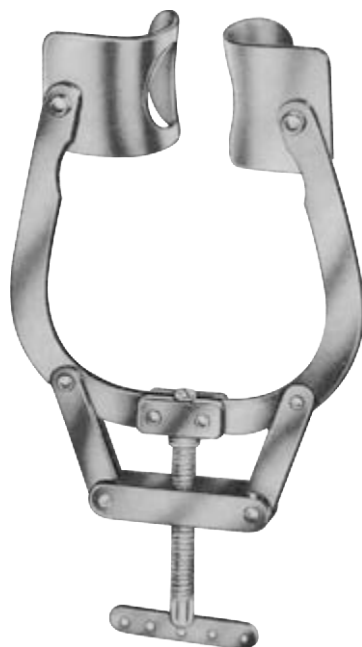

42 x 65 mm

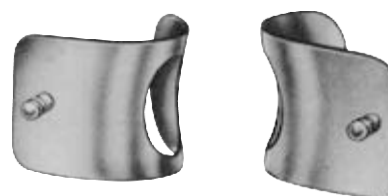

(Mercedes-Retractor)

13-2170-00

Complete
vervollständigen
completar
completar

Cardiovascular Instruments

Rib Contractors and Lung Spatulas

Rib Contractors und Lungenforschung Spatel

Entrepreneurs des côtes et du poumon Spatules

Contratistas de costilla y espátulas de pulmón



Sellors
13-2171-19
19 cm/7½"



Bailey-Baby
13-2172-14
14 cm/5½"



Bailey
13-2173-16
16 cm/6¼"



Bailey-Gibbon
13-2174-16
16 cm/6¼"

Cardiovascular Instruments

Lung Spatulas
Lung Spatel

Spatules du poumon
Espátulas de pulmón

13



Allison

13-2175-25 25.5 cm/10"
13-2175-30 30.0 cm/12"

Lung Spatulas
Lung Spatel
Spatules pulmonaires
Espátulas de pulmón

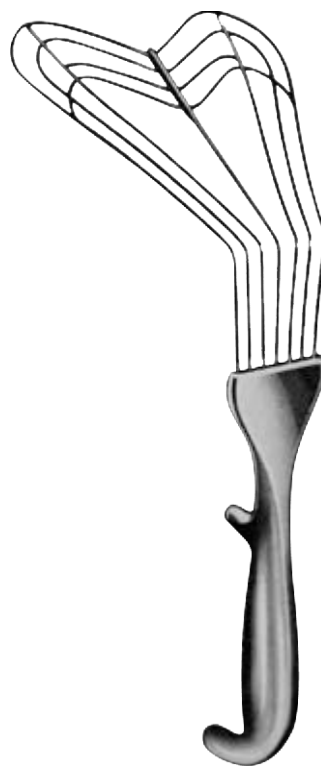

13-2176-30
30 cm/12"

Cardiovascular Instruments

Bronchus Clamps and Blood Vessel Clamps
Bronchus Schellen und Blutgefäßen Schellen

Pinces des bronches et des colliers Vasculopathies
Abrazaderas Abrazaderas de los bronquios y los vasos sanguíneos



Price-Thomas
13-2177-22
22 cm/8¾"

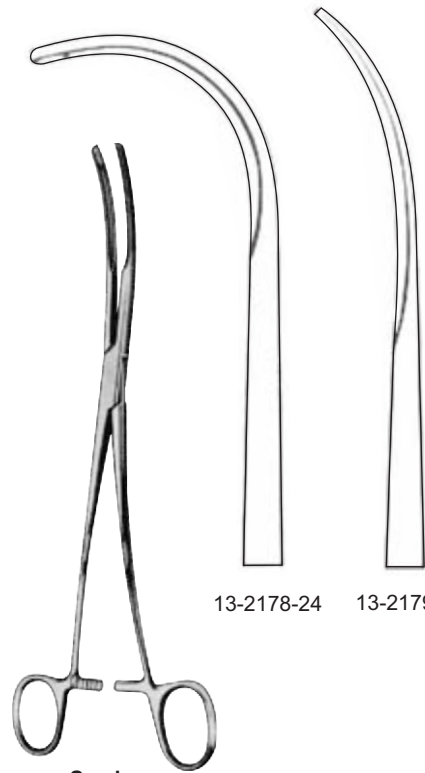

Semb
24 cm/9½"

13-2178-24 13-2179-24

Lung grasping forceps



Lovlace
13-2180-20
20 cm/8"



Lovlace
13-2181-20
20 cm/8"

Cardiovascular Instruments

Blood Vessel Clamps
Blutgefäß Schellen

Pinces Vasculopathies
Las abrazaderas de los vasos sanguíneos



13



13-2182-01
13-2182-02

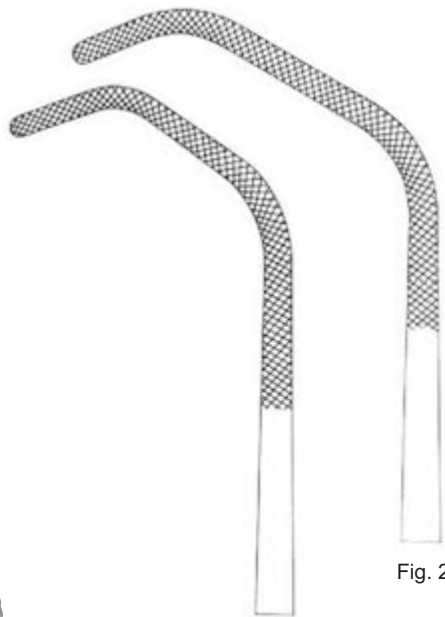

Fig. 1

Fig. 2

Satinsky
26.5 cm/10½"
Fig. 1
Fig. 2



13-2183-01
13-2183-02



Baby-Satinsky
13-2184-15
15 cm/6"



Harken
24 cm/9½"



13-2185-01



13-2185-02



13-2185-03



13-2185-04

Cardiovascular Instruments

Atrauma Bulldog Clamps
Atrauma Bulldogklemmen

Atraumatique Pinces Bulldog
Atrauma Bulldog Clamps



De Bakey-Satinsky
13-2186-07
7 cm/2³/₄"



De Bakey-Satinsky
13-2187-09
9 cm/3¹/₂"

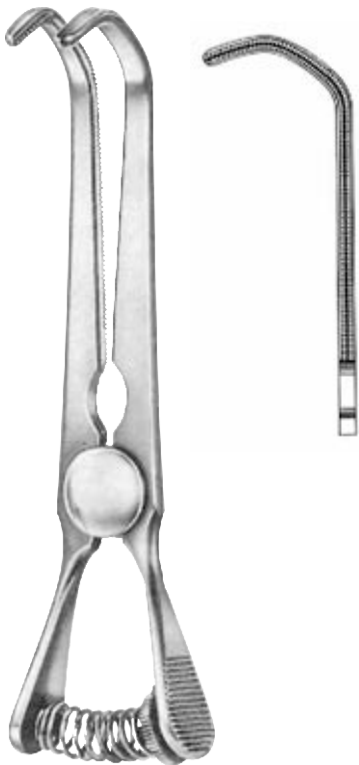

De Bakey-Satinsky
13-2188-10
10 cm/4"



Glover
13-2189-06
6 cm/2¹/₄"

Cardiovascular Instruments

Atrauma Bulldog Clamps
Atrauma Bulldogklemmen

Atraumatique Pincés Bulldog
Atrauma Bulldog Clamps



13



Santulli
13-2190-07
7 cm/2¾"

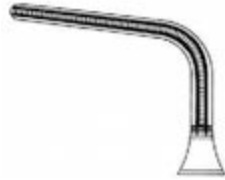

Gregory-Soft



13-2191-09
9 cm/3½"



13-2191-11
11 cm/4½"



Gregory



13-2192-09
10.5 cm/4"



13-2192-10
10.5 cm/4"

Cardiovascular Instruments

Bulldog Clamps
Bulldogklemmen

Pinces Bulldog
Bulldog Clamps



Glover



13-2193-09
7cm/2¾"

13-2194-11
7.5 cm/3"

13-2195-09
9 cm/3½"

13-2196-11
11 cm/4¼"



Glover

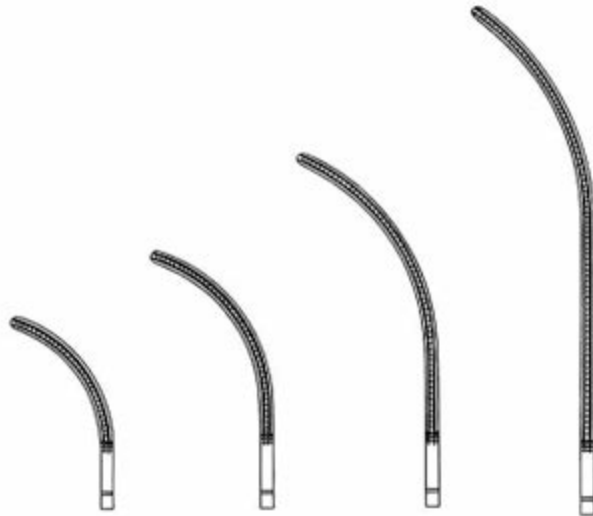

13-2197-09
6.5cm/2½"

13-2198-11
7 cm/2¾"

13-2199-09
8.5 cm/3¼"

13-2200-11
10.5 cm/4"

Cardiovascular Instruments

Bulldog Clamps
Bulldogklemmen

Pincas Bulldog
Bulldog Clamps



13



DeBakey

13-2201-07
7.5 cm/3"

13-2201-08
8.5 cm/3 1/4"

13-2201-10
10 cm/4"

13-2201-12
12 cm/4 3/4"

Applying Forceps
for Bulldog clamps

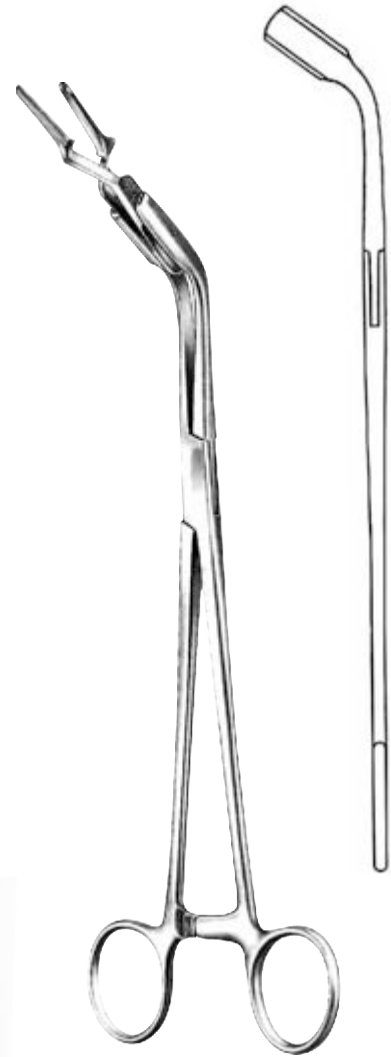

13-2203-23
23.5 cm/9 1/4"



DeBakey

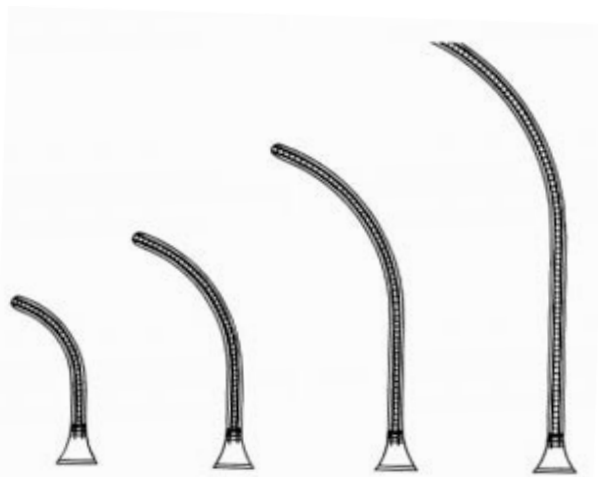

13-2202-07
7.5 cm/3"

13-2202-08
8.5 cm/3 1/4"

13-2202-09
9.5 cm/4 3/4"

13-2202-12
11 cm/4 1/4"

Cardiovascular Instruments

Haemostatic Forceps and Aortic Clamps
Arterienklemme und Aorten-Schellen

Forceps Hémostatique et clamps aortiques
Pinzas hemostáticas y Abrazaderas aórticas



DeBakey-Rankin

13-2204-01
16 cm/6¼"

13-2204-02
16 cm/6¼"

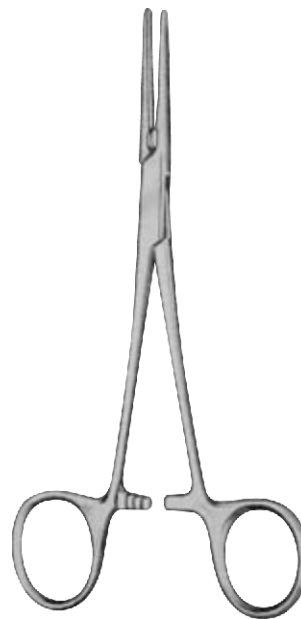

DeBakey-Mosquito

13-2205-01
15 cm/6"

13-2205-02
16 cm/6"



Ochsner

13-2206-23
23.5 cm/9¼"



Diethrich

13-2207-22
22cm/6¾"

Cardiovascular Instruments

Multi Purpose vascular Clamps
Multi Purpose Gefäßklemmen

Pinces Multi Purpose vasculaires
Pinzas Multiuso vasculares

13



13-2208-00



15°
13-2208-15



30°
13-2208-30

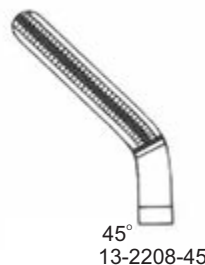

45°
13-2208-45

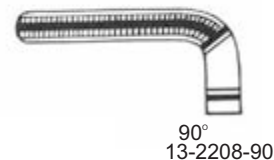

90°
13-2208-90

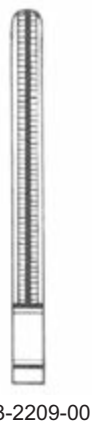

13-2209-00



15°
13-2209-15



30°
13-2209-30

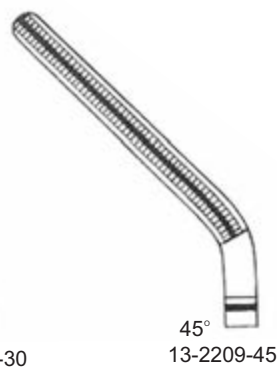

45°
13-2209-45



90°
13-2209-90



Dardik
17 cm/6³/₄"

Cardiovascular Instruments

Peripheral Vascular Clamps
Peripheral Vascular Clamps

Clamps vasculaires périphériques
Pinzas vasculares periféricas



13-2210-17
17.5 cm/6¾"



13-2210-18
18 cm/7"



13-2210-19
18.5 cm/7¼"



13-2211-18
18 cm/7"



Cardiovascular Instruments

Profunda and Carotid shunt Clamps
Profunda und Karotis-Shunt-Schellen

Pinces shunt profunda et carotidienne
Profunda y abrazaderas de derivación carotídea



13



Gregory



13-2212-14
13 cm/5"

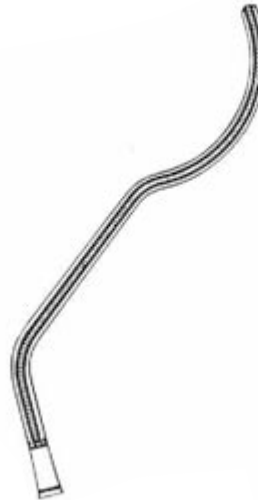

13-2212-16
16 cm/6 1/4"



13-2212-18
18 cm/7"



Javid



13-2213-17
17.5 cm/7"



13-2213-18
18 cm/7"

Cardiovascular Instruments

Catheter Clamps
Katheter-Klemmen

Pinces cathéter
Abrazaderas catéter



13-2214-01
16 cm/6 1/4"
24 Charr

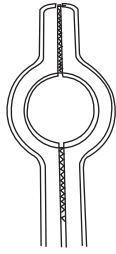

13-2214-02
16 cm/6 1/4"
26 Charr

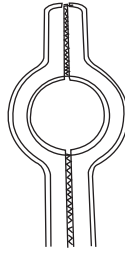

13-2214-03
20 cm/8"
28 Charr

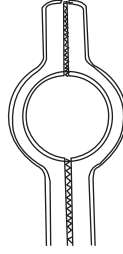

13-2214-04
20 cm/8"
30 Charr

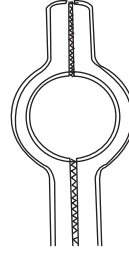

13-2214-05
20 cm/8"
32 Charr

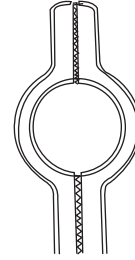

13-2214-07
20 cm/8"
36 Charr

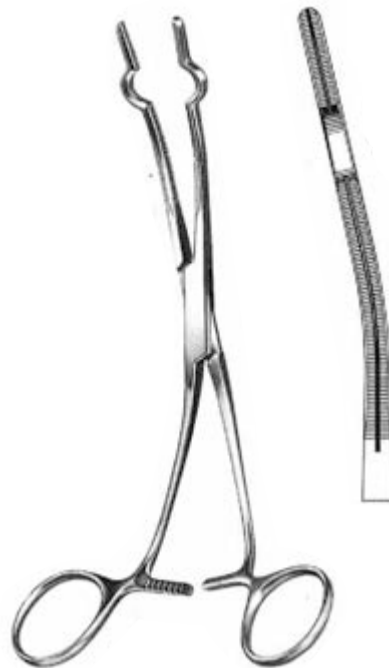

Cooley

Cardiovascular Instruments

Vascular Forceps
Vaskuläre Zange

Pince vasculaires
Pinzas vasculares



13



13-2215-16 = 16 cm/6 1/4"
13-2215-20 = 20 cm/8"
13-2215-24 = 24.5 cm/9 3/4"
13-2215-30 = 30 cm/11 3/4"

DeBakey
2.7mm



13-2216-16 = 16 cm/6 1/4"
13-2216-20 = 20 cm/8"
13-2216-24 = 24.5 cm/9 3/4"

DeBakey
1.5mm



13-2217-16 = 16 cm/6 1/4"
13-2217-20 = 20 cm/8"
13-2217-24 = 24.5 cm/9 3/4"
13-2217-30 = 30 cm/11 3/4"

DeBakey
2.5mm



13-2218-16 = 16 cm/6 1/4"
13-2218-20 = 19.5 cm/7 3/4"
13-2218-24 = 24.5 cm/9"
13-2218-30 = 29.5 cm/11 3/4"

DeBakey
2.0mm



13-2219-16 = 16 cm/6 1/4"
13-2219-20 = 20 cm/8"
13-2219-24 = 24.5 cm/9 3/4"
13-2219-30 = 30 cm/11 3/4"

DeBakey
3.5mm



13-2220-16 = 16 cm/6 1/4"
13-2220-20 = 20 cm/8"

DeBakey
2.0mm



Cardiovascular Instruments

Multi Purpose Vascular Clamps
Multi Purpose Gefäßklemmen

Pinces Multi Purpose vasculaires
Pinzas Multiuso vasculares

13

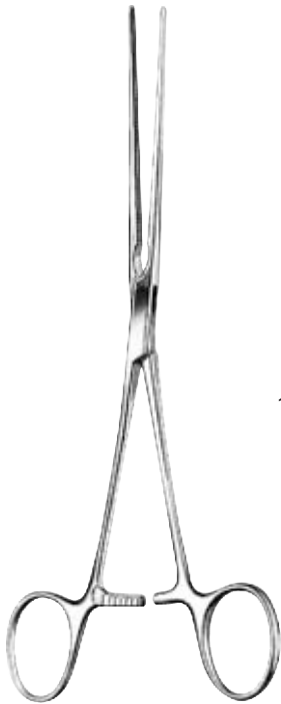

Bainbridge

13-2225-15
15 cm/6 "



13-2226-18
18.5 cm/7 1/4 "



Bainbridge

13-2227-15
15 cm/6 "



13-2228-18
18.5 cm/7 1/4 "



DeBakey

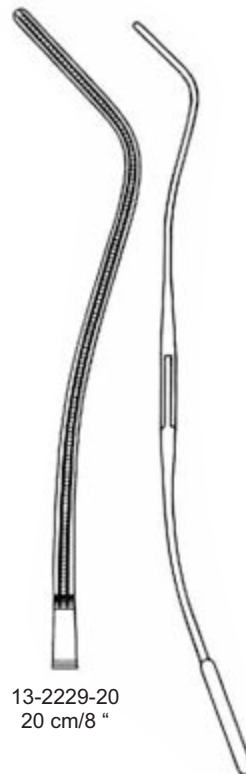

13-2229-20
20 cm/8 "

Cardiovascular Instruments

Peripheral Vascular Clamps
Peripheral Vascular Clamps

Clamps vasculaires périphériques
Pinzas vasculares periféricas



13

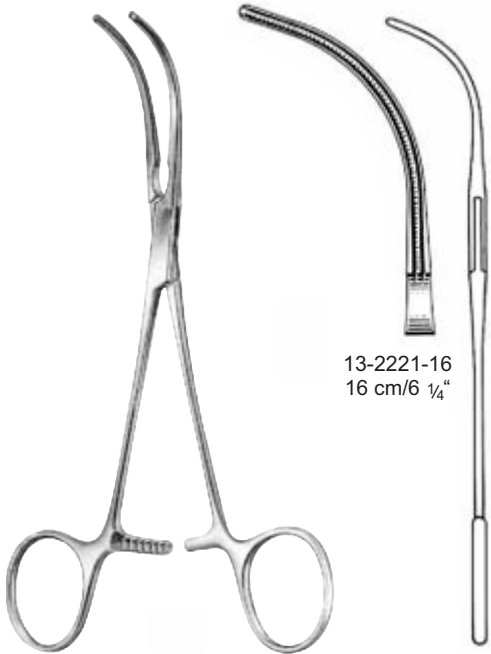

DeBakey

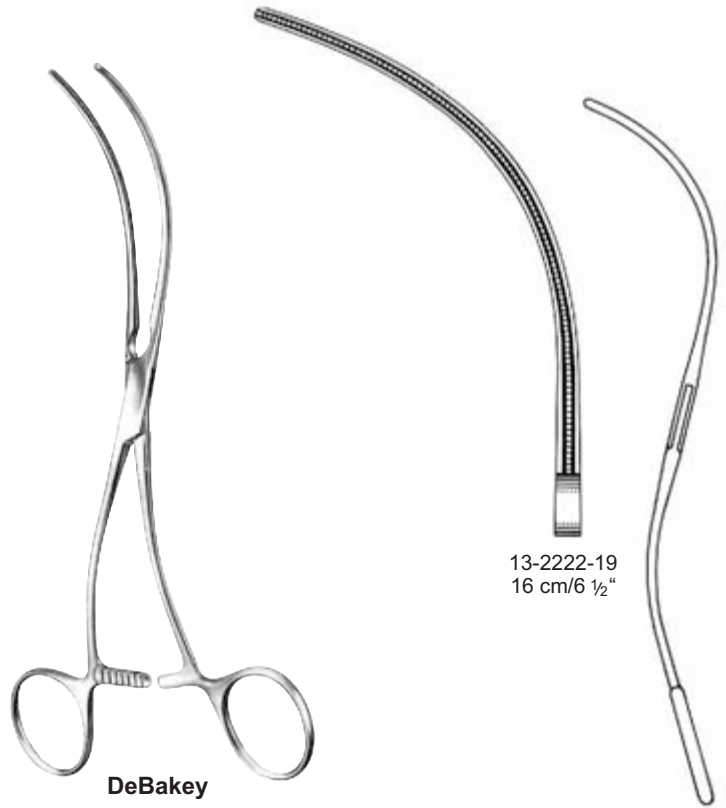

DeBakey



13-2223-18
18 cm/6 "

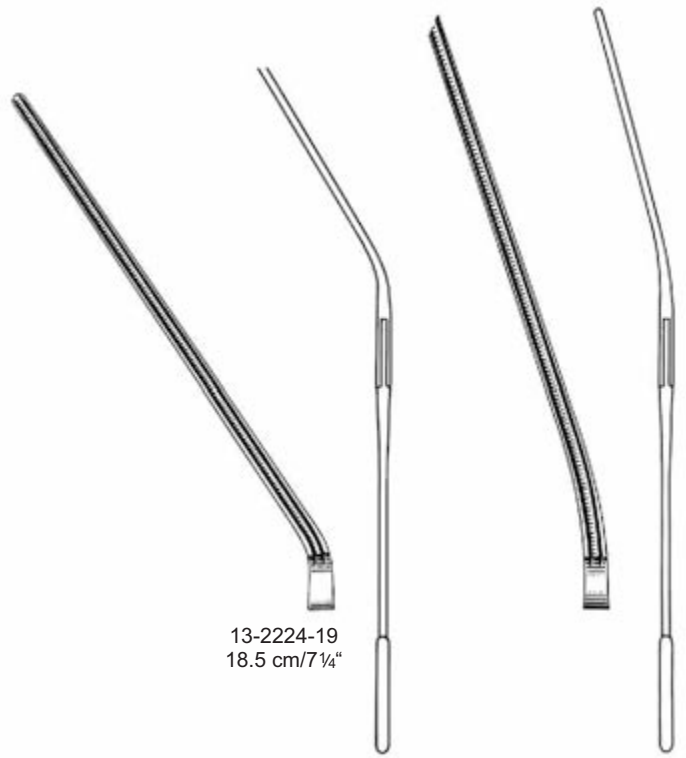

13-2224-19
18.5 cm/7 1/4"

Cardiovascular Instruments

Aortic Aneurysm Clamps
Aortenaneurysma Schellen

Pinces anévrisme aortique
Las abrazaderas de aneurismas aórticas

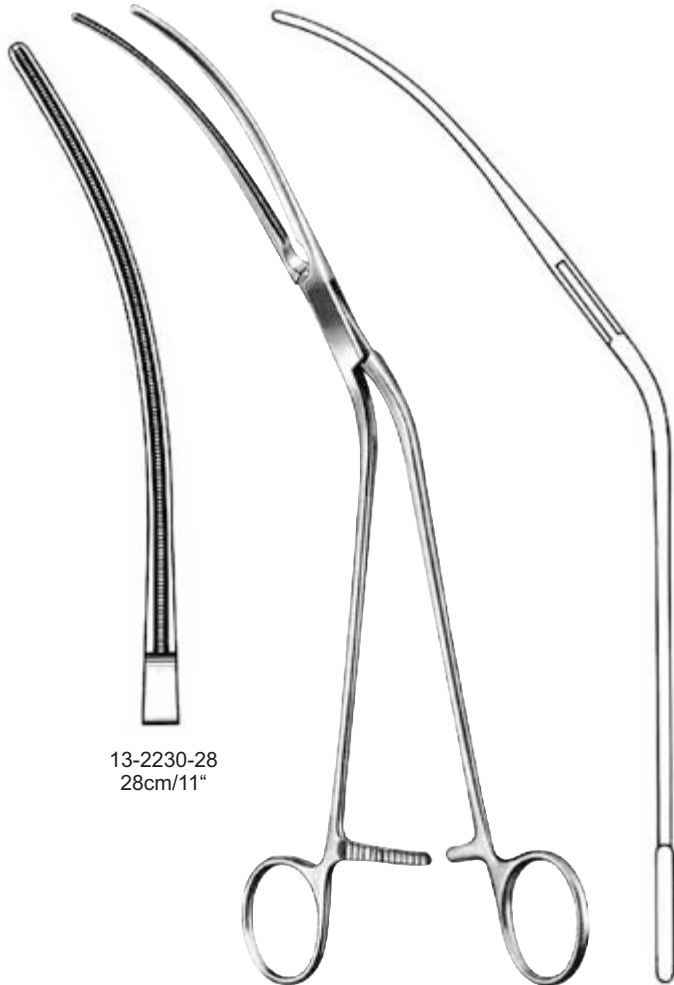

13-2230-28
28cm/11"

DeBakey

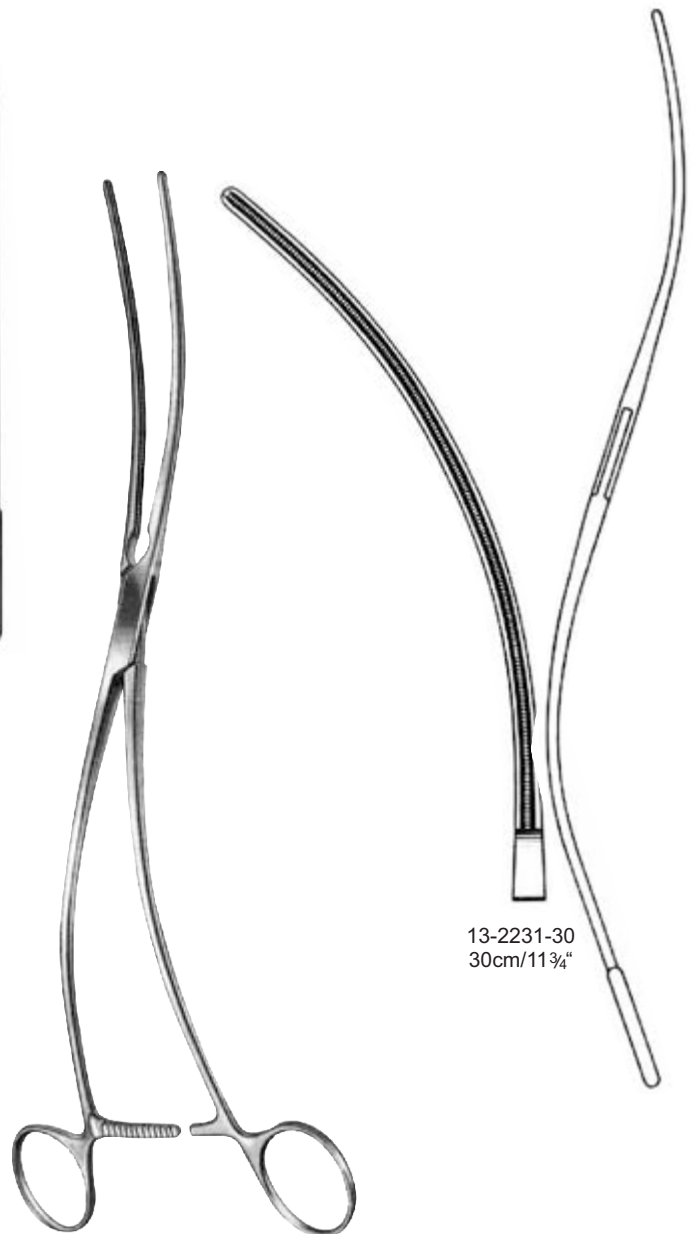

13-2231-30
30cm/11¾"

DeBakey

Cardiovascular Instruments

Aortic Aneurysm Clamps
Aortenaneurysma Schellen

Pinces anévrisme aortique
Las abrazaderas de aneurismas aórticas



13



DeBakey



13-2232-26
26cm/10 1/4"



13-2232-27
26cm/10 3/4"



13-2232-31
31cm/12 1/4"



13-2232-33
33cm/13"



Cardiovascular Instruments

Aortic Clamps, Ligature Forceps
Aorten-Klemmen, Ligaturklemmen

Clamps aortiques, pinces de ligature
Abrazaderas aórticas, pinzas de ligadura

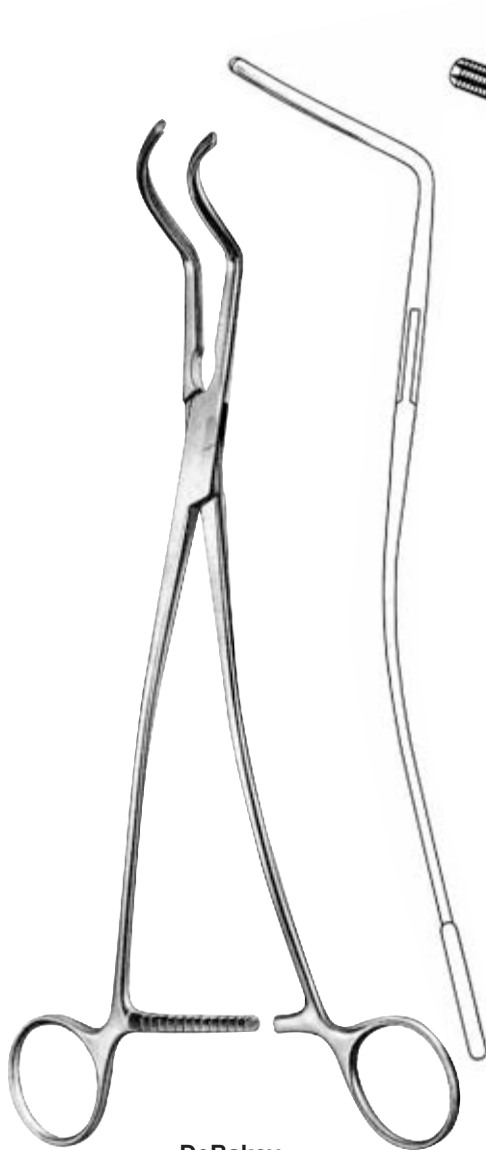

DeBakey
13-2233-27
27cm/10 3/4"



13-2234-24
24.5cm/9 3/4"

DeBakey

Cardiovascular Instruments

Aortic Clamps, Ligature Forceps
Aorten-Klemmen, Ligaturklemmen

Clamps aortiques, pinces de ligature
Abrazaderas aórticas, pinzas de ligadura



13

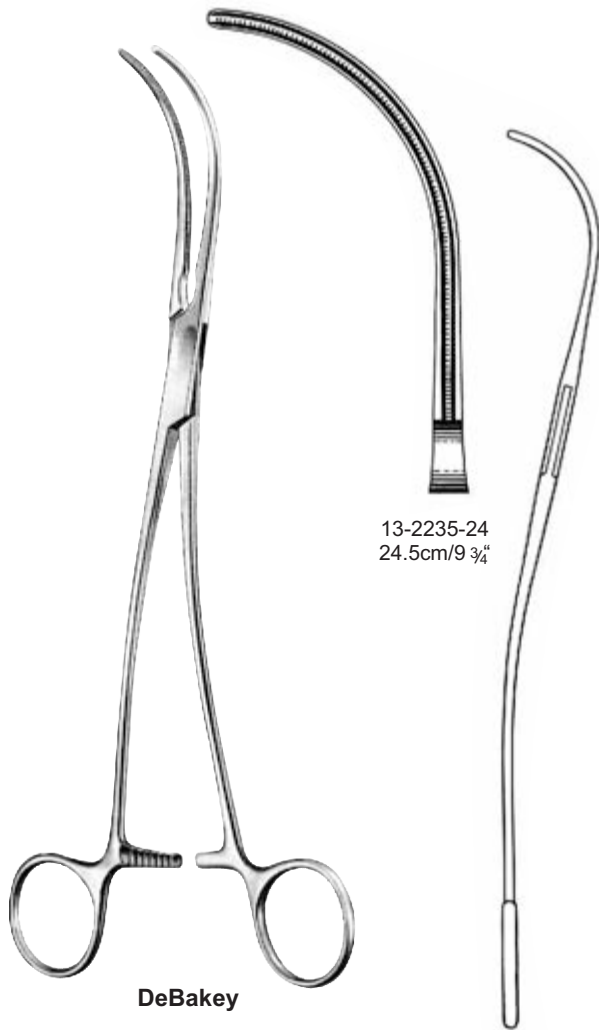

13-2235-24
24.5cm/9 3/4"

DeBakey



13-2236-25
27cm/10 1/2"

DeBakey

Cardiovascular Instruments

Aortic Clamps, Ligature Forceps
Aorten-Klemmen, Ligaturklemmen

Clamps aortiques, pinces de ligature
Abrazaderas aórticas, pinzas de ligadura

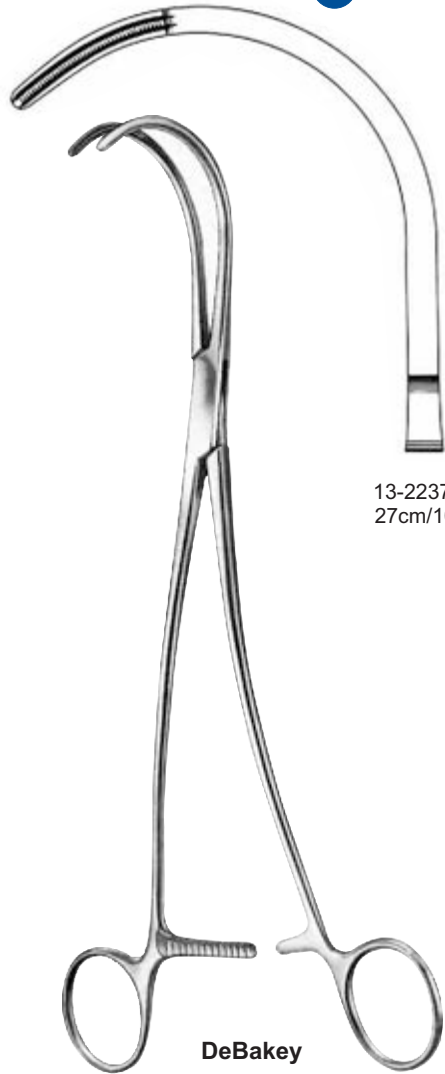

13-2237-26
27cm/10 1/2"

DeBakey



13-2238-01
24cm/9 1/2"



13-2238-02
24cm/9 1/2"



Weber

Cardiovascular Instruments

Auricle Clamps
Ohrmuschel Schellen

Pinces oreillette
Abrazaderas aurícula



13



Harken

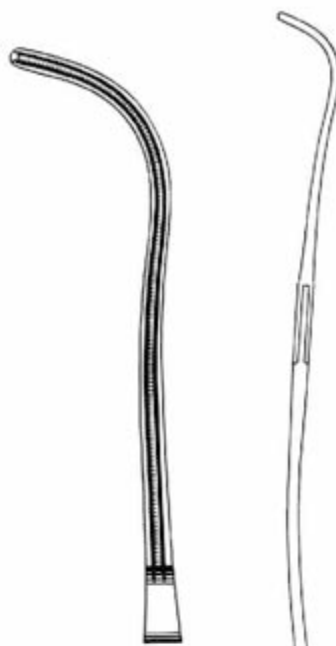

13-2239-01
24.5cm/9 3/4"

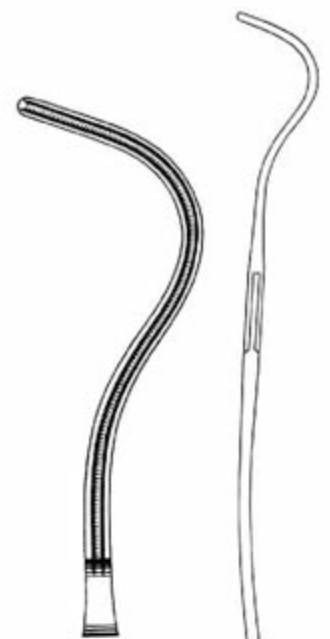

13-2239-02
24.5cm/9 1/2"



13-2239-03
24.5cm/9"



13-2239-04
24.5cm/9 1/4"

Cardiovascular Instruments

Tangential Occlusion Clamps
Tangentielle Occlusion Schellen

Pinces d'occlusion tangentielles
Abrazaderas tangenciales de oclusión



13-2240-22
22 cm/8 $\frac{3}{4}$ "



13-2240-26
26 cm/8 $\frac{1}{4}$ "



13-2240-25
25.5 cm/8 $\frac{1}{2}$ "



Satinsky



13-2240-27
27.5 cm/10 $\frac{3}{4}$ "



13-2240-28
28.5 cm/11 $\frac{1}{4}$ "



Cardiovascular Instruments

Bronchus Clamps
bronchus-Schellen

Pinces bronches
Abrazaderas de bronquios



13

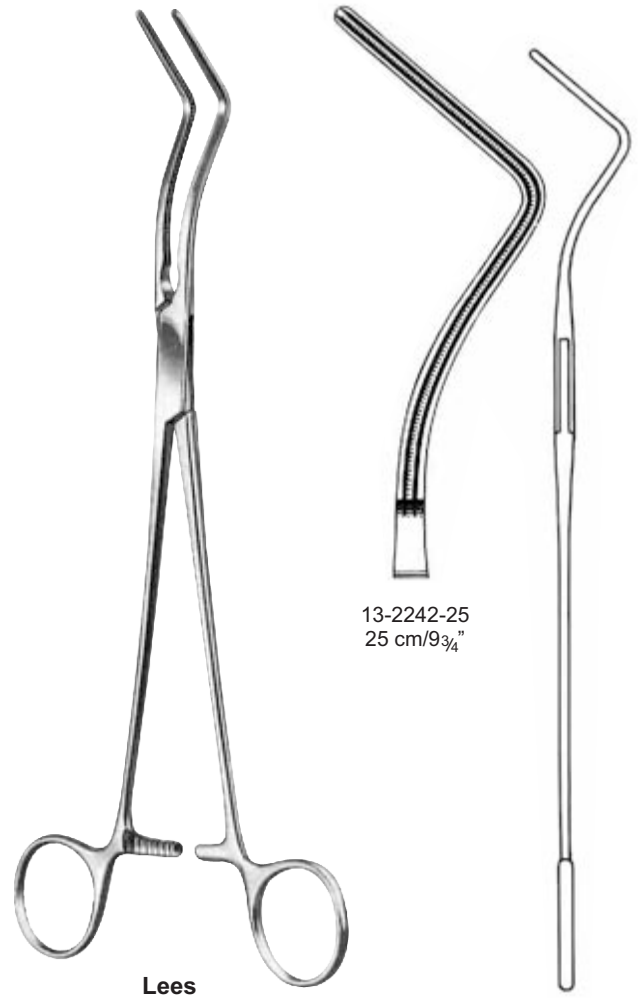



Cardiovascular Instruments

Anastomosis Clamps
Anastomose Schellen

Pinces anastomose
Abrazaderas anastomosis

13



Morris-DeBakey



13-2244-22
22.5 cm/8 3/4"



13-2244-22
22.5 cm/8 3/4"

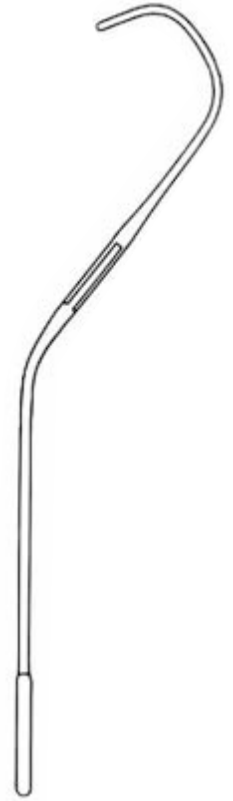

DeBakey



13-2245-16
16.5 cm/6 1/2"



Cardiovascular Instruments

Aortic Clamps
Aorten-Schellen

clamps aorticas
Abrazaderas aorticas



13



13-2243-16
16.5 cm/6 1/2"

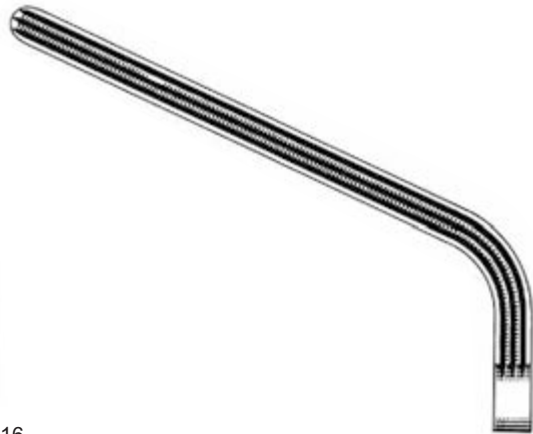

13-2243-20
20 cm/8 "



Morris-DeBakey

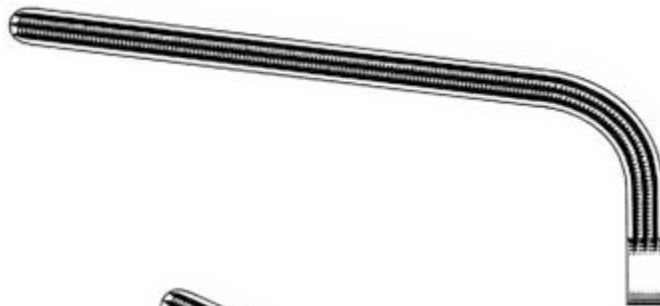

13-2243-24
24 cm/9 1/2"

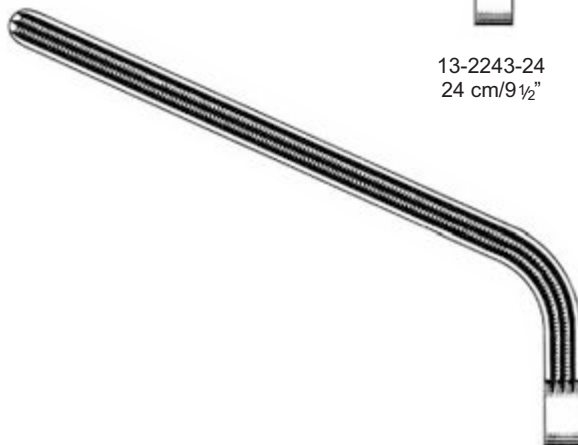

13-2243-26
26 cm/10 1/4"



Cardiovascular Instruments

Aneurysm Clamps
Aneurysma Schellen

Pinces anévrisme
Abrazaderas Aneurisma



DeBakey-Bahnson



13-2246-23
23.5 cm/9 1/4"



13-2246-24
24.5 cm/9 3/4"



13-2246-25
25.5 cm/10 "

Cardiovascular Instruments

Multi purpose Vascular Clamps
Mehrzweck Gefäßklemmen

Pinces multi usages vasculaires
Abrazaderas multipropósito vasculares



13



DeBakey

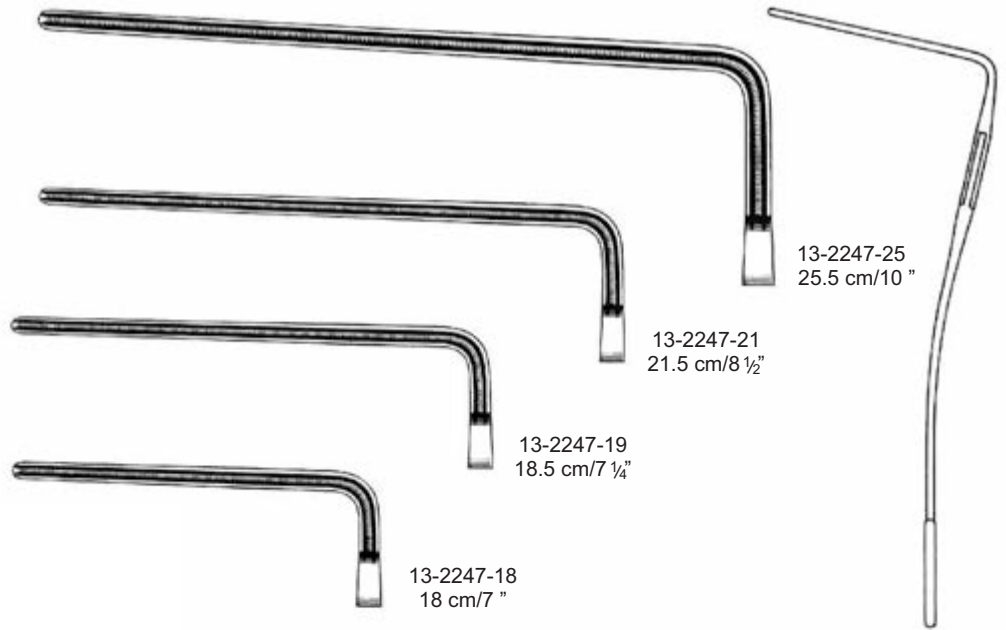

13-2247-25
25.5 cm/10 "

13-2247-21
21.5 cm/8 1/2"

13-2247-19
18.5 cm/7 1/4"

13-2247-18
18 cm/7 "



DeBakey

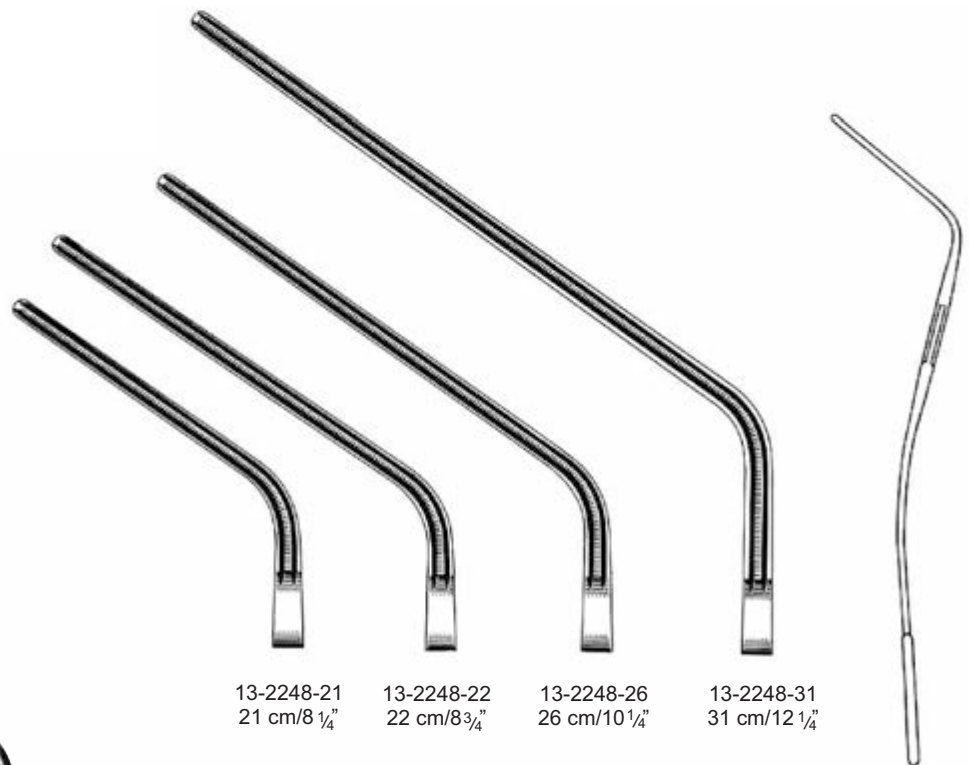

13-2248-21
21 cm/8 1/4"

13-2248-22
22 cm/8 3/4"

13-2248-26
26 cm/10 1/4"

13-2248-31
31 cm/12 1/4"

Cardiovascular Instruments

Multi purpose Vascular Clamps
Mehrzweck Gefäßklemmen

Pinces multi usages vasculaires
Abrazaderas multipropósito vasculares



Potts



13-2249-21
21.5 cm/8½"



13-2249-23
23.5 cm/9¼"



13-2249-27
27 cm/9¾"



13-2249-31
31 cm/12¼"



13-2250-21
21 cm/8¼"



13-2250-23
23 cm/9"



13-2250-26
26 cm/9¾"



13-2250-30
30.5 cm/12"

Cardiovascular Instruments

Haemosttic Forceps
Haemosttic Zange

Pince Haemoststic
Pinzas Haemoststic

13

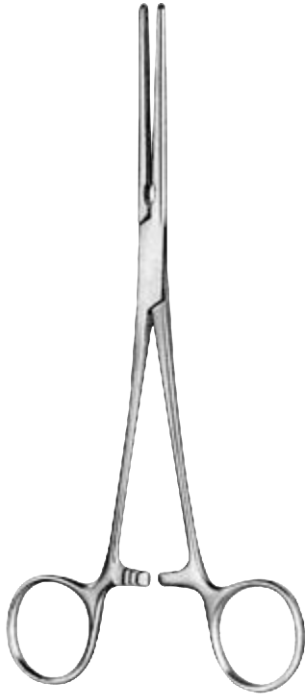

DeBakey-Pean



13-2251-14
14.5 cm/5 3/4"



13-2251-16
16.5 cm/5 1/4"



13-2251-18
18.5 cm/7 1/4"



13-2251-20
20.5 cm/8 "



DeBakey-Pean



13-2252-14
14.5 cm/5 3/4"



13-2252-16
16.5 cm/5 1/4"



13-2252-18
18.5 cm/7 1/4"



13-2252-20
20.5 cm/8 "

Cardiovascular Instruments

Multi purpose Vascular Clamps
Mehrzweck Gefäßklemmen

Pinces multi usages vasculaires
Abrazaderas multipropósito vasculares

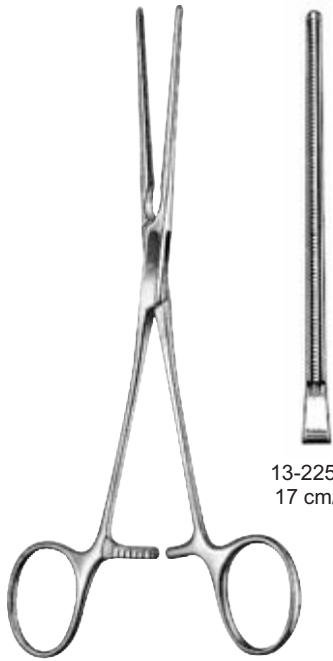

13-2253-17
17 cm/7 3/4"

DeBakey

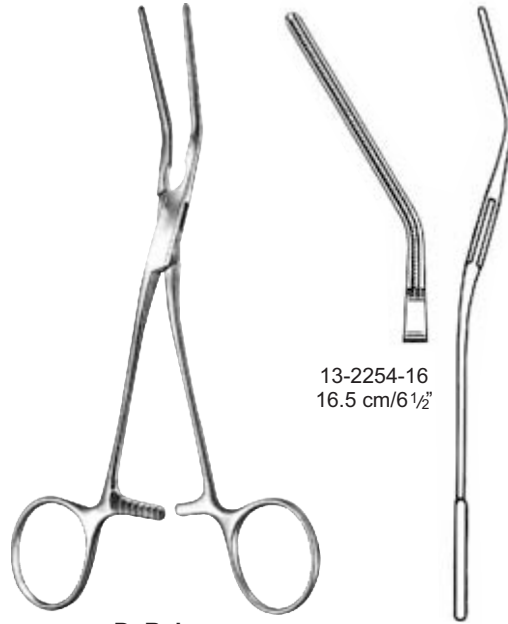

13-2254-16
16.5 cm/6 1/2"

DeBakey



13-2255-16
16 cm/6 1/2"

DeBakey



13-2256-14
14.5 cm/5 3/4"

DeBakey

Cardiovascular Instruments

Multi purpose Vascular Clamps
Mehrzweck Gefäßklemmen

Pinces multi usages vasculaires
Abrazaderas multipropósito vasculares



13

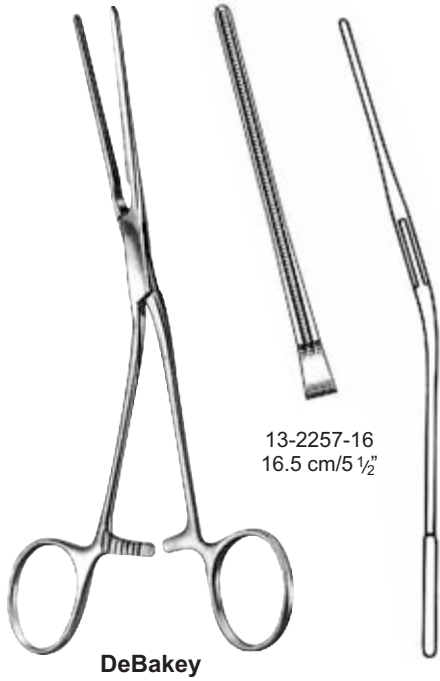

13-2257-16
16.5 cm/5 1/2"

DeBakey

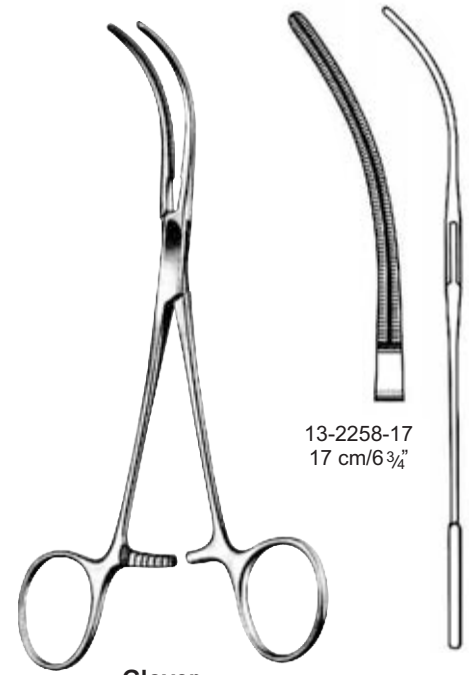

13-2258-17
17 cm/6 3/4"

Glover

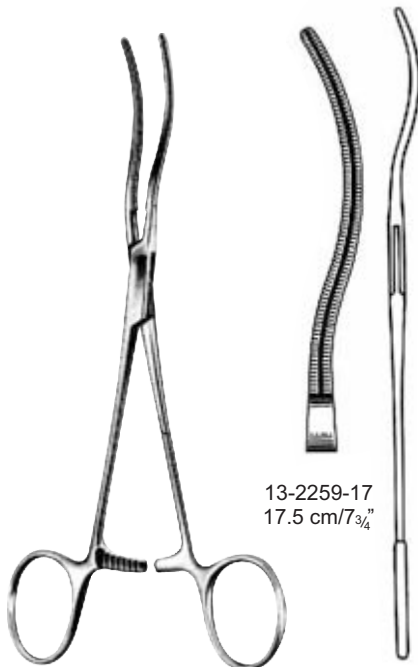

13-2259-17
17.5 cm/7 3/4"

Glover

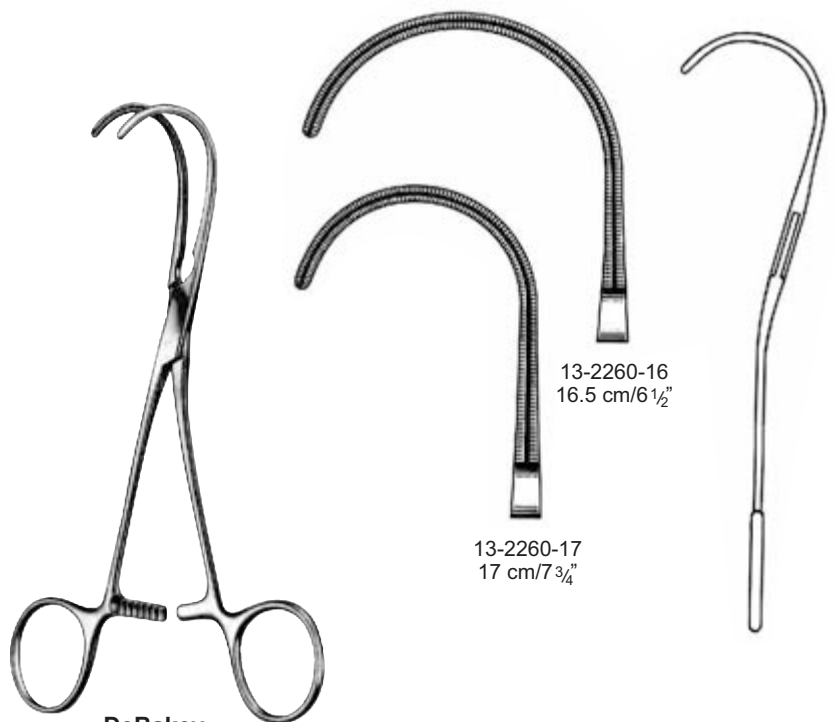

13-2260-16
16.5 cm/6 1/2"

13-2260-17
17 cm/7 3/4"

DeBakey

Cardiovascular Instruments

Anastomosis Clamps and Pediatric Vascular Clamps
Anastomose Klemmen und Pädiatrische Gefäßklemmen

Pinces anastomose et pédiatriques clamps vasculaires
Abrazaderas de anastomosis y pediátricos pinzas vasculares



Derra

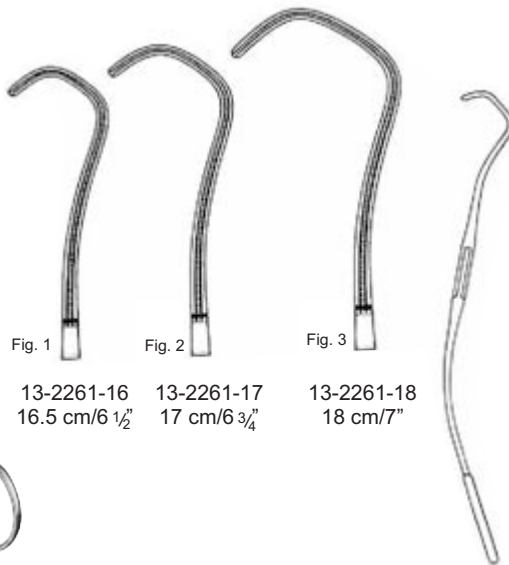

Fig. 1

13-2261-16
16.5 cm/6 1/2"

Fig. 2

13-2261-17
17 cm/6 3/4"

Fig. 3

13-2261-18
18 cm/7"



DeBakey-Beck

13-2262-17
17 cm/6 3/4"



DeBakey

13-2263-10
10 cm/4"

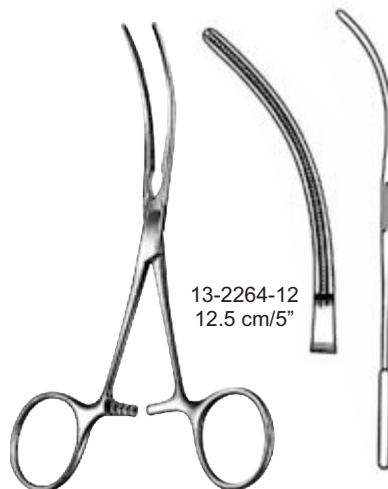

DeBakey

13-2264-12
12.5 cm/5"



13-2265-12
12 cm/5"

Cardiovascular Instruments

Pediatric Vascular Clamps
Pediatric Gefäßsklemmen

Pédiatriques clamps vasculaires
Pediátricos pinzas vasculares



13



DeBakey



13-2266-12
12.5 cm/5"



DeBakey

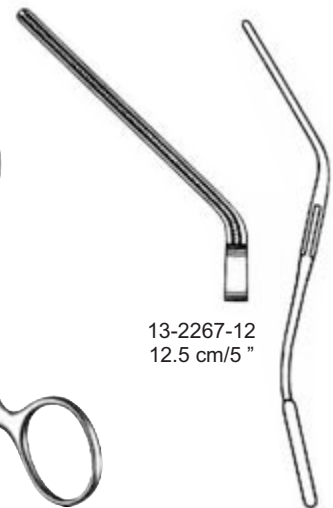

13-2267-12
12.5 cm/5"

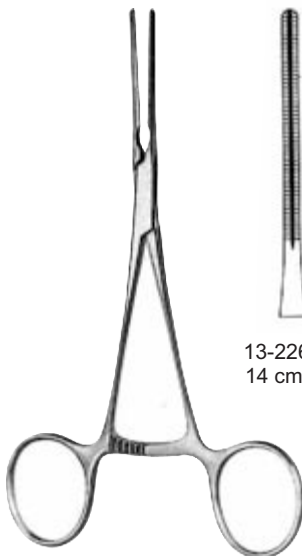

DeBakey



13-2268-01
14 cm/5 1/2"



13-2268-02
12.5 cm/5 3/4"



DeBakey



13-2269-03
12.5 cm/5 1/2"

Cardiovascular Instruments

Pediatric Vascular and Anastomosis Clamps
 Pediatric Vascular Anastomose und Schellen

Vasculaire pédiatrique et pinces Anastomose
 Vascular pediátrica y abrazaderas Anastomosis



13-2270-14
 14 cm/5 1/2"

Cooley



Cooley
 13-2271-14
 14 cm/5 1/2"

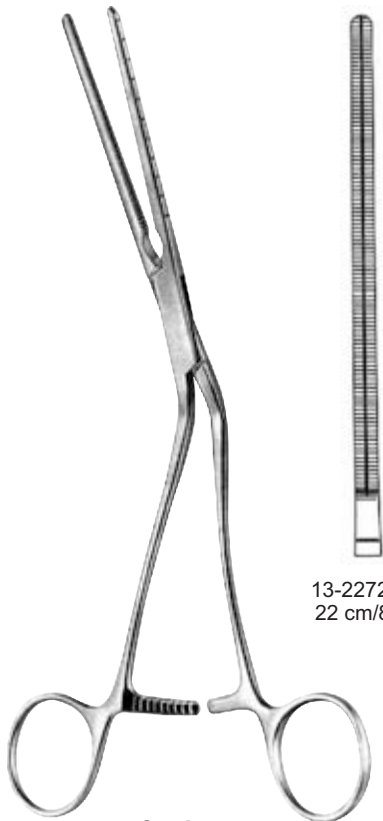

13-2272-22
 22 cm/8 3/4"

Cooley
 Iliac Clamp

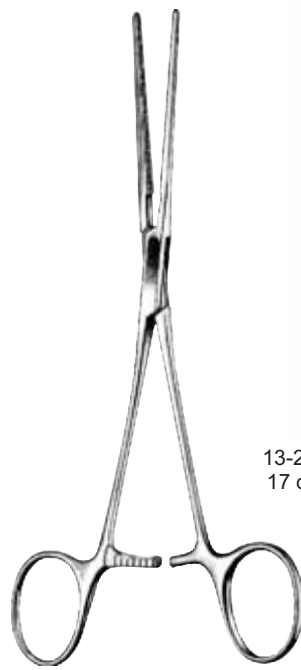

13-2273-17
 17 cm/6 3/4"

Cooley

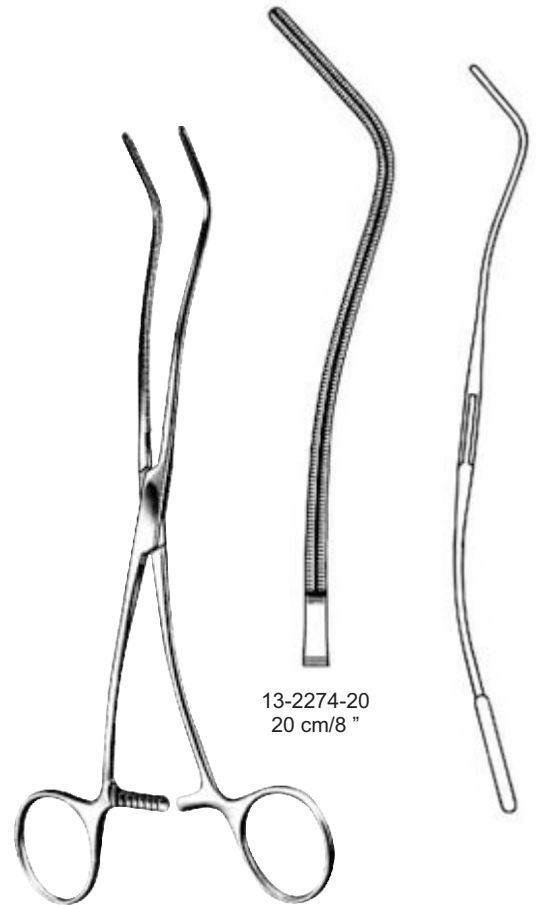

13-2274-20
 20 cm/8"

Cooley

Cardiovascular Instruments

Anastomosis Clamps, Multi purpose Vascular Clamps
Anastomose Klemmen, Mehrzweck Gefäßklemmen

Pinces Anastomose, colliers multi usages vasculaires
Abrazaderas, Abrazaderas anastomosis vasculares multipropósito



13



Cooley

13-2275-16
16cm/6 1/4"

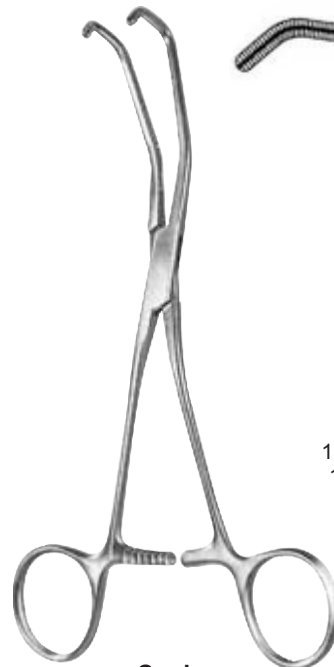

Cooley

13-2276-16
16cm/5 1/4"

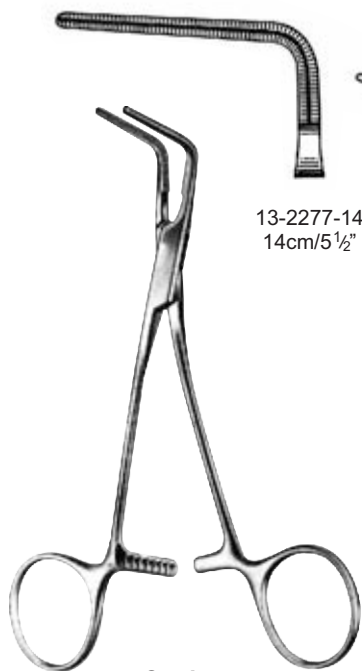

Cooley

13-2277-14
14cm/5 1/2"

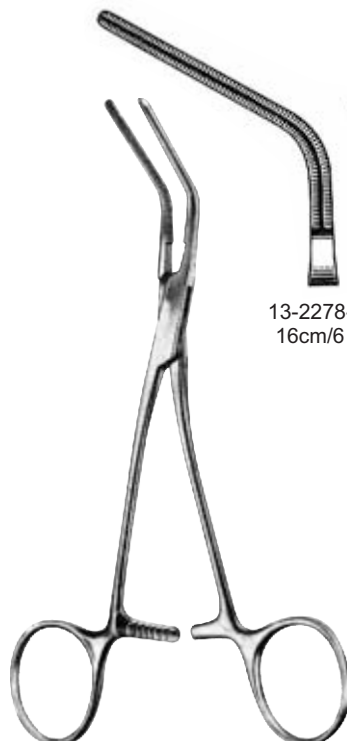

Cooley

13-2278-16
16cm/6 1/4"

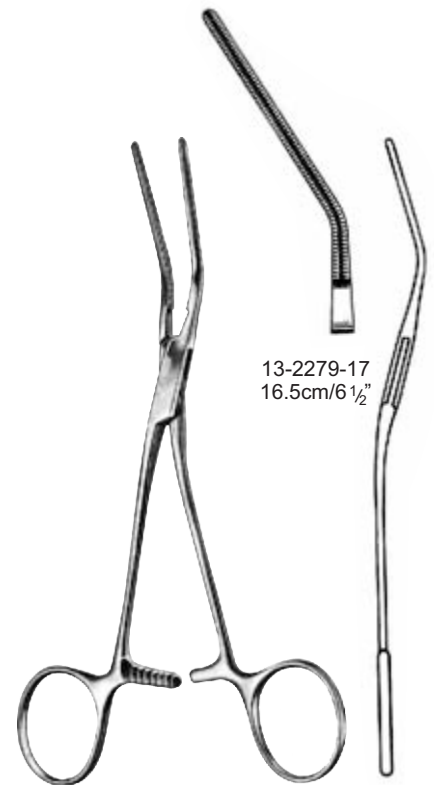

Cooley

13-2279-17
16.5cm/6 1/2"

Cardiovascular Instruments

Multi Purpose vascular Clamps
Multi Purpose Gefäßklemmen

Pinces Multi Purpose vasculaires
Pinzas Multiuso vasculares

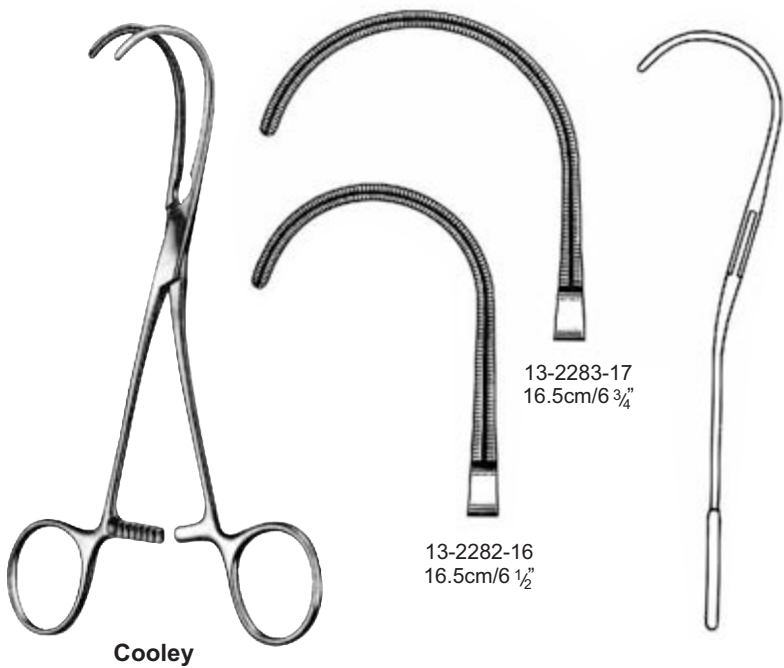

13-2283-17
16.5cm/6³/₄"

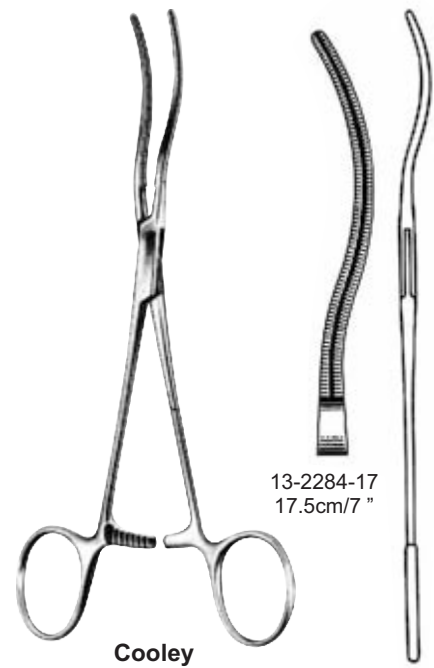

Cardiovascular Instruments

Multi Purpose vascular Clamps
Multi Purpose Gefäßklemmen

Pinces Multi Purpose vasculaires
Pinzas Multiuso vasculares



13

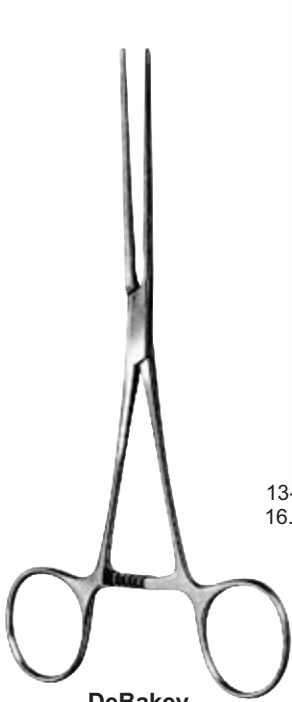

13-2285-16
16.5cm/7 1/2"

DeBakey



13-2286-16
16cm/7 1/4"

DeBakey

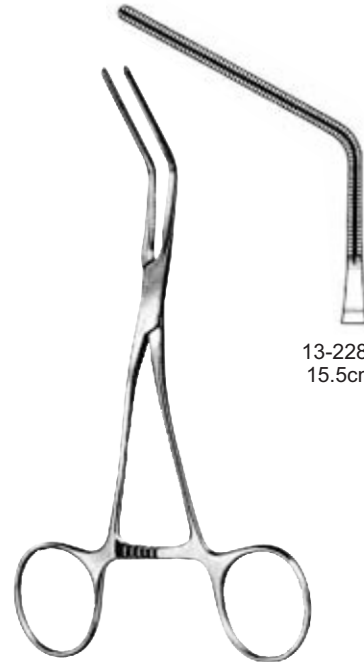

13-2287-16
15.5cm/6"

DeBakey



13-2288-16
15.5cm/6"

Cooley



13-2289-16
16cm/6"

Cooley

Cardiovascular Instruments

Neonatal and Pediatric Clamps
 Neonatologischen und pädiatrischen Schellen

Pinces néonatale et pédiatrique
 Abrazaderas neonatal y pediátrica

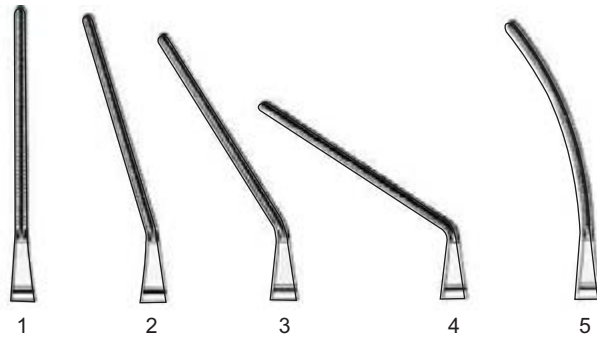

Fig.

1

2

3

4

5



Fig.

6

7

8

9

Fig.	Straight gerade droit recto
1	13-2290-01
2	13-2290-02
3	13-2290-03
4	13-2290-04
5	13-2290-05
6	13-2290-06
7	13-2290-07
8	13-2290-08
9	13-2290-09

Fig.	Angled Anglé incliné angular
1	13-2291-01
2	13-2291-02
3	13-2291-03
4	13-2291-04
5	13-2291-05
6	13-2291-06
7	13-2291-07
8	13-2291-08
9	13-2291-09

Fig.	Curved Gebogene courbé Curvo
1	13-2292-01
2	13-2292-02
3	13-2292-03
4	13-2292-04
5	13-2292-05
6	13-2292-06
7	13-2292-07
8	13-2292-08
9	13-2292-09

Cardiovascular Instruments

Neonatal Vascular Clamps
Neonatal Gefäßklemmen

Néonatales clamps vasculaires
Neonatales pinzas vasculares



13



Castaneda



13-2293-01
12cm/5"



13-2293-02
11.5cm/4½"

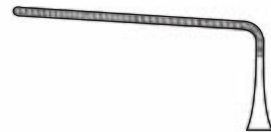

13-2293-03
11cm/4¼"



13-2294-01
11.5cm/4½"

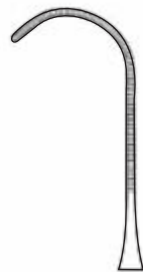

13-2294-02
12cm/4¾"

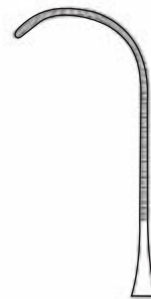

13-2294-03
12cm/4¾"



13-2294-04
12cm/4¾"

Cardiovascular Instruments

Intima Spatula, Vascular Dissectors
Lingerie Spachtel-, Gefäß-Dissektoren

Spatule intime, dissecteurs vasculaires
Intima Spatula, Vascular disector

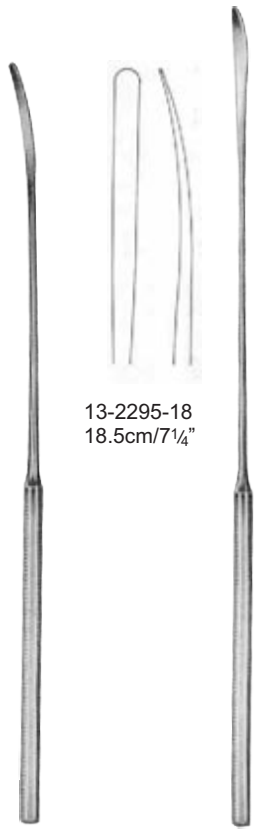

13-2295-18
18.5cm/7¼"

Intima Spatula

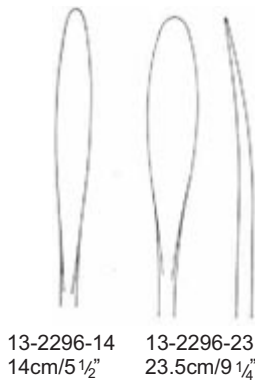

13-2296-14
14cm/5½"

13-2296-23
23.5cm/9¼"



5 mm

2.5 mm Ø

Robb
13-2297-01
24cm/9½"
Fig. 1



4 mm

2.0 mm Ø

Robb
13-2297-02
24cm/9½"
Fig.2



3 mm

2 mm

1.5 mm Ø

1.0 mm Ø

Robb
13-2297-03
24cm/9½"
Fig.3

Robb
13-2297-04
24cm/9½"
Fig.4

Cardiovascular Instruments

Nerve Hooklets, Toruniqetes
Nerve Håkchen, Toruniqetes

Petits crochets nerveuses, Toruniqetes
Ganchillos nerviosas, Toruniqetes



13



13-2298-20
20cm/8"

Crile



13-2299-20
20.5cm/8"

Crile



13-2300-01
26cm/10 1/4"
1.5 mm



13-2300-02
26cm/10 1/4"
2.0 mm



13-2300-03
26cm/10 1/4"
2.5 mm



13-2300-04
26cm/10 1/4"
3.0 mm

Ligature Catchers



13-2301-27
26cm/10 3/4"
3.0 mm \varnothing

13-2301-30
30.5cm/12"
6.4 mm \varnothing

Rumel-Belmont

Cardiovascular Instruments

Aortic Dilators
Aorten-Dilatatoren

Dilatateurs aortiques
dilataores aórticos

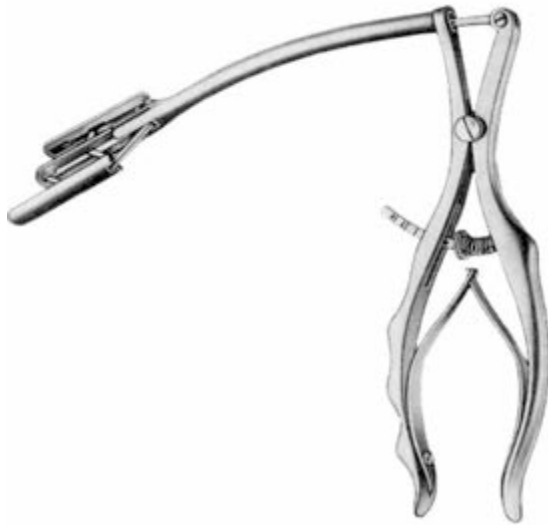

Cooley
13-2302-00



Gerbode
13-2303-00

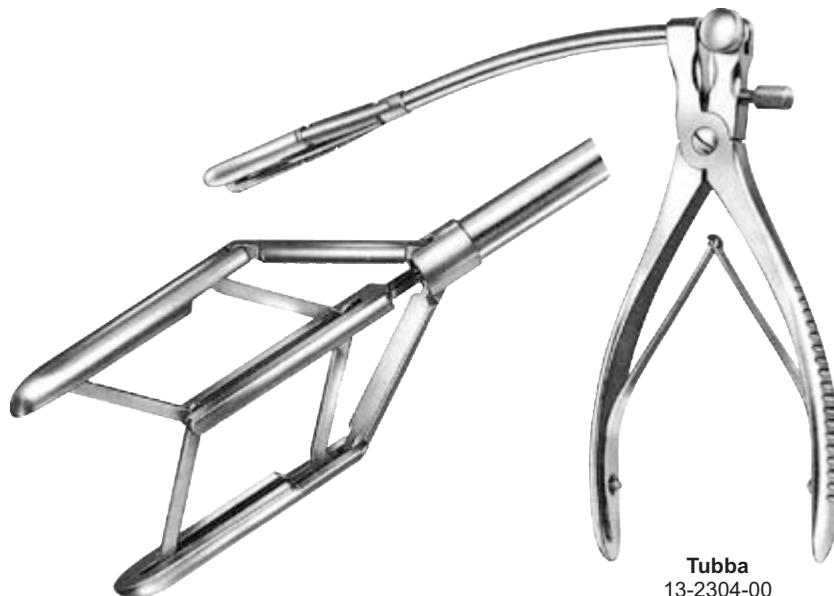

Tubba
13-2304-00

Neuro and Laminectomy Instruments

Instrument for Craniotomy Opening
Instrument für Craniotomy Eröffnung

Instrument concernant l'ouverture Craniotomy
Instrument para la Apertura de Craniotomy



14



Gigli
14-2305-00

Wire Saws
Seilsägen
Scies à fil
Sierras de cable

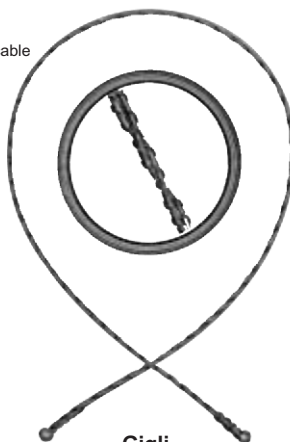

Gigli
14-2306-30 30 cm/12"
14-2306-40 40 cm/16"
14-2306-50 50 cm/20"

Conductors
Leiter
conducteurs
conductores



Martel
14-2307-33
33 cm/13"



Dahlgren
14-2308-20
20 cm/8"

With 2 Extra Hooks
Mit 2 Extra Haken
Avec 2 crochets supplémentaires
Con 2 ganchos adicionales

Skull Cutting Forceps
Schädel Cutting Forceps
Pince coupe de crâne
Pinzas de corte del cráneo



De Vilbiss
14-2309-21
21 cm/8 1/4"

With 1 Hook Each
Mit 1 pro Haken
Avec 1 crochet Chaque
Con un gancho Cada

Neuro and Laminectomy Instruments

Cervical Traction Tongs
Halswirbeltraktionsgerät Zange

Pince de traction cervicale
Pinzas de tracción cervical



14-2310-00

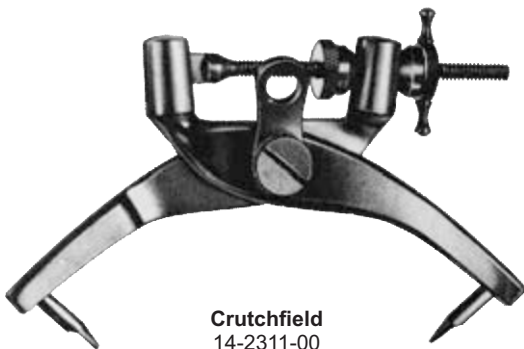

Crutchfield
14-2311-00

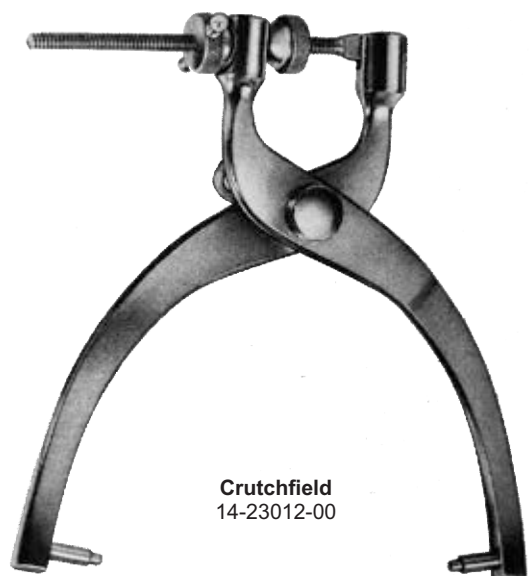

Crutchfield
14-23012-00

Neuro and Laminectomy Instruments

Instrumentns for Brain Suture
Instrumentns für Brain Suture

Instrumentns pour Suture cerveau
Instrumentns para la sutura del cerebro



14

Applying and Removing Forceps
Auftragen und Entfernen von Pinzetten
Application et suppression forceps
La aplicación de fórceps y extracción

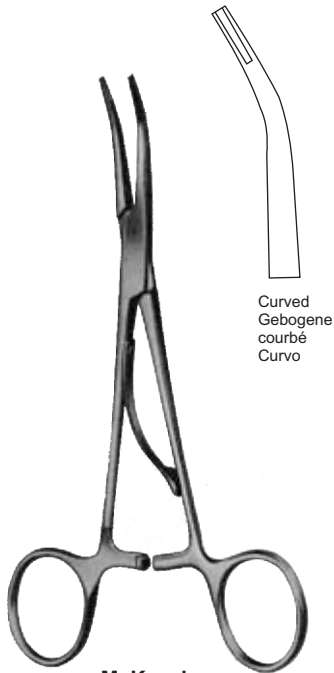

Curved
Gebogene
courbé
Curvo

McKenzie
14-2313-15 15 cm/6"
14-2313-19 19 cm/7½"



Straight
gerade
droit
recto

McKenzie
14-2314-15 15 cm/6"
14-2314-19 19 cm/7 "



Raney
14-2315-00
16 cm/6¼"



Olivecrona-Tonnis
14-2316-14

Neuro and Laminectomy Instruments

Dura Dissectors
harte Dissektoren

dissecteurs durs
dura disector

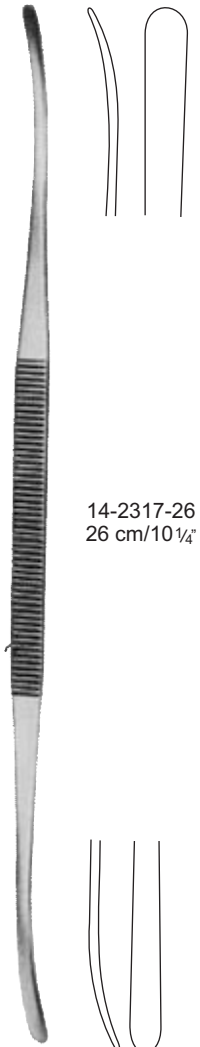

14-2317-26
26 cm/10¼"

Toennis

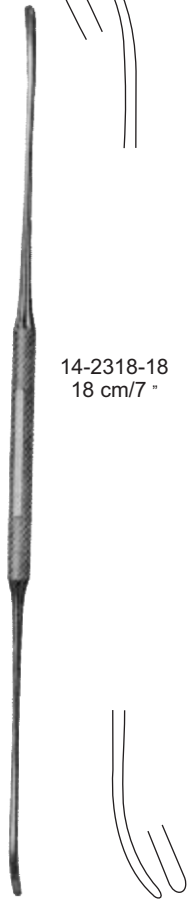

14-2318-18
18 cm/7 "

Olivecrona

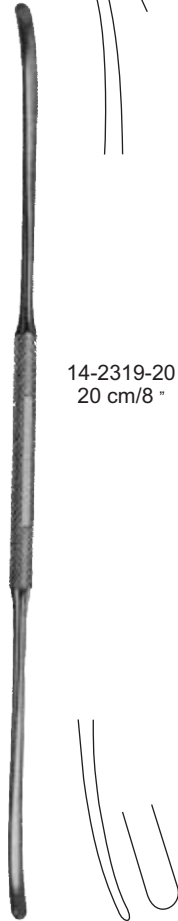

14-2319-20
20 cm/8 "

Olivecrona



14-2320-21
20.5 cm/8 "



Sachs



14-2321-21
21.5 cm/8½"

Milligan

Neuro and Laminectomy Instruments

Dura Dissectors
harte Dissektoren

dissecteurs durs
dura disector

14

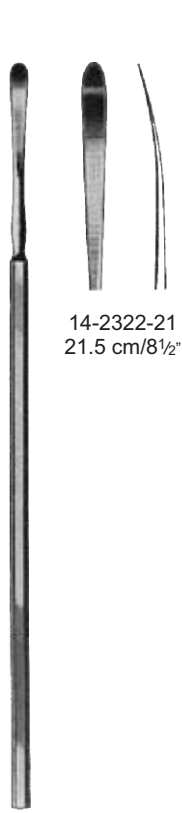

Davis

14-2322-21
21.5 cm/8½"

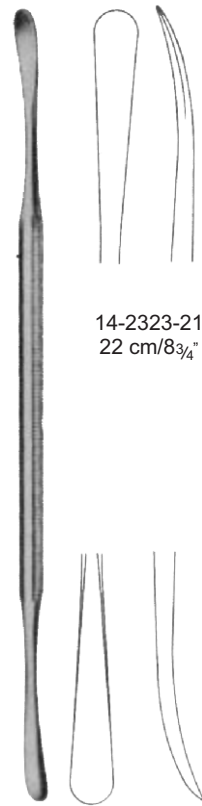

14-2323-21
22 cm/8¾"



Penfield

14-2324-01
17.5 cm/7"
Fig. 1

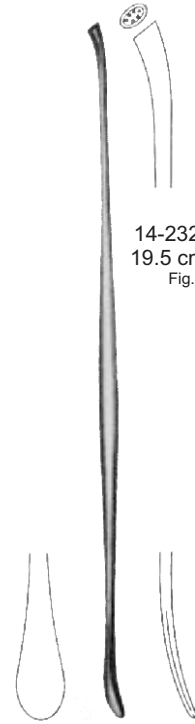

Penfield

14-2325-02
19.5 cm/7¾"
Fig. 2

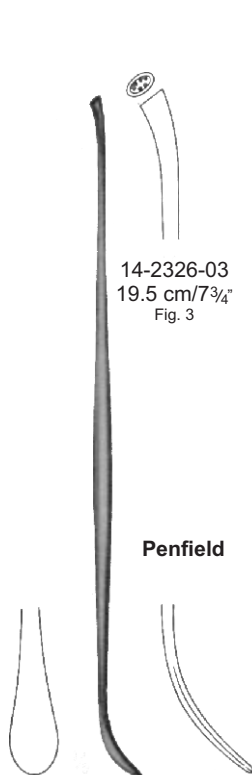

Penfield

14-2326-03
19.5 cm/7¾"
Fig. 3



Penfield

14-2327-04
20.5 cm/8"
Fig. 4

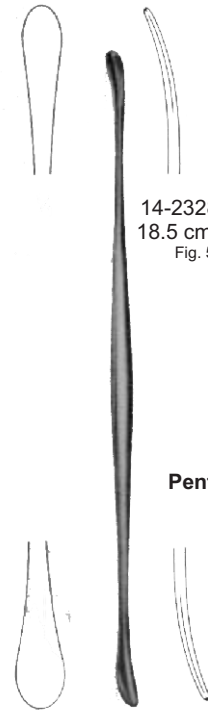

Penfield

14-2328-05
18.5 cm/7¼"
Fig. 5

Neuro and Laminectomy Instruments

Dura Dissectors, Nerve Root Retractors and Brain Spatulas

Dissecteurs Dura, Rétracteurs racine nerveuse et Brain Spatules

Dura Dissektoren, Nervenwurzel Retraktoren und Brain Spatel

Dura disectores, Retractores raíz del nervio y Espátulas cerebrales

14

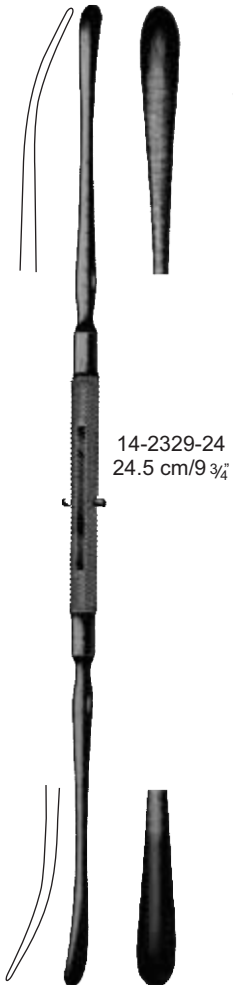

14-2329-24
24.5 cm/9 3/4"



14-2330-21
21.5 cm/8 1/2"



14-2331-18
18 cm/7"



14-2332-11
11 cm/4 1/4"

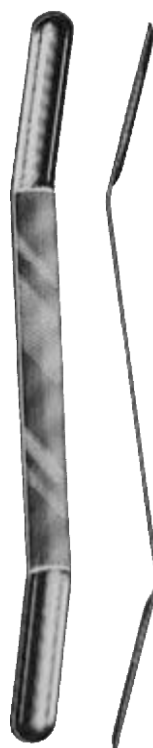

Upper end

Lower end

Concave
14-2333-01
14-2333-02
14-2333-03
14-2333-04

mm
7
11
15
18

mm
9
13
18
22

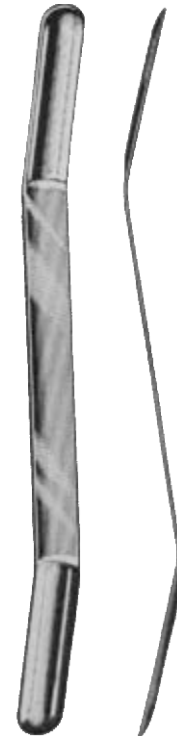

Convex
14-2334-01
14-2334-02
14-2334-03
14-2334-04

Olivecrona
18 cm/7"
Width of Spatulas
Breite Spatel
Largeur des Spatules
Ancho de espátulas

Neuro and Laminectomy Instruments

Nerve Root Retractors
Nervenwurzel Retraktoren

Rétracteurs des racines nerveuses
Los retractoros de las raíces nerviosas



14



14-2335-23
23.5 cm/9 1/4"

scoville



14-2336-24
23.5 cm/9 1/4"

Holsher

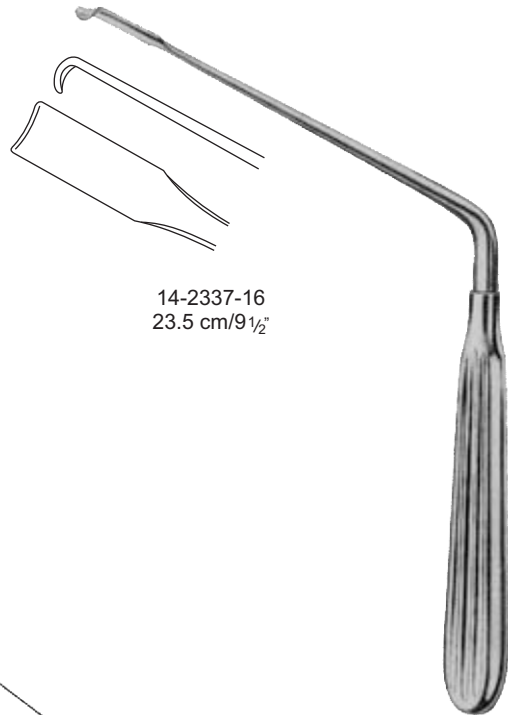

14-2337-16
23.5 cm/9 1/2"

Scoviller

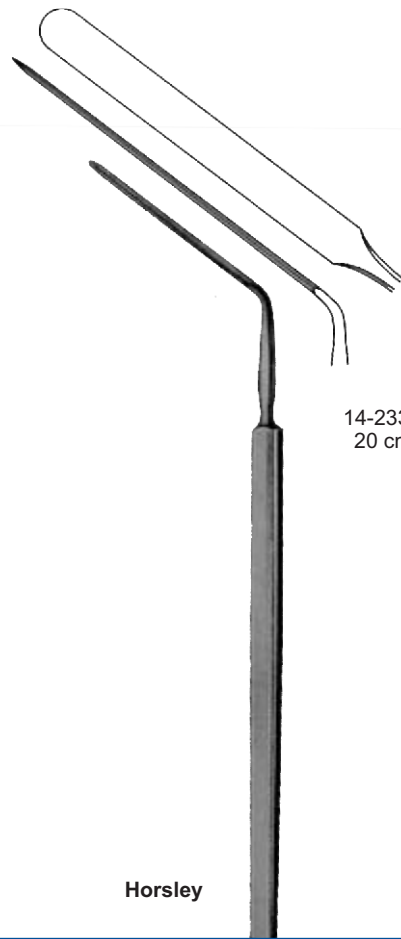

14-2338-20
20 cm/8 "

Horsley

Neuro and Laminectomy Instruments

Brain and Elevators
Gehirn und Aufzüge

Cerveau et Ascenseurs
Cerebro y Elevadores



20 cm/8"
14 mm 14-2339-14
17 mm 14-2339-17
20 mm 14-2339-20

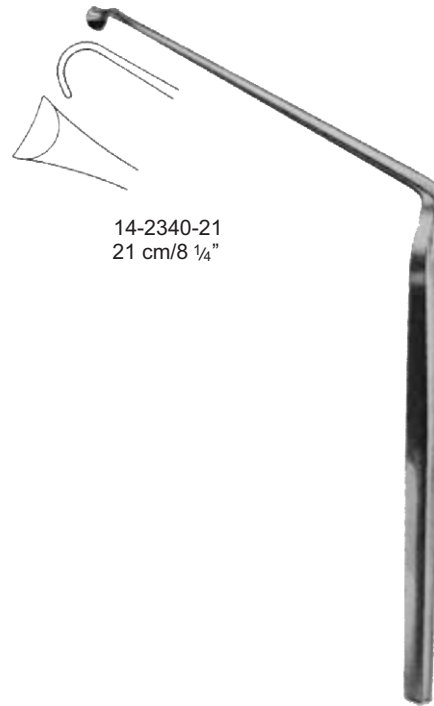

14-2340-21
21 cm/8 1/4"



14-2341-21
21 cm/8 1/4"

Sachs

Neuro and Laminectomy Instruments

Nerve Hooks
Nerve Haken

Crochets nerveuses
Ganchos nerviosas



14

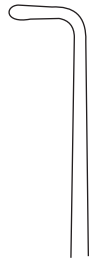

14-2342-26
26.5 cm/10½"



Groningen



14-2343-26
26.5 cm/10½"



Smithwick



14-2346-17
17 cm/6¾"



Cushing



14-2344-19
19 cm/7½"
Fig. 1

14-2344-28
28 cm/11"
Fig. 2



Cushing

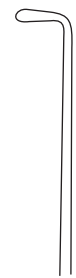

14-2345-19
19.5 cm/7 "
Fig. 1

14-2345-28
28 cm/11"
Fig. 2



14-2346-21
21 cm/8¼"



Dandy



14-2347-20
20 cm/8 "

Neuro and Laminectomy Instruments

Dura Knives, Dura Hooks
Messer Dura, Dura Haken

Couteaux Dura Dura, les crochets
Dura Dura cuchillos, ganchos

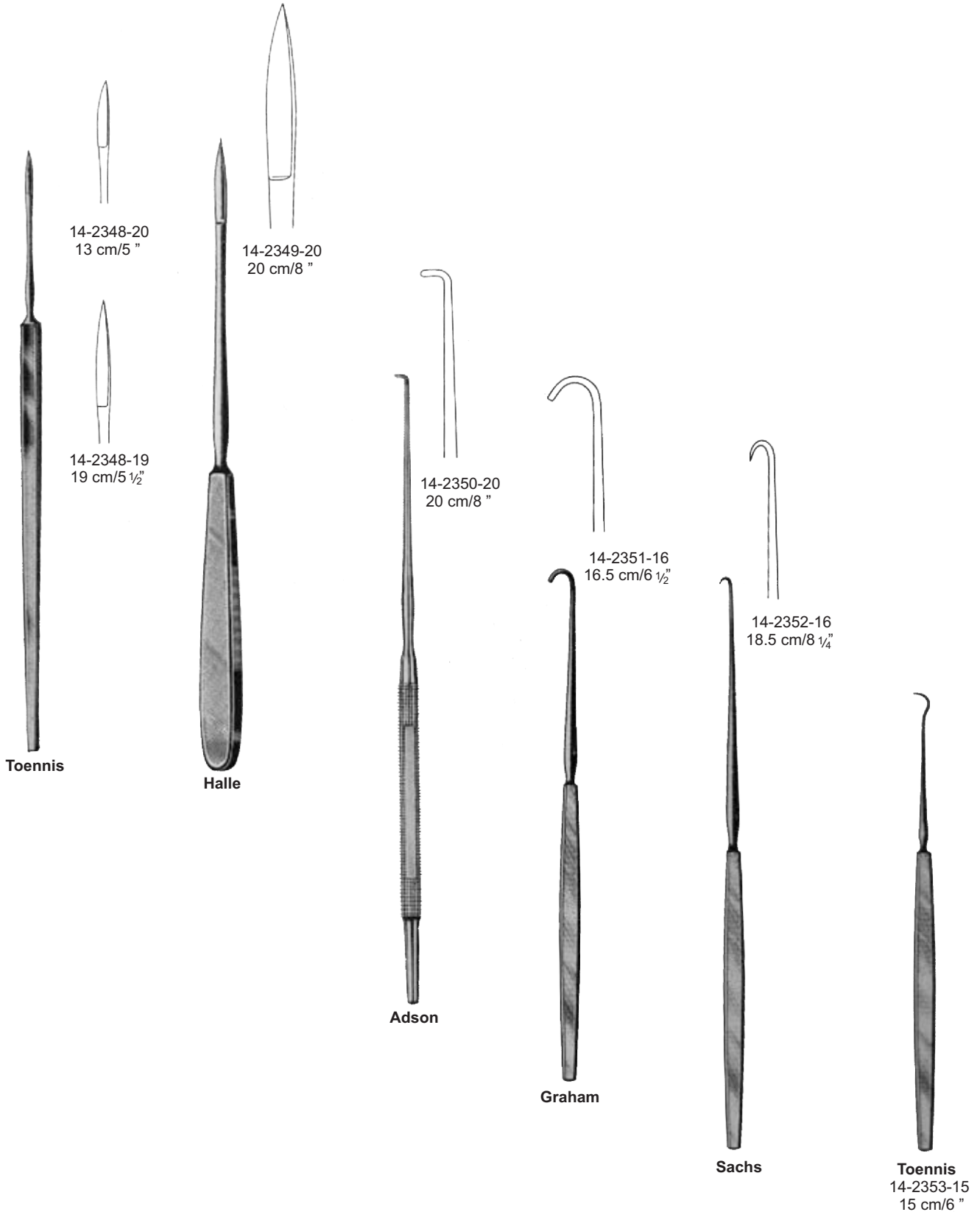

Neuro and Laminectomy Instruments

Blades for Lamina Spreaders
Klingen für Lamina Spreader

Lames pour Epondage Lamina
Cuchillas para Esparcidores Lamina

14

Lateral
seitlich
latérale
lateral



mm
14-2354-40 40 x 20
14-2354-45 45 x 20
14-2354-50 50 x 20
14-2354-55 55 x 20
14-2354-60 60 x 20



mm
14-2355-40 40 x 20
14-2355-45 45 x 20
14-2355-50 50 x 20
14-2355-55 55 x 20
14-2355-60 60 x 20



mm
14-2356-50 50 x 25
14-2356-60 60 x 25
Blunt Blades, For Taking
stumpfen Klingen, für die Aufnahme
Lames émoussées, pour prendre
Las cuchillas romas, para tomar

Medial
médian
medio



mm
14-2357-40 40 x 20
14-2357-45 45 x 20
14-2357-50 50 x 20
14-2357-55 55 x 20
14-2357-60 60 x 20

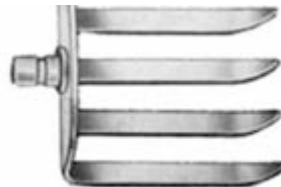

mm
14-2358-35 35 x 52
14-2358-40 40 x 52
14-2358-45 45 x 52
14-2358-50 50 x 52
14-2358-55 55 x 52
14-2358-60 60 x 52
14-2358-65 65 x 52
14-2358-70 70 x 52



mm
14-2359-35 35 x 37
14-2359-40 40 x 37
14-2359-45 45 x 37
14-2359-50 50 x 37
14-2359-55 55 x 37
14-2359-60 60 x 37
14-2359-65 65 x 37
14-2359-70 70 x 37



mm
14-2360-35 35 x 22
14-2360-40 40 x 22
14-2360-45 45 x 22
14-2360-50 50 x 22
14-2360-55 55 x 22
14-2360-60 60 x 22
14-2360-65 65 x 22
14-2360-70 70 x 22



mm
14-2361-50 50

Hook



mm
14-2362-70

Neuro and Laminectomy Instruments

Lamina Spreaders
Lamina Spreader

Epan dage lamina
Separadores de Lamina



Retractor Only
Retractor Nur
Seulement écarteur
Sólo Retractor

14-2363-01
12 cm/4¾"

Caspar
14-2363-00
14-2364-40
14-2365 -40

Retractor Complete With 1 Blade Each
Retractor komplett mit 1 Klinge Jeder
Écarteur complet avec Chaque lame 1
Retractor completo con Cada una hoja

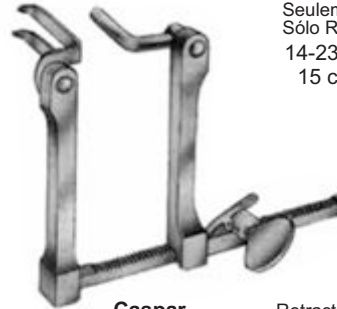

Retractor Only
Retractor Nur
Seulement écarteur
Sólo Retractor

14-2366-01
15 cm/6"

Caspar
14-2366-00
14-2367-40
14-2368-50

Retractor Complete With 1 Blade Each
Retractor komplett mit 1 Klinge Jeder
Écarteur complet avec Chaque lame 1
Retractor completo con Cada una hoja

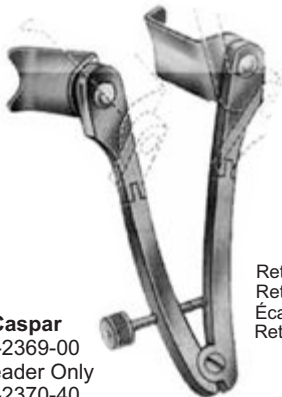

Spreader Only
Spreader Nur
épan deur seulement
Sólo Spreader
14-2369-01

Caspar
14-2369-00
Spreader Only
14-2370-40
14-2371-40

Retractor Complete With 1 Blade Each
Retractor komplett mit 1 Klinge Jeder
Écarteur complet avec Chaque lame 1
Retractor completo con Cada una hoja



Spreader Only
Spreader Nur
épan deur seulement
Sólo Spreader
14-2372-01

Caspar
14-2372-00

Retractor Only
Retractor Nur
Seulement écarteur
Sólo Retractor

Spreader Complete With 1 Blade Each
Spreader komplett mit 1 Klinge Jeder
Épan deur complet avec 1 Lame Chaque
Spreader completo con una cuchilla Cada

14-2373-45
14-2374-60

Retractor Only
Retractor Nur
Seulement écarteur
Sólo Retractor
14-2375-01
15 cm/6"

Caspar
14-2375-00
14-2376-45
14-2377-65

Retractor Complete With 1 Blade Each
Retractor komplett mit 1 Klinge Jeder
Écarteur complet avec Chaque lame 1
Retractor completo con Cada una hoja



Retractor Only
Retractor Nur
Seulement écarteur
Sólo Retractor

14-2378-01
15 cm/6"

Caspar
14-2378-00
14-2379-45
14-2379-65

Retractor adjustable, con 1 blade each
Retractor einstellbar, con 1 Klinge jedes
Écarteur réglable, con 1 lame à chaque
Separador ajustable, con una hoja cada

Neuro and Laminectomy Instruments

Lamina Spreaders
Lamina Spreader

Epandage lamina
Separadores de Lamina



14



Cloward
14-2380-00
15 cm/6"

Complete with 5 blades
Komplett mit 5 Klängen
Livré avec 5 lames
Completo con 5 cuchillas

14-2380-01
Retractor Only
Retractor Nur
Seulement écarteur
Sólo Retractor



14-2381-01
Retractor Only
Retractor Nur
Seulement écarteur
Sólo Retractor

Cloward
14-2381-00
25 cm/10"

Complete with 5 blades
Komplett mit 5 Klängen
Livré avec 5 lames
Completo con 5 cuchillas



14-2380-40
15x40 mm



14-2380-45
15x45 mm



14-2380-50
15x50 mm



14-2380-55
15x55 mm



14-2380-60
15x60 mm



14-2381-40
15x40 mm



14-2381-45
15x45 mm



14-2381-50
15x50 mm



14-2381-55
15x55 mm



14-2381-60
15x60 mm

Neuro and Laminectomy Instruments

Lamina Spreaders
Lamina Spreader

Epannage lamina
Separadores de Lamina



Inge
14-2382-27
27 cm/10¾"

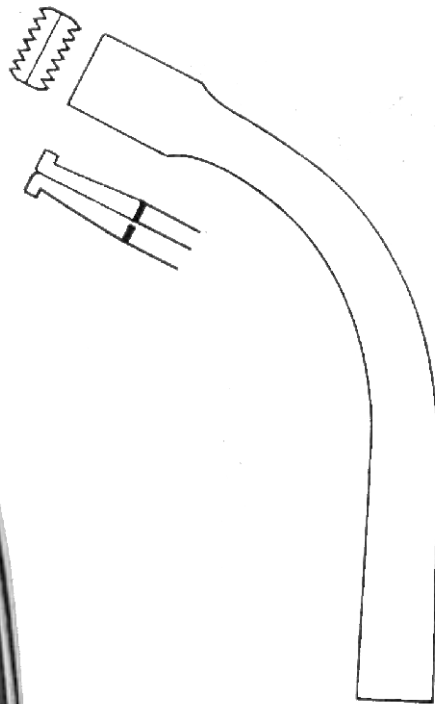

Inge
14-2383-16
16 cm/6¼"

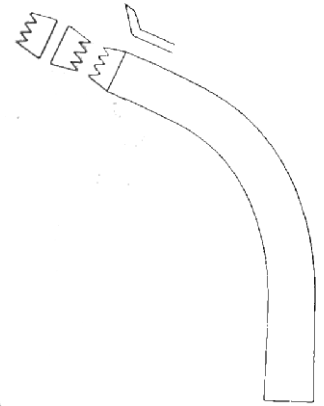

Cloward
14-2384-16
16 cm/6¼"



Neuro and Laminectomy Instruments

Lamina Spreaders
Lamina Spreader

Epandage lamina
Separadores de Lamina



14



Frame
14-2385-01

Hey
14-2385-00
14-2386-00
23 cm/9"

Muscle blades
Muscle Klingen
lames musculaires
hojas musculares

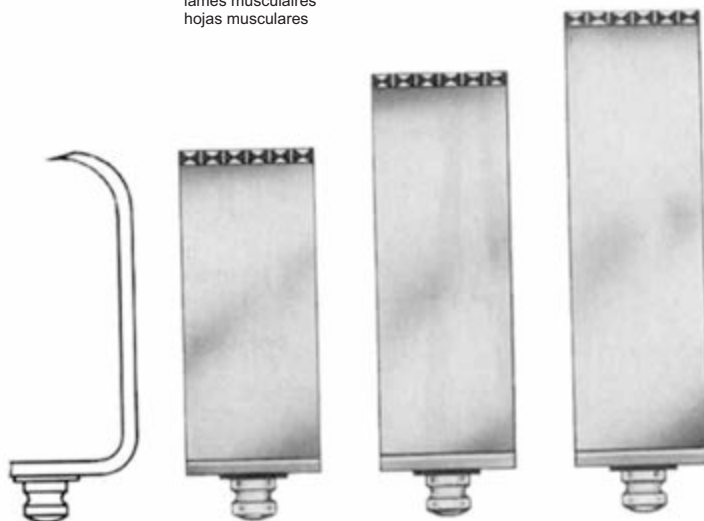

14-2385-50
20x50 mm

14-2385-60
20x60 mm

14-2385-70
20x70 mm

Vertebra-pins
Wirbel-pins
vertèbres broches
vértebras-pins

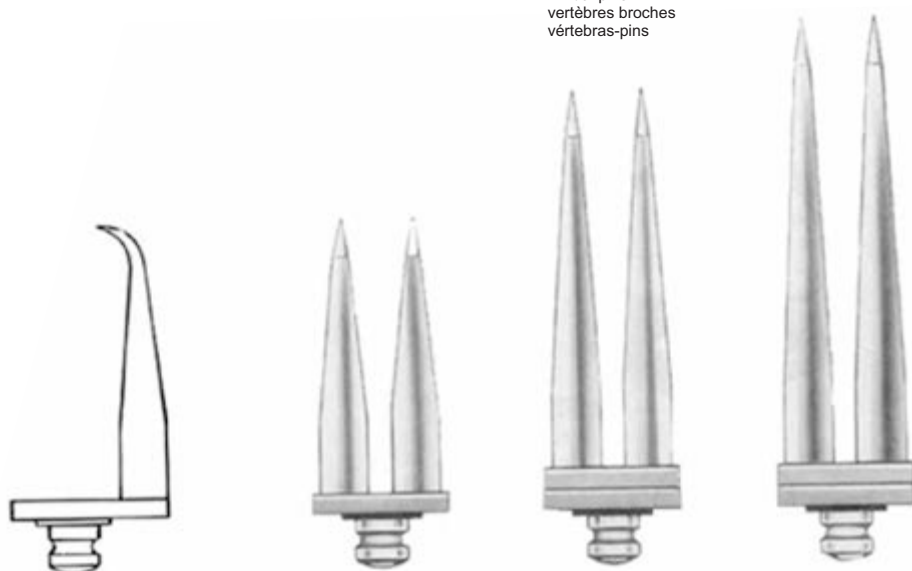

14-2386-50
50 mm

14-2386-60
60 mm

14-2386-70
70 mm

Neuro and Laminectomy Instruments

Lamina Spreaders
Lamina Spreader

Ebandage lamina
Separadores de Lamina

Left-type
Left-Typ
Gauche type
De tipo izquierdo



17 cm/6³/₄"

Right-type
Rechts-Typ
Droit de type
Haga tipo

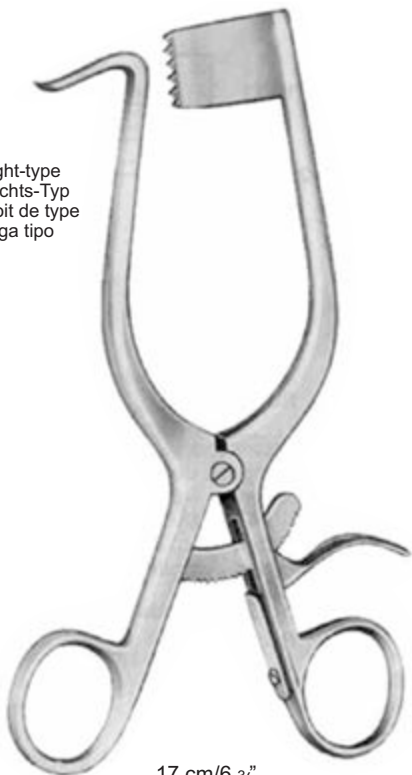

17 cm/6 ³/₄"

Left-type
Left-Typ
Gauche type
De tipo izquierdo

Right-type
Rechts-Typ
Droit de type
Haga tipo

50x10 mm

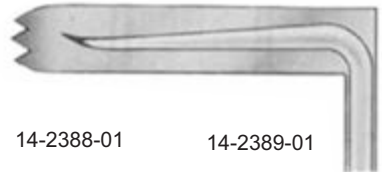

14-2388-01

14-2389-01

60x10 mm

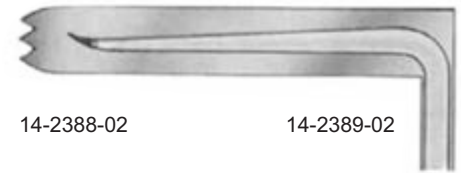

14-2388-02

14-2389-02

70x10 mm



14-2388-03

14-2389-03

50x20 mm

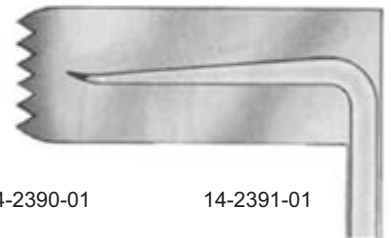

14-2390-01

14-2391-01

60x20 mm

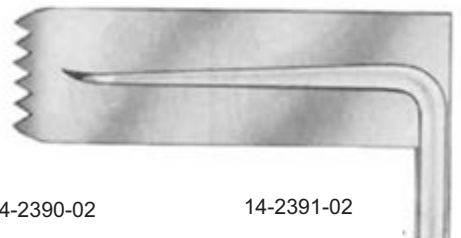

14-2390-02

14-2391-02

70x20 mm

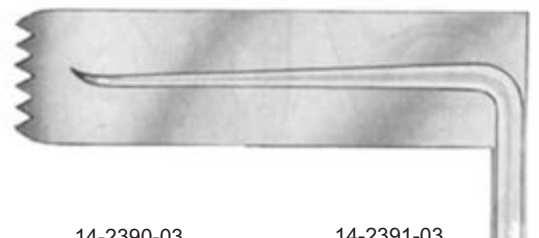

14-2390-03

14-2391-03

Neuro and Laminectomy Instruments

Muscle Retractors
Muscle Retraktoren

Rétracteurs musculaires
Los retractoros del músculo



14

Henly

Toothed

Complete Consisting of
bestehend aus vervollständigen
composée d' compléter
Compuesto por completar

Standard

14-2392-00 14.5 cm/5¾"
14-2393-00 17 cm/6¾"

14-2392-01 14-2393-01
16 x 19 mm 14-2392-21 14-2393-21
16 x 25 mm 14-2392-22 14-2393-22
16 x 32 mm 14-2392-23 14-2393-23

Frame
Centre Blades
Zentrum Blades
Lames Centre
Hojas Centro

16 x 19 mm
16 x 25 mm
16 x 32 mm

Deep Type

Complete Consisting of
bestehend aus vervollständigen
composée d' compléter
Compuesto por completar

14-2394-00 14.5 cm/5¾"
14-2395-00 17 cm/6¾"

14-2394-01 14-2395-01
14-2394-21 14-2395-21
14-2394-22 14-2395-22
14-2394-23 14-2395-23

Centre Blades
Zentrum Blades
Lames Centre
Hojas Centro

Neuro and Laminectomy Instruments

Brain Retractors
Gehirn-Reraktoren

Rétracteurs cerveau
Los retractoros del cerebro

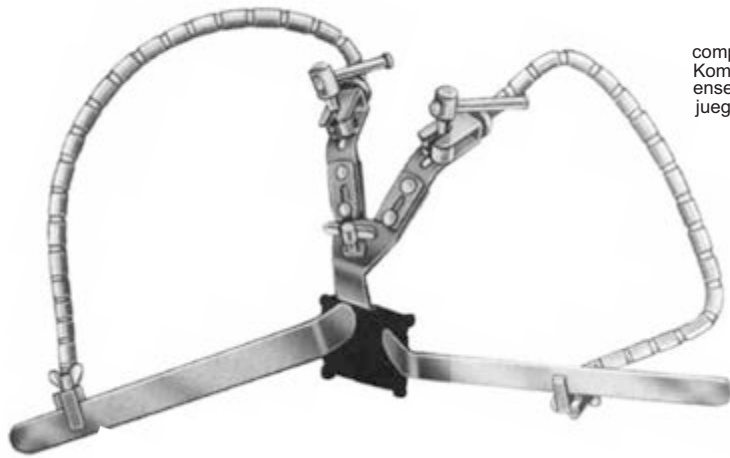

complete set
Komplett-Set
ensemble complet
juego completo

Yasargil
14-2396-00
2 14-2396-01
1 14-2396-02
2 14-2396-03

Self-retaining brain retractor, with 2 flexible arms, complete, consisting of:
Selbsthaltung Gehirn Retraktor mit 2 flexiblen Armen, komplett, bestehend aus:
Écarteur autostatique cerveau, avec 2 bras flexibles, complets, consistant en:
Auto-retención cerebro retractor, con 2 brazos flexibles y completos, que consiste en:



Yasargil complete set
14-2397-00 Komplett-Set
1 14-2397-01 ensemble complet
1 14-2397-02 juego completo
1 14-2397-10

Self-retaining brain retractor, with 1 flexible arm, complete, consisting of:
Selbsthaltung Gehirn Retraktor mit 1 flexiblen Arm, komplett, bestehend aus:
Écarteur autostatique cerveau, avec 1 bras flexible, complet, consistant en:
Auto-retención cerebro retractor, con un brazo flexible, completa, que consiste en:



14-2398-10
wire cable only
Draht-Kabel nur
câble métallique ne
alambre cable sólo



14-2398-01
Fixation base, for skull mounting, holding 1 flexible arm
Fixation Base, Schädel-Montage, Halten 1 flexiblen Arm
Base de fixation, pour le montage du crâne, détenant 1 bras flexible
Base de fijación, para el montaje del cráneo, la celebración de un brazo flexible



14-2398-02
Fixation base, for skull mounting, holding 2 flexible arms
Fixation Base, Schädel-Montage, Halten 2 flexiblen Armen
Base de fixation, pour le montage du crâne, n'excédant pas 2 bras flexibles
Base de fijación, para el montaje del cráneo, la celebración de dos brazos flexibles

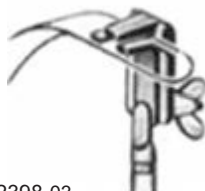

14-2398-03
Support only, flat brain spatulas, Unterstützen nur, flache Gehirn Spatel, Prennent en charge que le cerveau, spatules plates, Apoyo espátulas, el cerebro sólo planos,



14-2398-04
Support only, for brain spatulas with round shaft up to 5,5 mm diam. Fixing for flexible
Unterstützt nur für Gehirn-Spatel mit runden Wellenenden bis 5,5 mm Durchmesser. Befestigung für flexible
Prennent uniquement en charge, pour spatules cerveau avec tige ronde jusqu'à 5,5 mm de diamètre. Fixation pour flexibles
Único apoyo, para espátulas cerebrales con eje redondo hasta un diámetro de 5,5 mm. La fijación de criterios flexibles

Neuro and Laminectomy Instruments

Intervertebral Disc Rongeurs
Inter Bandscheibe Rongeure



Rongeurs disques intervertébraux
Los roedores del disco intervertebral



14



Ferris-Smith-Kerrison

	Width of Bite Breite der Biss Largeur de Bite Ancho de Bite	Length of Shaft Länge der Welle Longueur de l'arbre Longitud del eje		
	15 cm/6"	20 cm/8"	18 cm/7"	
	0.6 mm		14-2401-00	
	1 mm		14-2401-01	
	2 mm		14-2401-02	
	3 mm	14-2399-03	14-2400-03	14-2401-03
	4 mm		14-2400-05	14-2401-04
5 mm	14-2399-05		14-2401-05	
			14-2404-00	
	0.6 mm		14-2404-01	
	1 mm		14-2404-02	
	2 mm		14-2404-03	
	3 mm	14-2402-03	14-2403-03	14-2404-03
	4 mm		14-2403-05	14-2404-04
5 mm	14-2402-05		14-2404-05	
			14-2407-00	
	0.6 mm		14-2407-01	
	1 mm		14-2407-02	
	2 mm		14-2407-03	
	3 mm	14-2405-03	14-2406-03	14-2407-03
	4 mm		14-2406-05	14-2407-04
5 mm	14-2405-05		14-2407-05	



Neuro and Laminectomy Instruments

Intervertebral Disc Rongeurs
Inter Bandscheibe Rongeur

Rongeurs disques intervertébraux
Los roedores del disco intervertebral



Ferris-Smith-Kerrison

		Width of Bite Breite der Biss Largeur de Bite Ancho de Bite	15 cm/6"	20 cm/8"	18 cm/7"
Cutting Upward Schneiden nach oben couper vers le haut Cortar hacia arriba...		3 mm	14-2408-03	14-2409-03	14-2410-03
		5 mm	14-2408-05	14-2409-05	14-2410-05
Cutting Upward 40° Schneiden Upward 40° Couper vers le haut 40° Cortar hacia arriba 40°		3 mm	14-2411-03	14-2412-03	
		5 mm	14-2411-05	14-2412-05	
Cutting Downwards Schneiden Downwards En contrebas de coupe Hacia abajo de Corte		3 mm	14-2413-03	14-2414-03	14-2415-03
		5 mm	14-2413-05	14-2414-05	14-2415-05

Neuro and Laminectomy Instruments

Intervertebral Disc Rongeurs
Inter Bandscheibe Rongeure

Rongeurs disques intervertébraux
Los roedores del disco intervertebral



14



Schaftlänge Length of shaft Largo de vastago Schaftlänge Länge der Welle Largo de vastago Longueur de l'arbre Schaftlänge Largo vastago de Schaftlänge Longitud del eje Largo de vastago	150 mm 6"	190 mm 8"	150 mm 6"	190 mm 8"
BiBbreite Width of Bite Ancho de la boca BiBbreite Breite der Biss Ancho de la boca Largeur BiBbreite de Bite Ancho de boca la Ancho BiBbreite de Bite Ancho de la boca	3 mm	3 mm	5 mm	5mm
Art-Nr. Cat. Ref.	14-2416-03	14-2417-03	14-2418-06	14-2419-06

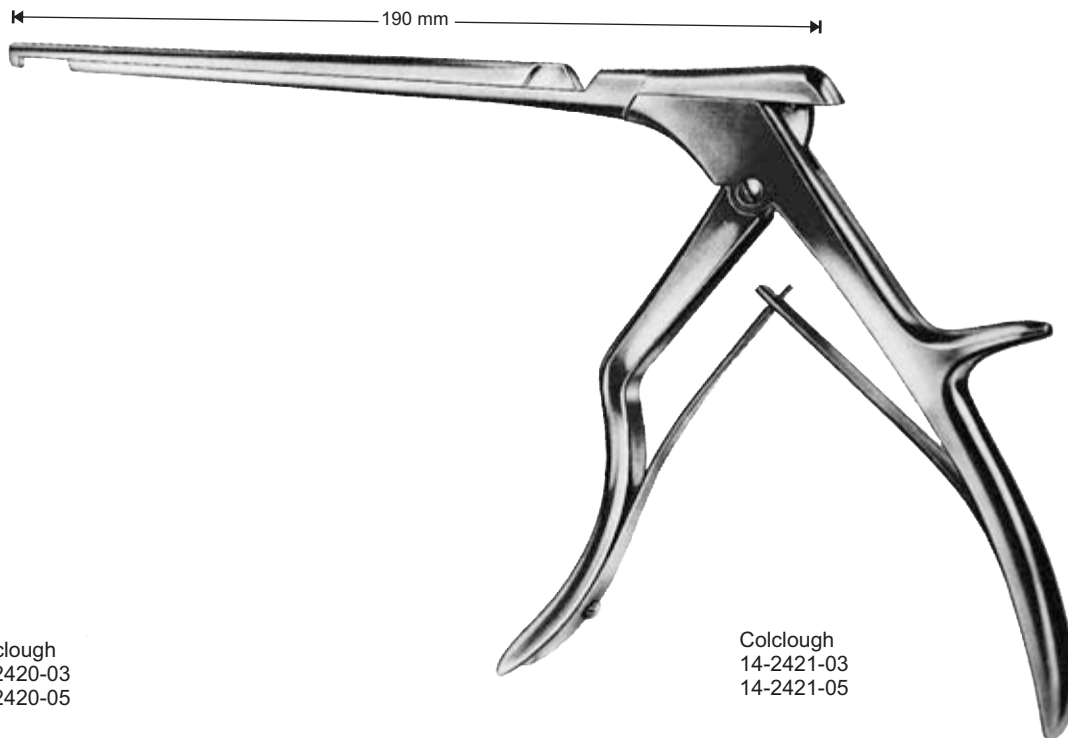

Colclough
14-2420-03
14-2420-05

Colclough
14-2421-03
14-2421-05

Neuro and Laminectomy Instruments

Laminectomy Rongeurs
Laminektomiestanzen

Rongeurs laminectomie
Rongeurs laminectomia

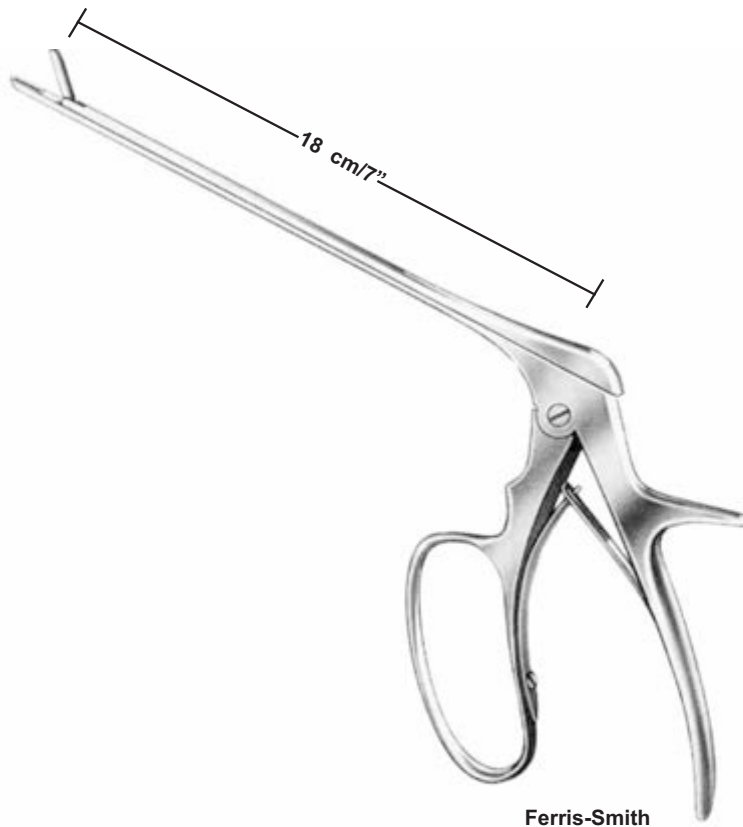

Widh Of Jaw
Widh Of Jaw
Veulent consacrer la mâchoire
Widh de la mandíbula

2 x 10 mm	14-2422-02	14-2423-02	14-2424-02
3 x 10 mm	14-2422-03	14-2423-03	14-2424-03
4 x 10 mm	14-2422-04	14-2423-04	14-2424-04

Neuro and Laminectomy Instruments

Laminectomy Rongeurs
Laminektomiestanzen

Rongeurs laminectomie
Rongeurs laminectomía



14



Serrated and Fenestrated Jaws
Serrated und Fenestrated Jaws...
Dentelé et Jaws fenêtrée
Dentada y mordazas fenestradas

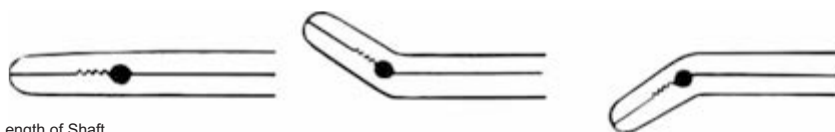

Width Of Jaw
Width Of Jaw
Veulent consacrer la mâchoire
Widh de la mandíbula

Length of Shaft
Länge der Welle
Longueur de l'arbre
Longitud del eje

Width Of Jaw	Length of Shaft			
mm	14 cm/5 1/2"	14-2425-01	14-2425-02	14-2425-03
	16 cm/6 1/4"	14-2426-01	14-2426-02	14-2426-03
2 x 12	14 cm/5 1/2"	14-2427-01	14-2427-02	14-2427-03
	16 cm/6 1/4"	14-2428-01	14-2428-02	14-2428-03
3 x 12	14 cm/5 1/2"	14-2429-01	14-2429-02	14-2429-03
	16 cm/6 1/4"	14-2430-01	14-2430-02	14-2430-03
4 x 14	14 cm/5 1/2"	14-2431-01	14-2431-02	14-2431-03
	16 cm/6 1/4"	14-2432-01	14-2432-02	14-2432-03
5 x 14	14 cm/5 1/2"	14-2433-01	14-2433-02	14-2433-03
	16 cm/6 1/4"	14-2434-01	14-2434-02	14-2434-03
6 x 16	14 cm/5 1/2"			
	16 cm/6 1/4"			

Neuro and Laminectomy Instruments

Laminectomy Rongeurs
Laminektomiestanzen

Rongeurs laminectomie
Rongeurs laminectomía

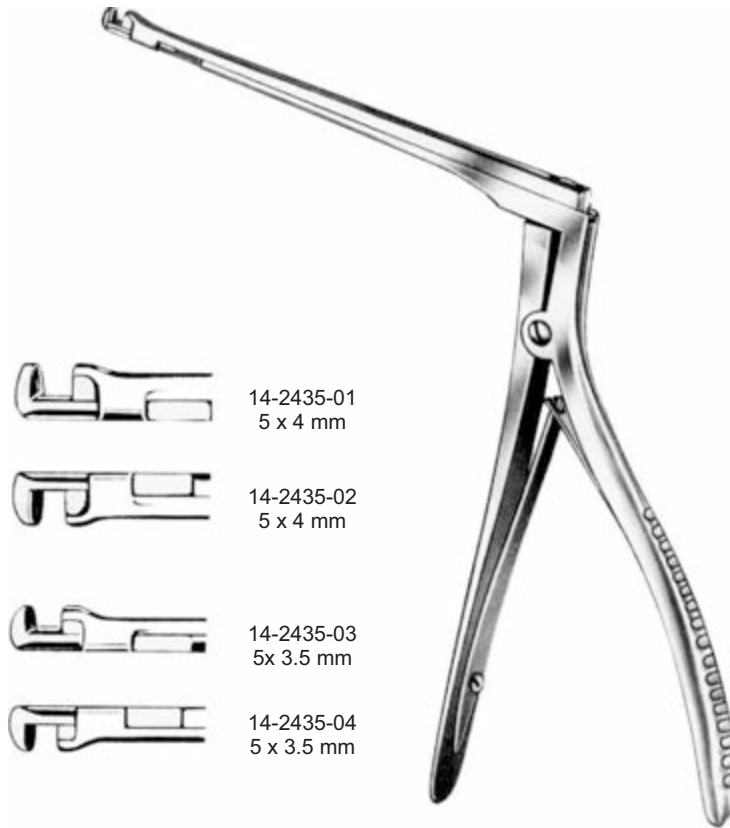

14-2435-01
5 x 4 mm



14-2435-02
5 x 4 mm



14-2435-03
5x 3.5 mm



14-2435-04
5 x 3.5 mm

Hajek
(Hajek-Kofler)
14 cm/5½"

360° Turnable
360° Drehbare
360° Turnable
360° Turnable

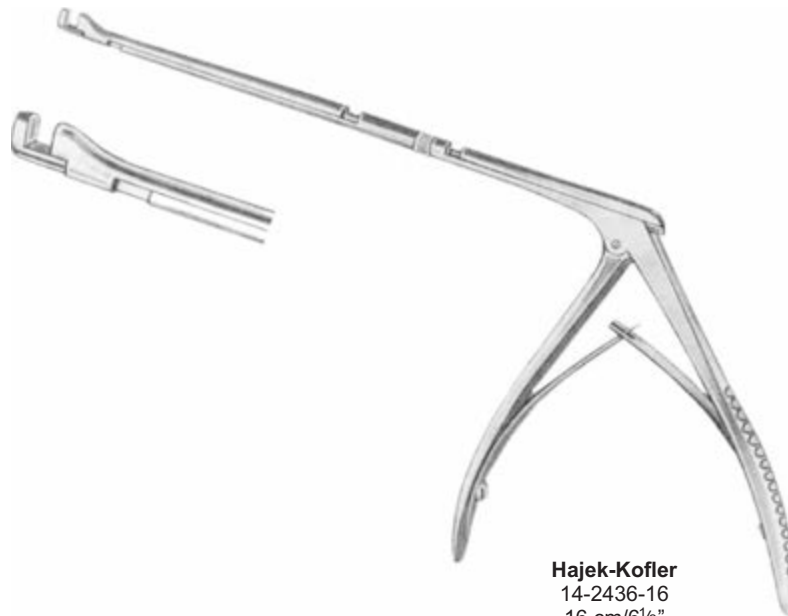

Hajek-Kofler
14-2436-16
16 cm/6½"

Neuro and Laminectomy Instruments

Laminectomy Rongeurs
Laminektomiestanzen

Rongeurs laminectomie
Rongeurs laminectomia



14

Ø 6.5 mm



Oldberg
14-2437-65
18 cm/7"

Ø 3.5 mm

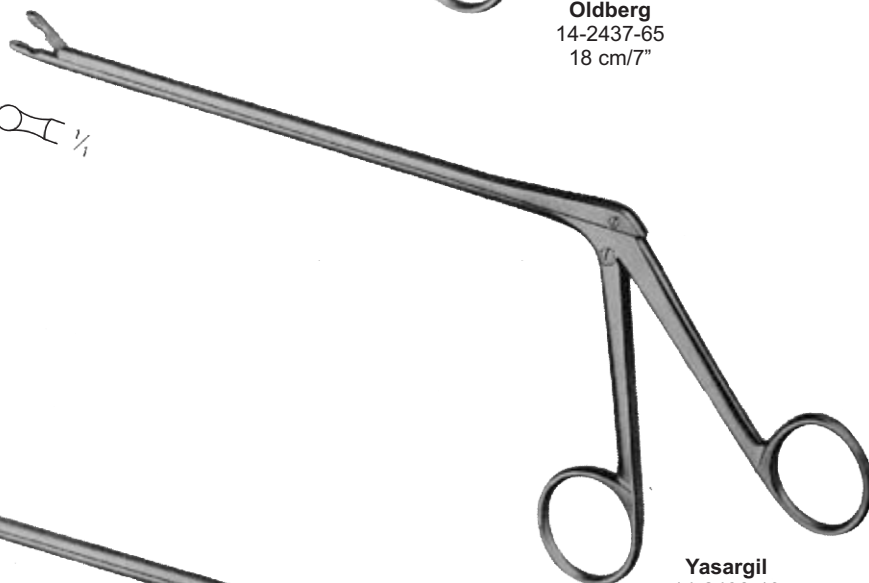

Yasargil
14-2438-19
19.5 cm/7¾"

Ø 9 mm

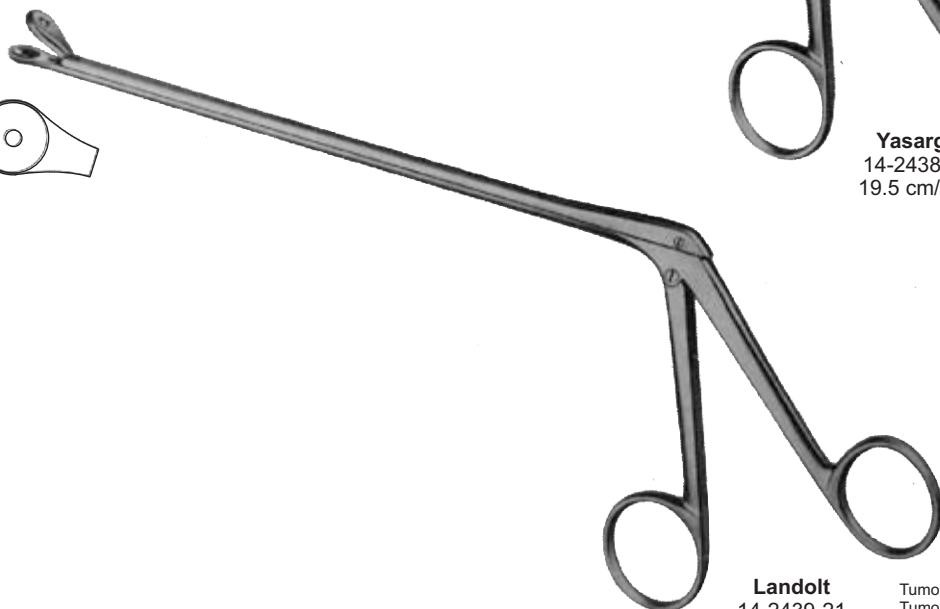

Landolt
14-2439-21
21 cm/8¼"

Tumor Grasping Forceps Blunt
Tumor Faßzange Blunt
Tumeur pince à préhension Blunt
Tumor Entender Pinzas Blunt

Tracheotomy Instruments

Trachea Dilators and Retractors
Trachea Dilatatoren und Retraktoren

Dilatateurs trachée et rétracteurs
Tráquea dilatadores y retractoros

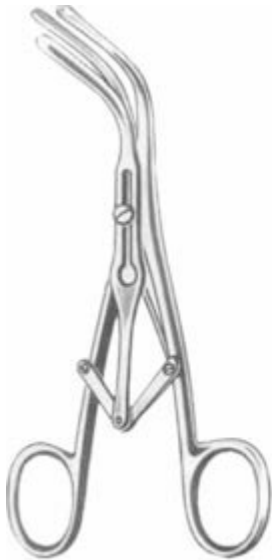

Laborde
15-2440-15 15 cm/6"



Trousseau
15-2441-14
14 cm/5½"



Trousseau-Baby
15-2442-13
13 cm/5"

Hooks



Bose
15-2443-07
7 cm/2¾"



15-2444-01
Left links
links
Izquierda

Sharp
scharf
net
agudo



15-2444-02
Right
rechts
droit
derecho

Bose
16 cm/6¼"



Schoenborn
15-2445-21
21 cm/8¼"

Thyroid Gland Retractor

Trachea Trocars
Trachea Trokare
trachée trocarts
tráquea trócares



Uckerman
15-2446-08 8 mm Ø
15-2446-10 10 mm Ø
13 cm/5"

Tracheotomy Instruments

Trachea Tubes
Trachealkanülen

Trachée Tubes
tráquea Tubos



15

Fig	0	1	2	3	4	5	6	7	8	9
Ø mm	04	05	06	07	08	09	10	11	12	13
Charr./Fr.	12	15	18	21	24	27	30	33	36	39
	45	50	55	60	65	70	75	80	85	90

Length of Outer Tube
Länge der äußeren Röhre
Longueur du tube extérieur
Longitud del tubo exterior



Luer

Fig.	mm Ø	
0	4	15-2447-04
1	5	15-2447-05
2	6	15-2447-06
3	7	15-2447-07
4	8	15-2447-08
5	9	15-2447-09
6	10	15-2447-10
7	11	15-2447-11
8	12	15-2447-12
9	13	15-2447-13

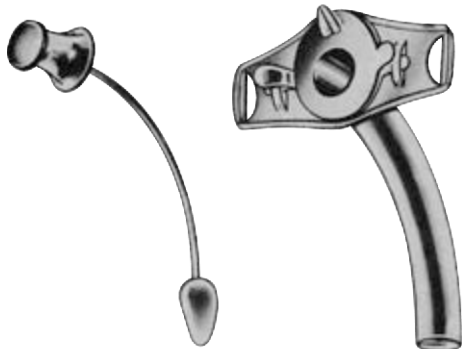

Chavalier Jackson

Fig.	mm Ø	
0	4	15-2448-04
1	5	15-2448-05
2	6	15-2448-06
3	7	15-2448-07
4	8	15-2448-08
5	9	15-2448-09
6	10	15-2448-10
7	11	15-2448-11
8	12	15-2448-12
9	13	15-2448-13

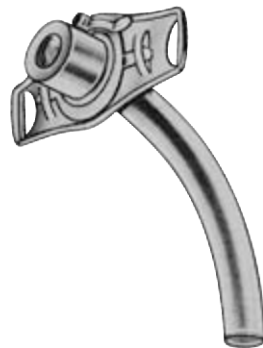

Fueller

Fig.	F.G.	
1	18	15-2449-18
2	20	15-2449-20
3	22	15-2449-22
4	24	15-2449-24
5	26	15-2449-26
6	28	15-2449-28
7	30	15-2449-30
8	32	15-2449-32

Goitre Instruments

Probes, Goitre, Grasping and Muscle Clamps
 Probes, Kropf, Greifen und Muscle Schellen

Sondes, le goitre, préhension et pinces musculaires
 Las sondas, el bocio, agarrar y abrazaderas musculares



16-2450-15
 16-2450-16



Kocher
 15 cm/6"
 16 cm/6¼"



16-2451-15
 16-2451-16



16-2452-18



Kocher
 18cm/7"



16-2453-18



Mastin
 17 cm/6¾"

Muscle Forceps
 16-2454-17



Lahey
 16-2455-15 15 cm/6"
 16-2455-20 20 cm/8"

Goitre Grasping Forceps
 Kropf Fasszange
 Pince à préhension goitre
 Bocio Agarre Pinzas

Dermatology Instruments

Comedone Extractors and Skin Currettes
Komedos Extraktoren und Haut-Küretten

Extracteurs comédon et Currettes de la peau
Extractores y comedones Curretas la piel



17



Unna
17-2456-14
14 cm/5½"



Unna
17-2457-14
14 cm/5½"



Schamberg
17-2458-10
10 cm/4"



Sealfeld
17-2459-10
10 cm/4"



Saalfeld
17-2460-14
14 cm/5½"



Hebra
17-2461-18
18 cm/7"



Piffard
14.5cm/5¾"

Skin Currettes
Haut Currettes
Currettes peau
Curretas piel



Fig. 1 17-2462-01



Fig. 2 17-2462-02



Fig. 3 17-2462-03

Dermatology Instruments

Lupus Currettes, Scraper, Moncrops Knife and
Cutaneous Hooks, Trephines
Lupus Küretten, Schaber, Messer und Moncrops
Kutane Haken, Trepane

Currettes lupus, raclettes, des couteaux et Moncrops
Crochets cutanées, trépan
Curetas Lupus, un raspador, cuchillos y Moncrops
Ganchos cutáneas, trépanos



Besnier
13.5 cm/5¼"

- 
- 17-2463-02 2 mm
 - 17-2463-03 3 mm
 - 17-2463-04 4 mm
 - 17-2463-05 5 mm
 - 17-2463-06 6 mm
 - 17-2463-07 7 mm

- 
- 17-2464-02 2 mm
 - 17-2464-03 3 mm
 - 17-2464-04 4 mm
 - 17-2464-05 5 mm
 - 17-2464-06 6 mm
 - 17-2464-07 7 mm

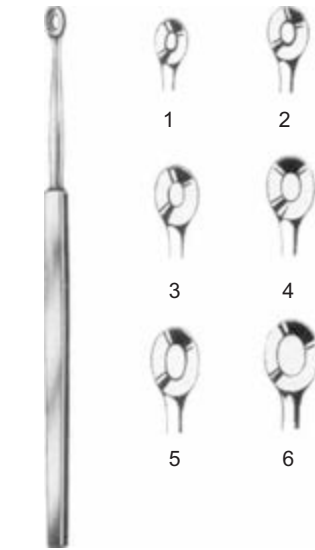

Wolff
14 cm/5½"

- Fig.
- 1 17-2465-01
 - 2 17-2465-02
 - 3 17-2465-03
 - 4 17-2465-04
 - 5 17-2465-05
 - 6 17-2465-06

Lupus Currettes

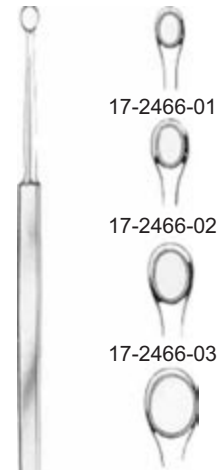

Fox
14 cm/5½"

Lupus Scraper
grattoir lupus
lupus raspador



Brock
17-2467-13
13 cm/5"



Vidal
17-2468-14
14 cm/5½"

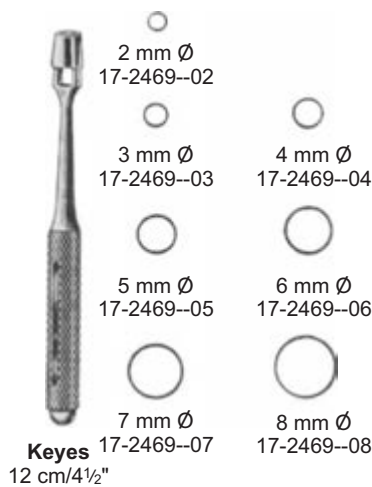



Keyes
12 cm/4½"



Gillies
Fig. 1 17-2470-01
Fig. 2 17-2470-02
18 cm/7"

Cutaneous Hook
kutane Haken
Crochet cutanée
Hook cutánea

- 
- Fig. 1
- 
- Fig. 2



Kilner
17-2471-15
15 cm/6"

Stomach, Intestine and Rectum Instruments

Tissue Seizing Forceps and Intestinal
Atrauma Tissue Forceps
Tissue ergriff Pinzetten und Darm Atrauma Pinzette

Saisir les tissus intestinaux et Pince Forceps tissus atraumatique
Aprovechando los tejidos Pinzas Pinzas intestinales y
tisulares Atrauma



18

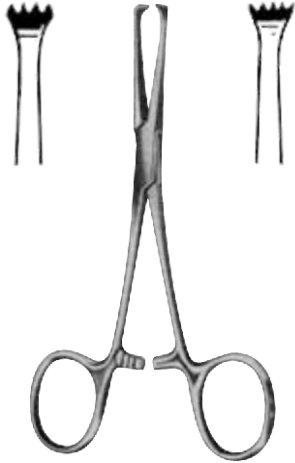

Baby-Allis

18-2472-12 12 cm/4¾"
18-2472-14 14 cm/5½"



Allis

cm	in	4 : 5	5 : 6
15	6"	18-2473-15	18-2474-15
19	7½"		18-2475-19
25	10"		18-2475-25

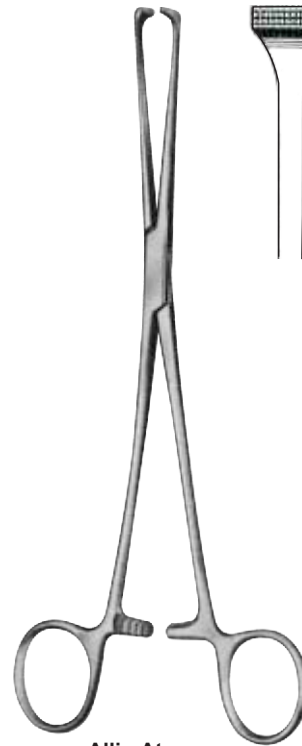

Allis-Atrauma

18-2475-16	16 cm/6¼"
18-2475-20	20 cm/8"
18-2475-25	25 cm/10"
18-2475-30	30 cm/12"

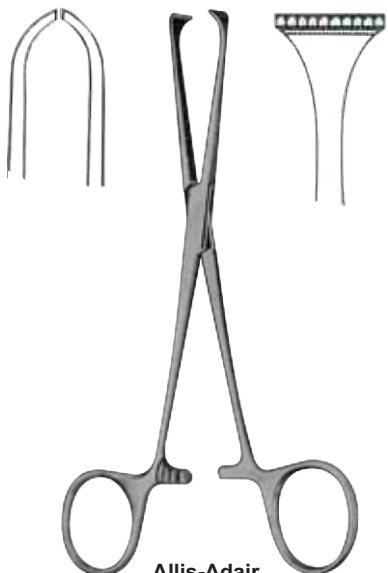

Allis-Adair
18-2476-15
15 cm/6"

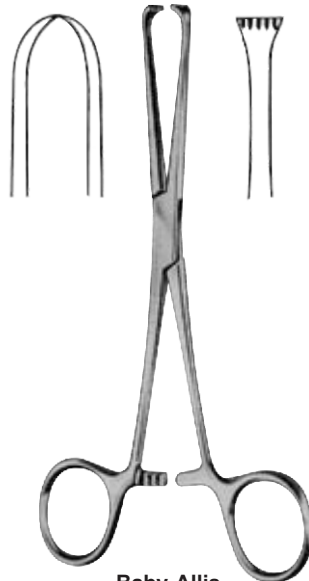

Baby-Allis
18-2477-15
15 cm/6"



Lockwood-Allis
18-2478-16 16 cm/6¼"
18-2477-20 20 cm/8"

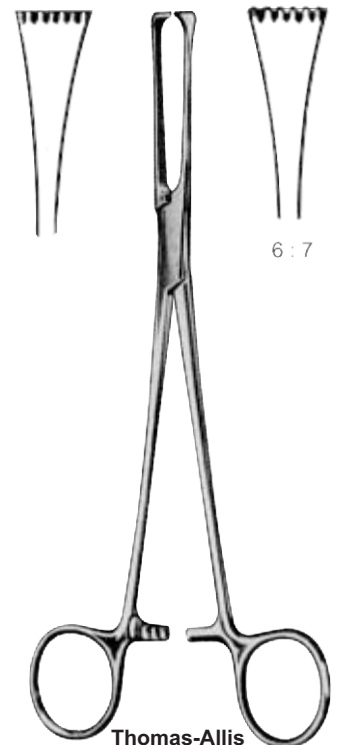

Thomas-Allis
18-2479-20
20 cm/8"

Stomach, Intestine and Rectum Instruments

Intestinal Tissue Forceps, Atrauma,
and Tungsten Carbide Inserts

Intestinale Pinzette, Atrauma, und Hartmetalleinlagen

Pince tissu intestinal, atraumatique, et de carbure de tungstène

Pinzas intestinales y tisulares Atrauma, y los rellenos de carburo de tungsteno

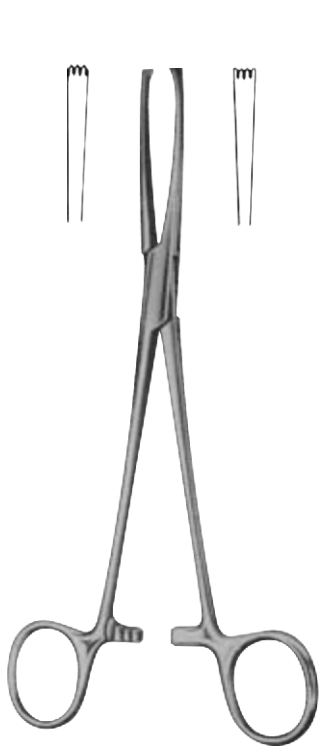

Judd-Allis
18-2480-15 15 cm/6"
18-2480-19 19 cm/7 1/2"



Littlewood
18-2481-18
18.5 cm/7 1/4"

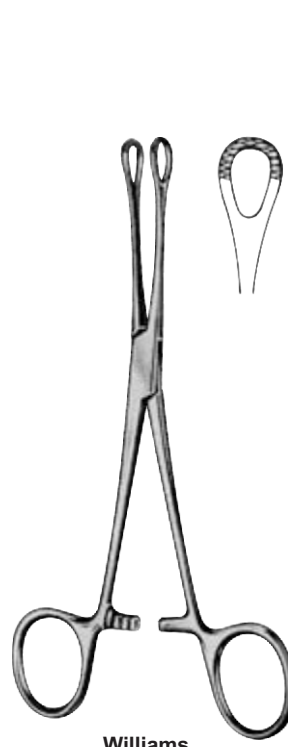

Williams
18-2482-16
16 cm/6 1/4"



Lockwood
18-2483-20
20 cm/8"

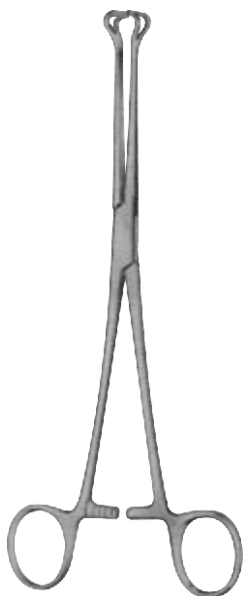

cm/in **Babcock-Atrauma**
16 cm/6 1/4" 18-2484-16
18 cm/7" 18-2484-18
20 cm/8" 18-2484-20
24 cm/9 1/2" 18-2484-24



Babcock(Standard)
18-2485-16
18-2485-18
18-2485-20
18-2485-24



Baby-Babcock
18-2486-16



Babcock
18-2487-16
18-2487-20

Stomach, Intestine and Rectum Instruments

Intestinal Tissue and Organ Grasping Forceps
Darmgewebe und Organ Grasing Zange

Tissu intestinal et Pince Grasping organes
Pinzas de tejido intestinal y órganos Grasing



18

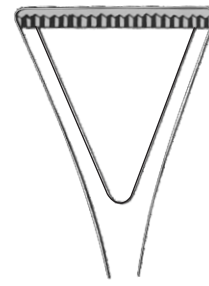

	Duval		
	cm	in	
18-2489-18	18	7"	
18-2489-20	20	8"	18-2490-20
18-2489-23	23	9"	18-2490-23



Duval
18-2491-20
20 cm/8"

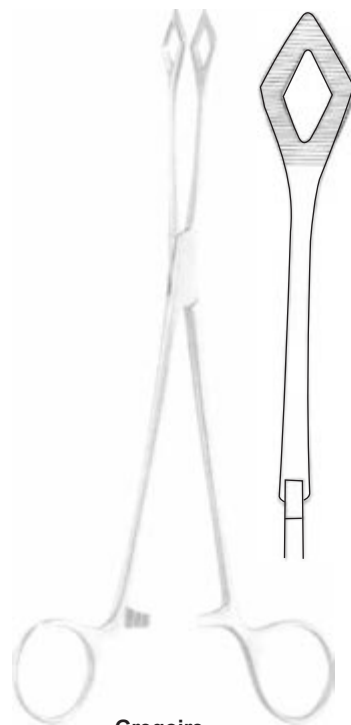

Gregoire
18-2492-16 16 cm/6 1/4"
18-2492-18 18 cm/7"
18-2492-20 20 cm/8"
18-2492-22 22 cm/8 3/4"



Coeur



18-2493-25
24 cm/10"



18-2493-26
26 cm/10 1/4"

Stomach, Intestine and Rectum Instruments

Intestinal Clamps Forceps
Darmklammern Zange

Intestinaux Forceps Pincés

Pinzas Pinzas intestinales

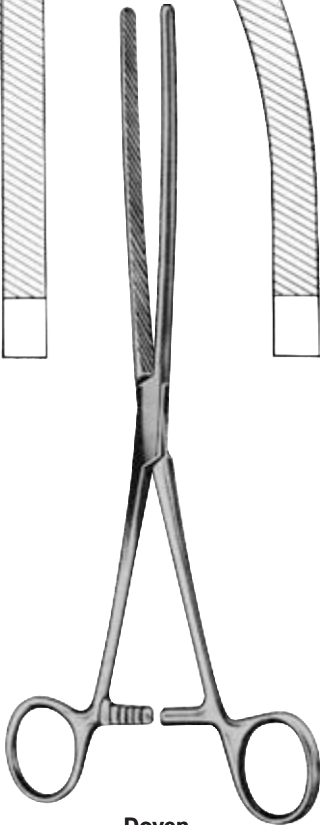
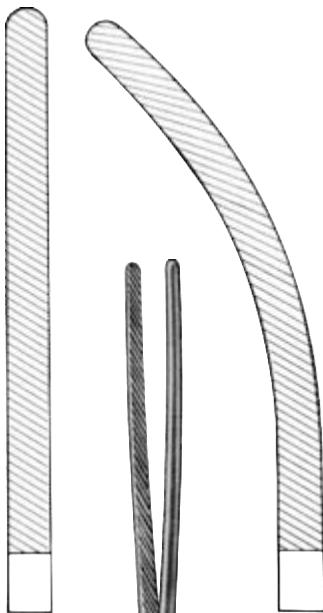

Doyen

18-2496-21 21 cm/8 1/4"
18-2496-23 23 cm/9"

Straight
gerade
droit
recto

18-2497-21 21 cm/8 1/4"
18-2497-23 23 cm/9"

Curved
Gebogene
courbés
Curvo

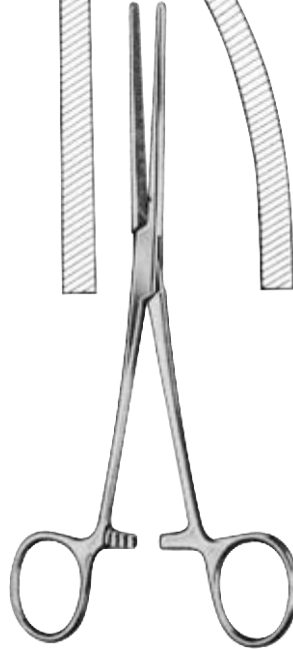
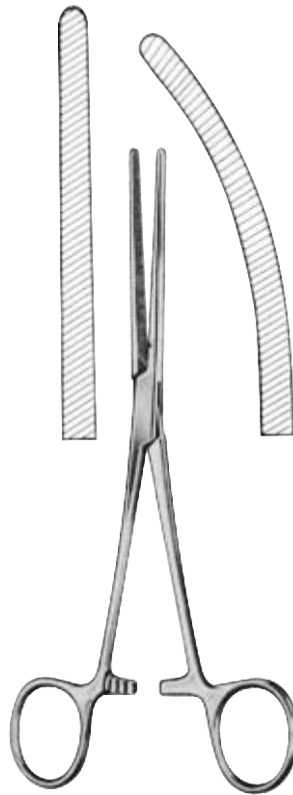

Baby-Doyen

18-2494-18
18 cm/7"

Straight
gerade
droit
recto

18-2495-18
18 cm/7"

Curved
Gebogene
courbés
Curvo

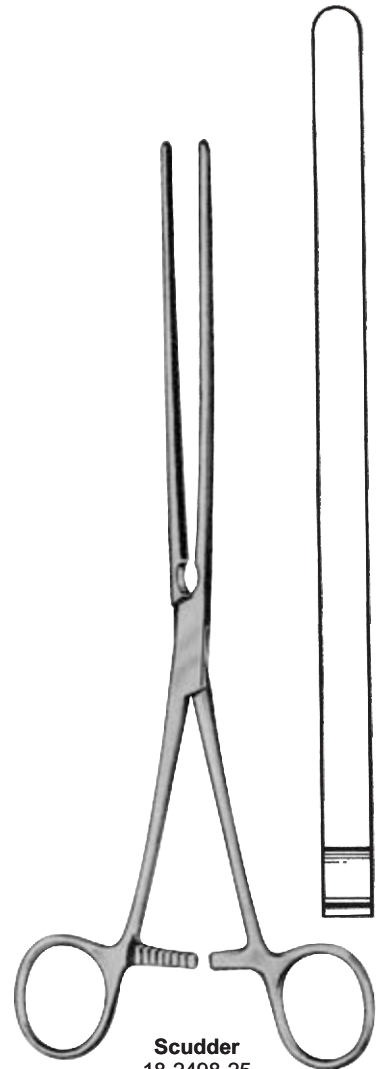

Scudder
18-2498-25
25 cm/10"

Stomach, Intestine and Rectum Instruments

Atrauma Intestinal Clamps Forceps
 Atrauma Darmklammern Zange

Atraumatique intestinaux Forceps Pinces
 Atrauma Abrazaderas Pinzas intestinales



18

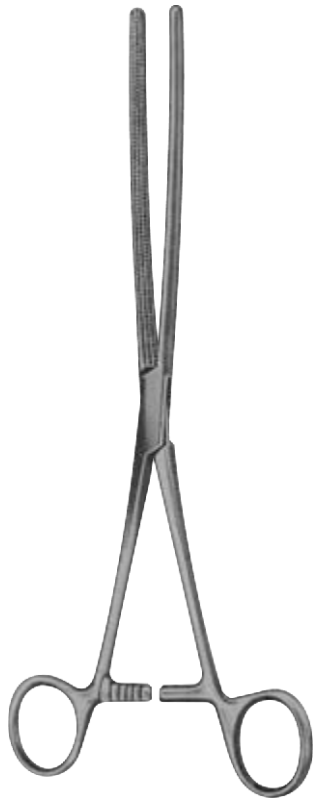

Doyen-Atrauma

Straight
 gerade
 droit
 recto



18-2498-13
 13 cm/5"



18-2498-16
 16 cm/6 1/4"



18-2498-18
 18 cm/7"



18-2498-21
 21 cm/8 1/4"



18-2498-23
 23 cm/9"

Curved
 Gebogene
 courbée
 Curvo



18-2499-13
 13 cm/5"



18-2499-16
 16 cm/6 1/4"

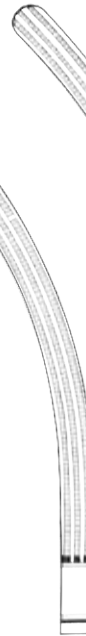

18-2499-18
 18 cm/7"

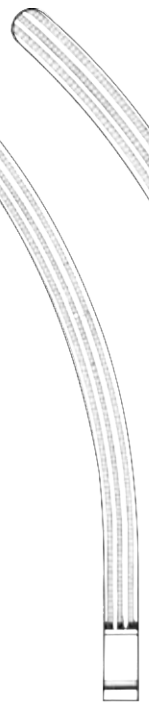

18-2499-21
 21 cm/8 1/4"

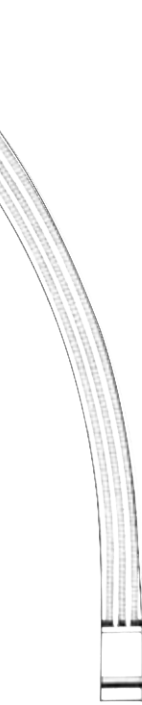

18-2499-23
 23 cm/9"

Stomach, Intestine and Rectum Instruments

Intestinal Clamps Forceps
Darmklammern Zange

Intestinaux Forceps Pincés
Pinzas Pinzas intestinales



Mayo-Robson
Mayo-Robson Atrauma



18-2500-21
21 cm/8 1/4"

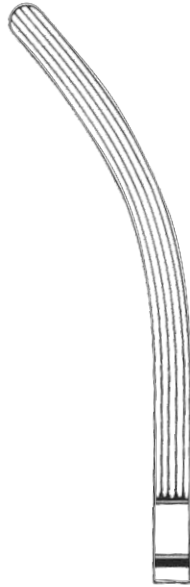

18-2501-21
21 cm/8 1/4"



18-2502-23
23 cm/9"



18-2503-23
23 cm/9"



18-2504-25
25 cm/10"

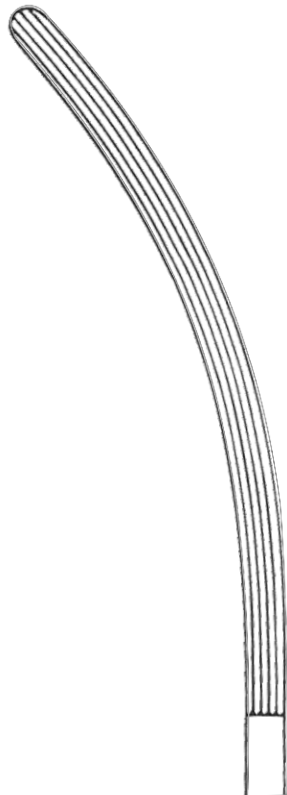

18-2505-25
25 cm/10"



18-2506-25
25 cm/10"

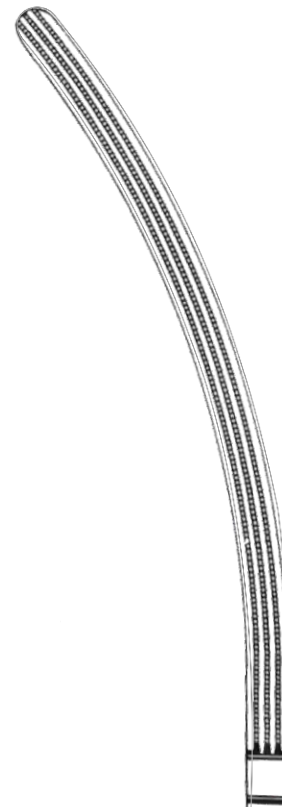

18-2507-25
25 cm/10"

Stomach, Intestine and Rectum Instruments

Intestinal Clamps Forceps
Darmklammern Zange

Intestinaux Forceps Pince
Pinzas Pinzas intestinales



18

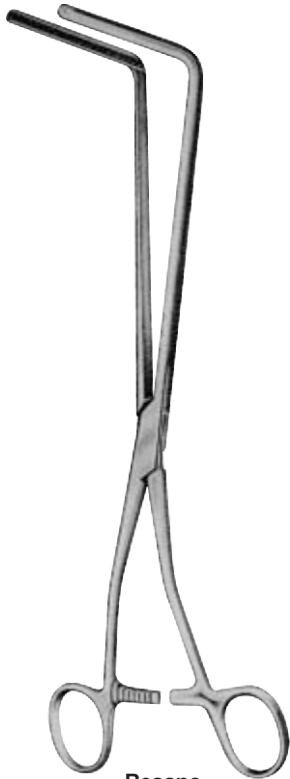

Resano
18-2508-30
30 cm/12"



Hayes



18-2509-26
26 cm/10¼"

18-2509-28
28 cm/11"

Stomach, Intestine and Rectum Instruments

Intestinal Clamps Forceps
Darmklammern Zange

Intestinaux Forceps Pincés
Pinzas Pinzas intestinales

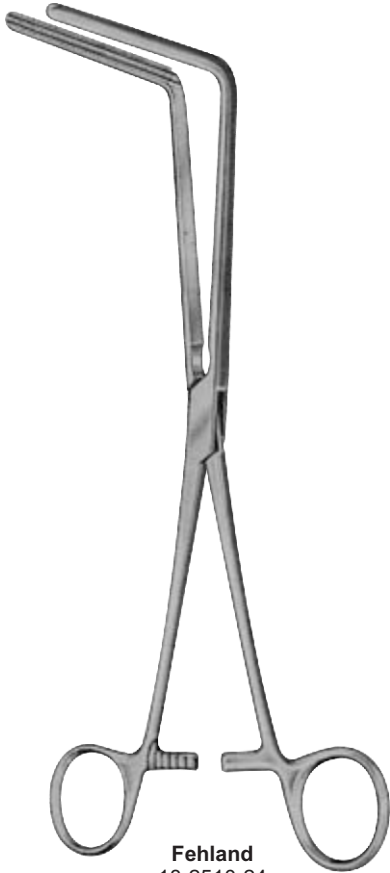

Fehland
18-2510-24
24 cm/9½"



Brunner
24 cm/9½"



18-2511-24

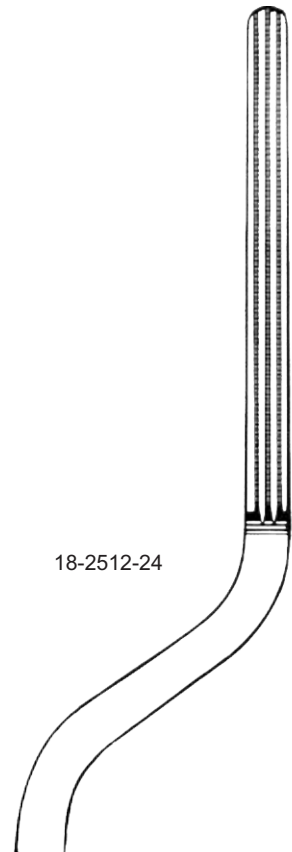

18-2512-24

Stomach, Intestine and Rectum Instruments

Intestinal Clamps Forceps
Darmklammern Zange

Intestinaux Forceps Pincers
Pinzas Pinzas intestinales



18

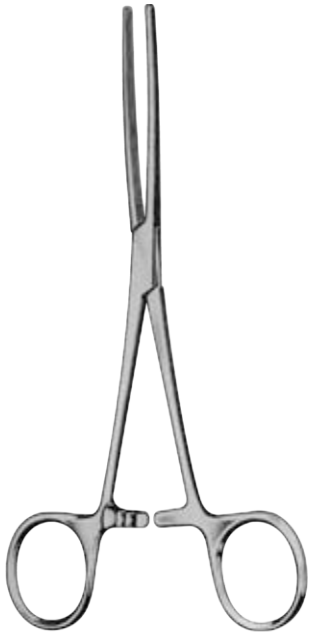

Baby-Kocher

18-2513-13
13 cm/5"

Straight
gerade
droit
recto

18-2514-13
13 cm/5"

Curved
Gebogene
courbe
Curvo



Kocher



18-2515-01
22 cm/8³/₄"



18-2515-02
25 cm/10"



18-2515-03
28 cm/11"



18-2515-04
22 cm/8³/₄"



18-2515-05
25 cm/10"

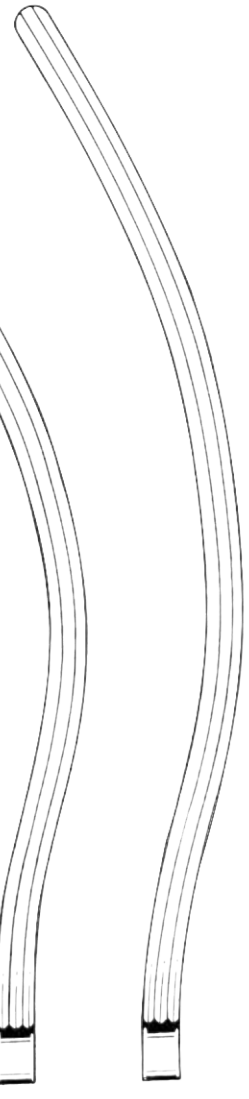

18-2515-06
28 cm/11"

Stomach, Intestine and Rectum Instruments

Atrauma Intestinal Clamps Forceps
Atrauma Darmklammern Zange

Atraumatique intestinaux Forceps Pinces
Atrauma Abrazaderas Pinzas intestinales



Kocher-Atrauma



18-2516-01
22 cm/8¾"

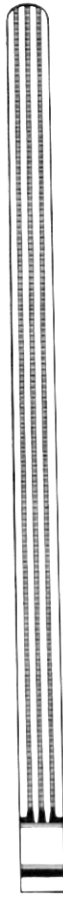

18-2516-02
25 cm/10"

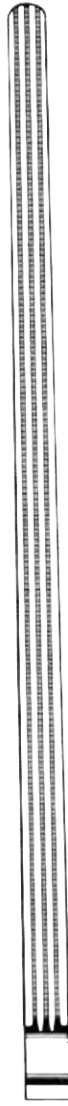

18-2516-03
28 cm/11"



18-2516-04
22 cm/8¾"

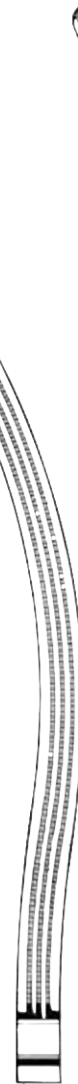

18-2516-05
25 cm/10"

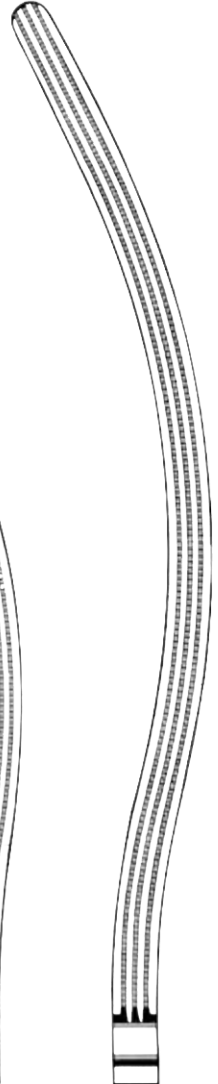

18-2516-06
28 cm/11"

Stomach, Intestine and Rectum Instruments

Intestinal Clamps Forceps
Darmklammern Zange

Intestinaux Forceps Pinces
Pinzas Pinzas intestinales



18



18-2517-25
Straight
gerade
droit
recto

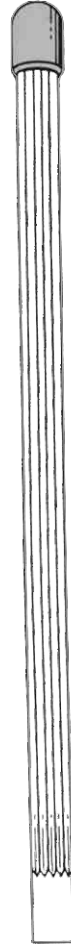

Nussbaum
25 cm/10"

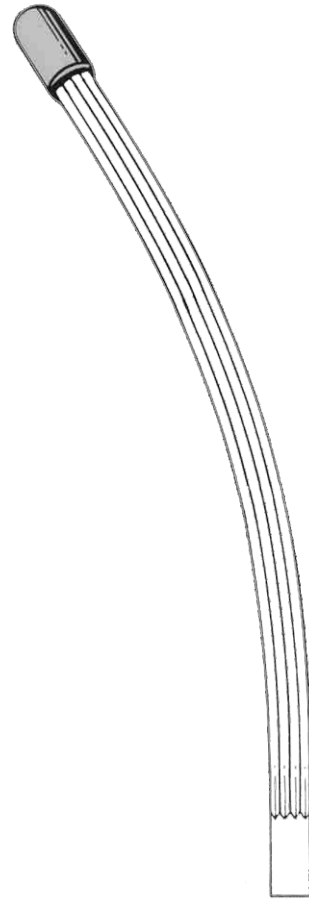

18-2518-25
Curved
Gebogene
courbe
Curvo

Pylorus spreader

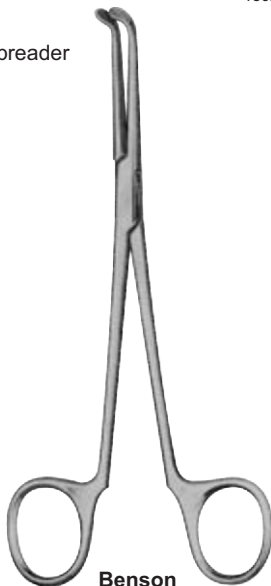

Benson
18-2519-15
15.5 cm/6"

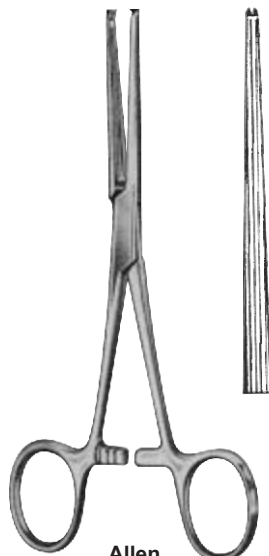

Allen
18-2520-15 15.5 cm/6"
18-2520-20 20.0 cm/8"

Blindgut forceps



Kleinschmidt
18-2521-12
12 cm/4¾"

Stomach, Intestine and Rectum Instruments

Intestinal and Stomach Clamps Forceps
Magen-und Klemmen Pinzetten

Intestinaux et de l'Estomac Forceps Pincés
Intestinales y el estómago Pinzas Pinzas

Twin Clamps Forceps
Doppelschlauchklemmen Forceps
Pincés Pincés jumeaux
Pinzas Pinzas Gemelas

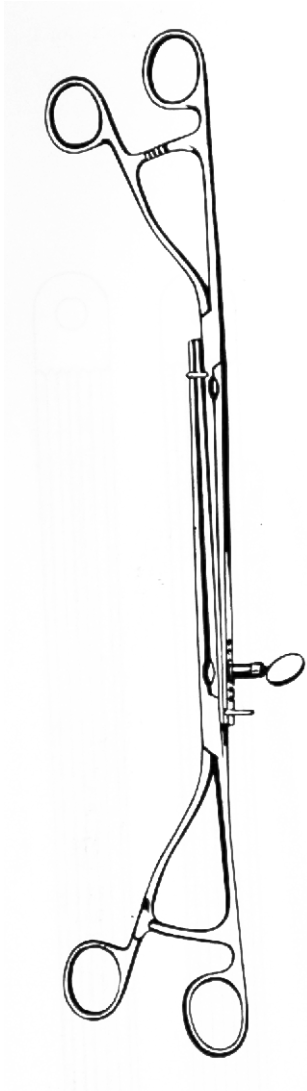

Lane
30 cm/12"



18-2526-30
Straight
gerade
droit
recto

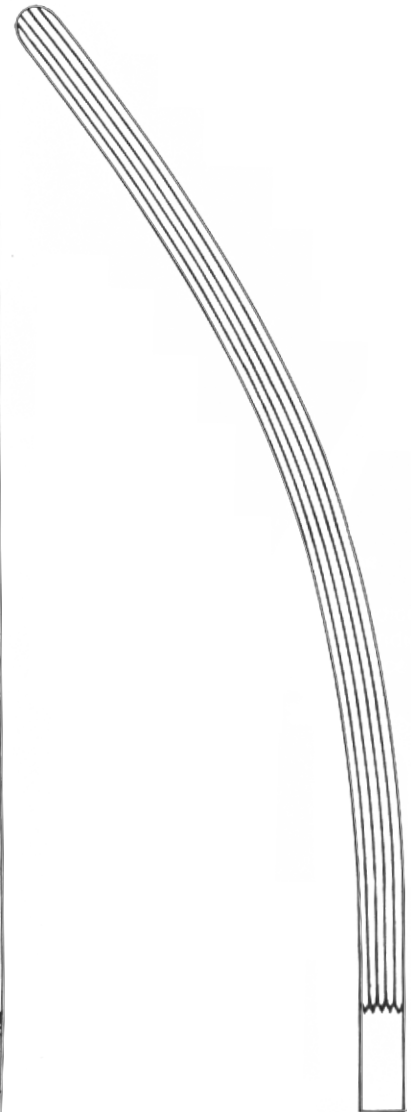

18-2527-30
Curved
Gebogene
courbe
Curvo

Stomach, Intestine and Rectum Instruments

Intestinal Stomach Clamps
Darm-Magen-Schellen

Pinces estomac intestinaux
Abrazaderas intestinales estómago



18



Payr
(Payr-Baby)

For children
für Kinder
pour les enfants
Para los niños



18-2528-15
15 cm/6"

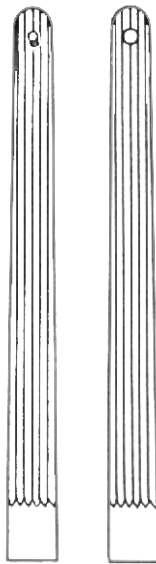

18-2529-21
21 cm/8¼"

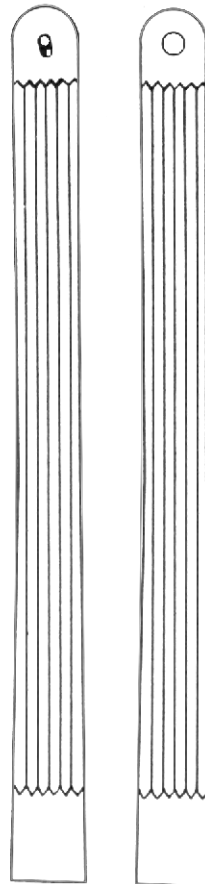

18-2530-29
29 cm/11½"

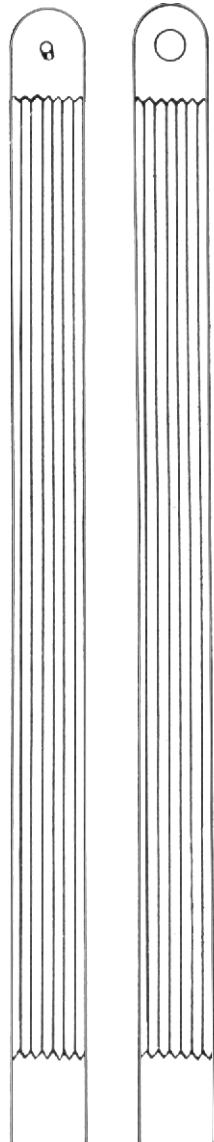

18-2531-35
35 cm/13¾"

Stomach, Intestine and Rectum Instruments

Atrauma Intestinal Forceps
Atrauma Darmklemmen

Pince atraumatique intestinaux
Atrauma Pinzas intestinales

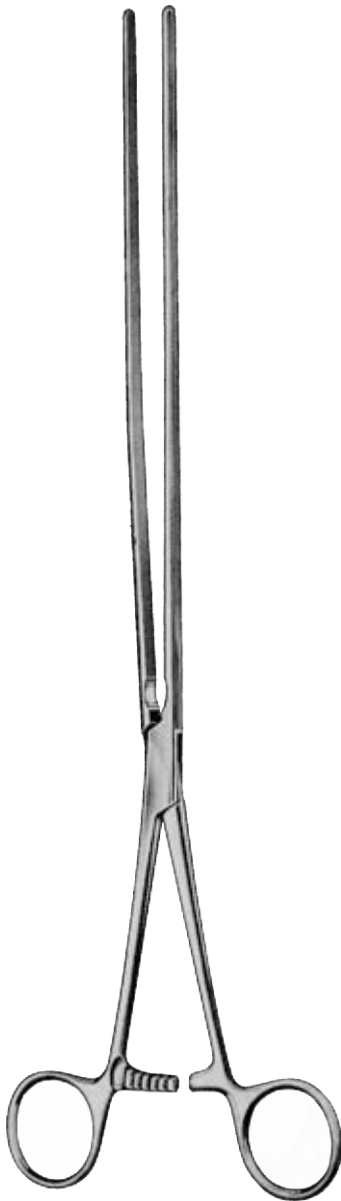

**Scudder
Scudder-Atraume**
33 cm/13"



18-2532-33
Straight
gerade
droit
recto

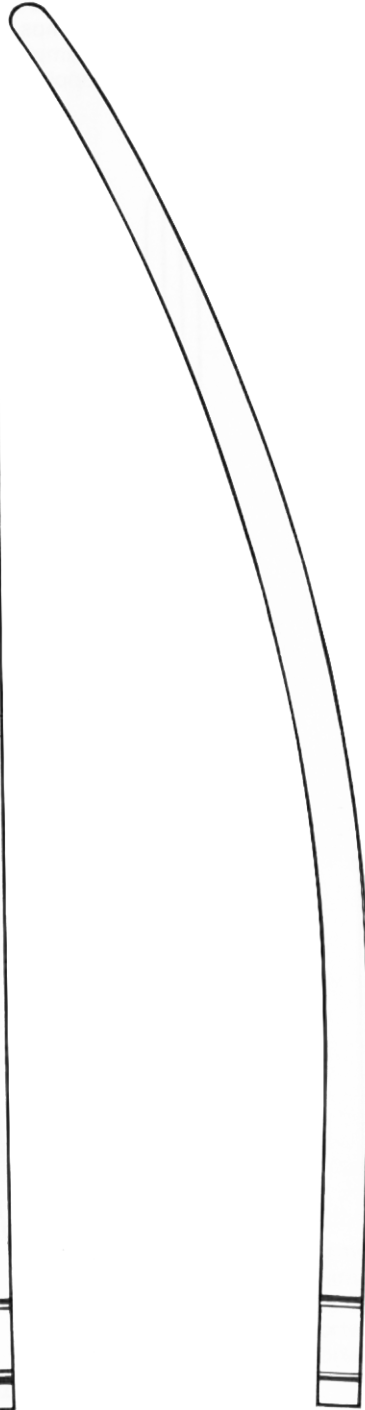

18-2533-33
Curved
Gebogene
courbe
Curvo

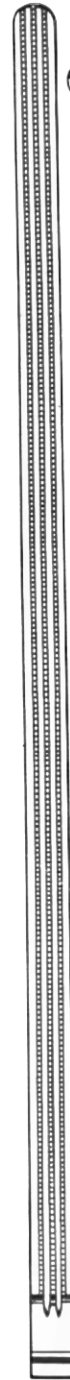

18-2534-33
Straight
gerade
droit
recto

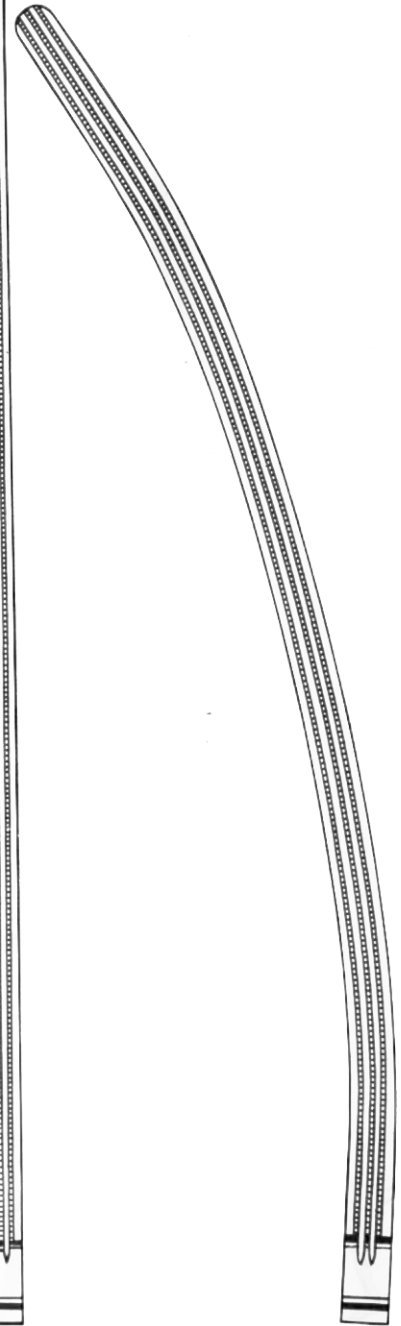

18-2535-33
Curved
Gebogene
courbe
Curvo

Stomach, Intestine and Rectum Instruments

Stomach Clamp Forceps
Magen Klammerzange

Estomac Forceps Clamp
Estómago pinza fórceps



18

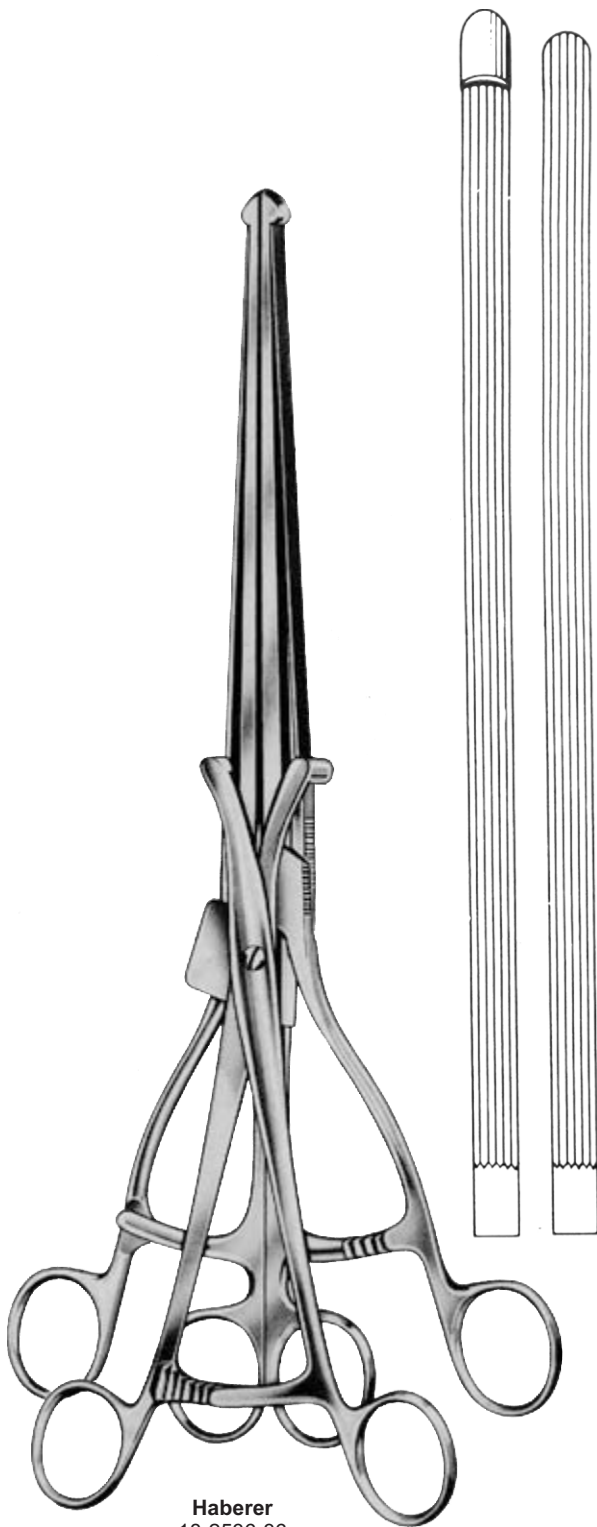

Haberer
18-2536-36
36 cm/14"

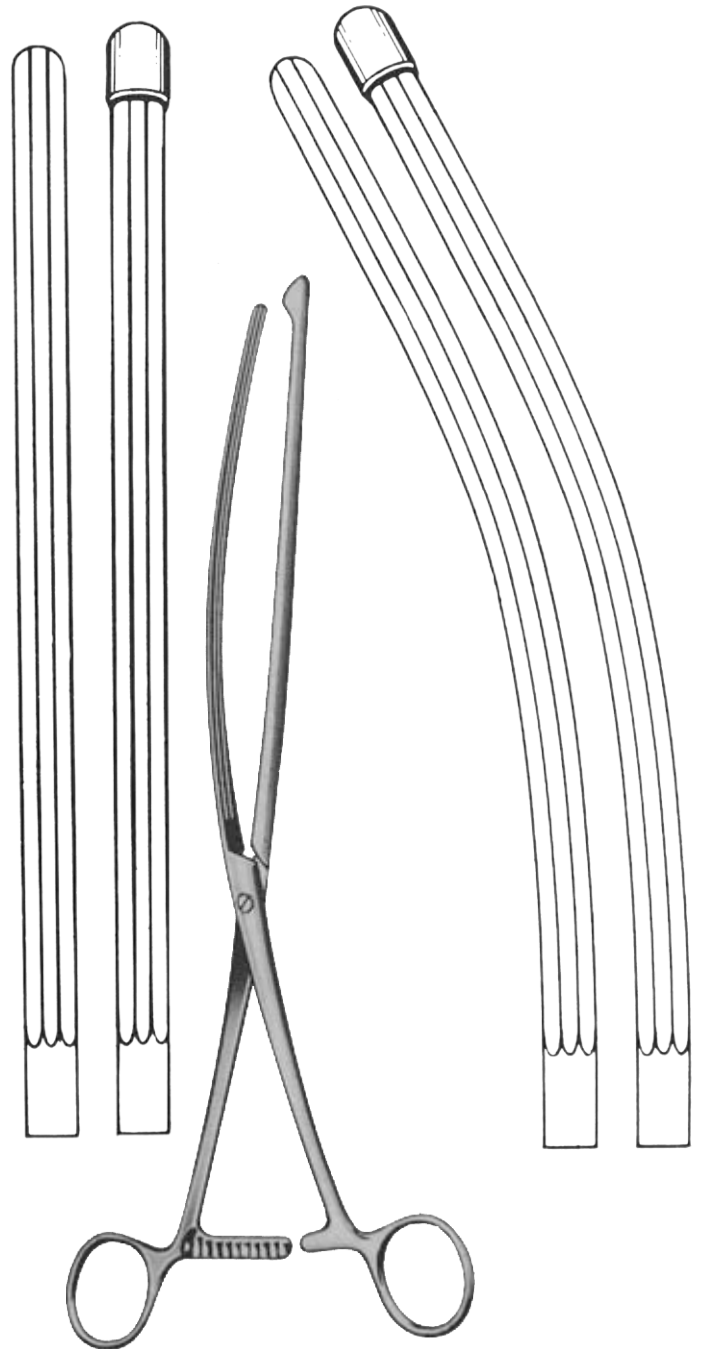

18-2537-01
Straight
gerade
droit
recto

Nussbaum
30 cm/12"

18-2537-02
Curved
Gebogene
courbe
Curvo

Intestine and Anastomosis

Clamps Forceps
Klemmen Pinzetten

Forceps Pincas
Pinzas Pinzas



De Martel-Wolfson
18-2538-05 5cm/2"
18-2538-07 7cm/2¾"
18-2538-10 10cm/4"

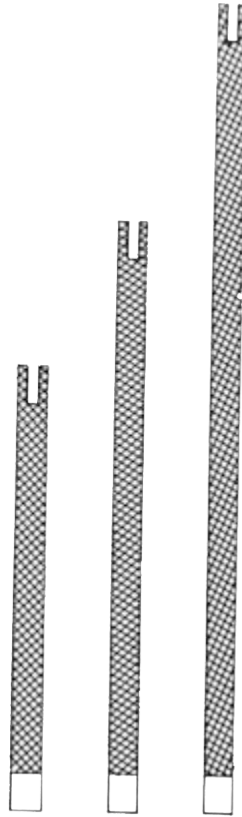

5 cm/2" 7 cm/2¾" 10 cm/4"

Set of 3 clamps
Set aus 3 Klemmen
Jeu de 3 pincas
Juego de 3 pinzas



De Martel-Wolfson
18-2539-00
26 cm/19¾"



De Martel-Wolfson
18-2540-08
8,5 cm/½"



De Martel-Wolfson
18-2541-23
23 cm/9"

Stomach, Intestine and Rectum Instruments

Rectal Speculas
Rektale Speculas

Speculas rectales
espéculos rectales



18

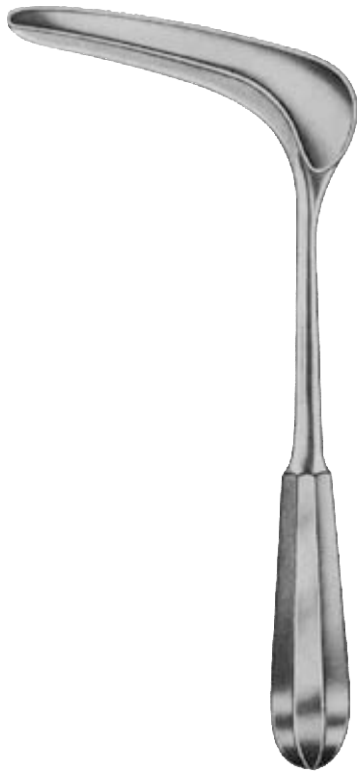

Czerny
18-2542-22
22 cm/8¾"



Sims
18-2543-15



Sims
18-2544-15
15 cm/6"



Pratt
18-2545-20
80 x 25 mm
20.5 cm/8"



Mathieu
18-2546-19
90 x 15 mm
19.5 cm/7¾"

Length of Blades
Länge der Klängen
Longueur des lames
Duración de Blades

- 18-2547-06
- 18-2547-08
- 18-2547-12
- 18-2547-15

- 60 mm
- 80 mm
- 125 mm
- 150 mm

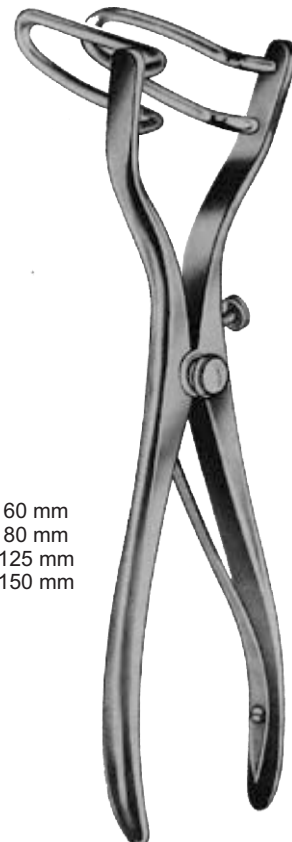

Stomach, Intestine and Rectum Instruments

Rectal Speculas, Anal Retractors and Anusopes
 Rektale Speculas, Anal Retraktoren und Anusopes

Speculas rectales, Rétracteurs Anal et Anusopes
 Espéculos rectales, Retractores Anal y Anusopes



Barr
 18-2548-17
 17 cm/6¾"
 70 X 22 mm



Anal Retractors
 anal Retraktoren
 écarteurs anaux
 écarteurs anaux...

75 x 23 mm

Smith-Bule
 18-2549-15
 15 cm/6"



Fig. 1 19 mm Ø x 70 mm
 Fig. 2 22 mm Ø x 70 mm

Bensaude
 18-2550-01
 18-2550-02



Fig. 1 16 mm Ø x 65 mm
 Fig. 2 19 mm Ø x 65 mm
 Fig. 3 22 mm Ø x 65 mm
 Fig. 4 25 mm Ø x 65 mm

Hirschmann
 18-2551-01
 18-2551-02
 18-2551-03
 18-2551-04

Stomach, Intestine and Rectum Instruments

Anal Retractors
Anal Retraktoren

Retracteurs Anal
Retractoros Anal



18

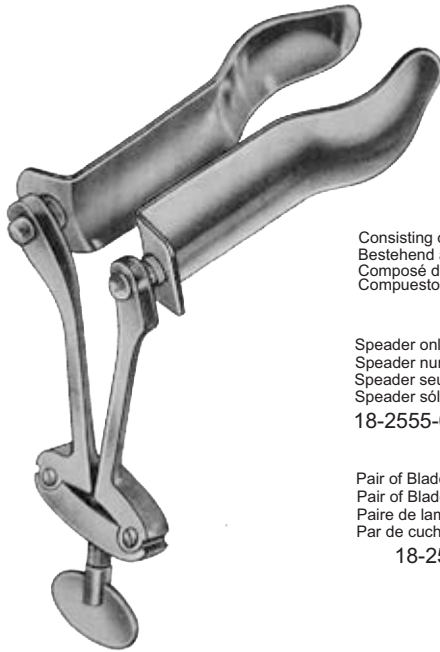

Park
18-2555-00
13 cm/5"

Consisting of:
Bestehend aus:
Composé de:
Compuesto por:

Spreader only
Spreader nur
Spreader seulement
Spreader sólo
18-2555-01

Pair of Blades only 95 mm
Pair of Blades nur 95 mm
Paire de lames seulement 95 mm
Par de cuchillas sólo 95 mm
18-2555-02

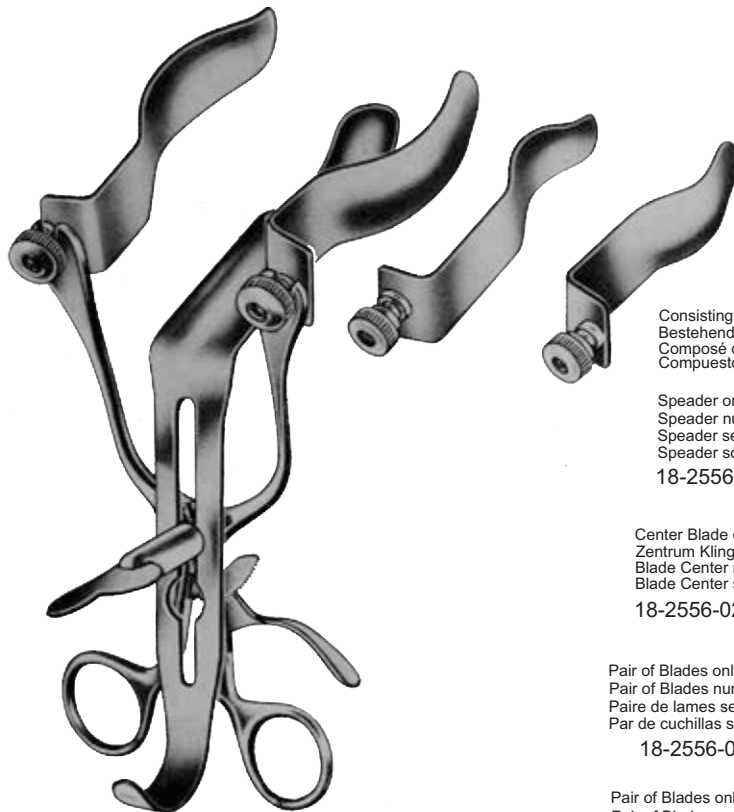

Park
18-2556-00
14.5 cm/5¾"

Consisting of:
Bestehend aus:
Composé de:
Compuesto por:

Spreader only
Spreader nur
Spreader seulement
Spreader sólo
18-2556-01

Center Blade only
Zentrum Klinge nur
Blade Center ne
Blade Center sólo
18-2556-02

Pair of Blades only 75 mm
Pair of Blades nur 75 mm
Paire de lames seulement 75 mm
Par de cuchillas sólo 75 mm
18-2556-03

Pair of Blades only 95 mm
Pair of Blades nur 95 mm
Paire de lames seulement 95 mm
Par de cuchillas sólo 95 mm
18-2556-04

Stomach, Intestine and Rectum Instruments

Anusopes, Proctoscopes and Sphincteroscopes
Anusopes, Proktoskope und Sphincteroscopes

Anusopes, les proctoscopes et Sphincteroscopes
Anusopes y proctoscopios y Sphincteroscopes



Kelly

Fig. 1 21 mm Ø 50 mm 18-2552-01
Fig. 2 27 mm Ø 50 mm 18-2552-02

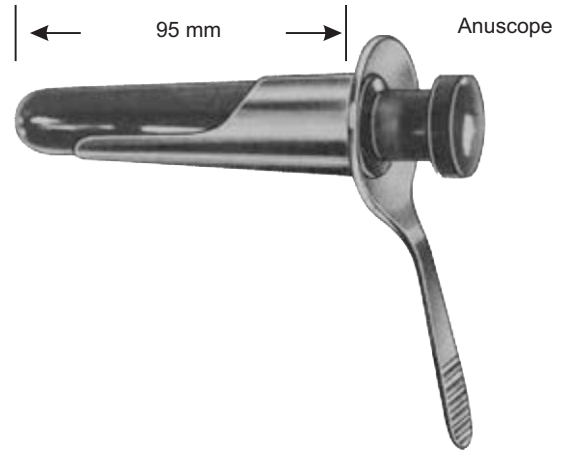

Ives-Fansler
18-2553-22
22 mm Ø

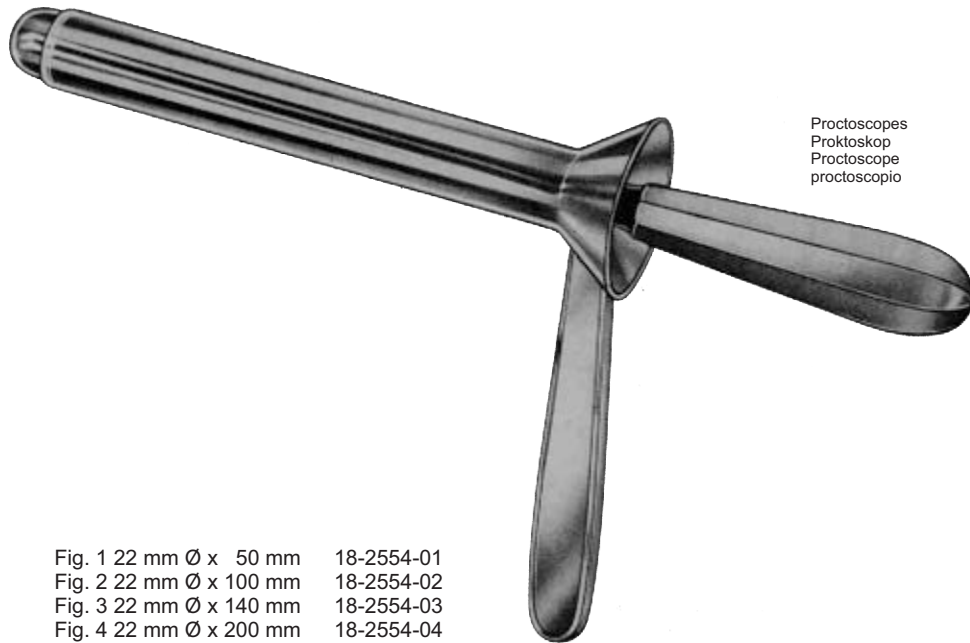

Proctoscopes
Proktoskop
Proctoscope
proctoscopio

Kelly

Fig. 1 22 mm Ø x 50 mm 18-2554-01
Fig. 2 22 mm Ø x 100 mm 18-2554-02
Fig. 3 22 mm Ø x 140 mm 18-2554-03
Fig. 4 22 mm Ø x 200 mm 18-2554-04

Stomach, Intestine and Rectum Instruments

Rectal Biopsy Specimen Forceps
Rektale Biopsie Zange

Pince biopsie rectale
Pinzas de biopsia rectal de muestras



18



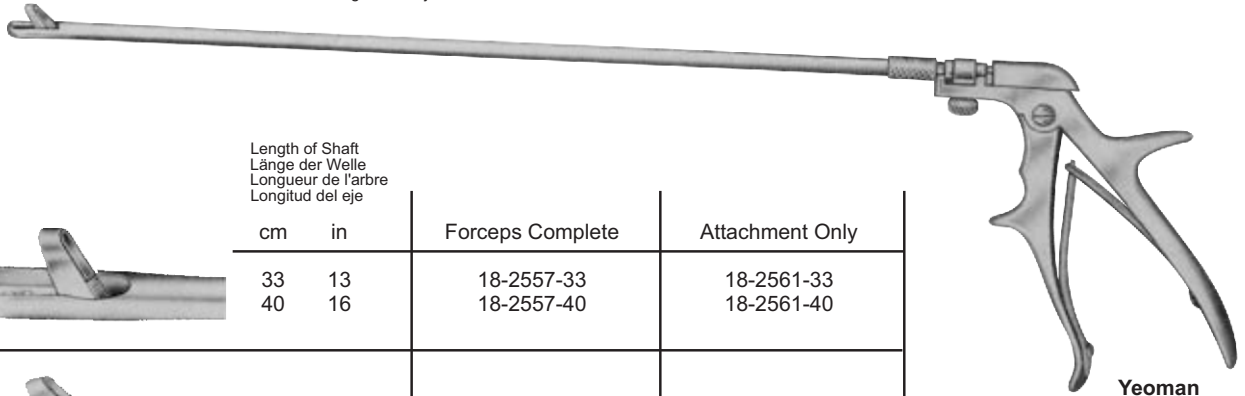

Length of Shaft
Länge der Welle
Longueur de l'arbre
Longitud del eje

Turnable
drehbare
Tournant
turnable



Yeoman (Turrell)

Handle Only
Handle nur
Manipulez uniquement
Manipular sólo
18-2561-00

	Length of Shaft Länge der Welle Longueur de l'arbre Longitud del eje		Forceps Complete	Attachment Only
	cm	in		
	33	13	18-2557-33	18-2561-33
	40	16	18-2557-40	18-2561-40
	33	13	18-2558-33	18-2562-33
	40	16	18-2558-40	18-2562-40
	33	13	18-2559-33	18-2563-33
	40	16	18-2559-40	18-2563-40
	33	13	18-2560-33	18-2564-33
	40	16	18-2560-40	18-2564-40

Length of Shaft
Länge der Welle
Longueur de l'arbre
Longitud del eje

Turnable
drehbare
Tournant
turnable

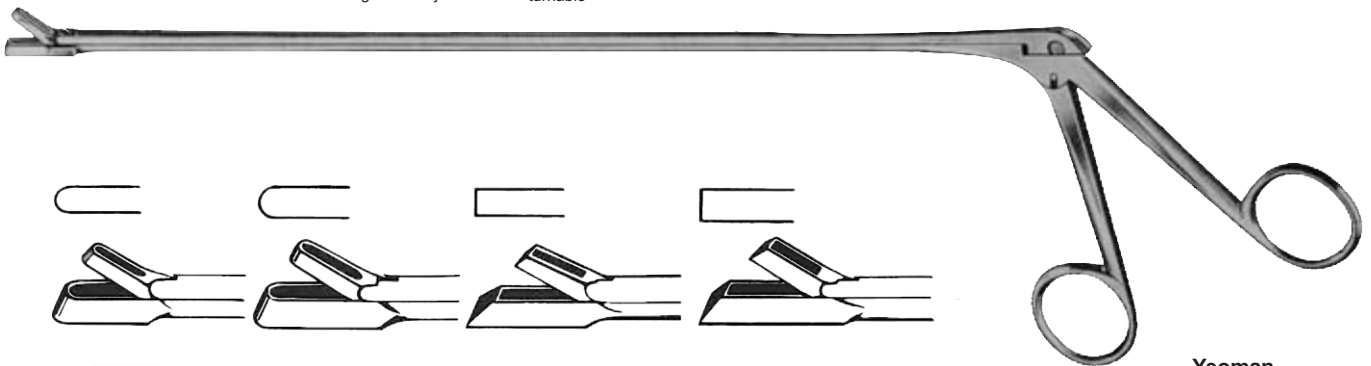

Yeoman

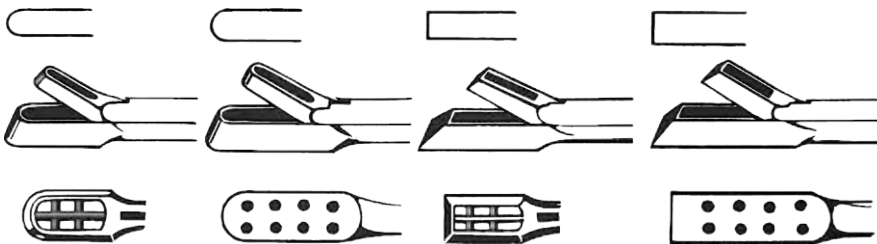

A	B	C	D
18-2565-28	18-2565-28	18-2565-28	18-2565-28
18-2565-35	18-2565-35	18-2565-35	18-2565-35
18-2565-42	18-2565-42	18-2565-42	18-2565-42

cm	in
28	11
35	13 ³ / ₄ "
42	16 ¹ / ₂ "

Stomach, Intestine and Rectum Instruments

Haemorrhoidal Forceps and Rectal Snares
Haemorrhoidal Pinzetten und Rectal Snares

Pince Haemorrhoidal et Snares rectales
Pinzas Haemorrhoidal y trampas rectales

Rectal Snare
rektale Snare
rectale piège
rectal trampa

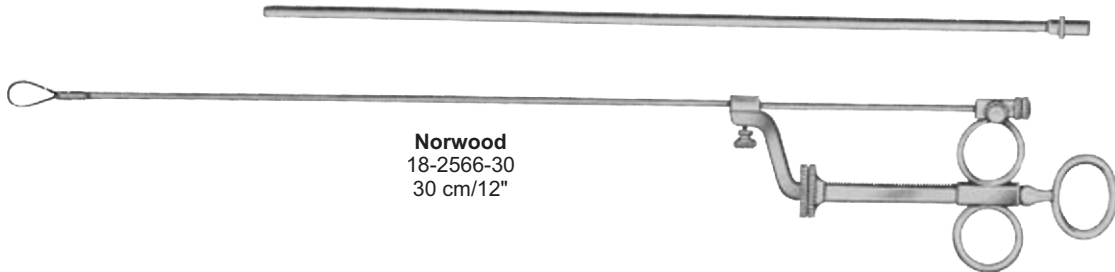

Norwood
18-2566-30
30 cm/12"

Rectal Aspiration Cannula
Rectal Aspirationskanüle
Canule aspiration rectale
Cánula de aspiración recto

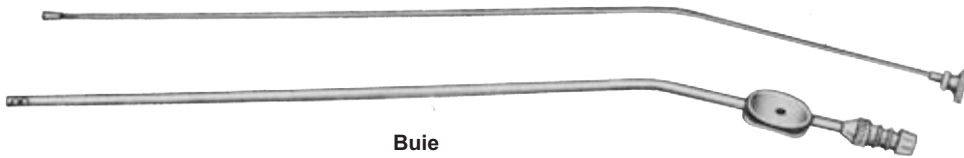

Buie
18-2567-40
Charr. 10. 40 cm/15¾"

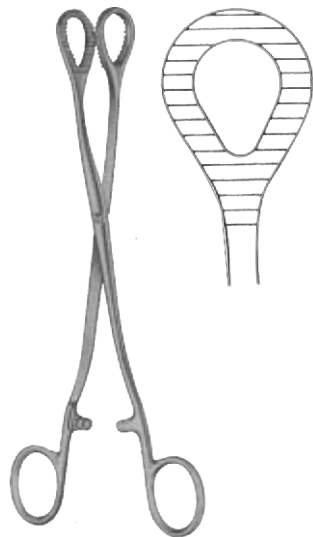

Heywood-Smith
18-2568-20
20 cm/8"

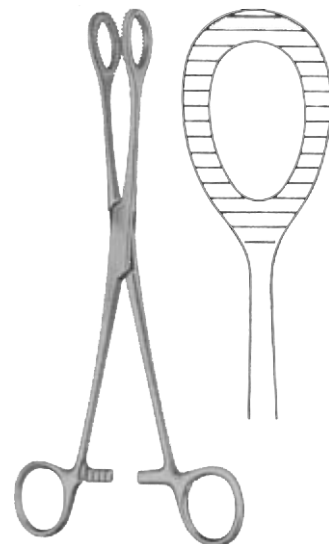

Heywood-Smith
18-2569-21
21 cm/8¼"

Stomach, Intestine and Rectum Instruments

Haemorrhoidal Ligators
Haemorrhoidal Ligatur

Ligators Haemorrhorial
Ligators Haemorrhorial



18

Aspiration Tip

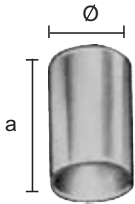

	a	Ø
18-2570-11	11 mm	10 mm
18-2570-16	16 mm	10 mm

Charging Cone



10 mm Ø

Charging Cone



12 mm Ø

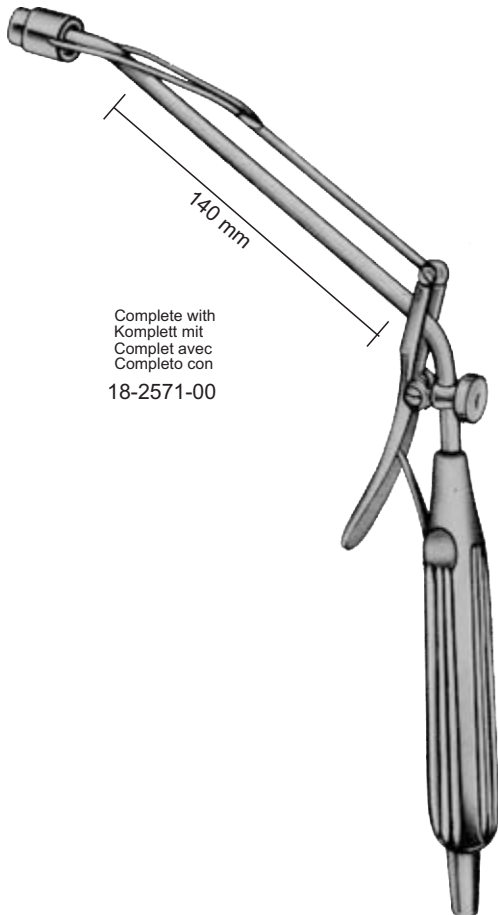

Complete with
Komplett mit
Complet avec
Completo con
18-2571-00

Migivney

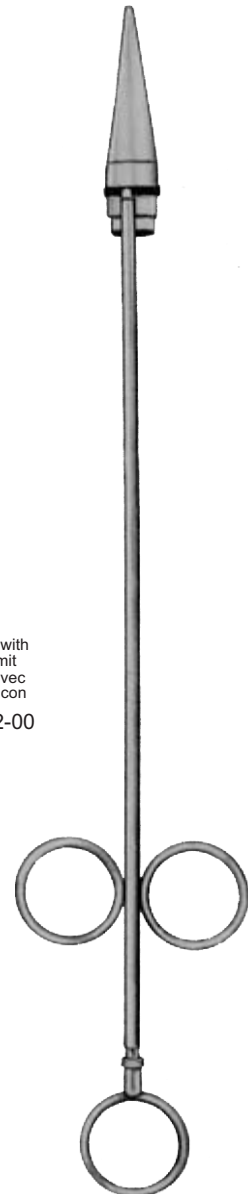

Complete with
Komplett mit
Complet avec
Completo con
18-2572-00

Rudd
31.5 cm/12½"

Dermatology Instruments

Comedone Extractors and Skin Currettes
Komedos Extraktoren und Haut-Küretten

Extracteurs comédon et Currettes de la peau
Extractores y comedones Curretas la piel

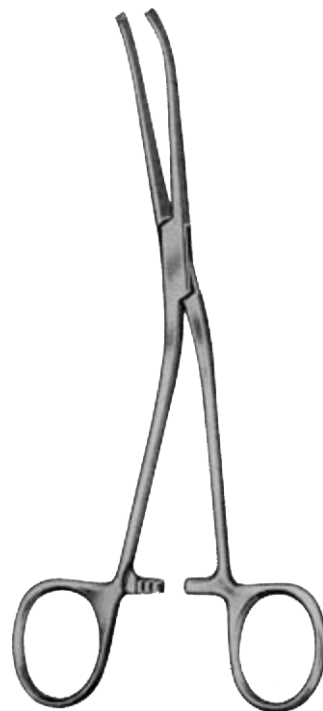
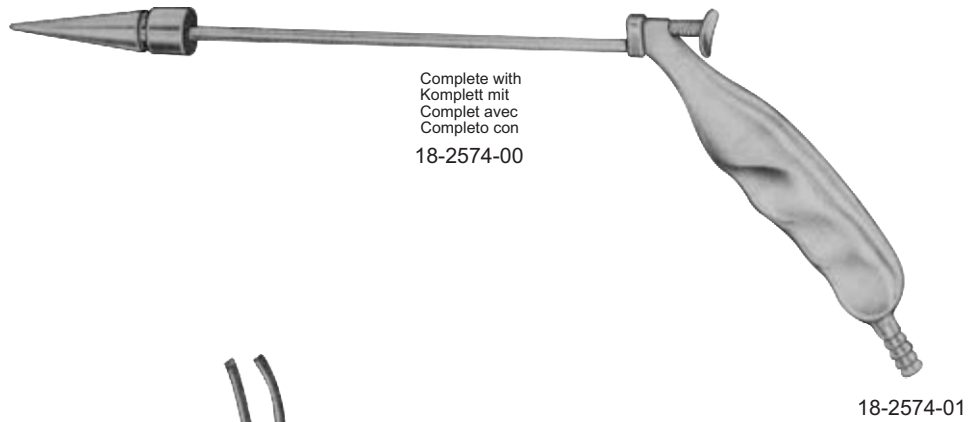
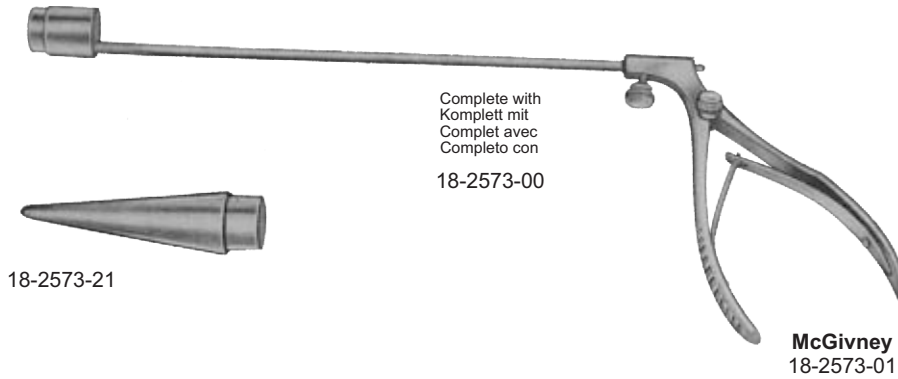

McGivney
18-2575-19
19 cm/7½"

Kidney, Liver and Gall Stone Instruments

Kidney Pedicle Clamps Forceps
Kidney Gestielte Klemmen Pinzetten

Rein périculaires Forceps Pincas
Pinzas Pinzas renales pediculares



19

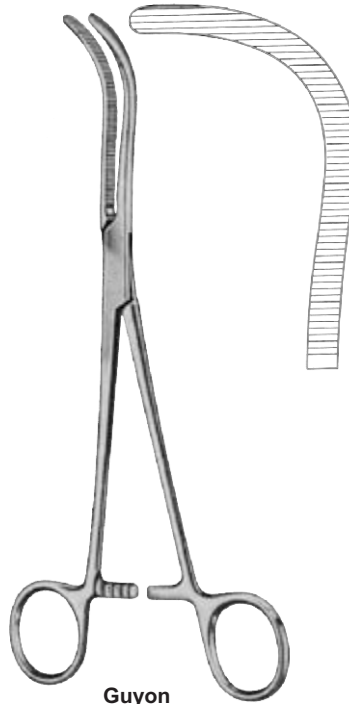

Guyon
19-2576-23
23 cm/9"

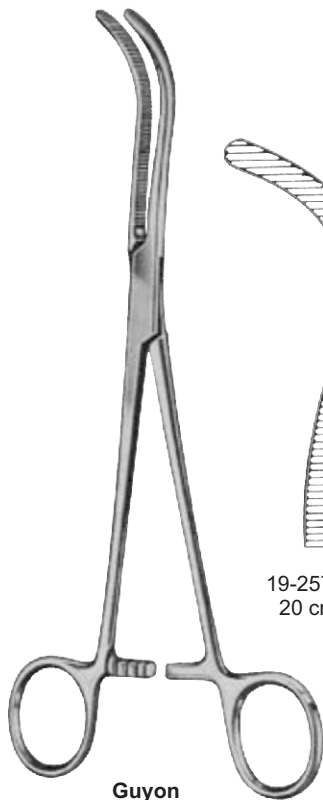

Guyon

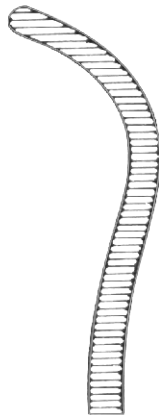

19-2577-20
20 cm/8"

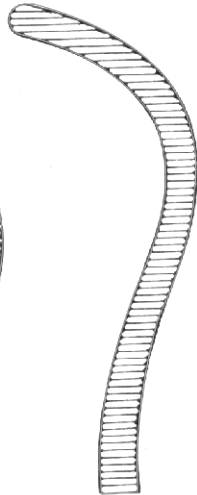

19-2577-22
22 cm/8¾"

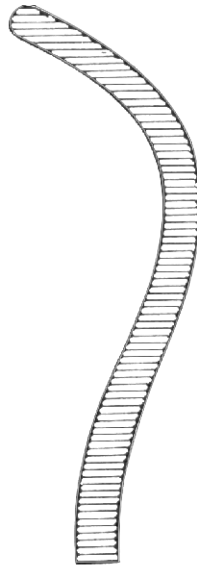

19-2577-24
24 cm/9½"



19-2578-23
23 cm/9"

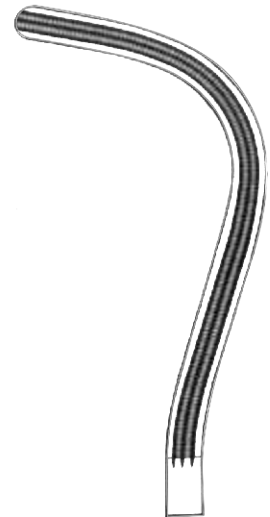

19-2579-24
24 cm/9½"

Kidney, Liver and Gall Stone Instruments

Kidney Pedicle Clamps Forceps
Kidney Gestielte Klemmen Pinzetten

Rein pédiculaires Forceps Pincas
Pinzas Pinzas renales pediculares

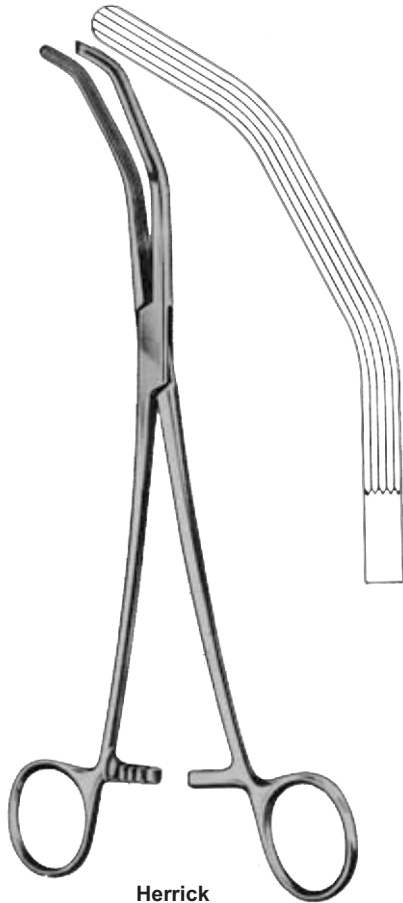

Herrick
19-2580-23
23 cm/9"

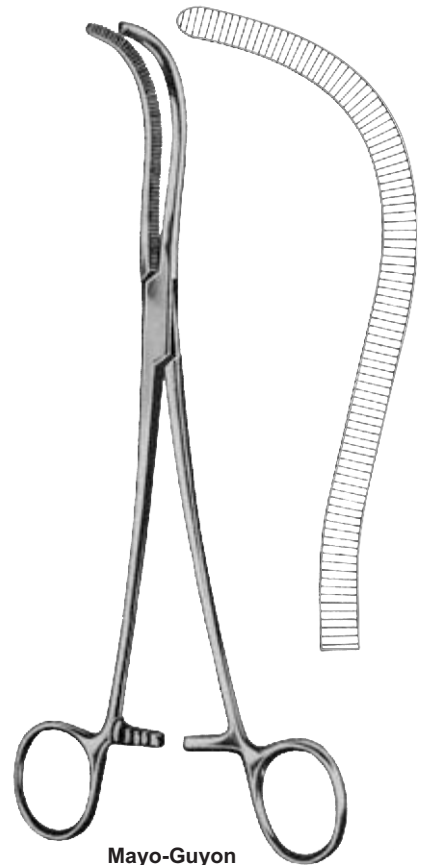

Mayo-Guyon
19-2581-23
23 cm/9"

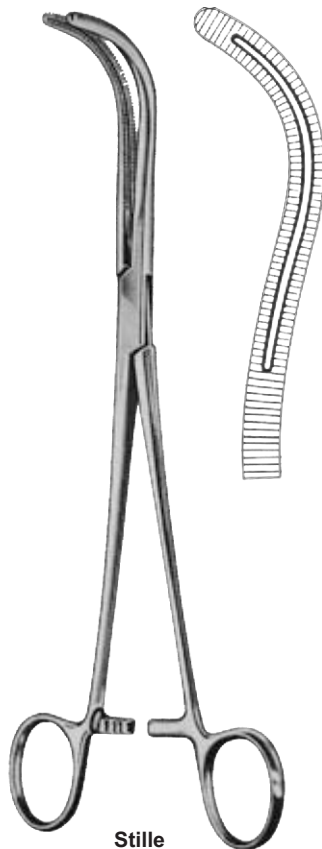

Stille
19-2582-23
23 cm/9"

Kidney, Liver and Gall Stone Instruments

Kidney Stone Forceps
Nierensteinzangen

Pince de calculs rénaux
Pinzas de cálculos renales



19

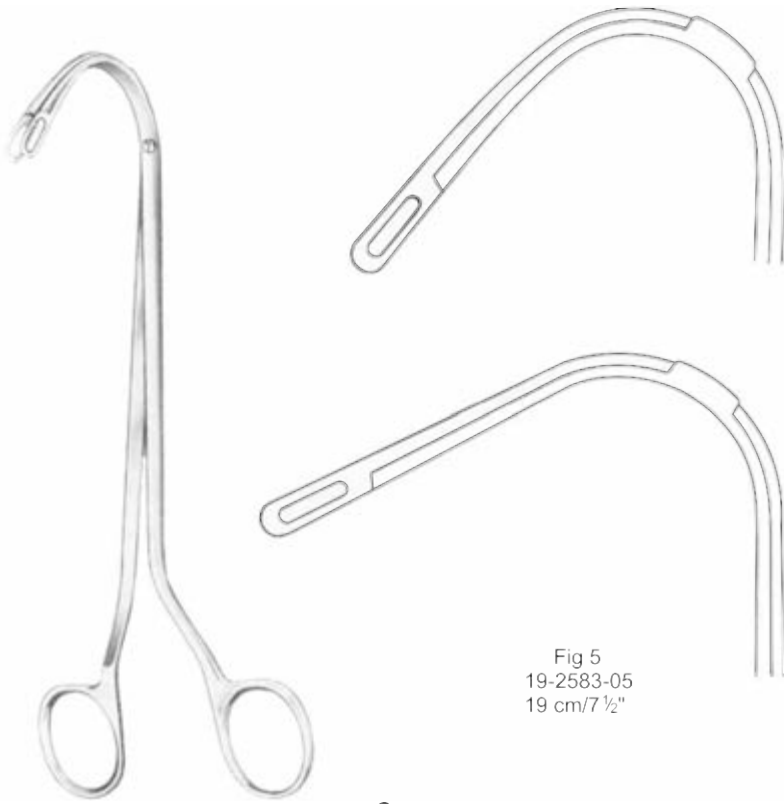

Fig 5
19-2583-05
19 cm/7 1/2"

Randall



Randall

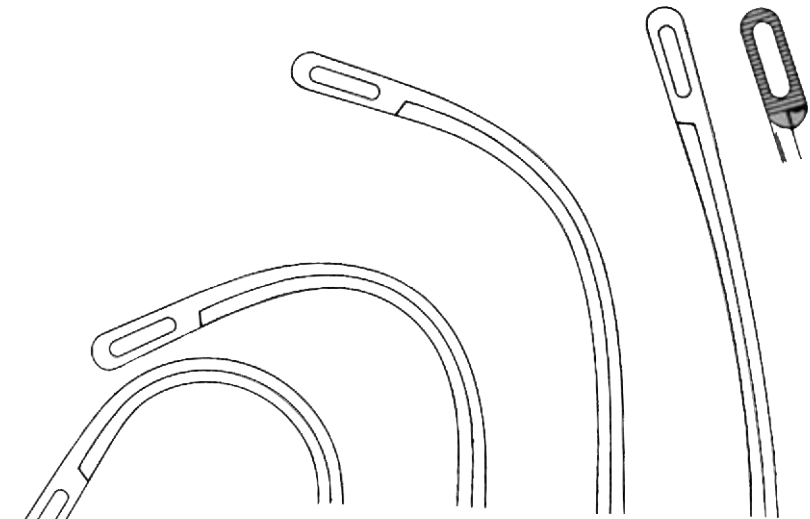

Fig. 4
19-2584-04
22 cm/8 3/4"

Fig. 3
19-2584-03
22 cm/8 3/4"

Fig. 2
19-2584-02
22 cm/8 3/4"

Fig. 1
19-2584-01
23 cm/9"

Kidney, Liver and Gall Stone Instruments

Gall Duct Forceps
Gallenwegefunktionsstörungen Zange

Pince conduits biliaires
Pinzas de conductos biliares



Gray

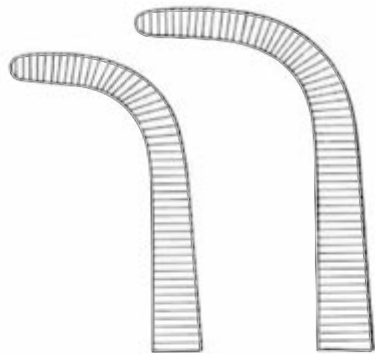

Fig. 1
19-2585-01
22 cm/8¾"

Fig. 2
19-2585-02
23 cm/9"



Gray

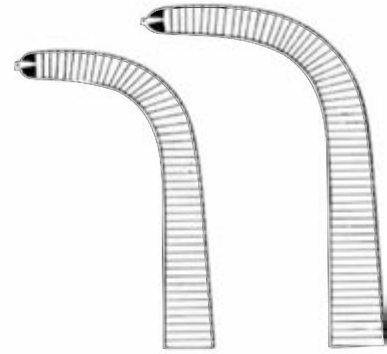

Fig. 1
19-2586-01
22 cm/8¾"

Fig. 2
19-2586-02
23 cm/9"

Gall duct and cystic forceps
Gall Kanal und zystische Pi
Conduit biliaire et pince kys
Gall conducto y fórceps qu



Desjardins
19-2587-21
21 cm/8¼"

Nissen
19-2588-21
21.5 cm/8½"

Kidney, Liver and Gall Stone Instruments

Gall Stone Forceps
Gallenstein Zange

Pince lithiase vésiculaire
Pinzas de cálculos biliares

19



19-2589-20 **Blake** 20 cm/8" 19-2591
Straight gerade droit recto
Curved Gebogene courbé Curvo



19-2591-20 **Mayo-Blake** 20 cm/8" 19-2592-20
Straight gerade droit recto
Curved Gebogene courbé Curvo



Czerny
19-2593-24
24.5 cm/9¾"



Desjardins
23 cm/9"



Fig. 1
19-2594-01



Fig. 2
19-2595-02

Kidney, Liver and Gall Stone Instruments

Gall Stone Probes and Bile Duct Dilators
Gallenstein-Sonden und Gallengang Dilatoren

Sondes lithiase vésiculaire et Dilateurs des canaux biliaires
Sondas de cálculos en la vesícula y los dilatadores de los Conductos Biliares

Elastic



19-2596-01



19-2596-02



19-2596-03



Desjardins
28 cm/11"

Bile duct dilators.



Bakes
30 cm/12"

mm	
1	19-2597-01
2	19-2597-02
3	19-2597-03
4	19-2597-04
5	19-2597-05
6	19-2597-06
7	19-2597-07
8	19-2597-08
9	19-2597-09
10	19-2597-10
11	19-2597-11
12	19-2597-12
13	19-2597-13

19-2597-00

Set of 9 pieces
Satz von 9 Stück
ensemble de 9 pièces
juego de 9 piezas

19-2597-03 to 19-2597-11

19-2598-00

Set of 9 pieces in canvas pocket
Satz von 9 Stück in der Leinwand Tasche
ensemble de 9 pièces dans la poche de toile
conjunto de 9 piezas en bolsa de lona

Kidney, Liver and Gall Stone Instruments

Gall Stone Scoops
Gallenstein Scoops

Gall Pierre Scoops
Gall Stone Scoops



19

Elastic



Desjardins
30 cm/12"



Fig.1
19-2599-01



Fig.2
19-2599-02



Fig.3
19-2599-03



Fig.4
19-2599-04

Malleable
formbar
malléable
maleable



Luer-Koerte
32 cm/12½"



19-2600-02
2.5 mm



19-2600-03
3.2 mm



19-2600-04
4.2 mm



19-2600-05
5.5 mm



19-2600-06
6.7 mm



19-2600-08
8.0 mm



19-2600-11
11 mm



19-2600-15
15 mm

Kidney, Liver and Gall Stone Instruments

Gall Stone Scoops
Gallenstein Scoops

Gall Pierre Scoops
Gall Stone Scoops

Malleable
formbar
malléable
maleable



Mayo
19-2601-28
28 cm/11"



Mayo
26.5 cm/10½"



Fig. 1
19-2602-01



Fig. 2
19-2602-02



Fig. 3
19-2602-03

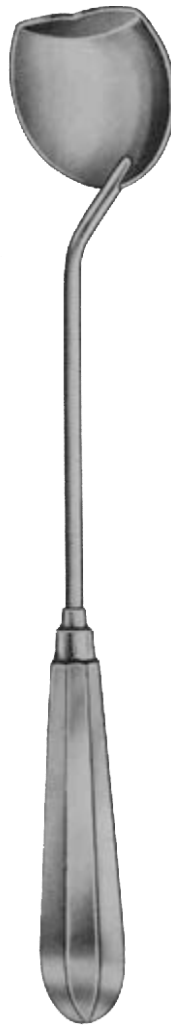

Moore
19-2603-28
28 cm/11"

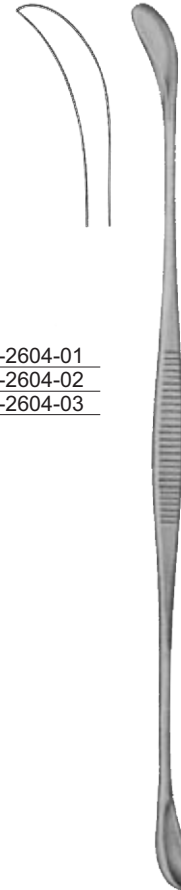
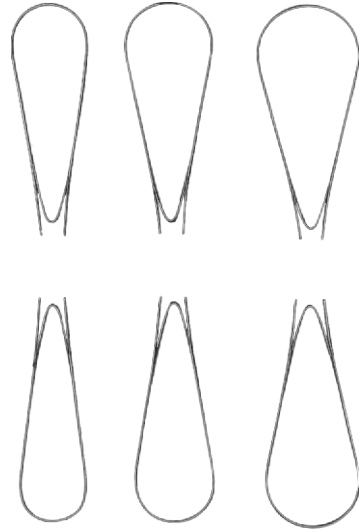

Fergusson
24 cm/9½"

Fig.
1 19-2604-01
2 19-2604-02
3 19-2604-03

Bladder and Urology Instruments

Prostatic Retractors and Prostatic Lobe Holding Forceps

Prostata und Prostata-Reraktoren Lobe Haltezange

Rétracteurs prostatiques et de la prostate Davier à lobes

Los retractores de la Próstata y pinzas de sujeción del lóbulo de la Próstata

19



Young
19-2605-21
21 cm/8 1/4"



Young
19-2606-22
22 cm/8 3/4"



Young
19-2607-21
21 cm/8 1/4"



Young
19-2608-22
22 cm/8 3/4"

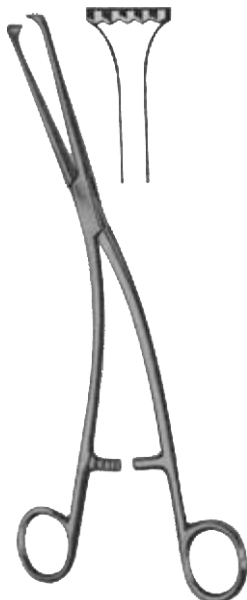

Millin
19-2609-23
23 cm/9"



Millin
19-2610-23
23 cm/9"



Millin
19-2611-23
23 cm/9"

Bladder and Urology Instruments

Bladder Retractors
Blasen-Wundhaken

rétracteurs de la vessie
Los retractores de vejiga



Millin
19-2612-28
28.5 cm/11 1/4"

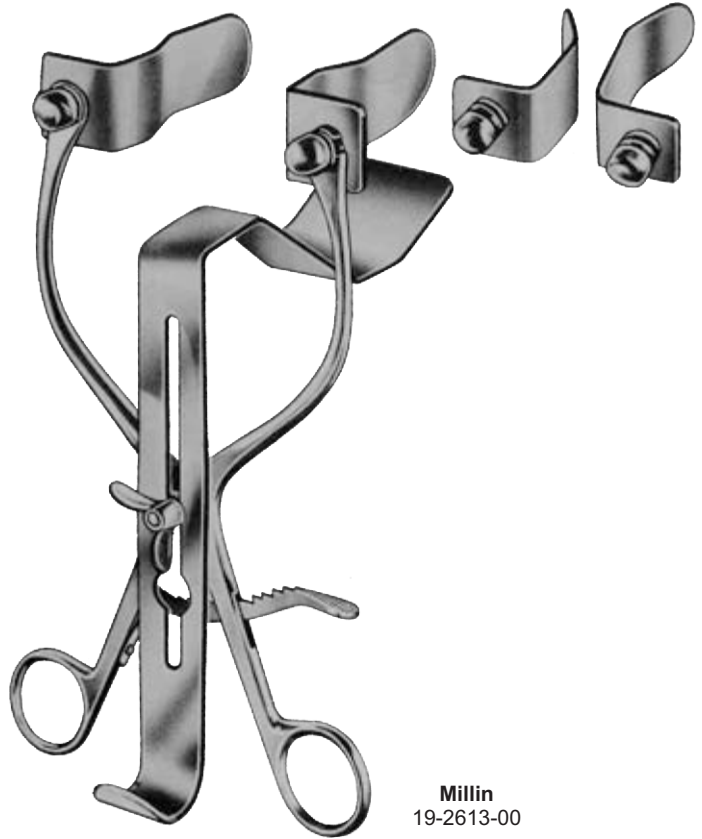

Millin
19-2613-00

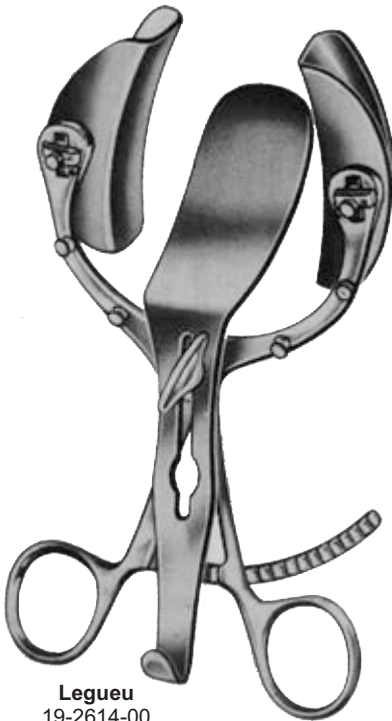

Legueu
19-2614-00

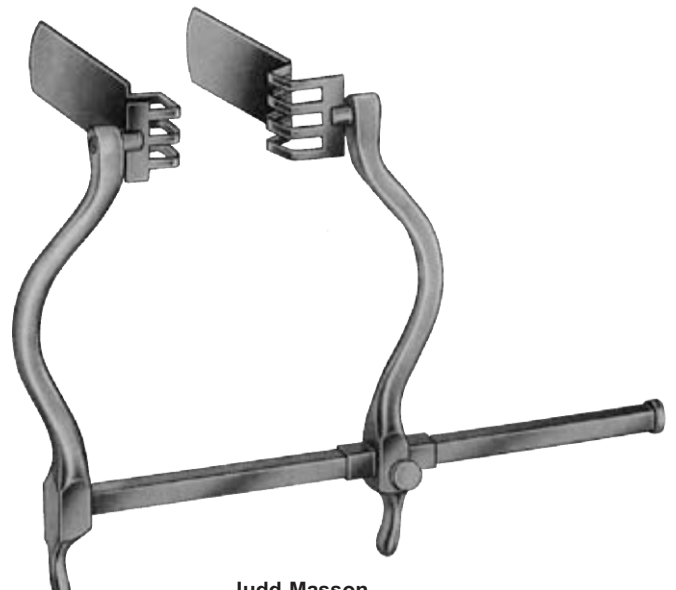

Judd-Masson
19-2615-00

Bladder and Urology Instruments

Bladder Retractors
Blasen-Wundhaken

rétracteurs de la vessie
Los retractores de vejiga



19

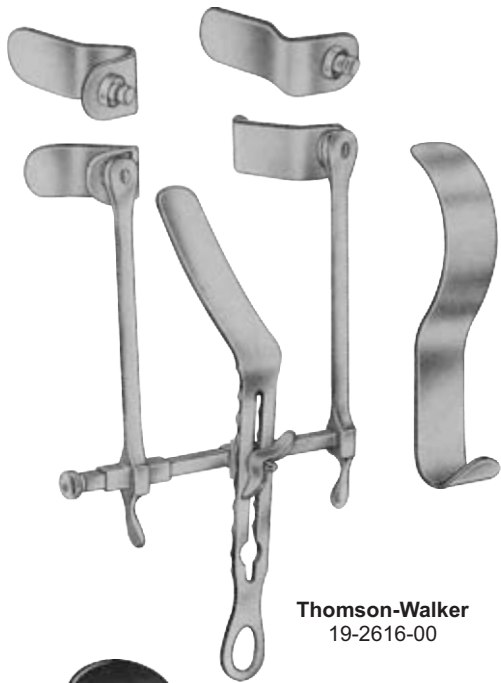

Thomson-Walker
19-2616-00

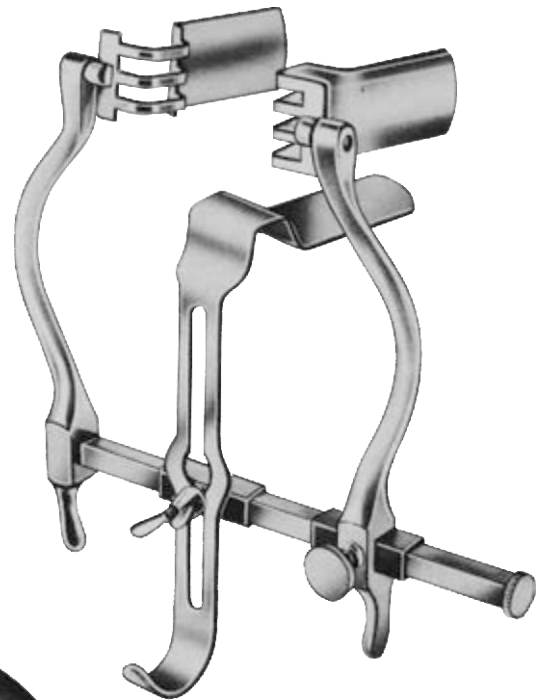

Judd-Masson
19-2617-00



Legueu
19-2618-27
27 cm/10½"
35 mm



Kocher
19-2619-26
26 cm/10¼"
67 mm

Bladder and Urology Instruments

 Dilating Bougies
 Dehn-Bougies

 Bougies de dilatation
 bujías de dilatación

 mm Ø **Charriere
(French)**

2 ² / ₃	8
3	9
3 ¹ / ₃	10
3 ² / ₃	11
4	12
4 ¹ / ₃	13
4 ² / ₃	14
5	15
5 ¹ / ₃	16
5 ² / ₃	17
6	18
6 ¹ / ₃	19
6 ² / ₃	20
7	21
7 ¹ / ₃	22
7 ² / ₃	23
8	24
8 ¹ / ₃	25
8 ² / ₃	26
9	27
9 ¹ / ₃	28
9 ² / ₃	29
10	30
10 ¹ / ₃	32
11 ² / ₃	34
12	36



Van Buren
 Charrier (French)
 No. 8-36
 19-2620-08
 19-2620-36
 28 cm/11"

In Canvas Pouch
 19-2620-50
 Set of 6
 6 Pcs. 19-2620-14/24

19-2620-60
 Set of 12
 12 Pcs 19-2620-08/30

19-2620-08
19-2620-10
19-2620-12
19-2620-14
19-2620-16
19-2620-18
19-2620-20
19-2620-22
19-2620-24
19-2620-26
19-2620-28
19-2620-30
19-2620-32
19-2620-34
19-2620-36



Dittel
 Charriere (French)
 No. 8-30
 19-2621-08
 19-2621-30
 19.5 cm/7 1/2"

19-2621-08
19-2621-09
19-2621-10
19-2621-11
19-2621-12
19-2621-13
19-2621-14
19-2621-15
19-2621-16
19-2621-17
19-2621-18
19-2621-19
19-2621-20
19-2621-21
19-2621-22
19-2621-23
19-2621-24
19-2621-25
19-2621-26
19-2621-27
19-2621-28
19-2621-26
19-2621-30

 Straight
 gerade
 droit
 recto

Dittel
 Charriere (French)
 No. 8-30
 19-2622-08
 19-2622-30
 34.5 cm/13 1/2"

19-2622-08
19-2622-09
19-2622-10
19-2622-11
19-2622-12
19-2622-13
19-2622-14
19-2622-15
19-2622-16
19-2622-17
19-2622-18
19-2622-19
19-2622-20
19-2622-21
19-2622-22
19-2622-23
19-2622-24
19-2622-25
19-2622-26
19-2622-27
19-2622-28
19-2622-26
19-2622-30

 Curved
 Gebogene
 courbé
 Curvo

Bladder and Urology Instruments

Metal Catheters and Introducers
Metall-Katheter und Tubuswechsler

Cathéters métalliques et introducteurs
Los catéteres de metal e introductores



19

For men



19-2623-06
19-2623-24

For Women



	mm Ø	Charriere (French)	
19-2623-06	2	6	19-2624-06
19-2623-07	2 $\frac{1}{3}$	7	19-2624-07
19-2623-08	2 $\frac{2}{3}$	8	19-2624-08
19-2623-09	3	9	19-2624-09
19-2623-10	3 $\frac{1}{3}$	10	19-2624-10
19-2623-11	3 $\frac{2}{3}$	11	19-2624-11
19-2623-12	4	12	19-2624-12
19-2623-13	4 $\frac{1}{3}$	13	19-2624-13
19-2623-14	4 $\frac{2}{3}$	14	19-2624-14
19-2623-15	5	15	19-2624-15
19-2623-16	5 $\frac{1}{3}$	16	19-2624-16
19-2623-17	5 $\frac{2}{3}$	17	19-2624-17
19-2623-18	6	18	19-2624-18
19-2623-19	6 $\frac{1}{3}$	19	19-2624-19
19-2623-20	6 $\frac{2}{3}$	20	19-2624-20
19-2623-21	7	21	19-2624-21
19-2623-22	7 $\frac{1}{3}$	22	19-2624-22
19-2623-23	7 $\frac{2}{3}$	23	19-2624-23
19-2623-24	8	24	19-2624-24

Catheter Introducing Instruments



Guyon
19-2625-39
39 cm/15 $\frac{1}{2}$ "



Guyon
19-2626-35
35 cm/13 $\frac{3}{4}$ "

Bladder and Urology Instruments

Metal Catheters and Cannula
Metall-Katheter und Kanülen

Cathéters métalliques et la canule
Catéteres de metal y la cánula



Bozemann-Fritsch
19-2627-08 8mm
19-2627-10 10mm
19-2627-12 12mm



Rotunda Hospital
19-2628-05 8 eg 5 mm
19-2628-06 10 eg 6mm



Carton
19-2629-05 5mm
30cm/12"



Spackmann
19-2634-00



Drew Smythe
19-2630-00



Hayes Provis
19-2631-00



Spackmann
19-2632-00
18 cm/7"



Provis Intra
19-2633-00

Bladder and Urology Instruments

Urology Introducers
Urologie Tubuswechsler

urologie Introduceurs
Urología Introduceores



19

Circumcision Instruments

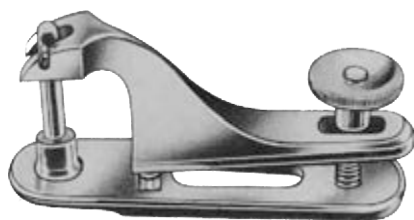

19-2635-08	08 mm
19-2635-11	11 mm
19-2635-13	13 mm
19-2635-16	16 mm
19-2635-21	21 mm
19-2635-26	26 mm
20-0200-32	32 mm

Foreign Body Forceps



Mathieu
19-2636-28
28 cm/11"

Penis Clamps

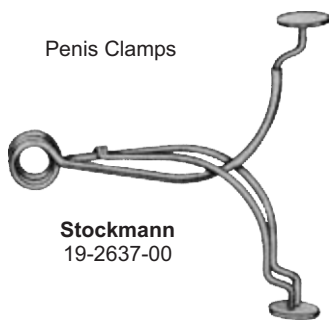

Stockmann
19-2637-00

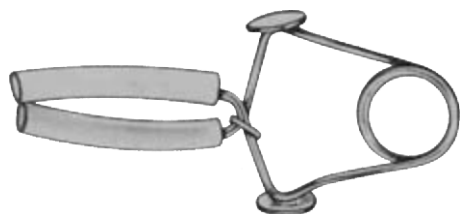

Strauss
19-2638-00

Secretion Scoop



Guttman
19-2639-26
26.5 cm/10½"

Gynecology Instruments

Vaginal Speculas
Vaginal Speculas

Speculas vaginales
especulos vaginales

Scheme of Dimensions for Specula

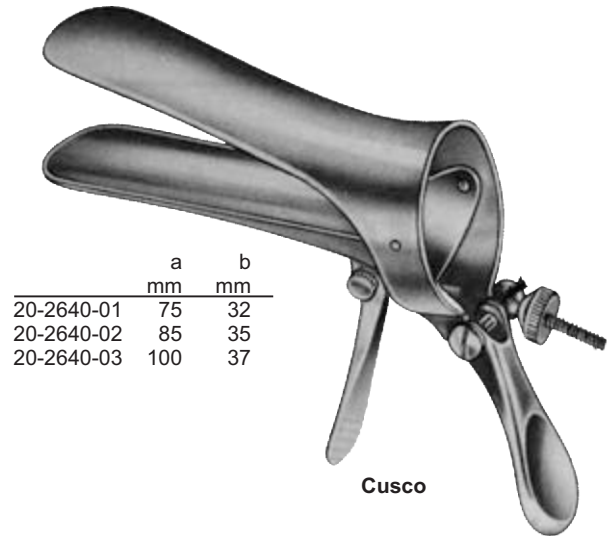
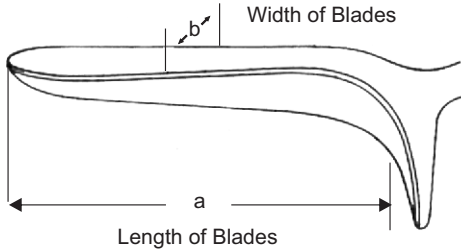

	a mm	b mm
20-2640-01	75	32
20-2640-02	85	35
20-2640-03	100	37

Cusco

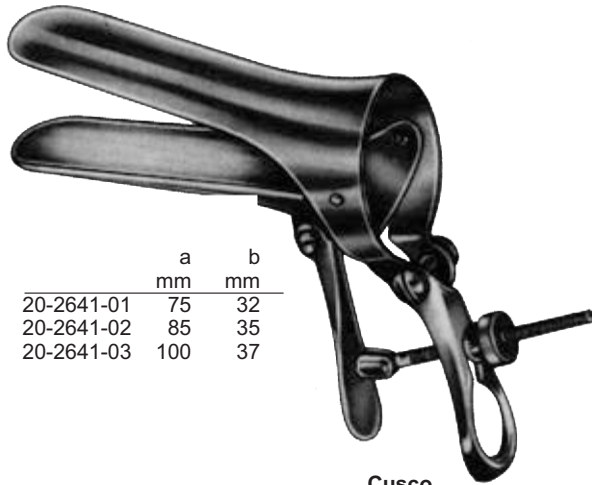

	a mm	b mm
20-2641-01	75	32
20-2641-02	85	35
20-2641-03	100	37

Cusco

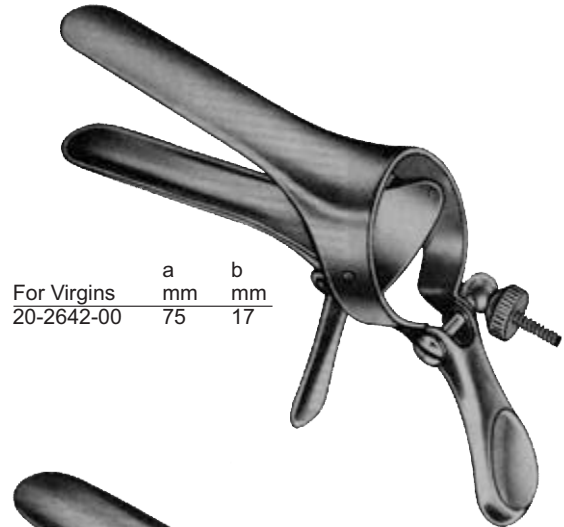

For Virgins	a mm	b mm
20-2642-00	75	17

Cusco



For Virgins	a mm	b mm
20-2643-00	75	17

Cusco

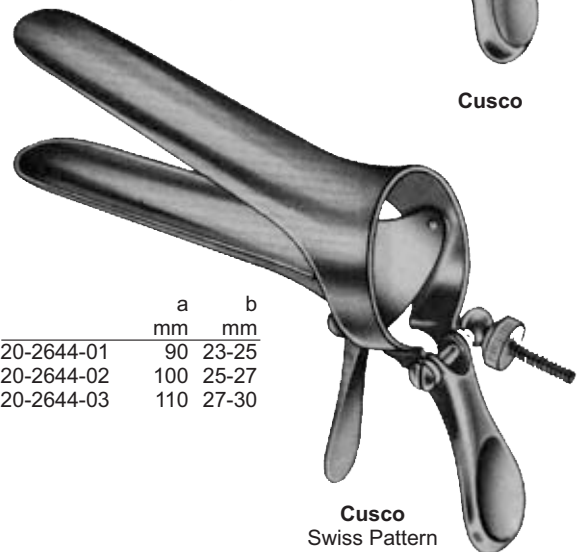

	a mm	b mm
20-2644-01	90	23-25
20-2644-02	100	25-27
20-2644-03	110	27-30

**Cusco
Swiss Pattern**

Gynecology Instruments

Vaginal Speculas
Vaginal Speculas

Speculas vaginales
especulos vaginales

20

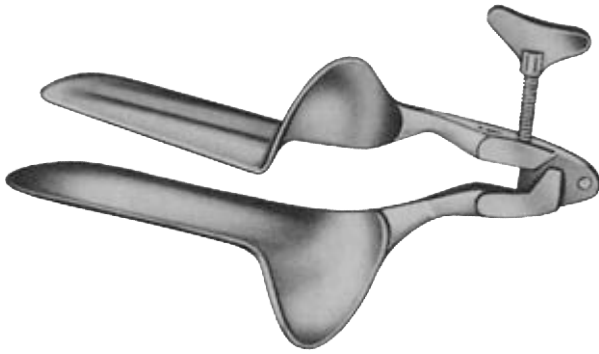

Collin-Landau

	a	b
	mm	mm
20-2645-01	85	30
20-2645-02	100	35
20-2645-03	110	40

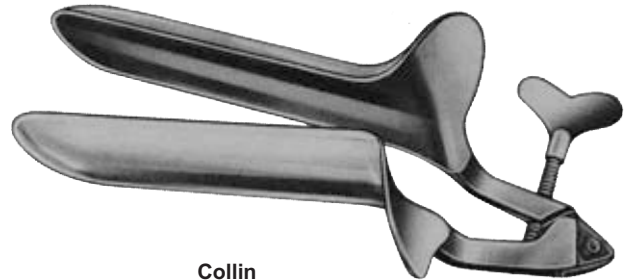

Collin

	a	b
	mm	mm
20-2646-01	85	30
20-2646-02	100	35
20-2646-03	110	40

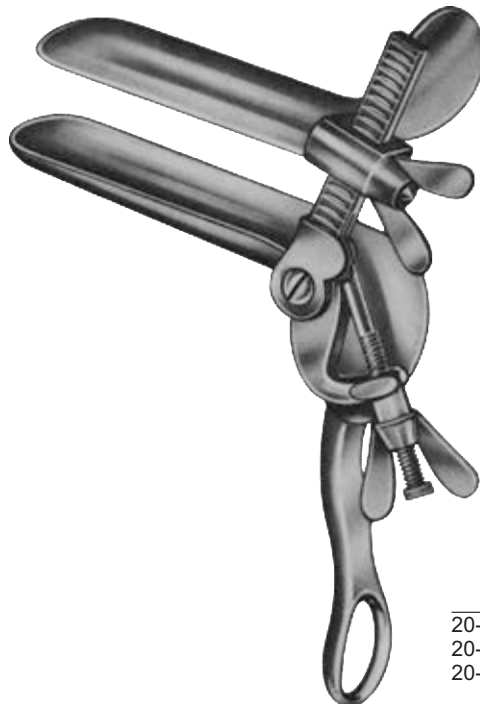

Trelat

	a	b
	mm	mm
20-2647-01	85	33
20-2647-02	95	35
20-2647-03	115	43

Gynecology Instruments

Vaginal Speculas For Laser Surgery
 Vaginal Speculas Für Laser-Chirurgie

Speculas vaginaux pour la chirurgie laser
 Espécules vaginales para la cirugía láser



Grave (Standard)

	a mm	b mm
20-2648-01	75	20
20-2648-02	95	30
20-2648-03	115	35
20-2648-04	125	35

Black



Grave	a mm	b mm
20-2649-01	75	20
20-2649-02	95	30
20-2649-03	115	35

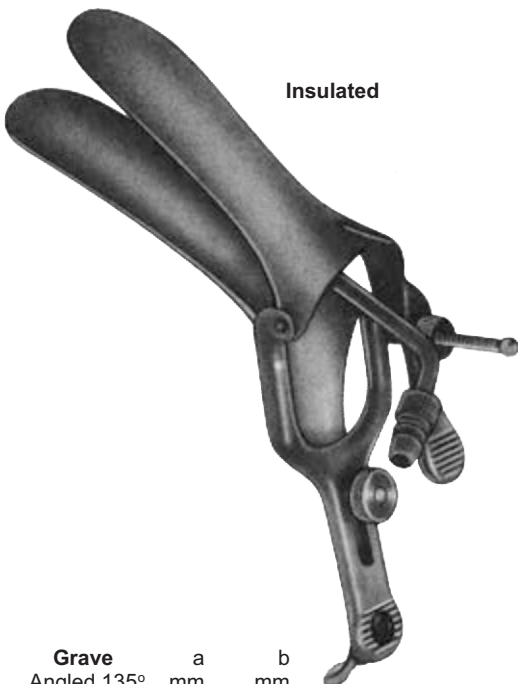

Insulated

Grave	a mm	b mm
Angled 135° 20-2650-00	101	35

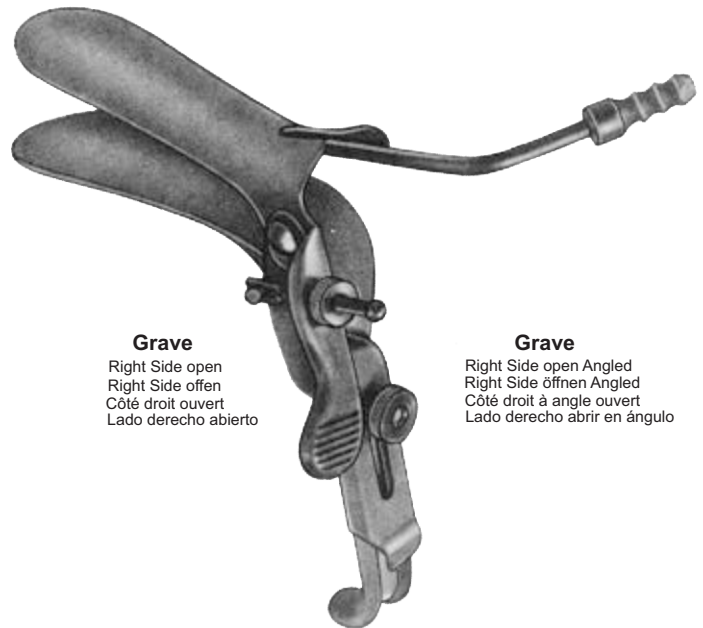

Grave

Right Side open
 Right Side offen
 Côté droit ouvert
 Lado derecho abierto

Grave

Right Side open Angled
 Right Side öffnen Angled
 Côté droit à angle ouvert
 Lado derecho abrir en ángulo

	a mm	b mm
20-2651-01	101	35
20-2651-02	101	35

Gynecology Instruments

Vaginal Speculas
Vaginal Speculas

Speculas vaginales
espéculos vaginales



20

Lateral Specula

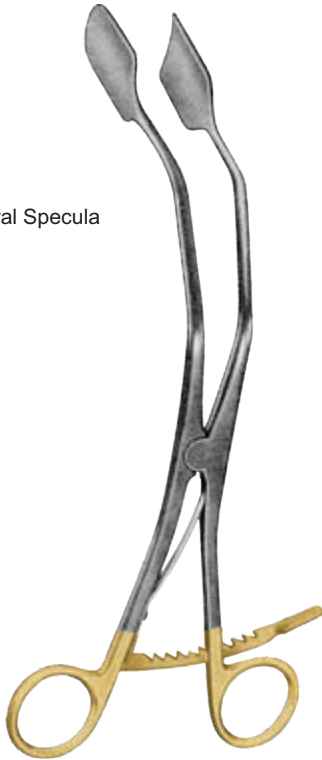

20-2652-00



Pederson	a mm	b mm
20-2653-01	75	13
20-2653-02	100	22
20-2653-03	120	25

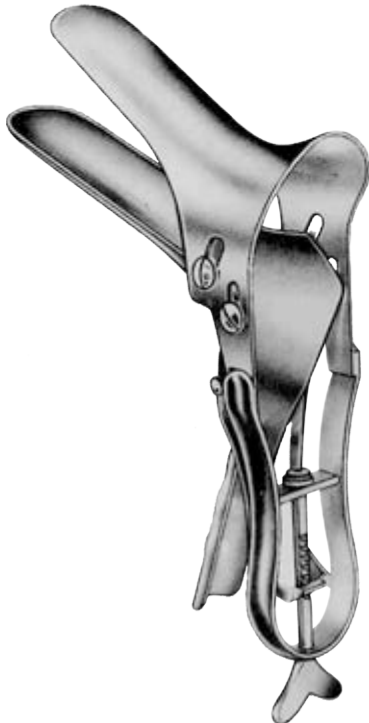

Sayfert	a mm	b mm
20-2654-01	100	17
20-2654-02	1010	33

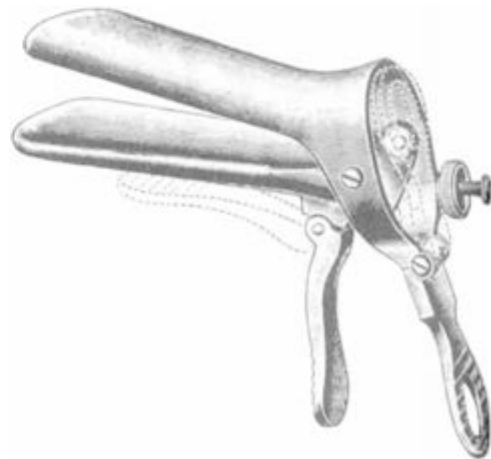

20-2655-01	small, klein, petit, pequeño
20-2655-02	medium, medeum, medeum
20-2655-03	large, groß, grand, grande

Gynecology Instruments

Vaginal Speculas
Vaginal Speculas

Speculas vaginales
espéculos vaginales

Scheme of Dimensions for Specula
Schema Abmessungen für Spekula
Schéma des dimensions de spéculums
Esquema de Medidas para espéculos



a
Length of Blades
ein Länge der Klängen
un Longueur des lames
un Duración de Blades



b
Width of Blades
b Breite der Klängen
b Largeur des lames
b Ancho de Espadas



Sims

20-2656-01	63 x 32 mm
20-2656-02	76 x 32 mm
20-2656-03	89 x 38 mm

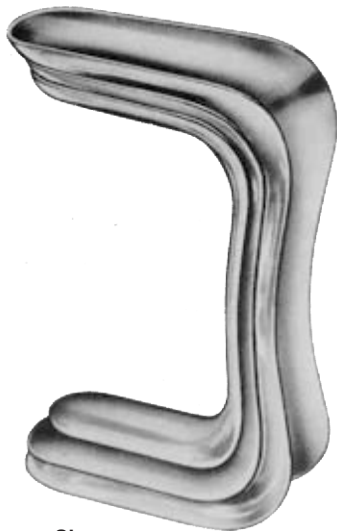

Sims

	Fig	a mm	b mm
20-2657-00			
20-2657-01	1	60	25+30
20-2657-02	2	70	30+35
20-2657-03	3	80	35+40



Jackson

Fig.1	75 x 35	20-2658-01
Fig. 2	90 x 35	20-2658-02
Fig. 3	100 x 35	20-2658-03

	Fig.	a mm	b mm
20-2658-04	4	75 X 40	
20-2658-05	5	90 X 40	
20-2658-06	6	100 X 40	

Gynecology Instruments

Vaginal Speculas
Vaginal Speculas

Speculas vaginales
especulos vaginales



20



Eastman

	Fig.	a mm	b mm
20-2659-01	1	76	38
20-2659-02	2	89	38
20-2659-03	3	101	38



For children
für Kinder
pour les enfants
Para los niños

Set
setzen
fixer
establecer

Kristeller
20-2660-00
70x15 mm



Specula

Retractor

Kristeller
(Standard)

Set of 1 specula and 1 retractor
Set 1 Spekula und 1 Retraktor
Set de 1 spéculums et 1 enrrouleur
1 Juego de especulos y retractor 1

Fig. 1 20-2661-00
Fig. 2 20-2662-00
Fig. 3 20-2663-00

Specula

	Fig.	a mm	b mm
20-2661-01	1	70	27
20-2662-01	2	80	30
20-2663-01	3	90	36

Retractors

	Fig.	a mm	b mm
20-2661-02	1	75	23
20-2662-02	2	85	26
20-2663-02	3	100	32

Gynecology Instruments

Vaginal Speculas
Vaginal Speculas

Speculas vaginales
espéculos vaginales

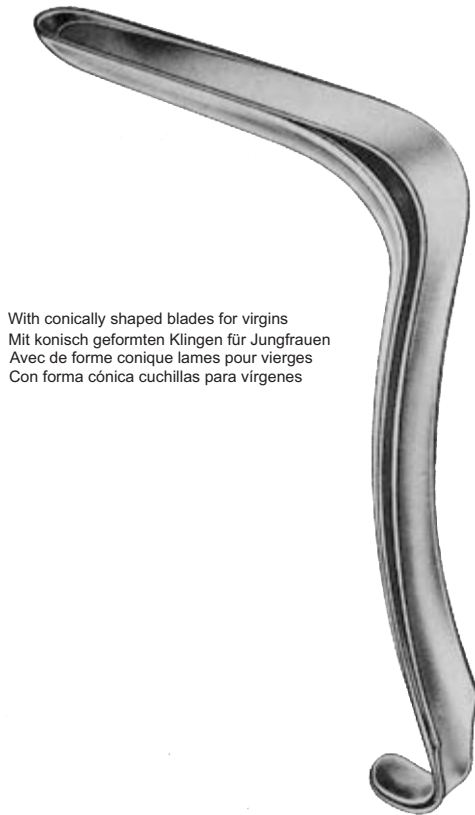

With conically shaped blades for virgins
Mit konisch geformten Klingen für Jungfrauen
Avec de forme conique lames pour vierges
Con forma cónica cuchillas para vírgenes

Kristeller



With extra long blades
Mit extra langen Klingen
Avec de longues lames supplémentaires
Con extra largas hojas

**Kristeller
(Standard)**

Set of 1 specula and 1 retractor
Set 1 Spekula und 1 Retraktor
Set de 1 spéculums et 1 enrouleur
1 Juego de espéculos y retractor 1

Fig. 00 20-2664-00

Fig. 0 20-2665-00

Specula

	Fig.	a		b	
		mm	mm	mm	mm
20-2664-01	00	110	18		
20-2665-01	0	110	21		

Retractors

	Fig.	a		b	
		mm	mm	mm	mm
20-2664-02	00	115	14		
20-2665-02	0	115	17		

Set of 1 specula and 1 retractor
Set 1 Spekula und 1 Retraktor
Set de 1 spéculums et 1 enrouleur
1 Juego de espéculos y retractor 1

Fig. 1 20-2666-00

Fig. 2 20-2667-00

Fig. 3 20-2668-00

Specula

	Fig.	a		b	
		mm	mm	mm	mm
20-2666-01	1	110	27		
20-2667-01	2	110	30		
20-2668-01	3	110	36		

Retractors

	Fig.	a		b	
		mm	mm	mm	mm
20-2666-02	1	115	23		
20-2667-02	2	115	26		
20-2668-02	3	115	32		

Gynecology Instruments

Vaginal Speculas
Vaginal Speculas

Speculas vaginales
especulos vaginales

20



Braun
20-2674-18
18 cm/7"
60x10 mm



Ulrich
20-2675-19
19.5 cm/7 1/2"
80x20 mm



20-2676-19
19 cm/7 1/2"
85x17 mm

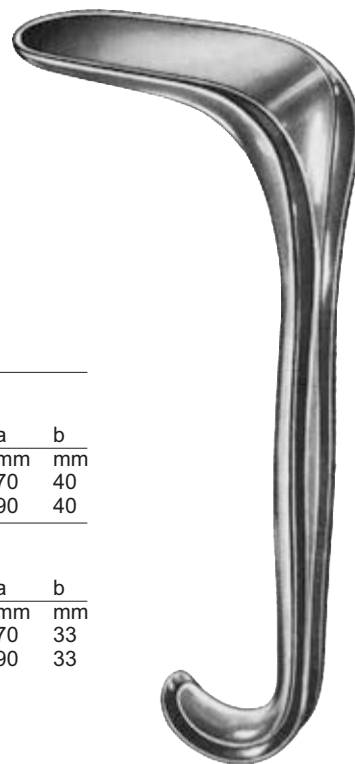

Kallmorgen

Set

20-2677-00 Fig. 1
20-2678-00 Fig. 2

Specula

	Fig.	a b	
		mm	mm
20-2677-01	1	70	40
20-2678-01	2	90	40

Retractors

	Fig.	a b	
		mm	mm
20-2677-02	1	70	33
20-2678-02	2	90	33

Gynecology Instruments

Vaginal Speculas
Vaginal Speculas

Speculas vaginales
espéculos vaginales



With flat hollow specula
Mit flachen Talkessel Spekula
Avec spéculums à plat creux
Con espéculos cuenca llana

Set of 1 specula and 1 retractor
Set 1 Spekula und 1 Retraktor
Set de 1 spéculums et 1 enrrouleur
1 Juego de espéculos y retractor 1

Fig. 1 20-2669-00

Fig. 2 20-2670-00

Fig. 3 20-2671-00

Specula

	Fig.	a	b
		mm	mm
20-2669-01	1	105	26
20-2670-01	2	105	28
20-2671-01	3	105	33

Retractors

	Fig.	a	b
		mm	mm
20-2669-02	1	115	22
20-2670-02	2	115	24
20-2671-02	3	115	29

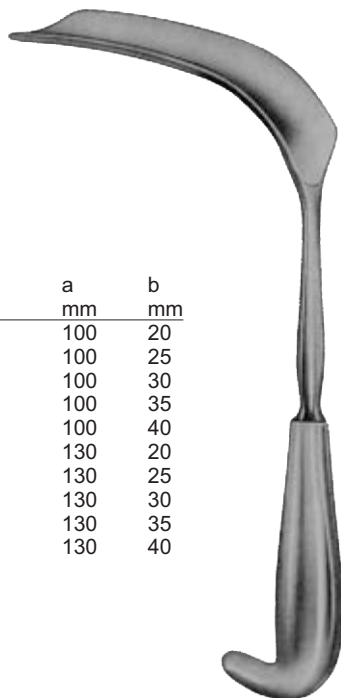

	a	b
	mm	mm
20-2672-20	100	20
20-2672-25	100	25
20-2672-30	100	30
20-2672-35	100	35
20-2672-40	100	40
20-2672-20	130	20
20-2672-25	130	25
20-2672-30	130	30
20-2672-35	130	35
20-2672-40	130	40

Matzenauer



Braun
20-2673-18
18 cm/7"
56x13 mm

Gynecology Instruments

Vaginal Speculas
Vaginal Speculas

Speculas vaginales
especulos vaginales



20

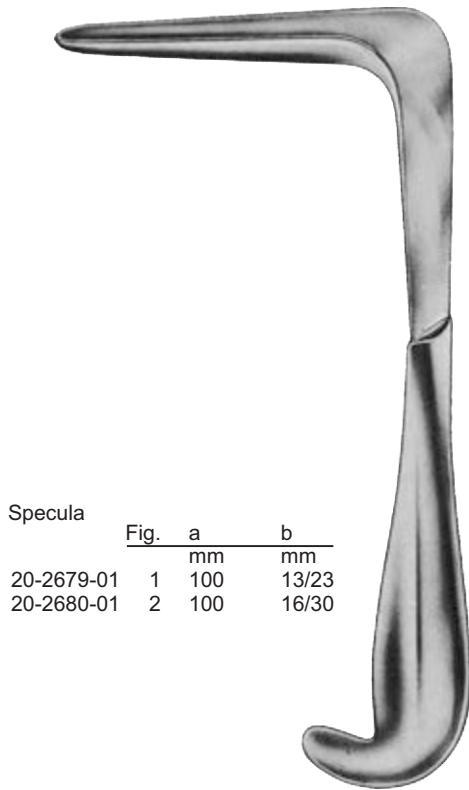

Mathieu

Specula	Fig.	a		b	
		mm	mm	mm	mm
20-2679-01	1	100	13/23		
20-2680-01	2	100	16/30		

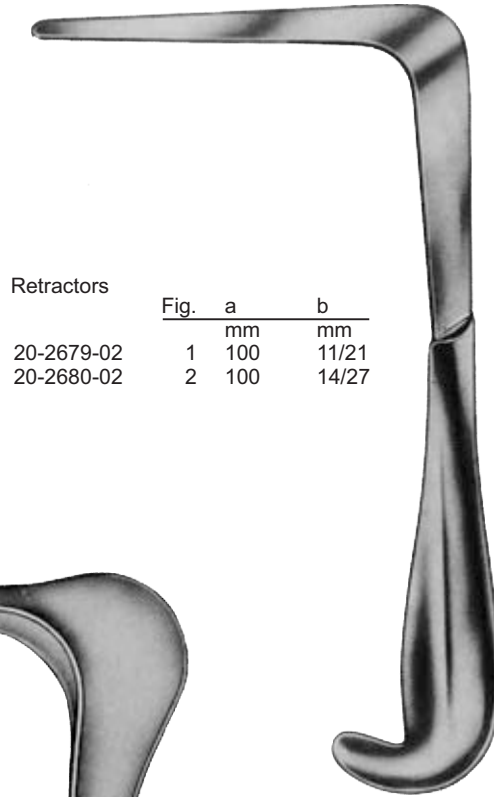

Mathieu

Retractors	Fig.	a		b	
		mm	mm	mm	mm
20-2679-02	1	100	11/21		
20-2680-02	2	100	14/27		

Set	Fig.	a		b	
		mm	mm	mm	mm
	1	20-2681-01			
	2	20-2681-02			

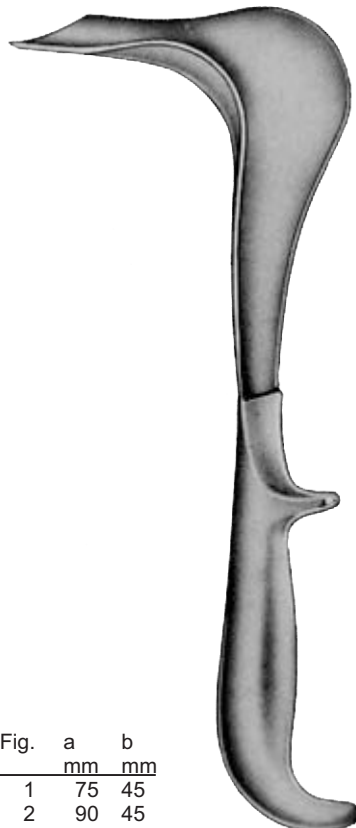

Doyen

	Fig.	a		b	
		mm	mm	mm	mm
20-2682-01	1	75	45		
20-2682-02	2	90	45		
20-2682-03	3	110	45		

Gynecology Instruments

Vaginal Speculas
Vaginal Speculas

Speculas vaginales
espécúlos vaginales



Doyen
24 cm/9 1/2"
slightly-concave
leicht konkav-
légèrement concave
ligeramente cóncava

	Fig.	a mm	b mm
20-2683-01	1	55	35
20-2683-02	2	85	35
20-2683-03	3	115	35
20-2684-01	1	55	45
20-2684-02	2	85	45
20-2684-03	3	115	45
20-2684-04	4	160	45
20-2684-05	5	180	45
20-2685-01	1	55	60
20-2685-02	2	85	60
20-2685-03	3	115	60
20-2685-04	4	160	60
20-2685-05	5	180	60

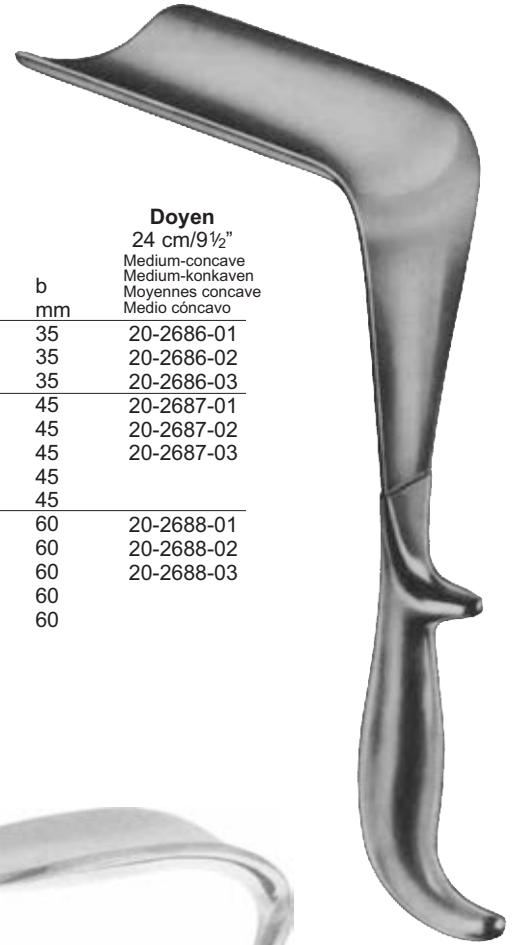

Doyen
24 cm/9 1/2"
Medium-concave
Medium-konkaven
Moyennes concave
Medio cóncavo

20-2686-01
20-2686-02
20-2686-03
20-2687-01
20-2687-02
20-2687-03
20-2688-01
20-2688-02
20-2688-03



Doyen
25 cm/10"

	a mm	b mm
20-2689-01	60	30
20-2689-02	70	30
20-2689-03	80	30



Mangiagalli
20-2690-00
40 x 80 mm

Gynecology Instruments

Vaginal Speculas
Vaginal Speculas

Speculas vaginales
especulos vaginales



20



Auvard

with removable weight
mit abnehmbarem Gewicht
avec un poids amovible
con peso extraible

20-2691-01
80x38mm
20-2691-02
105x42mm

Auvard

with fixed weight
mit festem Gewicht
avec un poids fixe
con peso fijo

20-2692-01
80x38 mm
20-2692-02
105x42 mm



Landau
29 cm/11½"

	a	b
	mm	mm
20-2693-01	100	28
20-2693-02	100	38



Breisky

	a	b
	mm	mm
20-2694-20	100	20
20-2694-25	100	25
20-2694-30	100	30
20-2694-35	100	35
20-2694-40	100	40
20-2695-20	130	20
20-2695-25	130	25
20-2695-30	130	30
20-2695-35	130	35
20-2695-40	130	40
20-2696-20	160	20
20-2696-25	160	25
20-2696-30	160	30
20-2696-35	160	35
20-2696-40	160	40
20-2697-20	180	20
20-2697-25	180	25
20-2697-30	180	30
20-2697-35	180	35
20-2697-40	180	40

Gynecology Instruments

Vaginal Speculas and Retractors
Vaginal Speculas und Retraktoren

Speculas vaginaux et rétracteurs
Especulos vaginales y retractoros



Bozemann
20-2698-00

Complete



20-2698-05
80 x 30 mm



20-2698-01
65 x 30 mm



20-2698-06
85 x 33 mm



20-2698-02
75 x 35 mm



20-2698-07
100 x 38 mm



20-2698-03
85 x 35 mm



20-2698-08
110 x 42 mm



20-2698-04
95 x 35 mm

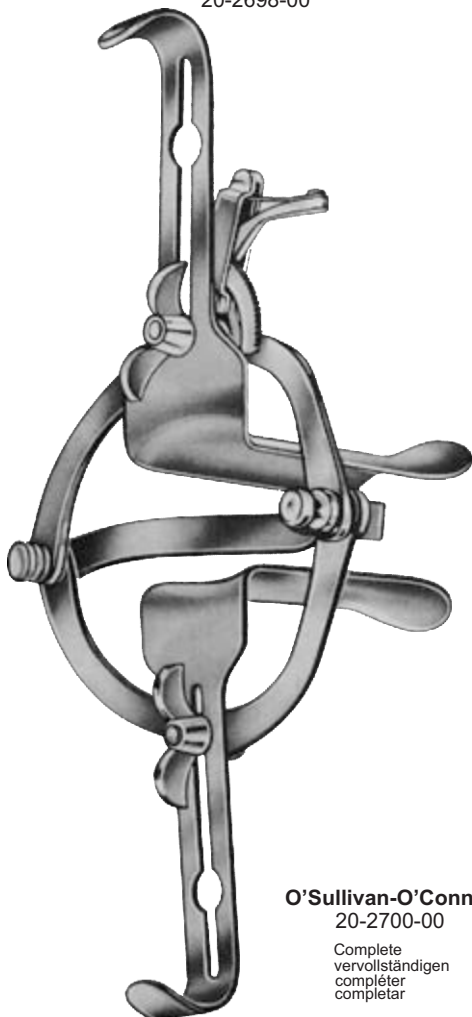

O'Sullivan-O'Connor
20-2700-00

Complete
vervollständigen
compléter
completar

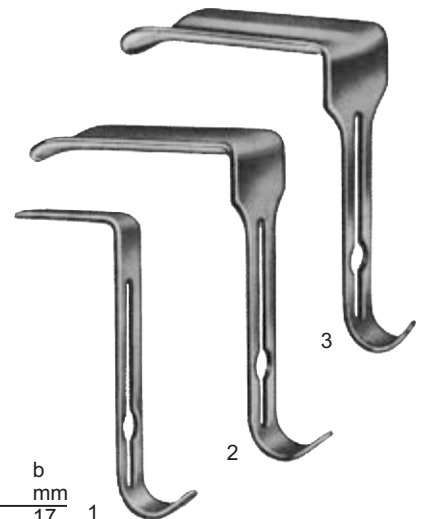

	Fig.	a mm	b mm
20-2699-01	1	45	17
20-2699-02	2	90	37
20-2699-03	3	90	45

Gynecology Instruments

Uterine Dilators
Uterus-Dilatatoren

Dilatateurs utérins
dilatadores uterinos



20



Hegar

mmØ		mmØ	
1.0	20-2701-01	1.5	20-2702-01
2.0	20-2701-02	2.5	20-2702-02
3.0	20-2701-03	3.5	20-2702-03
4.0	20-2701-04	4.5	20-2702-04
5.0	20-2701-05	5.5	20-2702-05
6.0	20-2701-06	6.5	20-2702-06
7.0	20-2701-07	7.5	20-2702-07
8.0	20-2701-08	8.5	20-2702-08
9.0	20-2701-09	9.5	20-2702-09
10.0	20-2701-10	10.5	20-2702-10
11.0	20-2701-11	11.5	20-2702-11
12.0	20-2701-12	12.5	20-2702-12
13.0	20-2701-13	13.5	20-2702-13
14.0	20-2701-14	14.5	20-2702-14
15.0	20-2701-15	15.5	20-2702-15
16.0	20-2701-16	16.5	20-2702-16
17.0	20-2701-17	17.5	20-2702-17
18.0	20-2701-18	18.5	20-2702-18
19.0	20-2701-19	19.5	20-2702-19
20.0	20-2701-20		
21.0	20-2701-21		
22.0	20-2701-22		
23.0	20-2701-23		
24.0	20-2701-24		
25.0	20-2701-25		
26.0	20-2701-26		
27.0	20-2701-27		
28.0	20-2701-28		
29.0	20-2701-29		
30.0	20-2701-30		

Pieces per set		set	
20-2701-40	14	4.0-17.0 mm	In canvas
20-2701-50	14	4.0-17.0 mm	In metal case
20-2701-60	26	1.0-26.0 mm	in canvas
20-2701-70	26	1.0-26.0 mm	in metal case



Hegar

Ø mm	
1.0/2.0	20-2703-02
3.0/4.0	20-2703-04
5.0/6.0	20-2703-06
7.0/8.0	20-2703-08
9.0/10.0	20-2703-10
11.0/12.0	20-2703-12
13.0/14.0	20-2703-14
15.0/16.0	20-2703-16
17.0/18.0	20-2703-18
19.0/20.0	20-2703-20
21.0/22.0	20-2703-22
23.0/24.0	20-2703-24
25.0/26.0	20-2703-26

Pieces per set		set	
20-2703-40	08	3.0/4.0-17.0/18.0 mm	
20-2704-60	13	1.0/2.0-25.0/26.0 mm	
20-2703-50	08	3.0/4.0-17.0/18.0 mm	
20-2704-70	13	1.0/2.0-25.0/26.0 mm	

Gynecology Instruments

Uterine Dilators
Uterus-Dilatatoren

Dilatateurs utérins
dilatadores uterinos



Pratt

Fig.	mm	
13/15	4.5/5.0	20-2705-15
17/19	5.6/6.3	20-2705-19
21/23	7.0/7.6	20-2705-23
25/27	8.3/9.0	20-2705-27
29/31	9.6/10.3	20-2705-31
33/35	11.0/11.6	20-2705-35
37/39	12.3/13.0	20-2705-39
41/43	13.6/14.3	20-2705-43

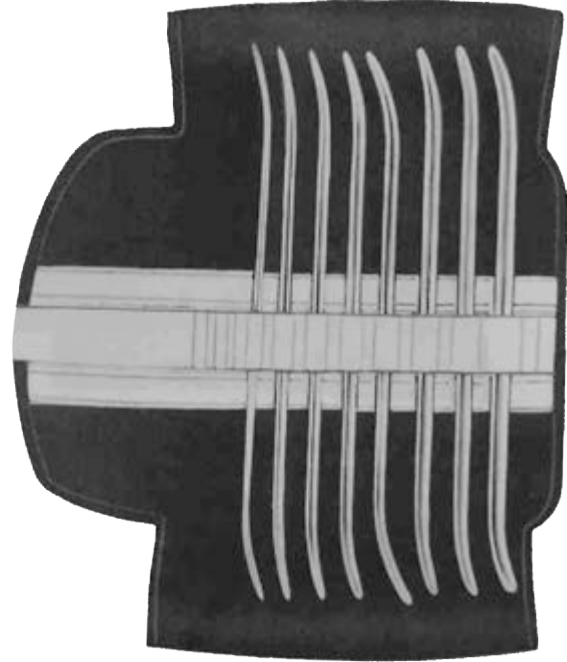

Set
20-2705-00



Hank
20-2706-00

Fig.	mm	
9/10	4.5/5	20-2706-10
11/12	5.5/6	20-2706-12
13/14	6.5/7	20-2706-14
15/16	7.5/8	20-2706-16
17/18	8.5/9	20-2706-18
19/20	9.5/10	20-2706-20

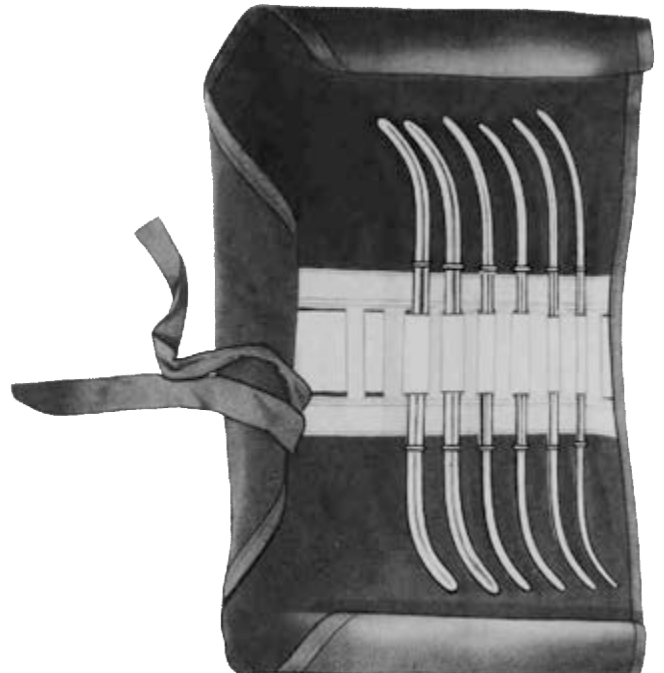

Set

Gynecology Instruments

Uterine Tenaculum Forceps, Amniotome
Uterine Hakchen Pinzette, Amniotome

Tenaculum uterine Forceps, amniotomie
Uterina tenaculo pinzas, Amniotome

20



Sims
20-2707-33
33 cm/13"



Sims
20-2708-33
33 cm/13"



Walleix
20-2709-29
29.5 cm/11 1/2"



Braun
20-2710-27
27.5 cm/11 3/4"

Gynecology Instruments

Uterine Sounds, Uterine Depressor
Uterus-Sounds, Uterus-Depressor

Sons utérins, de l'utérus dépresseurs
Los sonidos uterinos, útero depresores



Schroder
20-2711-25
25.5 cm/10 "

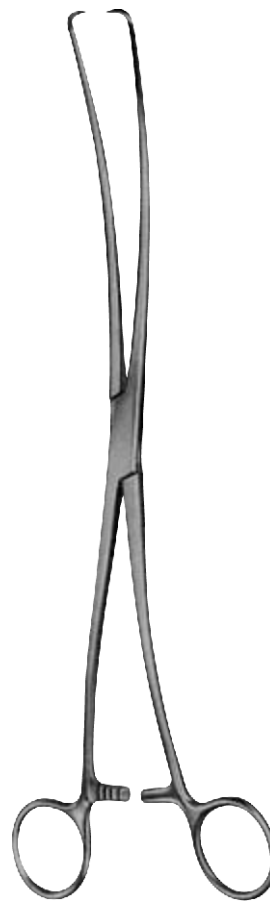

Duply
20-2712-25
25.5 cm/10 "

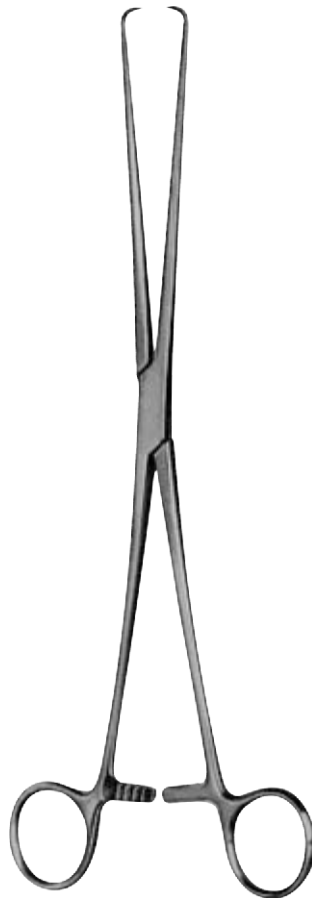

¹/₄
Braun
20-2713-25
25 cm/10 "



Beacham
20-2714-26
26 cm/10 ¹/₄"

Gynecology Instruments

Uterine Tenaculum Forceps
Uterine Tenakulum Zange

Utérine Forceps tenaculum
Pinza uterina tenáculo



20

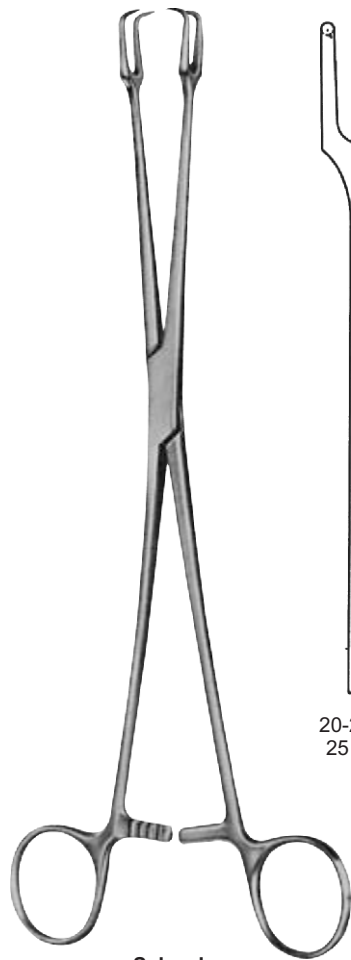

Schroder

20-2715-25
25 cm/9 ³/₄"

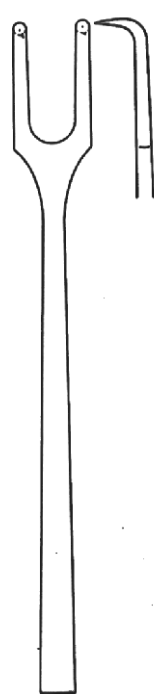

20-2716-23
23.5 cm/9 ¹/₄"



Skene
20-2717-24
24 cm/9 ¹/₂"



Teale
20-2718-23
23.5 cm/9 ¹/₄"

Gynecology Instruments

Uterine Tenaculum Forceps
Uterine Tenakulum Zange

Utérine Forceps tenaculum
Pinza uterina tenáculo



20-2719-26
26 cm/10 1/4"

IOWA

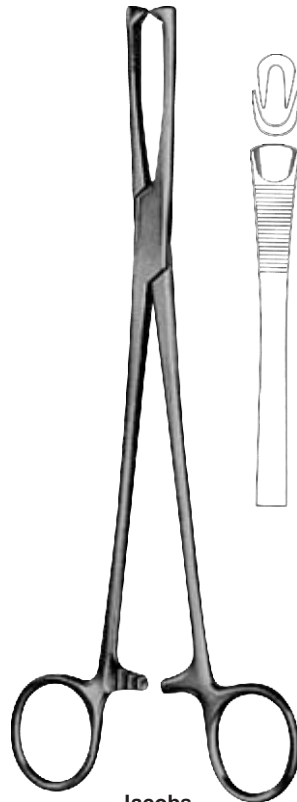

20-2723-21
21 cm/8 1/4"

JACOBS

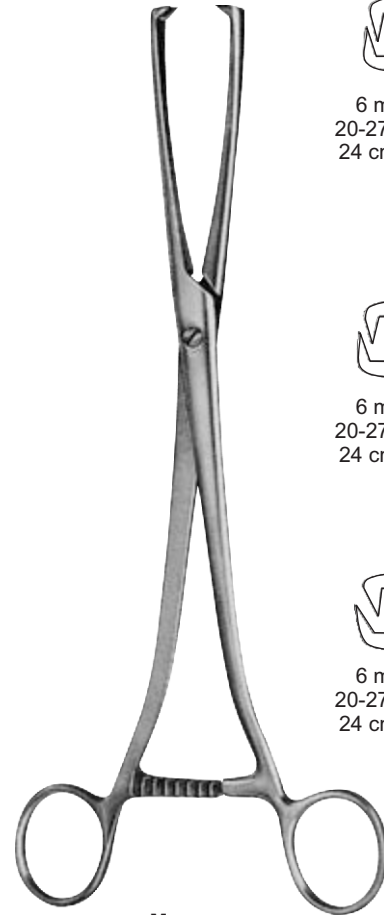

6 mm
20-2720-24
24 cm/9 1/2"

6 mm
20-2721-24
24 cm/9 1/2"

6 mm
20-2722-24
24 cm/9 1/2"

MUSEUX

Gynecology Instruments

Uterine Tenaculum Forceps
Uterine Tenakulum Zange

Utérine Forceps tenaculum
Pinza uterina tenáculo

20

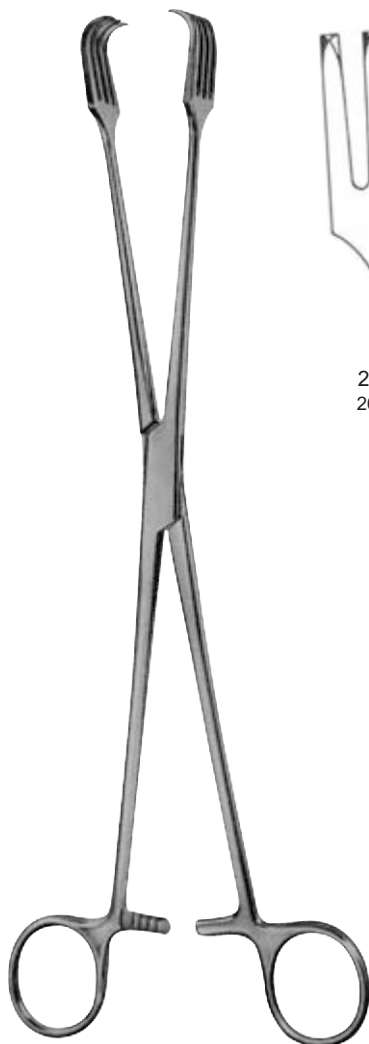

20-2724-26
26.5 cm/10 1/2"

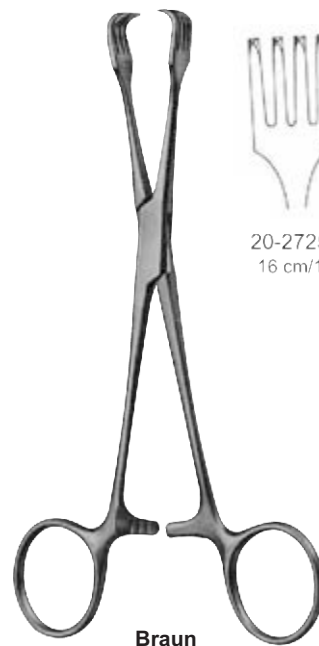

20-2725-16
16 cm/10 1/4"

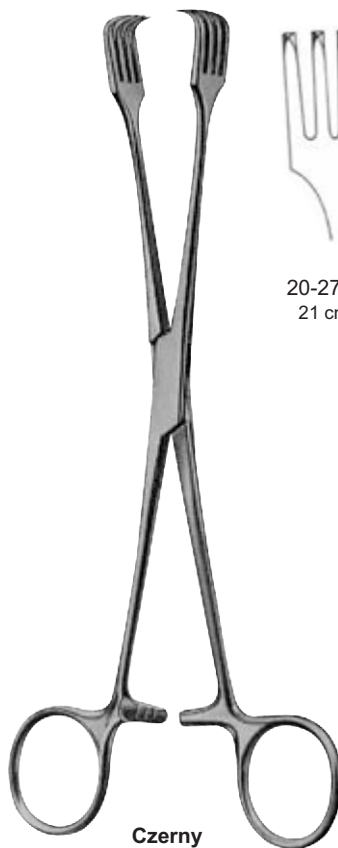

20-2726-21
21 cm/8 1/4"



Gynecology Instruments

Uterine Pulypus Forceps
Uterine Pulypus Zange

Utérine Pulypus Forceps
Pinza uterina Pulypus



20-2727-32
32 cm/12½"

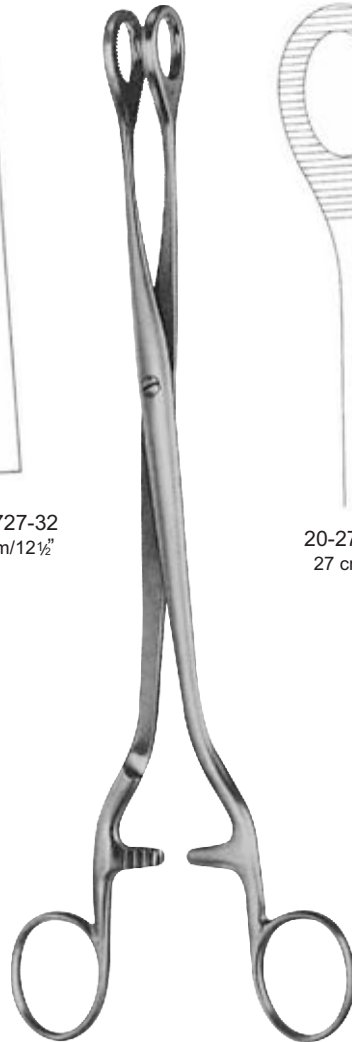

20-2728-27
27 cm/10¼"



20-2729-25
25 cm/9¾"



Gynecology Instruments

Uterine Seizing Forceps
Uterine ergriff Zange

Utérins Forceps Saisir
Uterinos Pinzas Aprovechar

20



Dartigues
20-2733-25
28 cm/11"

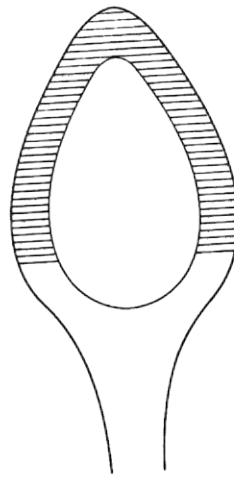
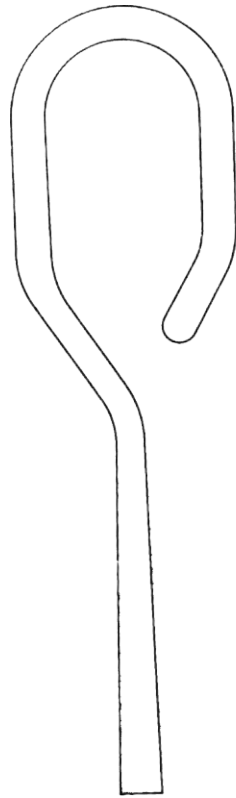

Somer
20-2734-25
22.5 cm/8 3/4"

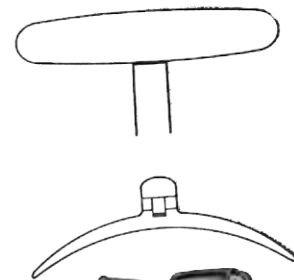

Collin
20-2735-26
26 cm/10 1/4"

Gynecology Instruments

Myoma Screws, Myoma Knife
Schrauben Myom, Myome Knife

Vis myome, couteaux myomes
Tornillos, mioma Mioma Knife



Doyen
20-2730-17
17 cm/6 3/4"



Doyen
20-2731-14
14.5 cm/5 3/4"



20-2732-28
28 cm/11"

Segand

3/4

Gynecology Instruments

Suction Curettes, Uterine Biopsy Curettes
Saug-Küretten, Uterus-Biopsie Küretten

Curettes d'aspiration, de l'utérus biopsie Curettes
Curetas de aspiración, biopsia uterina Curetas



20

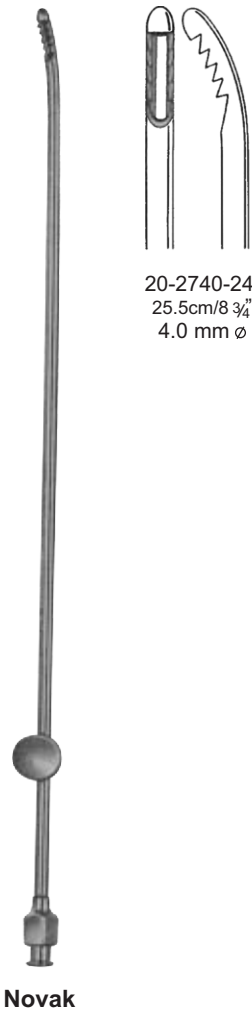

Gynecology Instruments

Fistula Hooks
Fistula Haken

Crochets fistule
Ganchos fistula

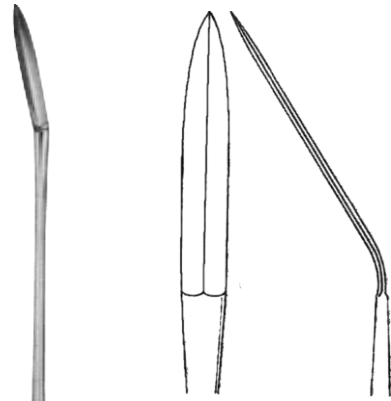

20-2736-23
23.5 cm/9 1/4"

Ayre



20-2737-23
22 cm/9 3/4"

Emmett



Simon

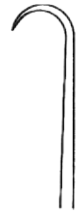

20-2738-21
21.5cm/8 1/2"



Simon

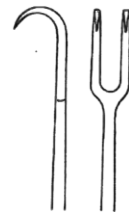

20-2739-21
21.5cm/8 1/2"

Gynecology Instruments

Uterine Biopsy Forceps
Uterine Biopsiezangen

Pince à biopsie utérine
Pinzas de biopsia uterina



20

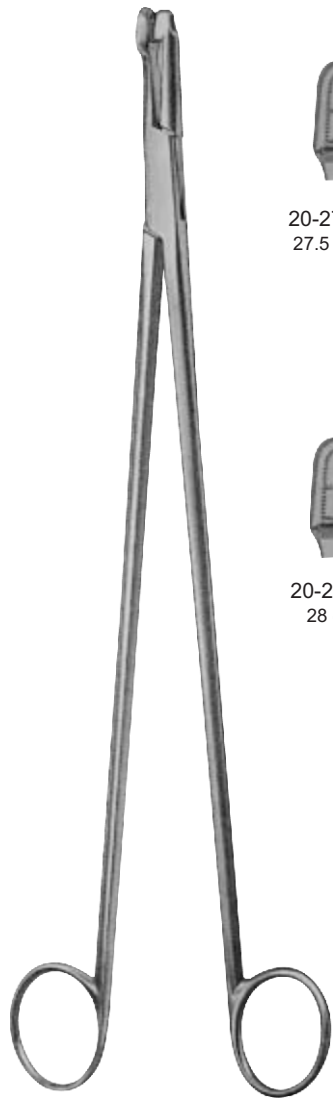

Schubert



20-2743-21
27.5 cm/8 1/2"

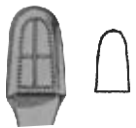

20-2743-28
28 cm/11"



20-2744-21
21 cm/8 1/4"



Faure



20-2745-24
24 cm/8 1/2"



Gellhorn

Gynecology Instruments

Uterine Biopsy Forceps
Uterine Biopsiezangen

Pince à biopsie utérine
Pinzas de biopsia uterina



20-2746-21
21 cm/8 $\frac{1}{4}$ "



20-2746-23
23.5 cm/9 $\frac{1}{4}$ "



Thoms-Gaylor

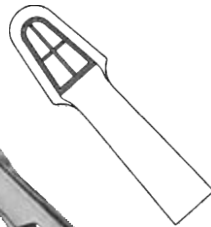

20-2747-25
25.5 cm/10"

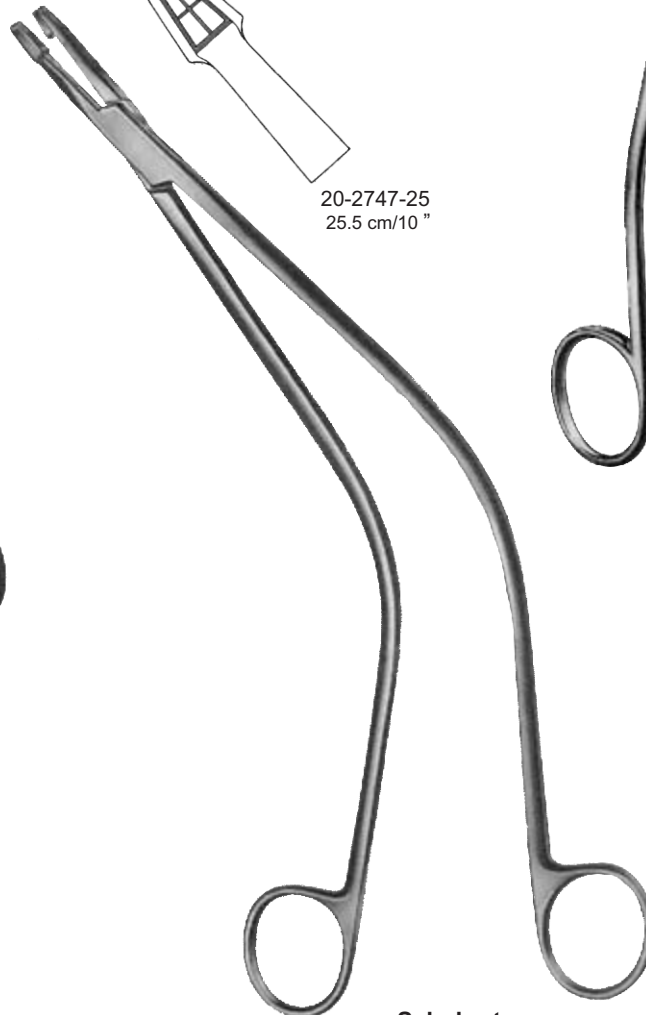

Schubert



20-2748-27
27cm/10 $\frac{3}{4}$ "



Van Doren

Gynecology Instruments

Uterine Biopsy Forceps
Uterine Biopsiezangen

Pince à biopsie utérine
Pinzas de biopsia uterina

20

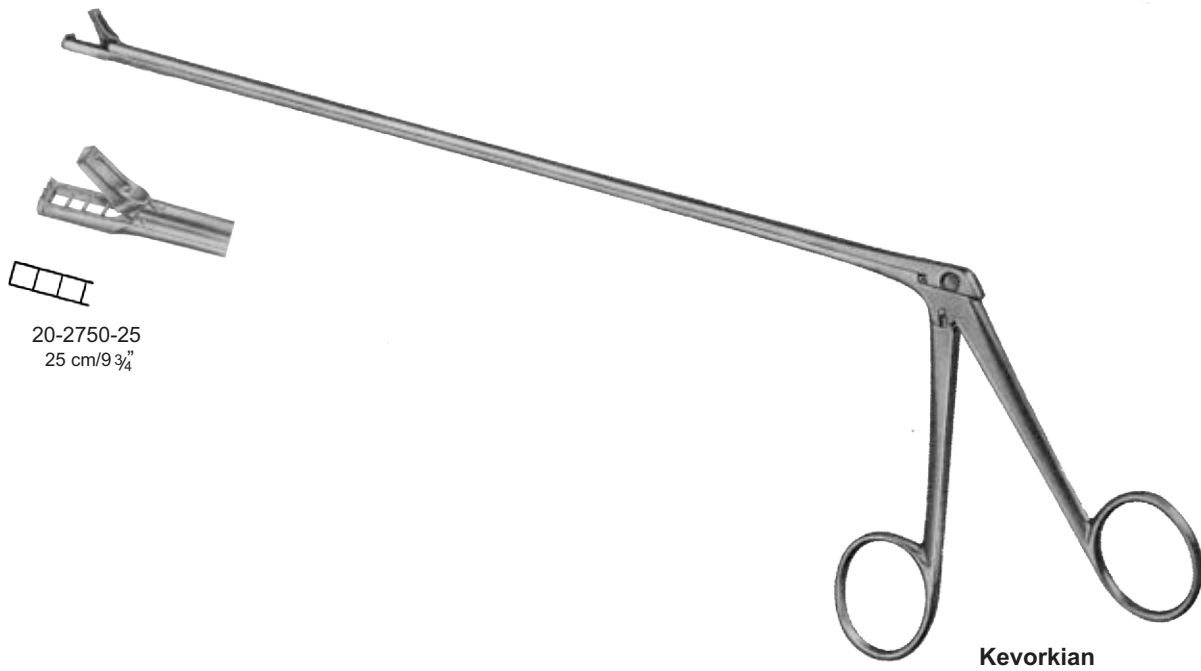
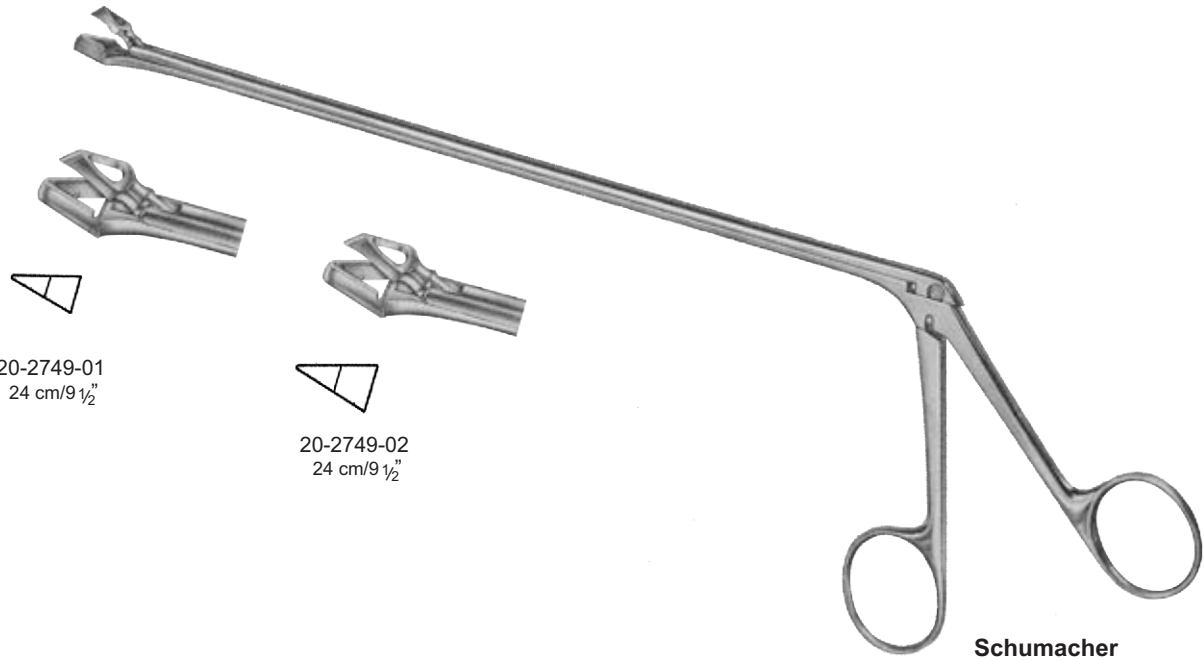

Gynecology Instruments

Uterine Biopsy Forceps
Uterine Biopsiezangen

Pince à biopsie utérine
Pinzas de biopsia uterina



20-2751-25
25.5 cm/10"

Van Doren



20-2752-28
28 cm/11"

Alexander

Gynecology Instruments

Uterine Biopsy Forceps, IUP Grasping Forceps
Uterine Biopsiezangen, IUP Faßzange

Utérine pinces à biopsie, pinces à préhension IUP
Uterina pinzas de biopsia, Pinzas IUP Agarre



20

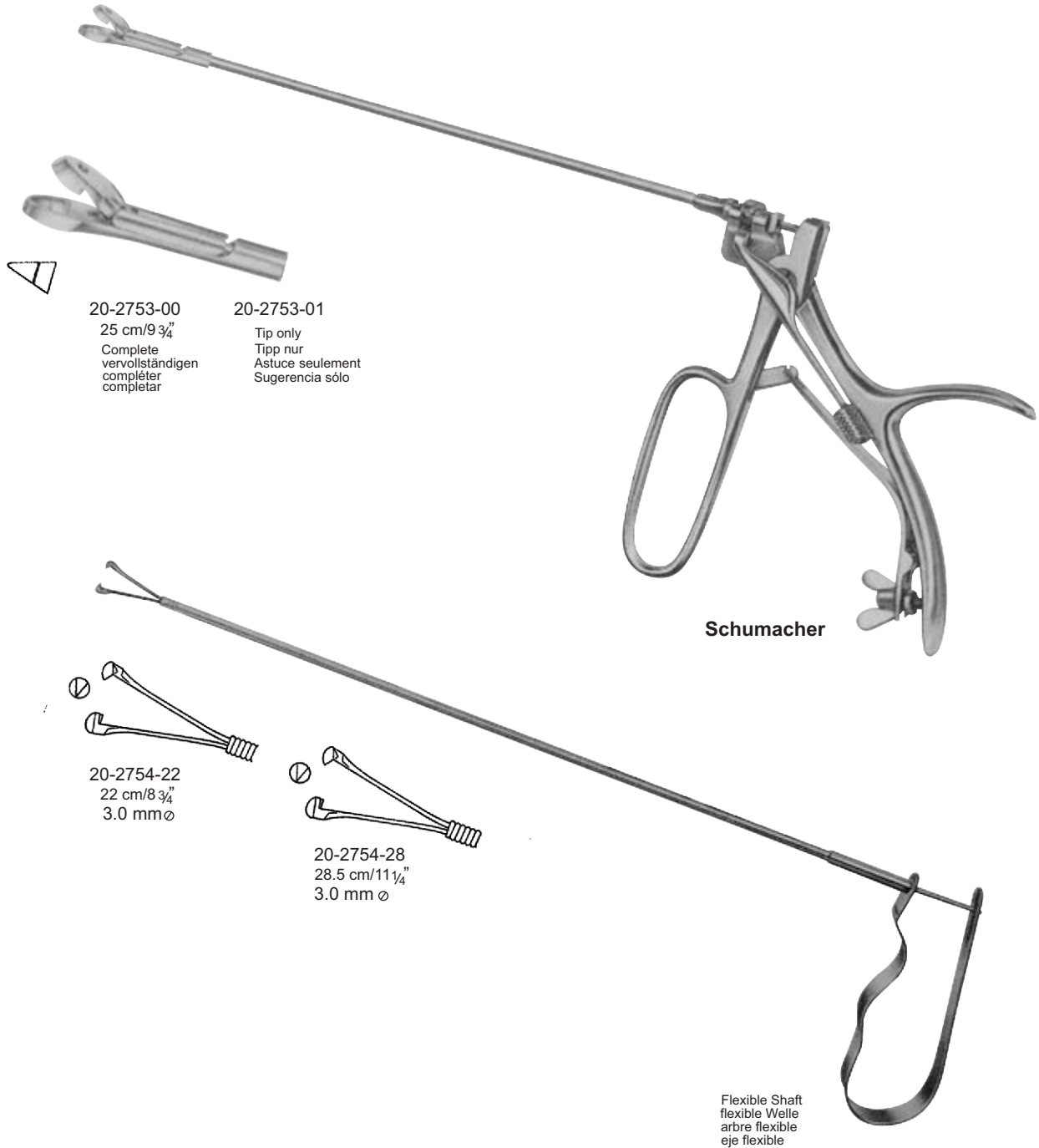

Gynecology Instruments

Uterine Scoops
Uterine Scoops

utérine Scoops
uterina Scoops



9,8 x 6,8 mm
20-2755-01
24,5 cm/9 3/4"



9,8 x 6,8 mm
20-2756-01
30 cm/11 3/4"



11,6 x 8,3 mm
20-2755-02
24,5 cm/9 3/4"



11,6 x 8,3 mm
20-2756-02
30 cm/11 3/4"

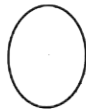

13,2 x 10,0 mm
20-2755-03
24,5 cm/9 3/4"



13,2 x 10,0 mm
20-2756-03
31 cm/12 1/4"



16,0 x 11,6 mm
20-2755-04
24,5 cm/9 3/4"



16,0 x 11,6 mm
20-2756-04
31 cm/12 1/4"



18,0 x 12,6 mm
20-2755-05
25 cm/9 3/4"



18,0 x 12,6 mm
20-2756-05
31 cm/12 1/4"

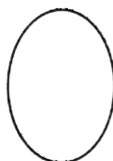

20,0 x 13,8 mm
20-2755-06
25 cm/9 3/4"



20,0 x 13,8 mm
20-2756-06
31 cm/12 1/4"



Simon



Simon

Gynecology Instruments

Uterine Curettes Curettes utérines
 Uterus-Küretten Curetas uterinas



20



Recamier
 20-2757-05
 20-2757-40



Recamier
 20-2758-05
 20-2758-40



Sims
 20-2759-05
 20-2759-40



Sims
 20-2760-05
 20-2760-40

Fig	mm	20-2757-05	20-2758-05	20-2759-05	20-2760-05
00	5	20-2757-05	20-2758-05	20-2759-05	20-2760-05
0	6	20-2757-06	20-2758-06	20-2759-06	20-2760-06
1	7	20-2757-07	20-2758-07	20-2759-07	20-2760-07
2	8	20-2757-08	20-2758-08	20-2759-08	20-2760-08
3	9	20-2757-09	20-2758-09	20-2759-09	20-2760-09
4	10	20-2757-10	20-2758-10	20-2759-10	20-2760-10
5	12	20-2757-12	20-2758-12	20-2759-12	20-2760-12
6	14	20-2757-14	20-2758-14	20-2759-14	20-2760-14
7	15	20-2757-15	20-2758-15	20-2759-15	20-2760-15
8	16	20-2757-16	20-2758-16	20-2759-16	20-2760-16
9	19	20-2757-19	20-2758-19	20-2759-19	20-2760-19
10	20	20-2757-20	20-2758-20	20-2759-20	20-2760-20
11	21	20-2757-21	20-2758-21	20-2759-21	20-2760-21
12	23	20-2757-23	20-2758-23	20-2759-23	20-2760-23
13	25	20-2757-25	20-2758-25	20-2759-25	20-2760-25
14	30	20-2757-30	20-2758-30	20-2759-30	20-2760-30
15	35	20-2757-35	20-2758-35	20-2759-35	20-2760-35
16	40	20-2757-40	20-2758-40	20-2759-40	20-2760-40

Gynecology Instruments

Uterine Curettes
Uterus-Küretten

Curettes utérines
Curetas uterinas



Fig. 00
5 mm
31 cm/12 1/4"
20-2761-05



Fig. 0
6 mm
31 cm/12 1/4"
20-2761-06



Fig. 1
7 mm
31 cm/12 1/4"
20-2761-07



Fig. 2
8 mm
31 cm/12 1/4"
20-2761-08



Fig. 3
9 mm
31 cm/12 1/4"
20-2761-09



Fig. 4
11 mm
31 cm/12 1/4"
20-2761-11



Fig. 5
12 mm
31 cm/12 1/4"
20-2761-12



Fig. 6
14 mm
31 cm/12 1/4"
20-2761-14



Fig. 7
15 mm
31 cm/12 1/4"
20-2761-15



Fig. 8
16 mm
31 cm/12 1/4"
20-2761-16



Fig. 9
19 mm
31 cm/12 1/4"
20-2761-19



Fig. 10
20 mm
31 cm/12 1/4"
20-2761-20



Fig. 11
21 mm
31 cm/12 1/4"
20-2761-21



Fig. 12
23 mm
31 cm/12 1/4"
20-2761-23



Fig. 13
25 mm
34 cm/13 1/2"
20-2761-25



Fig. 14
30 mm
35 cm/12 3/4"
20-2761-30



Fig. 15
35 mm
35 cm/12 3/4"
20-2761-35



Fig. 16
40 mm
35 cm/12 3/4"
20-2761-40

Ophthalmology Instruments

Eye Speculas
Eye Speculas

Speculas Eye
espéculos de ojos

21



Weiss
21-2762-07
7 cm/2¾"
Children
Kinder
enfants
niños

21-2763-09
9 cm/3½"
Adults
Erwachsene
Adultes
Adultos



Weiss
21-2764-07
7 cm/2¾"
Children
Kinder
enfants
niños

21-2765-09
9 cm/3½"
Adults
Erwachsene
Adultes
Adultos



Park-Guyton
21-2766-08
8 cm/3¼"

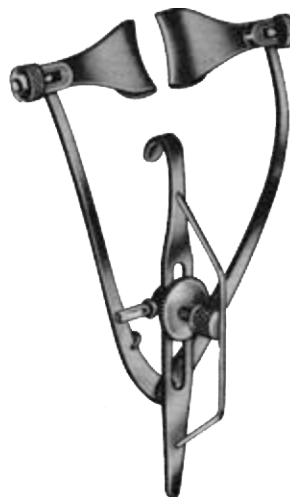

Park-Maumenee
21-2767-08
8 cm/3¼"

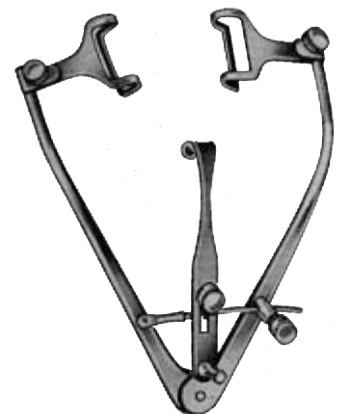

Park
21-2768-08
8 cm/3¼"

Ophthalmology Instruments

Eye Speculas
Eye Speculas

Speculas Eye
especulos de ojos



Children **Barraquer (Colibri)** Adults
21-2769-03 21-2769-04
3 cm/1¼" 4 cm/1½"

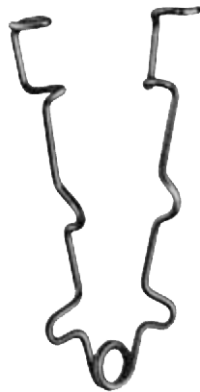

Bowman
21-2770-07
7 cm/2¾"



Sauer
21-2771-03
3 cm/1¼"



Goldstein
21-2772-03
3 cm/1¼"

For left eye
Für das linke Auge
Pour l'œil gauche
Para el ojo izquierdo

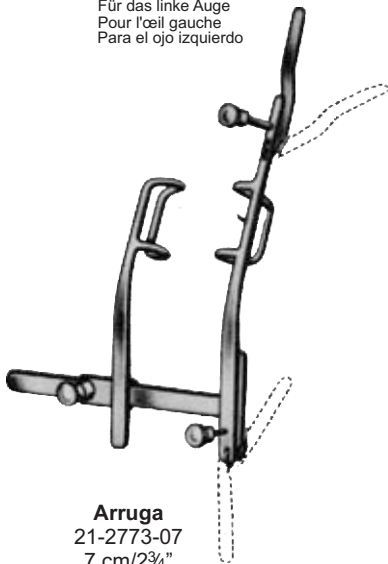

Arruga
21-2773-07
7 cm/2¾"

For right eye
Für das rechte Auge
Pour l'œil droit
Para el ojo derecho

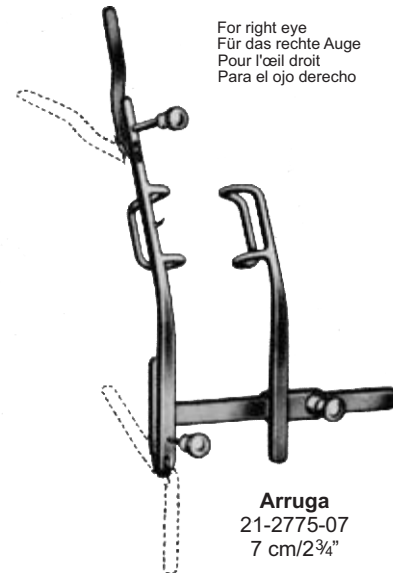

Arruga
21-2775-07
7 cm/2¾"



Mellinger-Axenfeld
21-2774-07
7 cm/2¾"

Ophthalmology Instruments

Eye Speculas
Eye Speculas

Speculas Eye
espejos de ojos



21



Mellinger-Axenfeld
21-2776-07
7 cm/2¾"



Mellinger
21-2777-05
5 cm/2"
Children
Kinder
enfants
niños

21-2777-07
7 cm/2¾"
Adults
Erwachsene
Adultes
Adultos



Mellinger Beard
21-2778-05
5 cm/2"
Children
Kinder
enfants
niños

21-2778-07
7 cm/2¾"
Adults
Erwachsene
Adultes
Adultos



Knapp Clark
21-2779-08
8 cm/3¼"



Graefe
21-2780-06
6 cm/2½"
Children
Kinder
enfants
niños

21-2780-09
9 cm/3½"
Adults
Erwachsene
Adultes
Adultos



Cook
21-2781-04
4 cm/1½"
Children
Kinder
enfants
niños

21-2781-05
5 cm/2"
Adults
Erwachsene
Adultes
Adultos



Lancaster
21-2782-08
8 cm/3¼"



Williams
Children
21-2783-07
7 cm/2¾"
Children
Kinder
enfants
niños

Adults
21-2783-08
8 cm/3¼"
Adults
Erwachsene
Adultes
Adultos



Lister-Burch
21-2784-08
8 cm/3¼"

Ophthalmology Instruments

Eye Speculas
Eye Speculas

Speculas Eye
especulos de ojos



Weiss
21-2785-08
8 cm/3¼"



Murdock
21-2786-05
5 cm/2"

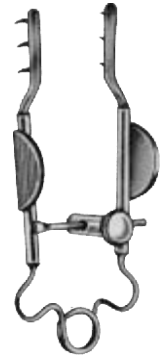

Mueller
21-2787-07
7 cm/2¾"



Critchett
21-2788-06
6 cm/2½"



Castroviejo
21-2789-08
8 cm/3¼"



Stevenson
21-2790-07
7 cm/2¾"



Agricola
21-2791-04
4 cm/1½"

Ophthalmology Instruments

Eye Lasek
Eye Lasek

Eye Lasek
ojo de Lasek

21



Flap Repositor
21-2792-60



Micro-Hoe and Epi-Peeler
21-2793-62



Trepine 8 mm
Alcohol wcl 9.5 mm
21-2794-64

Ophthalmology Instruments

Eye Instruments
Eye Instruments

Instruments Eye
Instrumentos de ojos

Also Available in Titanium
Auch in Titan
Aussi disponible en titane
También Disponible en Titanio



Lewicky
21-2795-66
Lens Manipulator



Kuglen
21-2796-68/S
21-2796-68/A
Iris Hook & lens
Manipulator Push
Pull model



Bechert
21-2797-01 7mm
21-2797-02 9 mm



Lesten
21-2798-0S
21-2798-0A



Kuglen
21-2799-0S
21-2799-0A



Sinskey
21-2800-0S
21-2800-0A

Ophthalmology Instruments

Eye Instruments
Eye Instruments

Instruments Eye
Instrumentos de ojos



21

Also Available in Titanium
Auch in Titan
Aussi disponible en titane
También Disponible en Titanio

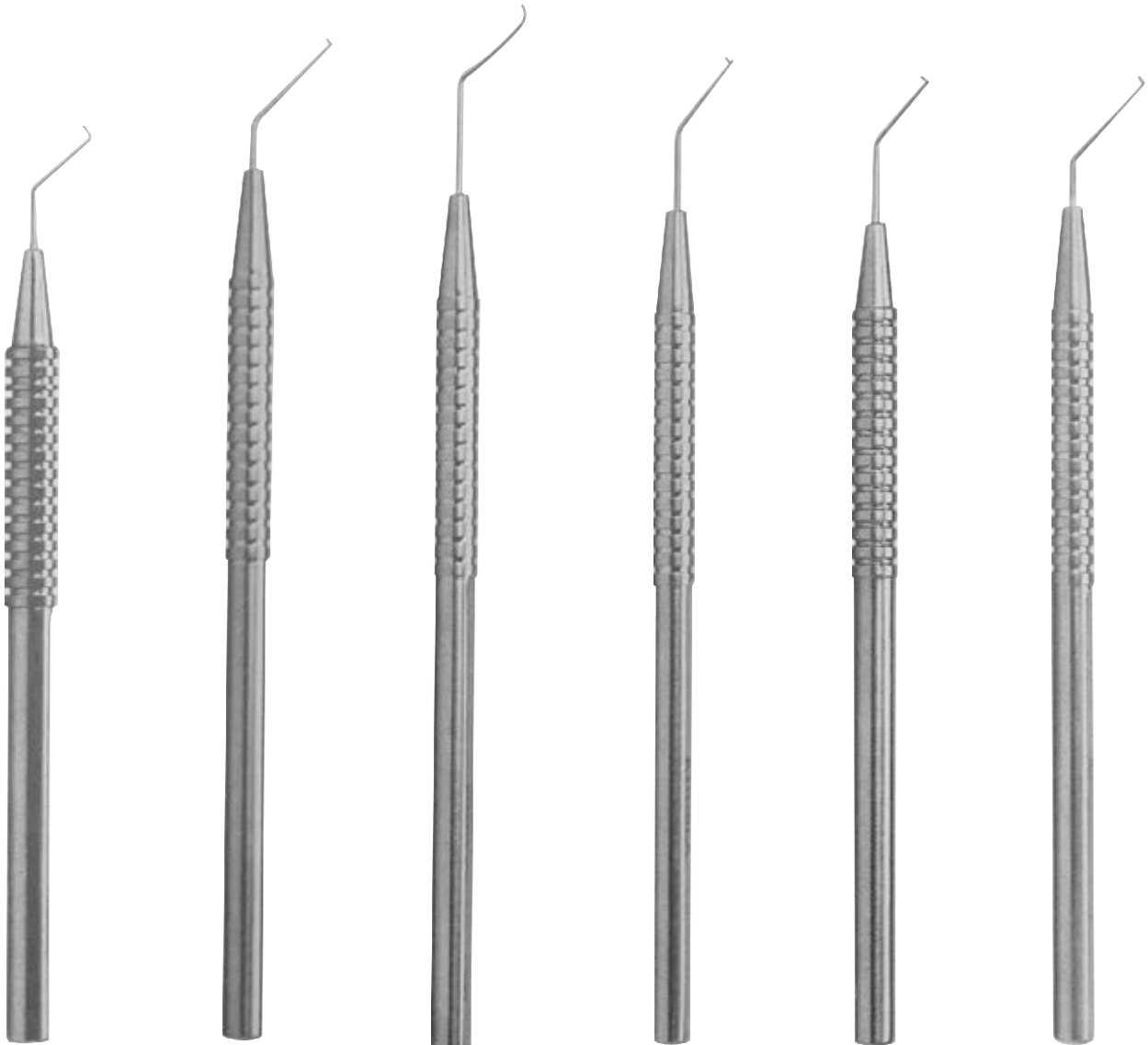

Nucleus sustainer
21-2801-78

Lieberman
21-2802-80

Koch
21-2803-80

Fukasaku
21-2804-84

Magahara
21-2805-86

Rosen
21-2806-88

Also Available in Titanium
Auch in Titan
Aussi disponible en titane
También Disponible en Titanio



Castroviejo
21-2807-90
0.12 mm Teeth



Harms
21-2808-00
0.12 mm Teeth



Barraquer
21-2809-02
0.12 mm Teeth



Castroviejo
21-2810-04
0.12 mm Teeth



Castroviejo
21-2811-06
0.12 mm Teeth
0.3 mm Teeth



Bishop-Harmon
21-2812-0A
Iris Forceps 1 x 2
Teeth, 0.3 mm

Ophthalmology Instruments

Eye Instruments

Instruments Eye
Instrumentos de ojos



21

Eye Instruments

Also Available in Titanium
Auch in Titan
Aussi disponible en titane
También Disponible en Titanio



O'Gawa
21-2813-0S
21-2813-0C

Straight Curved
gerade Gebogene
droit courbe
recto Curvo



Harms-Jaffe
21-2814-0S
21-2814-0C

Straight Curved
gerade Gebogene
droit courbe
recto Curvo



Bechert-Mc Pherson
21-2815-14
11 mm



Kelman-Mc Pherson
21-2816-16
8 mm



Mc Pherson
21-2817-18



Mc Pherson
21-2818-20
Corneal Forceps,
1 x 2 Teeth

Ophthalmology Instruments

Eye Instruments
Eye Instruments

Instruments Eye
Instrumentos de ojos

Also Available in Titanium
Auch in Titan
Aussi disponible en titane
También Disponible en Titanio

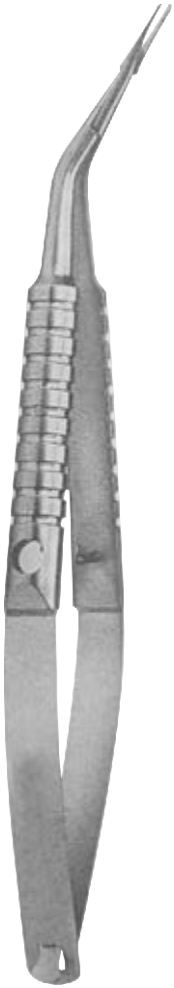

Fine
21-2819-22
Inserting Forceps



Steinert
21-2820-24
Universal Folding Forceps

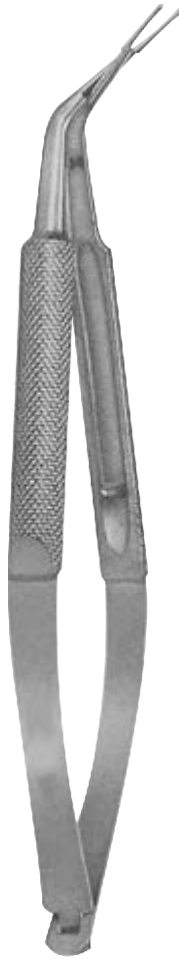

IOL Insertin Forceps
21-2821-26
21-2821-27

with lock without lock
mit Schloss ohne Schloss
avec serrure sans serrure
con cerradura sin cerradura



Livernois
21-2822-29
iol Holding Forceps



Livernois
21-2823-31
iol Holding and
Folding Forceps



Blaydes
21-2824-33
iol Inserting
Forceps

Ophthalmology Instruments

Eye Instruments
Eye Instruments

Instruments Eye
Instrumentos de ojos



21

Also Available in Titanium
Auch in Titan
Aussi disponible en titane
También Disponible en Titanio

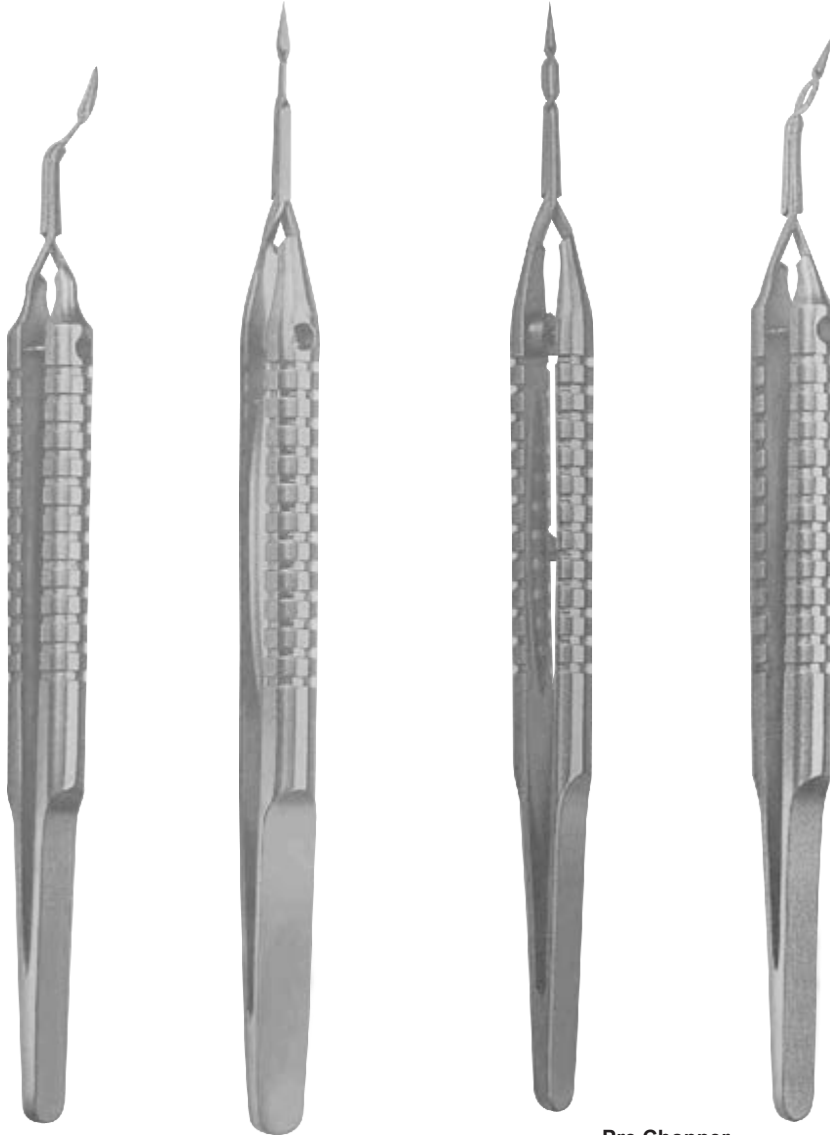

Pre Chopper for Soft Cataracts

21-2825-S
21-2825-C
21-2825-A

Straight gerade droit recto	Curved Gebogene courbe Curvo	Angled Angled incliné angular
--------------------------------------	---------------------------------------	--

Pre Chopper
21-2826-S
21-2826-A

Straight gerade droit recto	Curved Gebogene courbe Curvo
--------------------------------------	---------------------------------------

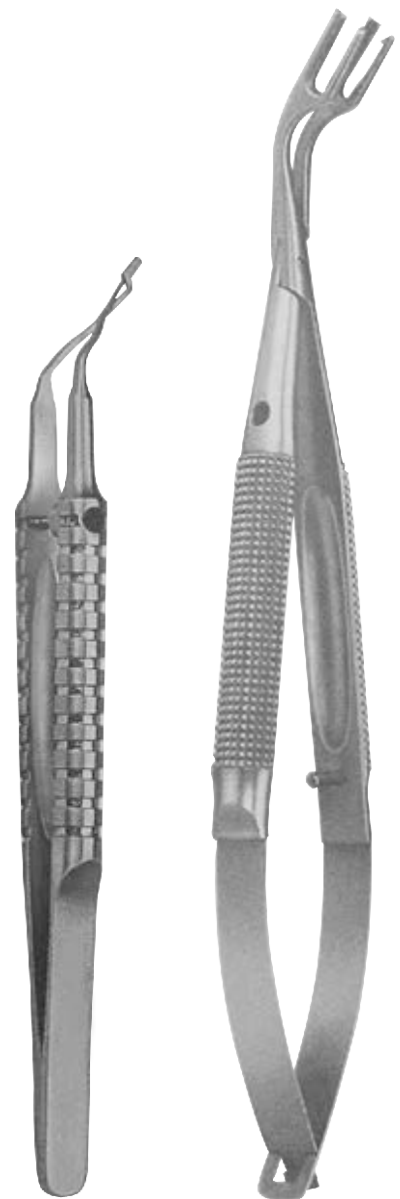

Arnest
21-2827-39

Koch
21-2828-41
Universal Lens Folder

Ophthalmology Instruments

Eye Instruments
Eye Instruments

Instruments Eye
Instrumentos de ojos

Also Available in Titanium
Auch in Titan
Aussi disponible en titane
También Disponible en Titanio



Utrata
21-2829-43
Capsulorhexis Forceps
Systotome Tip
Systotome Tip
Systotome Conseil
Systotome Consejo
11 mm



Utrata
21-2830-45
Capsulorhexis Forceps
Systotome Tip
Systotome Tip
Systotome Conseil
Systotome Consejo
11 mm



Masket
21-2831-47
Capsulorhexis Forceps
Systotome Tip
Systotome Tip
Systotome Conseil
Systotome Consejo
11 mm



Utrata
21-2832-49
Capsulorhexis Forceps
Systotome Tip
Systotome Tip
Systotome Conseil
Systotome Consejo
11 mm



Utrata
21-2833-51
Capsulorhexis Forceps
Systotome Tip
Systotome Tip
Systotome Conseil
Systotome Consejo
11 mm

Ophthalmology Instruments

Eye Instruments
Eye Instruments

Instruments Eye
Instrumentos de ojos



21

Also Available in Titanium
Auch in Titan
Aussi disponible en titane
También Disponible en Titanio

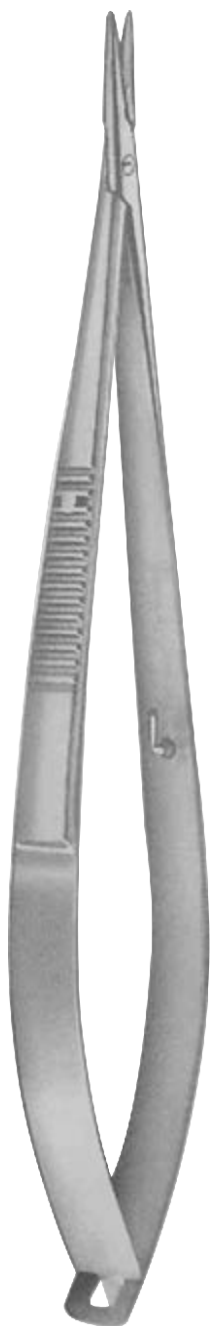

Castroviejo
21-2834-A
21-2834-B
Needle Holder

with lock	without lock
mit Schloss	ohne Schloss
avec serrure	sans serrure
con cerradura	sin cerradura

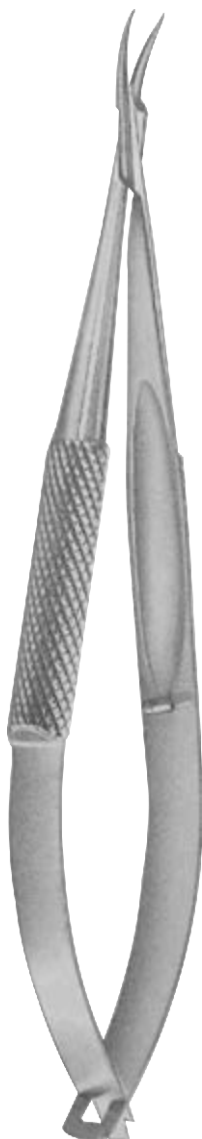

Barraquer
21-2835-CB
Needle Holder

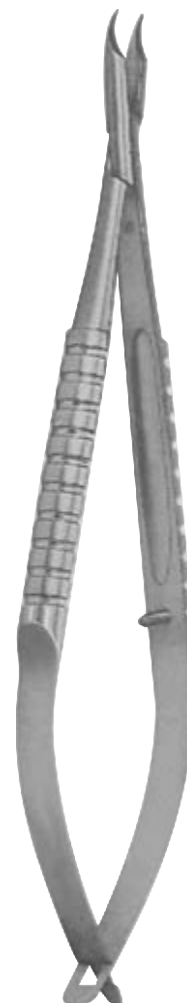

Micro Needle Holder
21-2836-57

Ophthalmology Instruments

Vitreoretinal Instruments
Vitreoretinal Instruments

Instruments Vitreoretinal
Instrumentos Vitreoretinal



Retinal Membrane
21-2837-59



Retinal Spatula
21-2838-61
Triangular Tip
dreieckige Spitze
Astuce triangulaire
Consejo triangular
0.5 mm



Retinal Spatula
21-2839-63
Triangular Tip
dreieckige Spitze
Astuce triangulaire
Consejo triangular
0.5 mm

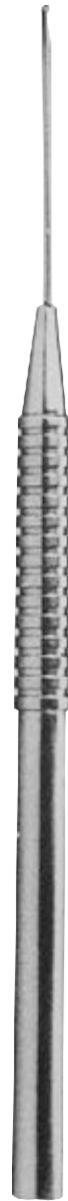

21-2840-65
Membrane Peeler



21-2841-67
Membrane Spatula
Hooked

Ophthalmology Instruments

Rk/Prk/Lasik Instruments
Rk / PRK / Lasik Instruments

Rk / PRK / Lasik Instruments
Rk / PRK / Instrumentos de Lasik



21



Thornton
21-2842-69



Fine-Thornton
21-2843-A 13mm
21-2843-B 16mm



Hafmann Thornton
21-2844-C 13mm
21-2844-D 16mm



Globe Fixation Ring
21-2845-75
12mm



Atraumatic Phaco
21-2846-77
12mm

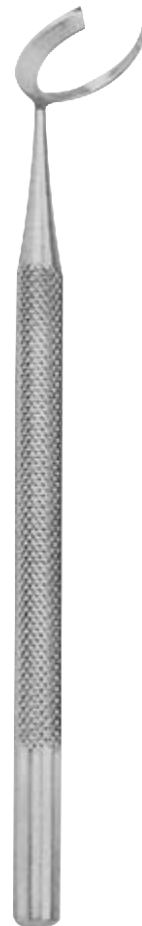

Atraumatic Phaco
21-2847-79
12mm Inside
16mm Outside

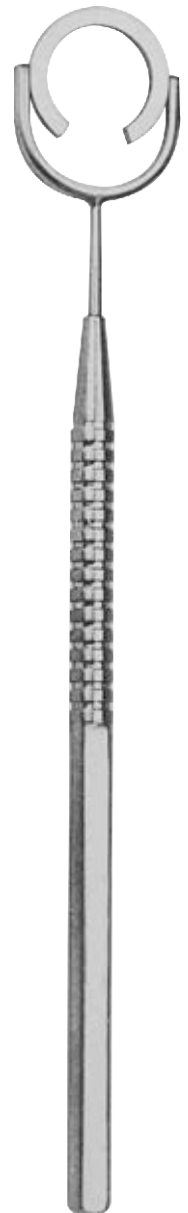

Ophthalmology Instruments

Rk/Prk/Lasik Instruments
Rk / PRK / Lasik Instruments

Rk / PRK / Lasik Instruments
Rk / PRK / Instrumentos de Lasik



Paton
21-2848-81



Fukasaku
21-2849-83
Lasik Spatula



Hockey Knife
21-2850-85



Lasik
21-2851-87

Flat Spatula for elevating
the flap on one end
Flache Spatel für elevating die
Klappe an einem Ende
Spatule plate pour elevating le
rabat sur une extrémité
Espátula Piso en elevating la
solapa en uno de los extremos



Pettigrove
21-2852-89
PRK Marker / Spatula



Maloney
21-2853-91

Intra Operative Keratometer Titanium only
Intra Operative Keratometer Titanium nur
Intra Operative Kératomètre titane seulement
Queratómetro intraoperatoria titanio sólo

Ophthalmology Instruments

Rk/Prk/Lasik Instruments
Rk / PRK / Lasik Instruments

Rk / PRK / Lasik Instruments
Rk / PRK / Instrumentos de Lasik



21



Mendez
21-2854-93

Multi Purpose Lasik Forceps
Multi Purpose Lasik Forceps
Multi Purpose Lasik Forceps
Multi Purpose Pinzas Lasik



Lasik
21-2855-95

Flap Forceps
Flap Forceps
Pincès à rabat
Pinzas Flap



Mendez
21-2856-97

Degree Gauge
Gradscheibe
Jauge degré
Grado Gauge

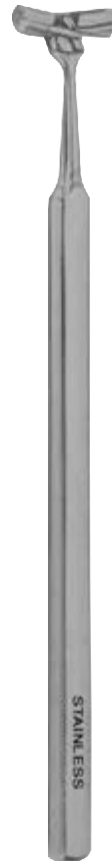

Bores
21-2857-99
Axis Marker
Achse Marker
marqueur axe
Axis Marker

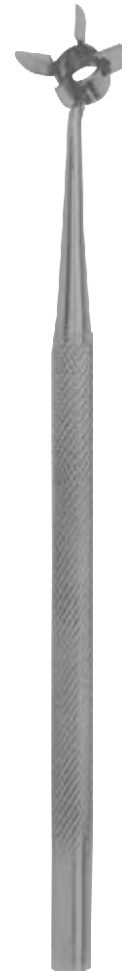

21-2858-A 4 lines
21-2859-02 6 lines
21-2860-04 8 lines
21-2861-06 12 lines
21-2862-08 16 lines

Comeal Marker
Comeal Marker
marqueur cornéen
marcador corneal



Deitz
21-2863-10
Incision Depth Gauge

Ophthalmology Instruments

Rk/Prk/Lasik Instruments
Rk / PRK / Lasik Instruments

Rk / PRK / Lasik Instruments
Rk / PRK / Instrumentos de Lasik



Hoffer

Optical Zone Marker
Optical Zone Marker
Marqueur Zone Optical
Marcador de Zona Optical

- 21-2864 -12 2.50mm
- 21-2865 -13 2.75mm
- 21-2866 -14 3.00mm
- 21-2867 -15 3.25mm
- 21-2868 -16 3.50mm
- 21-2869 -17 3.75mm
- 21-2870 -18 4.00mm
- 21-2871 -19 4.25mm
- 21-2872 -20 4.50mm
- 21-2873 -21 4.75mm
- 21-2874 -22 5.00mm
- 21-2875 -23 5.50mm
- 21-2876 34 6.00mm
- 21-2877 -25 6.50mm
- 21-2878 -26 7.00mm
- 21-2879 -27 7.50mm
- 21-2880 -28 8.00mm
- 21-2881 -29 8.50mm
- 21-2882 -30 9.00mm
- 21-2883 -31 9.50mm
- 21-2884 -32 10.0mm



Thornton

Optical Zone Marker
Optical Zone Marker
Marqueur Zone Optical
Marcador de Zona Optical

- 21-2885 -33 3.00mm
- 21-2886 -34 3.25mm
- 21-2887 -35 3.50mm
- 21-2888 -36 3.75mm
- 21-2889 -37 4.00mm
- 21-2890 -38 4.25mm
- 21-2891 -39 4.50mm
- 21-2892 -40 4.75mm
- 21-2893 -41 5.00mm
- 21-2894 -42 6.00mm
- 21-2895 -43 6.50mm
- 21-2896 -44 7.00mm
- 21-2897 -45 8.00mm
- 21-2898 -46 9.00mm

Ophthalmology Instruments

Rk/Prk/Lasik Instruments
Rk / PRK / Lasik Instruments

Rk / PRK / Lasik Instruments
Rk / PRK / Instrumentos de Lasik

21



Bores

Optical Zone Marker
Optical Zone Marker
Marqueur Zone Optical
rMarcador de Zona Optical

21-2899 -48	2.50mm
21-2900 -49	2.75mm
21-2901 -50	3.00mm
21-2902 -51	3.25mm
21-2903 -52	3.50mm
21-2904 -53	3.75mm
21-2905 -54	4.00mm
21-2906 -55	4.25mm
21-2907 -56	4.50mm
21-2908 -57	4.75mm
21-2909 -58	5.00mm
21-2910 -59	6.00mm
21-2911 -60	7.00mm
21-2912 -61	8.00mm



Double Marker
21-2913-62
3-5mm



Treple Marker
21-2914-64
3-5-7mm

Ophthalmology Instruments

Rk/Prk/Lasik Instruments
Rk / PRK / Lasik Instruments

Rk / PRK / Lasik Instrumentos
Rk / PRK / Instrumentos de Lasik

Grandon

- 21-2915-01 2.5mm wide
- 21-2915-02 2.5mm wide
- 21-2915-03 3.0mm wide
- 21-2915-04 4.0mm wide
- 21-2915-05 5.0mm wide

wide
breite
large
ancho

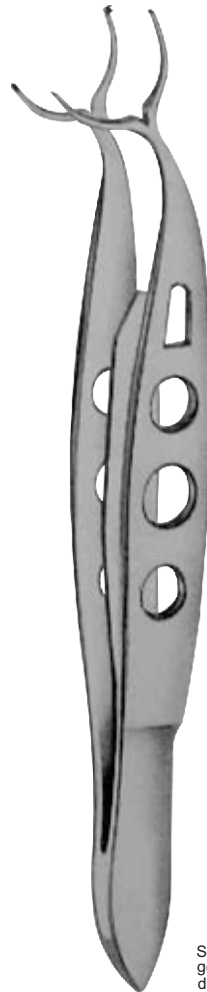

Straight
gerade
droit
recto

Curved
Gebogene
courbé
Curvo

Kremer

- 21-2916-S
- 21-2916-C

Corneal Fixation Forceps
13mm Spread 12mm Teeth
Corneal Fixierpinzette
13mm verteilen 12mm Zähne
Pince de fixation cornéen
13mm Fais dents 12mm
Pinza corneal fijación
13mm 12mm Corre Dientes



Straight
gerade
droit
recto

Curved
Gebogene
courbé
Curvo

Arrow smith

- 21-2917-S Straight
- 21-2917-C Curved

Corneal Fixation Forceps
8mm Spread 12mm Teeth
Corneal Fixierpinzette
8mm verteilen 12mm Zähne
Pince de fixation cornéen
8mm Fais dents 12mm
Pinza corneal fijación
8mm 12mm Corre Dientes



Straight
gerade
droit
recto

Curved
Gebogene
courbé
Curvo

Bores

- 21-2918-S
- 21-2918-C

Corneal Fixation Forceps
3mm Spread 12mm Teeth
Corneal Fixierpinzette
3mm verteilen 12mm Zähne
Pince de fixation cornéen
3mm Fais dents 12mm
Pinza corneal fijación
3mm 12mm Corre Dientes

Ophthalmology Instruments

Phaco Accessories
Phako-Zubehör

Phaco Accessoires
Faco Accesorios



21

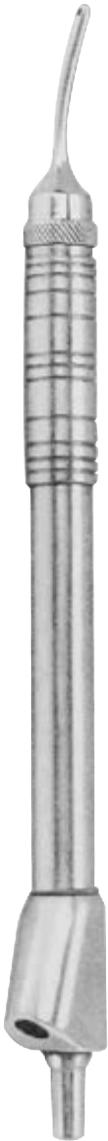

24-0269-59

- 21-2919-S Straight, straight, straight, straight
- 21-2919-C Curved, Gebogene, courbe, Curvo
- 21-2919-45 45° Angled, Angled, incliné, angular
- 21-2919-90 90° Angled, Angled, incliné, angular
- 21-2919-SI Simcoe,
- 21-2919-B Binklorst

Irrigation/Aspiration Handpiece
0.5mm Dual Sideports
Irrigation / Aspiration Handstück
0.5mm Dual-Seitenöffnungen
Irrigation / Aspiration pièce à main
0.5mm orifices latéraux à double
Irrigación / Aspiración Handpiece
0.5mm Sideports Dual



- 21-2920-15 15°
- 21-2920-30 30°
- 21-2920-45 45°

- 21-2921-01 Tip 30° Curved 5°
- 21-2921-02 Tip 30° Curved 20°
Curved Tip



21-2922-00

Handpiece For
Phaco emulsification
Handstück für
Phaco emulsification
Pièce à main pour
phaco emulsification
pieza de mano para
Faco emulsification



21-2923-00

Irrigation Silicone Sleeve
Non Sterile-(pcs/pack)
Bewässerung Silikonhülle
Non Sterile-(Stück / Packung)
Silicone Sleeve irrigation
Non Stérile-(pcs / paquet)
Riego Funda de silicona
No Estéril-(unidades / paquete)

Ophthalmology Instruments

Lid Retractors and Retractors
Deckel und Retraktoren Retraktoren

Rétracteurs et rétracteurs
Retradores del párpado y retractoros



Desmarres

- 21-2927-00 Infant 7.5mm
- 21-2927-01 Child 11mm
- 21-2927-02 Small 13mm
- 21-2927-03 Medium 15mm
- 21-2927-04 Large 17mm

Infant	Child	Small	Medium	Large
Säugling	Kind	klein	Medium	groß
nourrisson	enfant	petit	moyen	grand
infantil	niño	pequeño	medio	grande



Jeffe

Lid Retractor
21-2924-01
21-2924-02

Pair, Paar, paire, par

Small Pair, kleine Paar, Paire petit, pequeño par

Large Pair, große Paar, Paire grande, gran par

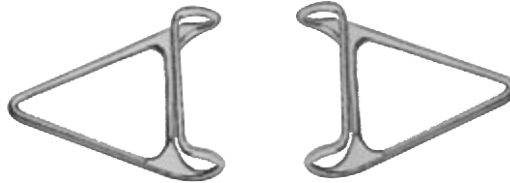

Newell

Lid Retractor Pair
21-2925-75

Pair
Paar
paire
par



Tennant

Lid Retractor Pair
21-2926-76

Pair
Paar
paire
par



Sharp	blunt
scharf	stumpf
net	émousser
agudo	embotar

Axenfeld

Lacrimal Sac
Retractor
3 Prong

21-2929-79 Sharp
21-2929-80 Blunt



Sharp	blunt
scharf	stumpf
net	émousser
agudo	embotar

Knapp

Lacrimal Sac
Retractor
4 Prong

21-2930-01 Sharp
21-2930-02 Blunt



Rollet

Lacrimal Sac
Retractor

21-2928-77 Sharp
21-2928-78 Blunt

Ophthalmology Instruments

Iris Retractors
Iris Retraktoren

Rétracteurs Iris
Los retractoros de iris

21



Rosenbaum-Drews

21-2931-84 Left and Right
21-2931-L
21-2931-R

Left	Right
links	rechts
links	droit
Izquierda	derecho

Rizzuti

Iris Retractor and Lens
Expressor
21-2932-85



Roger

Iris Retractor
21-2933-S
21-2933-L
21-2933-R



Spivey

Iris Retractor
21-2934-87



Graether

Collar Button Iris
Retractor

21-2935-S	Straight
21-2935-A	Angled
21-2935-B	Angled Left
21-2935-C	Angled Right

Straight	Angled
gerade	Angled
droit	incliné
recto	angular

Ophthalmology Instruments

Muculus Splitters
Muculus Splitter

Splitters Muculus
Muculus Splitter



Kansas
Lens Loop Serrated wide
Objektiv Schleife Serrated breit
Objectif boucle crantée large
Lens Loop dentada ancho
21-2936-89



Kansas
Nucleus Trisector
for manual Small
incision surgery
21-2937-90



Kansas
Nucleus Bisector
for manual Small
incision surgery
21-2938-91

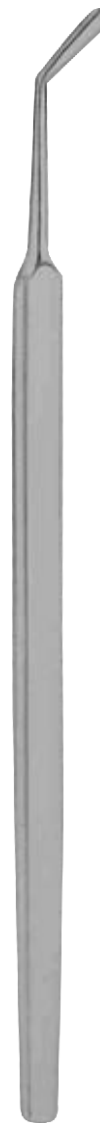

Kansas
Nucleus Vectis Solid
used as cutting block
with Kansas insector &
Bbisector for nucleus
fragmentation
21-2939-92

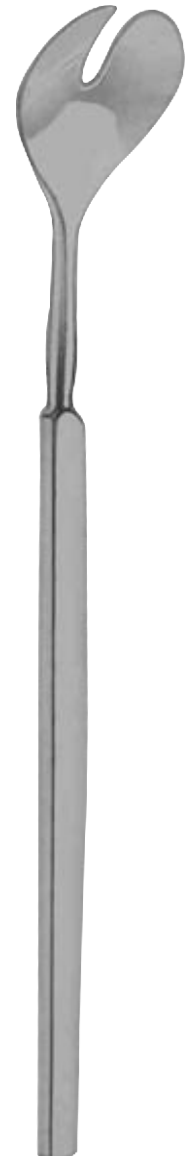

Wells
Enucleation Spoon
21-2940-93

Ophthalmology Instruments

Spoons & Curettes
Löffel & Küretten

Cuiller et Curettes
Cucharas y Curetas



21



Pagenstecher

EueSpoon
21-2941-94

wide
breite
large
ancho



Bunge

Evisceration Spoon
21-2942-01 8.0mm
21-2942-02 9.0mm
21-2942-03 10.0mm
21-2942-04 11.0mm
21-2942-05 12.0mm



Hebra

Chalazion Curette, Sharp
21-2943-01 2.5mm
21-2943-02 3.5mm
21-2943-03 4.5mm

Sharp
scharf
net
agudo



Meyhoefer

Chalazion Curette,
Sharp 1mm
21-2944-A

Sharp
scharf
net
agudo



Meyhoefer

Chalazion Curette, Sharp
21-2944-00 1.50mm
21-2944-01 1.75mm
21-2944-02 2.75mm
21-2944-03 2.50mm
21-2944-04 3.50mm

Sharp
scharf
net
agudo

Ophthalmology Instruments

Lacrimal Instruments
lacrimal Instruments

Instruments lacrymales
Instrumentos lagrimal

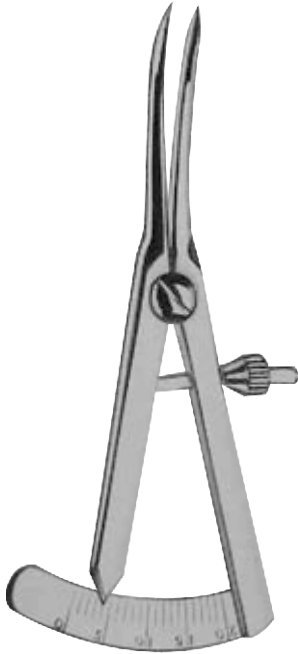

Castroviejo
Caliper 15mm
21-2945-A
21-2945-B

Straight
gerade
droit
recto

Curved
Gebogene
courbé
Curvo



Castroviejo
Caliper 20mm
21-2945-C
21-2945-D



Left
links
links
Izquierda

Right
rechts
droit
derecho

Harms
Trabeculotomy Probe
21-2945-E
21-2945-F

Ziegler
Probe for Lacrimal Canal
21-2945-G

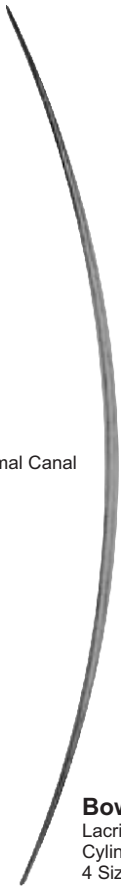

Bowman
Lacrimal Probe
Cylindrical Set of
4 Sizes
21-2945-H

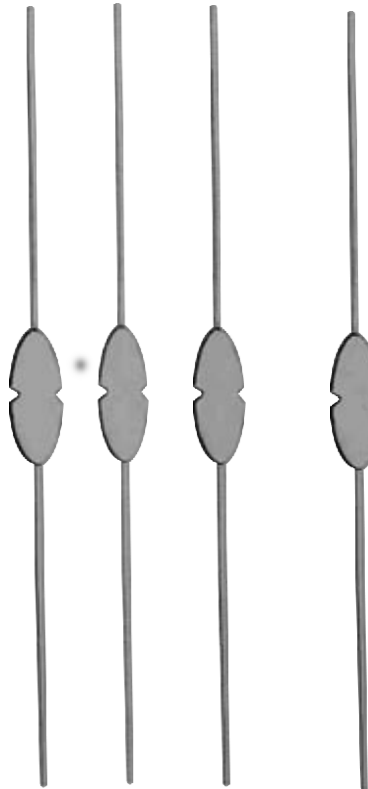

Role
Probe
LacrimalSec
21-2945-J



Pigtail
Probe
21-2945-K
21-2945-L
21-2945-M

with suture holes
mit Nahtlöcher
avec trous de suture
con orificios de sutura

Curly type with suture holes
Curly Typ mit Nahtlöcher
Type bouclés avec des trous de suture
Tipo rizado con orificios de sutura

Ophthalmology Instruments

Curettes & Cautery
Küretten & Kautergriff

Curettes et cautérisation
Curetas y Cauterio



21



Axenfeld
Chalazion Curette,
Sharp Double End
21-2946-99

Sharp Double End
Sharp Double End
Fin nette Double
Doble fin de Sharp



Nightingale
Capsule Polishing
Curette 1.75mm
21-2947-00



Gille
Capsule Polishing
Curette 1.75mm
21-2948-01



Anis
Capsule Scrubber
21-2949-02



Wills Hospital
Cautery, Delicate
Copper Bail
21-2950-03



Wills Hospital
Cautery, Delicate
Copper Bail Tip
21-2951-04

Ophthalmology Instruments

Lacrimal Instruments
lacrimal Instruments

Instruments lacrymales
Instrumentos lagrimal

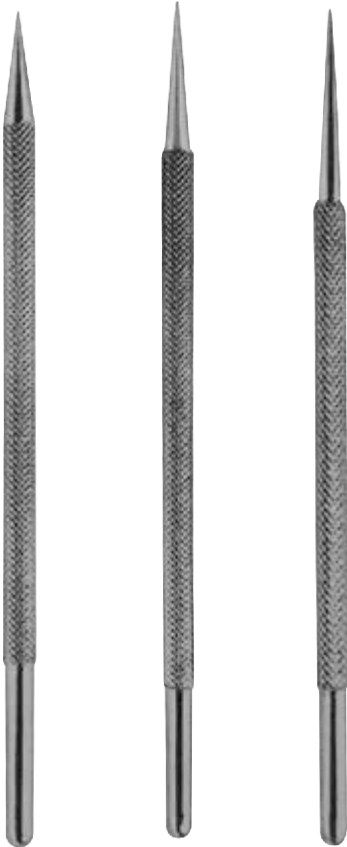

wilder

Lacrimal Dilator
21-2952-01
21-2952-02
21-2952-03

Fine Taper	Medium Taper	Heavy Taper
feine Taper	Medium Taper	schwere Taper
Taper fine	Taper moyen	Taper lourd
Taper Fine	Medium Taper	Taper pesado



Infant lacrimal Dilator
Very Fine Blunt Tip
21-2953-13

Blunt Tip
Blunt Tip
à bout arrondi
Blunt Tip



Castroviejo

lacrimal Dilator Double End
Fine & Medium Taper
21-2954-14

Medium Taper
Medium Taper
Taper moyen
Medium Taper



Dastoor

lacrimal Sac Dissector
Double End
21-2955-15

Double End
Double End
Fin Double
Fin Doble



Lang

lacrimal Sac Dissector
Double End
21-2956-16

Double End
Double End
Fin Double
Fin Doble

Ophthalmology Instruments

Lacrimale Instruments
lacrimale Instruments

Instruments lacrymales
Instrumentos lagrimal



21



Graefe
Scarifier for
lacrimale Sec
21-2957-17



Desmarres
Scarifier for
lacrimale Sec
21-2958-18



West
Bone Chisel Lacrimal
Sec Straight
21-2959-19

Straight
gerade
droit
recto



West
Bone Chisel
Lacrimal
Sec Curved
21-2960-20

Curved
gerade
droit
recto



Freer
Bone Chisel
Lacrimal
Sec Curved
21-2961-21

Curved
Gebogene
courbé
Curvo



Joseph
Periosteal Elevator
21-2962-22



Freer
Periosteal Elevator
Double End Sharp &
Blunt
21-2963-23

Sharp blunt
scharf stumpf
net émousser
agudo embotar

Ophthalmology Instruments

Punches Lacrimal Instruments
Punches Lacrimal Instruments

Poinçons lacrymale Instruments
Punzones lagrimal Instruments



Luntz-Dodick
Trabeculectomy Punch
Rotatable Cutting
21-2964-A 0.5mm Tip
21-2964-B 1.0mm Tip
21-2964-C 1.5mm Tip

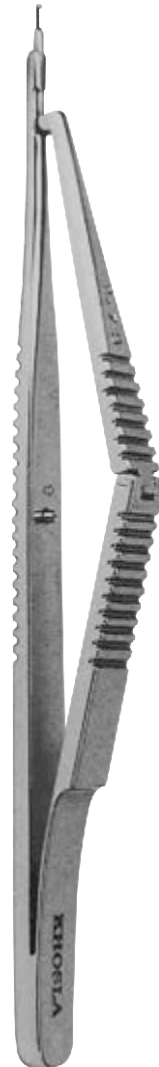

Kelley
Decemats Membrane Punch
21-2965-25 1.0mm Bite
21-2965-A 0.75mm Bite
Bite
beißen
mordre
morder

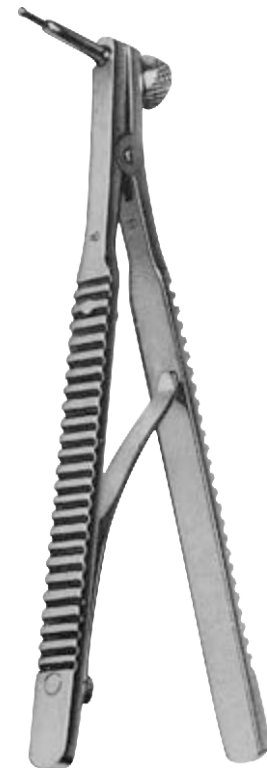

Gass
Comeoscleral Punch
1.0 mm dia
21-2966-26
Rotatable Tip
drehbaren Spitze
Astuce rotatif
Consejo giratoria

Ophthalmology Instruments

Rongeurs Instruments
Rongeur Instruments

Instruments Rongeurs
roedores Instruments

21



Beyer
Bone Rongeur
21-2967-27



Citelli
Bone Rongeur
21-2968-28

Ophthalmology Instruments

Rongeurs Instruments
Rongeur Instruments

Instruments Rongeurs
roedores Instruments

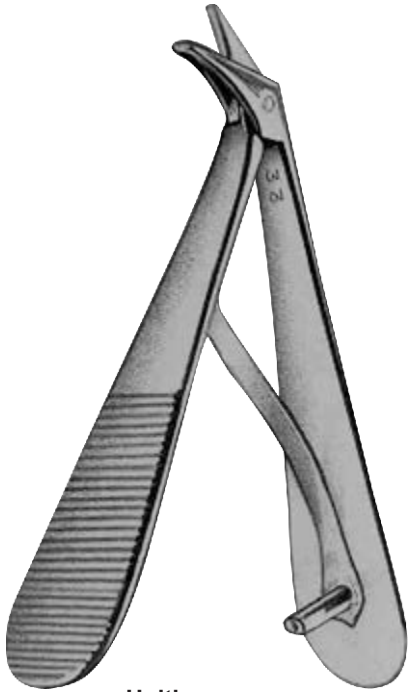

Holth

Comeoscleral Punch
21-2969-01 1mm
21-2969-02 1.5mm
21-2969-03 2mm



Adler

Bone Rongeur
21-2970-30



Kerrison

Bone Rongeur
21-2971-01
21-2971-02
21-2971-03

Small	Medium	Large
klein	Medium	groß
petit	moyen	grand
pequeño	medio	grande

Ophthalmology Instruments

Forceps forceps
Zange fórceps



21



Hartmann
Mosquito Forceps 3.25"
21-2972-S Straight
21-2972-C Curved

Straight Curved
gerade Gebogene
droit courbé
recto Curvo



Hasted
Mosquito Forceps 5.50"
21-2973-S Straight
21-2973-C Curved

Straight Curved
gerade Gebogene
droit courbé
recto Curvo



Serrefine
1.5"
21-2974-S Straight
21-2974-C Curved

Straight Curved
gerade Gebogene
droit courbé
recto Curvo



Backhaus
Towel Clamp
21-2975-01 3.50"
21-2975-02 5.25"



Jones
Towel Clamps
21-2976-36

Towel Clamp
Handtuch Clamp
Pince serviette
Toalla Clamp

Ophthalmology Instruments

Forceps forceps
Zange fórceps



Half Curved
halbgebogen
La moitié courbé
La mitad de curva

Iris Forceps
1 x 2 Teeth,
Half Curved
21-2977-37



Full Curved
Vollständige Curved
pleine courbe
completo Curved

Iris Forceps
1 x 2 Teeth, Straight
21-2978-38

Straight
gerade
droit
recto

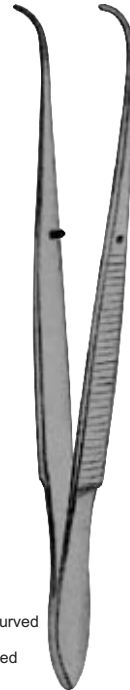

Eye Dressing Forceps
Serrated, Full Curved
21-2979-39



Half Curved
halbgebogen
La moitié courbé
La mitad de curva

Eye Dressing Forceps
Serrated, Half Curved
21-2980-40



Straight
gerade
droit
recto

Eye Dressing Forceps
Serrated, Straight
21-2980-41

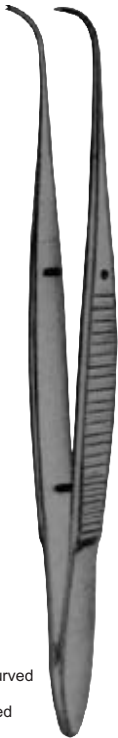

Full Curved
Vollständige Curved
pleine courbe
completo Curved

Iris Forceps
1 x 2 Teeth, Full Curved
21-2981-42



Bishop-Harmon
Iris Forceps 1x2 Teeth,
Extra Delicate
21-2982-A 0.3mm
21-2982-B 0.5mm
21-2982-43 Serrated



Hees
Iris Forceps Swiss
Model 1x2
21-2983-44



Straight
gerade
droit
recto

Utility Forceps
4" Serrated
Straight
21-2984-45



Straight
gerade
droit
recto

Utility Forceps
4" 1x2 Straight
21-2985-46

Ophthalmology Instruments

Forceps
Zange

forceps
fórceps

21



McCullough
Utility Forceps Serrated
21-2986-47



McCullough
Utility Forceps 1x2
Serrated
21-2987-48



Wills Hospital
Utility Forceps Serrated
21-2988-49



Bonaccolto
Utility Forceps Serrated
21-2989-50



Bonaccolto
Utility Forceps
Heavy Model
21-2990-50



without Catch
ohne Fang
sans Catch
sin capturas

Graefe
Fixation Forceps
21-2991-51 without Catch



without Catch
ohne Fang
sans Catch
sin capturas

Waldau
Fixation Forceps
21-2992-52 without Catch



Schmidt-Rimpler
Fixation Forceps
21-2993-53



Jees
Fixation Forceps
21-2994-54



Barraquer
Fixation Forceps
21-2995-55



Troutman-LLobera
Fixation Forceps
21-2996-56

Ophthalmology Instruments

Forceps
Zange

forceps
fórceps



Green
Fixation Forceps
21-2997-01 5mm
21-2997-02 10mm



Elschnig
Fixation Forceps
21-2998-58



Kuhnt
Fixation Forceps
21-2999-59



Fixation Forceps 4.50:
1 x 2 Teeth
21-3000-60

1 x 2 Teeth
1 x 2 Zähne
1 x 2 dents
1 x 2 dientes



Fixation Forceps 4.50"
1 x 2 Teeth
21-3001-61

1 x 2 Teeth
1 x 2 Zähne
1 x 2 dents
1 x 2 dientes



Fixation Forceps 4.25"
2 x 3 Teeth
21-3002-62

2 x 3 Teeth
2 x 3 Zähne
2 x 3 dents
2 x 3 dientes



Lester
Fixation Forceps
21-3003-01 1 x 2 Teeth
21-3003-02 3 x 3 Teeth

1 x 2 Teeth 3 x 3 Teeth
1 x 2 Zähne 3 x 3 Zähne
1 x 2 dents 3 x 3 dents
1 x 2 dientes 3 x 3 dientes

Ophthalmology Instruments

Forceps
Zange

forceps
fórceps

21



Harms
Colibri Forceps
0.12mm
21-3004-64



Castroviejo
Colibri Forceps
0.12mm
21-3005-65



Polack
Double Corneal Forceps
10mm spread 0.12mm
21-3006-66



Cohan
Colibri Forceps
0.3mm Teeth
21-3007-67



Pierse
Corneal Colibri Forceps
1 x 1 Pierse Teeth, Delicate
21-3008-01 0.1mm
21-3008-02 0.3mm



Pierse
Corneal Colibri Forceps
1 x 1 Pierse Teeth,
Delicate Straight
21-3009-01 0.1mm
21-3009-02 0.3mm



Moorfield
Suture Forceps
21-3010-70



with Teeth & Platform
mit Zähnen & Platform
avec les dents et la plate-forme
con dientes y plataforma
Girard
Corneal Scleral Forceps
with Teeth & Platform
21-3011-71

Ophthalmology Instruments

Forceps
Zange

forceps
fórceps

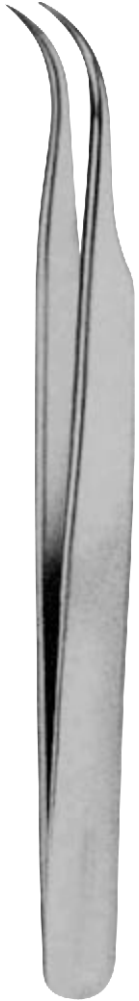

Jewelers
Forceps
21-3012-71



Jewelers
Forceps
21-3013-71



Jewelers
Forceps
21-3014-71



Jewelers
Forceps
21-3015-71

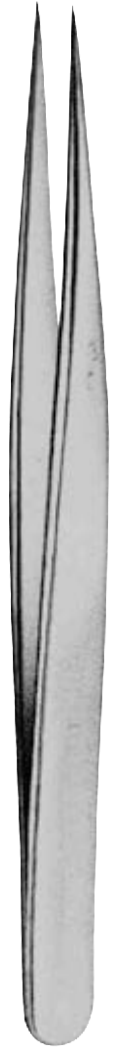

Jewelers
Forceps
21-3016-71

Ophthalmology Instruments

Forceps
Zange

forceps
fórceps

21



Lims
Forceps 1 x 2
Teeth very Delicate
21-3017-72



Mcperson
Comeal Forceps
1 x 2 Teeth
21-3018-S Straight
21-3018-A Angled



Mcperson
Tying Forceps,
21-3019-S Straight
21-3019-A Angled



Kelman-Mcperson
Forceps 8mm Angled
21-3020-75 1 x 2 Teeth
21-3020-75 Smooth



Bechert-Mcperson
Forceps, 11mm Angled
21-3021-76

Angled
Angled
incliné
angular

Straight
gerade
droit
recto

Angled
Angled
incliné
angular

Straight
gerade
droit
recto

Angled
Angled
incliné
angular



Tying
Forceps without
Teeth
21-3022-77



Harms-Jafe
Tying Forceps
21-3023-S
21-3023-C



Sinskey
Tying Forceps
21-3024-S
21-3024-C



Tennant
Tying Forceps
21-3025-S
21-3025-C



O'Gawa
Tying Forceps
21-3026-S
21-3026-C

Ophthalmology Instruments

Forceps forceps
Zange fórceps



Blaydes
IOL, Insertion
Forceps
21-3027-82



Clayman
Lens Holding Forceps
21-3028-83



Shepard
IOL, Forceps, Oval Tip
21-3029-84 without Lock
21-3029-84A with Lock

with lock without lock
mit Schloss ohne Schloss
avec serrure sans serrure
con cerradura sin cerradura



Bechert
Lens Holding Forceps
21-3030-85



Faulkner
Lens Holding Forceps
21-3031-86



Faulkner
Lens Holding Forceps
21-3032-87



Bonaccolta
Capsules Fragment
Forceps
21-3033-88



Feaster
Lens Holding Forceps
21-3034-89

Ophthalmology Instruments

Forceps
Zange

forceps
förceps

21



Kraff
Capsule Tag
Forceps 11mm
21-3035-90



Barraquer
Cilia Forceps
21-3036-91



Beer
Cilia Forceps
21-3037-92



Ziegler
Cilia Forceps
21-3038-93



Utrata
Capsulorhexis Forceps
Cystotome Tips, 11mm Long thin
21-3039-94

Cystotome Tips,
11mm Long thin
Cystotome Tipps,
11mm Lange dünne
Conseils cystotome,
11mm long et mince
Consejos cistitomo
11mm, largo y delgado



Utrata
Capsulorhexis Forceps
Cystotome Tips, 11mm Long thin
21-3040-95

Cystotome Tips,
11mm Long thin
Cystotome Tipps,
11mm Lange dünne
Conseils cystotome,
11mm long et mince
Consejos cistitomo
11mm, largo y delgado



Masket
Capsulorhexis Forceps
Cystotome Tips, 11mm Long Curved
21-3041-96

Cystotome Tips,
11mm Long Curved
Cystotome Tipps,
11mm Lange Gebogene
Conseils cystotome,
11mm long courbe
Consejos cistitomo
11mm, largo Curvo

Ophthalmology Instruments

Forceps
Zange

forceps
fórceps



Cystotome Tips,
11mm Long Curved
Cystotome Tipps,
11mm Lange Gebogene
Conseils cystotome,
11mm long courbe
Consejos cistitomo
11mm, largo Curvo

Utrata

Capsulorhexis Forceps
Cystotome Tips,
11mm Long Curved
21-3042-97



Cystotome Tips,
11mm Long Curved
Cystotome Tipps,
11mm Lange Gebogene
Conseils cystotome,
11mm long courbe
Consejos cistitomo
11mm, largo Curvo

Utrata

Capsulorhexis Forceps
Cystotome Tips,
11mm Long Curved
21-3043-98



Livernois

IOL Holding & Folding
Forceps
21-3044-99



Livernois

IOL Holding Forceps
21-3045-00



with lock mit Schloss avec serrure	without lock ohne Schloss sans serrure
21-3046-01	21-3046-01
with lock	without lock



Soft IOL Inserting Forceps
21-3047-02



Steinert
Universal Folding
Forceps
21-3048-03



Fine
Inserting Forceps
21-3049-04



Koch
Universal Lens
Folder for Silicone
Lenses
21-3050-05

Ophthalmology Instruments

Forceps
Zange

forceps
fórceps

21



Ernest
Nucleus Cracker
21-3051-06



Sharp Tips
Sharp Tipps
Conseils pointus
Punta aguda

Pre-Chopper
Sharp Tips
Maximum Oppening
2.8mm
21-3052-07



Pre-ChopperFor
Soft Cataracts
Wider Jaw Help
Split Soft Nucleus
21-3053-08



Berke
Ptosis Clamp. 20mm
21-3054-09

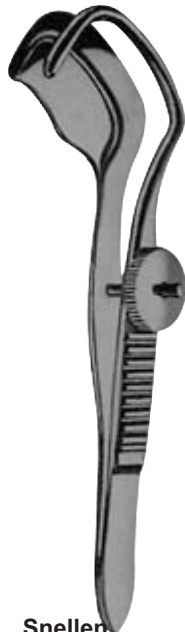

Snellen
Entropium Forceps
21-3055-10



Ayer
Chalazion Forceps
21-3056-11 without Stop Screw
21-3056-11 with Stop Screw

without Stop Screw
ohne Anschlagsschraube
sans vis de butée
sin tornillo de parada

with Stop Screw
mit Anschlagsschraube
avec vis d'arrêt
con tornillo de parada



Lambert
Chalazion Forceps
21-3057-12



Hunt
Chalazion Forceps
21-3058-13

Ophthalmology Instruments

Forceps & Bipolar Forceps
Pinzetten & Bipolarzangen

Pince & pince bipolaire
Pinzas y pinzas bipolares



Desmarres
Chalazion Forceps Oval
21-3059-00 15mm
21-3059-01 20mm
21-3059-02 26mm
21-3059-03 31mm



Erhardt
Lid Forceps
21-3060-15



Heath
Chalazion Forceps
21-3061-16



Lordan
Chalazion Forceps
21-3062-17



Coaptation
Bipolar Forceps
21-3063-18



McPherson
Bipolar Forceps
21-3064-19 Straight
21-3064-19A Angled

Straight
gerade
droit
recto

Angled
Angled
incliné
angular



Colibri
Bipolar Forceps
21-3065-20



Jewelers
Bipolar Forceps
21-3066-21

Ophthalmology Instruments

Hoskine Forceps
Hoskine Zange

Hoskine Forceps
Hoskine Pinzas

21



Pieris-Hoskin
Fixation Forceps
21-3067-22



Pieris-Hoskin
Fine Forceps,
Straight
21-3068-23

Straight
gerade
droit
recto



Pieris-Hoskin
Large Forceps
Angled
21-3069-24

Angled
Angled
incliné
angular



Pieris-Hoskin
Micro Forceps,
Straight
21-3070-25

Curved
Gebogene
courbé
Curvo



Pieris-Hoskin
Micro Forceps,
Curved
21-3071-26

Curved
Gebogene
courbé
Curvo



Pieris-Hoskin
Suture Forceps
21-3072-27



Pieris-Hoskin
Sekelton Fine
Forceps
21-3073-28



Pieris-Hoskin
Sekelton Micro
Forceps
21-3074-29



Pieris-Hoskin
Sekelton Fixation
Forceps
21-3075-30



Pieris-Hoskin
Fine Beaked Coliton
Forceps
21-3076-31



Pieris-Hoskin
Fine Beaked Micro
Coliton Forceps
21-3077-32

Ophthalmology Instruments

Scissors ciseaux
Schere tijeras



Iris Scissors 3 1/2"
21-3078-33 Straight
21-3079-34 Curved
21-3080-35 Angled

Straight	Curved	Angled
gerade	Gebogene	Angled
droit	courbé	incliné
recto	Curvo	angular



Iris Scissors 4 1/8"
21-3081-36 Straight
21-3082-37 Curved

Straight	Curved
gerade	Gebogene
droit	courbé
recto	Curvo



Iris Scissors 4 1/2"
21-3083-38 Straight
21-3084-39 Curved

Straight	Curved
gerade	Gebogene
droit	courbé
recto	Curvo

Knapp
Iris Scissors 4 1/2"
21-3085-S Straight
21-3085-C Curved
21-3086-S Straight
21-3086-C Curved

Straight	Curved
gerade	Gebogene
droit	courbé
recto	Curvo



Eye Scissors 5" Pointed
21-3087-S Straight
21-3087-C Curved

Straight	Curved
gerade	Gebogene
droit	courbé
recto	Curvo

Ophthalmology Instruments

Scissors ciseaux
Schere tijeras

21



Striaight Blunt	Curved Blunt
Straight Pointed	Curved Pointed
Gerade Spitz	Gebogene Pointed
Droit pointu	courbé pointu
Straight punta	Curva punta

Stevens
Tenotomy Scissors,
New Model
21-3088-S Straight Blunt
21-3089-S Straight Pointed
21-3090-C Curved Blunt
21-3091-C Curved Pointed

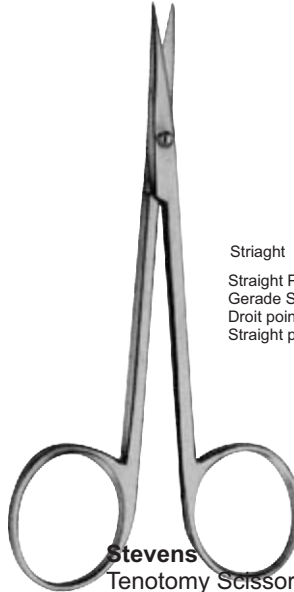

Striaight Blunt	Curved Blunt
Straight Pointed	Curved Pointed
Gerade Spitz	Gebogene Pointed
Droit pointu	courbé pointu
Straight punta	Curva punta

Stevens
Tenotomy Scissors,
Long Model
21-3092-S Straight Blunt
21-3093-S Straight Pointed
21-3094-C Curved Blunt
21-3095-C Curved Pointed



Spencer
Stitch Scissors, 3.5"
21-3096-52

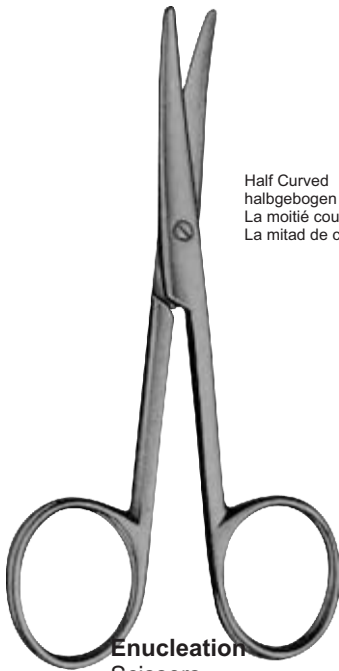

Half Curved	Full Cruved
halbgebogen	Vollständige Cruved
La moitié courbé	plein Cruved
La mitad de curva	completo Cruved

Enucleation
Scissors
21-3097-53 Half Curved
21-3098-54 Full Cruved



Half Curved	Full Cruved
halbgebogen	Vollständige Cruved
La moitié courbé	plein Cruved
La mitad de curva	completo Cruved

Bonn Model
Iris Scissors Delicate
21-3099-55 Half Curved
21-3100-56 Full Cruved

Ophthalmology Instruments

Scissors ciseaux
Schere tijeras

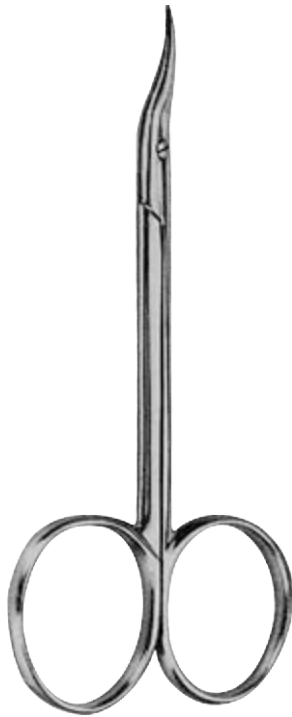

Mc Guire
Comeal Scissors
21-3101-57 Left
21-3102-58 Right

Left Right
links rechts
links droit
Izquierda derecho



De Mecker
Iris Scissors

21-3103-A Sharp Tips
21-3104-B Sharp & Blunt Tips
21-3105-C Blunt Tips

Sharp Tips
Sharp Tips
Conseils pointus
Punta aguda

Blunt Tips
Blunt Tips
Conseils Blunt
Consejos Blunt



Noves
Iris Scissors

21-3106-A Sharp Tips
21-3107-B Sharp & Blunt Tips
21-3108-C Blunt Tips

Sharp Tips
Sharp Tips
Conseils pointus
Punta aguda

Blunt Tips
Blunt Tips
Conseils Blunt
Consejos Blunt



Barraguer
Iris Scissors

21-3109-A 7mm Blade
21-3110-B 10mm Blade



Vannas
Capsulotomy Scissors
very delicate 6mm Blade
21-3111-S Straight
21-3112-C Curved
21-3113-A Angled

Straight Curved Angled
gerade Gebogene Angled
droit courbé incliné
recto Curvo angular



Gills-Welsh Vannas
Capsulotomy Scissors
very delicate 11mm Blade
21-3114-70



Gills Vannas
Capsulotomy Scissors
very delicate 11mm Blade
21-3115-S Straight
21-3116-C Curved

Straight Curved
gerade Gebogene
droit courbé
recto Curvo



Stern-Gills
Scissors 10mm
21-3117-73



Ubire-Stern
Scissors 10mm
21-3118-74

Ophthalmology Instruments

Scissors ciseaux
Schere tijeras

21

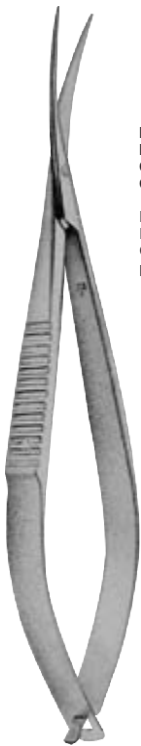

Blunt Tips
Blunt Tipps
Conseils Blunt
Consejos Blunt

Pointed Tips
Feine Spitzen
Conseils pointus
puntas

Westcott
Tenotomy Scissors,
Standard Blades
21-3119-75
21-3120-76



Blunt Tips
Blunt Tipps
Conseils Blunt
Consejos Blunt

Pointed Tips
Feine Spitzen
Conseils pointus
puntas

Westcott
Tenotomy Scissors,
Medium Blades
21-3121-77
21-3122-78



Blunt Tips
Blunt Tipps
Conseils Blunt
Consejos Blunt

Pointed Tips
Feine Spitzen
Conseils pointus
puntas

Mcperson-westcott
Stitch Scissors,
Small Blades
21-3123-79
21-3124-80



Jeffe
Stitch Scissors,
Medium Blades Sharp Tips
21-3125-79
21-3126-80



Castroviejo
Corneal Scissors,
Strong Curve, Blunt Tips
21-3127-81



Castroviejo
Corneal Scissors,
Slightly Curve, Blunt Tips
21-3128-82



Castroviejo
Minature Corneal
Scissors,
21-3129-83



Castroviejo
Minature Corneal
Scissors,
21-3130-84 Curved

Curved
Gebogene
courbé
Curvo



Castroviejo
Minature Corneal
Scissors, Blunt Tips
21-3131-85 Curved

Curved
Gebogene
courbé
Curvo

Ophthalmology Instruments

Scissors ciseaux
Schere tijeras



Castroviejo
Miniature Corneal
Scissors, Blunt Tips
21-3132-86

Angled
Angled
incliné
angular



Katzin
Miniature Corneal
Scissors,
21-3133-87 Right
21-3134-88 Left

Left Right
links rechts
links droit
Izquierda derecho



Katzin
Miniature Corneal
Scissors, Medium
Blade
21-3135-89 Right
21-3136-90 Left

Left Right
links rechts
links droit
Izquierda derecho



Castroviejo
Corneal Scissors,
Blunt Tips
21-3137-91

Angled
Angled
incliné
angular

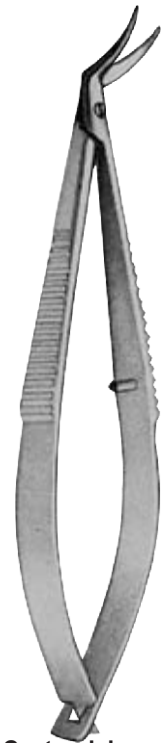

Castroviejo
Corneal Scissors,
21-3138-90 Right
21-3139-93 Left

Left Right
links rechts
links droit
Izquierda derecho

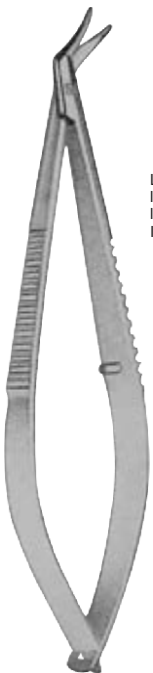

Left Right
links rechts
links droit
Izquierda derecho



Left Right
links rechts
links droit
Izquierda derecho



Left Right
links rechts
links droit
Izquierda derecho



Left Right
links rechts
links droit
Izquierda derecho

Castroviejo
Miniature Corneal Scissors,
21-3140-94 Right
21-3141-95 Left

Troutman Castroviejo
Micro Corneal Scissors,
21-3142-96 Right
21-3143-97 Left

Troutman Castroviejo
Micro Corneal Scissors,
with stop lock
21-3144-98 Right
21-3145-99 Left

Troutman Castroviejo
Comeosleral Scissors,
with stop lock
Medium Blades
21-3146-00 Right
21-3147-01 Left

Ophthalmology Instruments

Needle Holders
Nadelhalter

Porte-aiguilles
Porta Agujas

21



Arruga
Needle Holder
21-3148-02 Straight
21-3149-03 Curved

Straight gerade droit recto
Curved Gebogene courbé Curvo



Kalt
Needle Holder
21-3150-04 Straight
21-3151-05 Curved

Straight gerade droit recto
Curved Gebogene courbé Curvo



Castroviejo-Kalt
Needle Holder with Scissors
21-3152-06



Barraquer
Needle Holder Curved without Lock 5.5"
21-3153-07



Baby Barraquer
Needle Holder, Delicate
21-3154-A Straight with Lock
21-3155-B Straight without Lock
21-3156-A Curved with Lock
21-3157-B Curved without Lock

Straight with Lock
Gerade mit Schloss
Droit avec verrouillage
Recto con bloqueo

Straight without Lock
Gerade ohne Sperre
Droite sans serrure
Recto sin bloqueo

Curved with Lock
Gebogen mit Sperre
Courbé avec verrouillage
Curvo con cerradura

Curved without Lock
Gebogene ohne Lock
Courbé sans verrouillage
Curva sin bloqueo



Castroviejo
Needle Holder, Delicate
21-3158-A Straight with Lock
21-3159-B Straight without Lock
21-3160-A Curved with Lock
21-3161-B Curved without Lock

Straight with Lock
Gerade mit Schloss
Droit avec verrouillage
Recto con bloqueo

Straight without Lock
Gerade ohne Sperre
Droite sans serrure
Recto sin bloqueo

Curved with Lock
Gebogen mit Sperre
Courbé avec verrouillage
Curvo con cerradura

Curved without Lock
Gebogene ohne Lock
Courbé sans verrouillage
Curva sin bloqueo



Castroviejo
Needle Holder, Standard
21-3162-A Straight with Lock
21-3163-B Straight without Lock
21-3164-A Curved with Lock
21-3165-B Curved without Lock

Straight with Lock
Gerade mit Schloss
Droit avec verrouillage
Recto con bloqueo

Straight without Lock
Gerade ohne Sperre
Droite sans serrure
Recto sin bloqueo

Curved with Lock
Gebogen mit Sperre
Courbé avec verrouillage
Curvo con cerradura

Curved without Lock
Gebogene ohne Lock
Courbé sans verrouillage
Curva sin bloqueo

Ophthalmology Instruments

Needle Holders & Breakers
Nadelhalter & Breakers

Porte-aiguilles et disjoncteurs
Cajas de los interruptores automáticos



Stevens
Needle Holder, Straight
21-3166-A with Lock
21-3167-B without Lock
with lock without lock
mit Schloss ohne Schloss
avec serrure sans serrure
con cerradura sin cerradura



Mcpherson
Needle Holder
21-3168-A Straight with Lock
21-3168-B Straight without Lock
21-3169-A Curved with Lock
21-3169-B Curved without Lock

Straight with Lock
Gerade mit Schloss
Droit avec verrouillage
Recto con bloqueo

Straight without Lock
Gerade ohne Sperre
Droite sans serrure
Recto sin bloqueo

Curved with Lock
Gebogen mit Sperre
Courbé avec verrouillage
Curvo con cerradura

Curved without Lock
Gebogene ohne Lock
Courbé sans verrouillage
Curva sin bloqueo



Needle Holder
Very Delicate Jaws
21-3170-A Straight with Lock
21-3171-B Straight without Lock
21-3172-A Curved with Lock
21-3173-B Curved without Lock

Straight with Lock
Gerade mit Schloss
Droit avec verrouillage
Recto con bloqueo

Straight without Lock
Gerade ohne Sperre
Droite sans serrure
Recto sin bloqueo

Curved with Lock
Gebogen mit Sperre
Courbé avec verrouillage
Curvo con cerradura

Curved without Lock
Gebogene ohne Lock
Courbé sans verrouillage
Curva sin bloqueo



Castroviejo
Blade Breaker & Holder
21-3174-19



Castroviejo
Blade Breaker & Holder
Slim Model
21-3175-20 Slim
21-3176-21 12cm



Carbon Steel
Double Edged Blade
for Blade Breaker & holder
Box-100 Sterile
21-3177-22

Ophthalmology Instruments

Handle, Collects, Blades
Handle, sammelt, Blades

Poignée, Collecte, Blades
Mango, recoge, cuchillas

21



For Use with all
Blades Won Sterile
Zur Verwendung mit
allen Blades Won Sterile
Destiné à être utilisé avec
tous les Lames Stériles Won
Para uso con todos los
Hojas Won estéril

Chuck Handle
For Use with all
Blades Won Sterile
21-3178-02 2"
21-3178-03 3"
21-3178-04 4"
21-3178-06 6"
21-3178-4H 4"



Bard-Parker
Handle
21-3179-03 3"
21-3179-04 4"
21-3179-07 7"



Bard-Pariizer
Handle
21-3180-10 # 10
21-3180-11 # 11
21-3180-15 #15

Obsetetrics Instruments

Pelvimeter, Obsetetrics Forceps
Pelvimeter, Obsetetrics Zange

Pelvimètre, Obsetetrics Forceps
Pelvímetro, Obsetetrics Pinzas



De Lee
22-3182-20
20 cm/8"
cm/Inch Scale



Martin
22-3183-34 34 cm/13½" 22-3184-34
cm Scale cm/Inch Scale



Collin
22-3185-35
35 cm/13¾"
cm Scale



Breisky
22-3186-33
33 cm/13"
cm Inch Scale



Collyer
22-3187-30
30 cm/12"
cm Inch Scale

Obsetetrics Instruments

Obsetetrics Forceps
Obsetetrics Zange

Obsetetrics Forceps
Obsetetrics Pinzas



22



Nagele
22-3188-35
35 cm/13 3/4"



Simpson
22-3189-30
30 cm/12"



Wrigley
22-3190-30
28 cm/11"



Simpson-Braun
22-3191-36
36 cm/14"



Simpson-Luikert
22-3192-36
36 cm/14"



Kielland
22-3193-41
41 cm/16"

Obstetrics Instruments

Placents Ovum Forceps and Abortion Scoops
 Placents Ovum Zange und Abtreibung Scoops

Placents Ovum Forceps et l'avortement Scoops
 Placents Ovum Pinzas y primicias Aborto



Winter
 28 cm/11"

Straight
 gerade
 droit
 recto

22-3194-01

22-3195-01

22-3196-01

Curved
 Gebogene
 courbé
 Curvo

22-3194-02

22-3195-02

22-3196-02

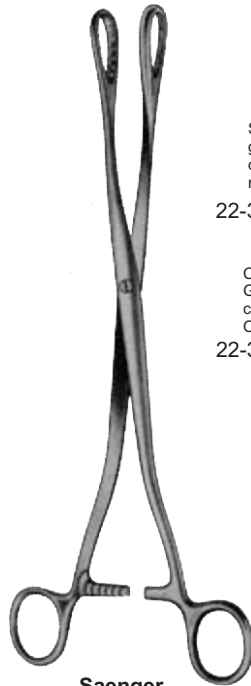

Saenger
 21 cm/10½"

Straight
 gerade
 droit
 recto

22-3197-27

Curved
 Gebogene
 courbé
 Curvo

22-3198-27

Uterine Haemostasis Forceps



Green-Armytage
 22-3199-21
 21 cm/8¼"

Obsetetrics Instruments

Scalp Flap Forceps, Perforators and Elevating Spoons
 Kopfhaut-Flap Zange, Locher und Hochlege
 Löffelchenstellung

Pince à lamelles cuir chevelu, Perforateurs et cuillères élevatrices
 Pinzas del cuero cabelludo Flap, perforadoras y
 Cucharas elevadoras



22

Scalp Flap Forceps



Willet-Martel
 22-3200-19
 19 cm/7½"



Gauss
 22-3201-26
 26 cm/10¼"



Head Lever

Murless
 22-3202-26
 26 cm/10¼"



Sellheim
 22-3203-28
 32 cm/12 ½"

Elevating Spoon
 Elevating Löffel
 élevant Spoon
 Elevar Spoon



Smellie
 22-3204-25
 25 cm/10"

Perforators
 Perforatoren
 perforateurs
 Perforadores



Nagele
 22-3205-25
 25 cm/10"

Obsetetrics Instruments

Cranioclast, Hook and Cord Clamps
 Cranioclast, Hook und Kabelklemmen

Pincas Cranioclast, crochet et cordon
 Cranioclast, gancho y el cable de pinzas

Basiotribe

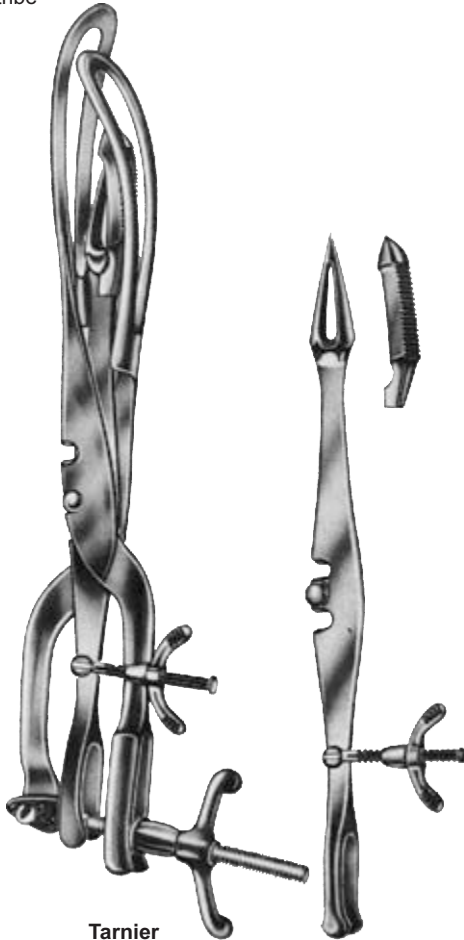

Tarnier
 22-3206-46
 46 cm/18"

Cranioclast



Braun
 22-3207-42
 42 cm/16 1/2"

Umbilical Cord Clamps
 Nabelschnur Schellen
 Colliers de cordon ombilical
 Abrazaderas del cordón umbilical



Collin
 22-3208-09
 9 cm/3 1/2"



Decapitating Hook
 Decapitating Haken
 Decapitating Crochet
 Decapitating Hook

Braun
 22-3209-30
 30 cm/12"

Otology Instruments

Micro Ear Forceps
Micro Ohrzängchen

Micro Ear Forceps
Micro Ear Forceps



23

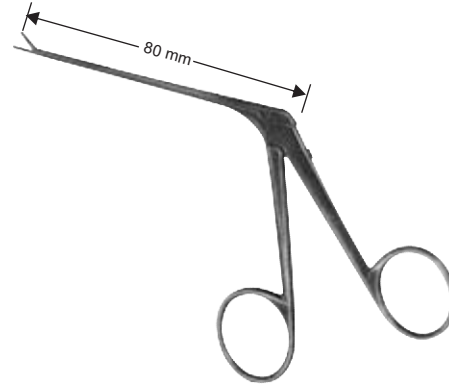
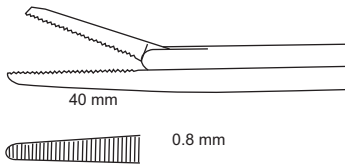
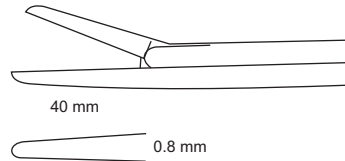

23-3210-01
4.0 x 08 mm
Smooth Straight
glattem
lissez droite
Alise Straight



23-3210-06
4.0 x 08 mm
Serrated Straight
Serrated Gerade
dentelée droite
dentado recto



23-3210-07
4.0 x 08 mm
Bent, upwards serrated
Bent, oben gezahnt
Bent, vers le haut en dents de scie
Bent, dentado hacia arriba



23-3210-08
4.0 x 08 mm
Right, searrated
Richtig, searrated
Droite, searrated
Derecha, searrated



23-3210-09
4.0 x 08 mm
Left, searrated
Links, searrated
Gauche, searrated
Izquierda, searrated

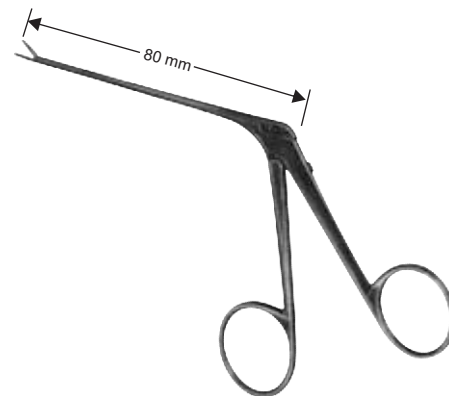
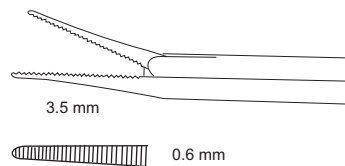
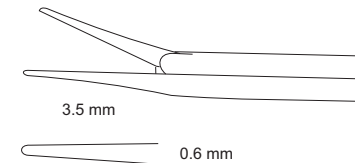

23-3211-11
3.3 x 06 mm
Smooth Straight
glattem
lissez droite
Alise Straight



23-3211-12
3.3 x 06 mm
Serrated Straight
Serrated Gerade
dentelée droite
dentado recto

Mini-McGee

Otology Instruments

Micro Ear Forceps
Micro Ohrzängchen

Micro Ear Forceps
Micro Ear Forceps

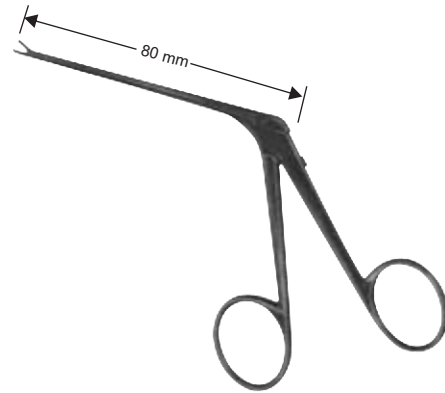
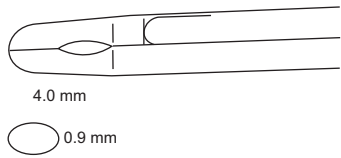

23-3212-01
4.0 mm
Straight
gerade
droit
recto



23-3212-02
4.0 mm
Bent, Upwards
Bent, Upwards
Bent, Vers le haut
Bent, Hacia arriba



23-3212-03
4.0 mm
Right
rechts
droit
derecho



23-3212-04
4.0 mm
Left
links
links
Izquierda

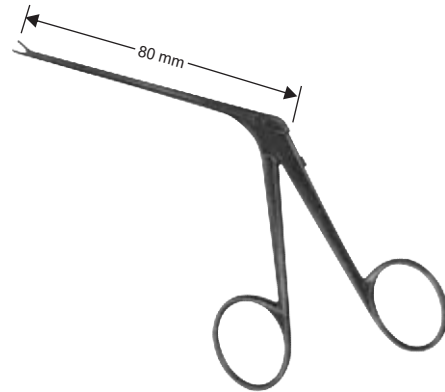
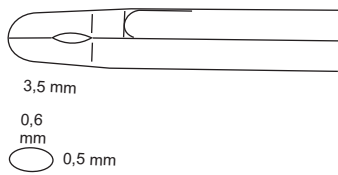

23-3213-11
3.5 mm
Straight
gerade
droit
recto



23-3213-12
3.5 mm
Bent, Upwards
Bent, Upwards
Bent, Vers le haut
Bent, Hacia arriba



23-3213-13
3.5 mm
Right
rechts
droit
derecho



23-3213-14
3.5 mm
Left
links
links
Izquierda

Otology Instruments

Micro Ear Scissor
Micro Ear Scissor

Scissor oreille Micro
Micro tijera oído

23

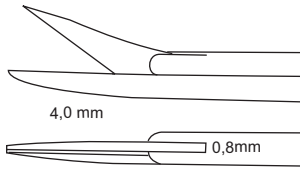

- | | | | |
|--------------------------------------|--|-------------------------------------|-------------------------------------|
| | | | |
| 23-3214-01 | 23-3214-02 | 23-3214-03 | 23-3214-04 |
| Straight
gerade
droit
recto | Bent, Upwards
Bent, Upwards
Bent, Vers le haut
Bent, Hacia arriba | Right
rechts
droit
derecho | Left
links
links
Izquierda |

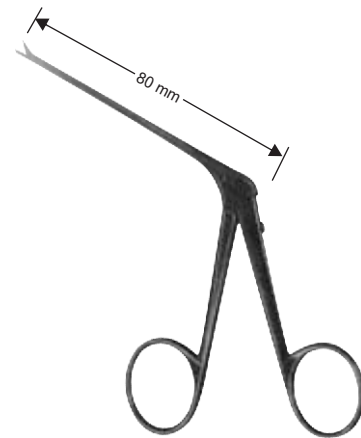

Bucci

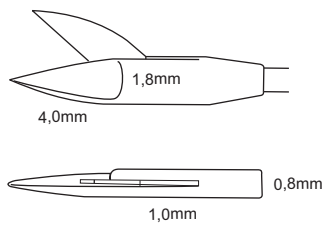

- | | | | |
|--------------------------------------|--|-------------------------------------|--|
| | | | |
| 23-3215-51 | 23-3215-52 | 23-3215-53 | |
| Straight
gerade
droit
recto | Bent, Upwards
Bent, Upwards
Bent, Vers le haut
Bent, Hacia arriba | Right
rechts
droit
derecho | |

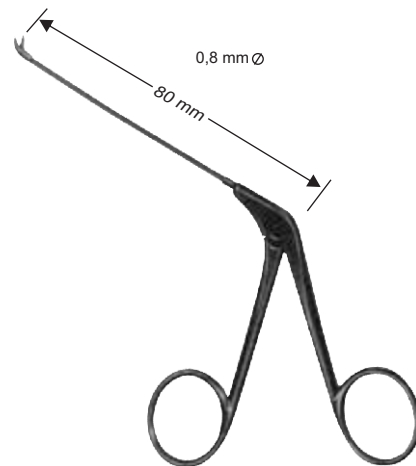

Wullstein

Otology Instruments

Micro Ear Forceps
Micro Ohrzängchen

Micro Ear Forceps
Micro Ear Forceps

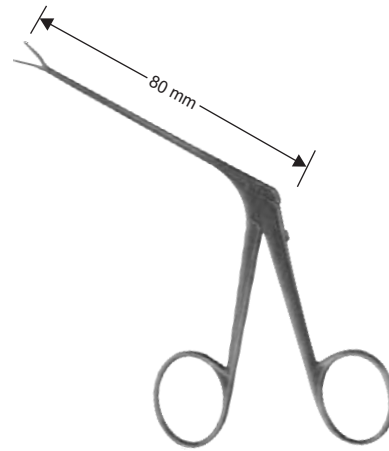
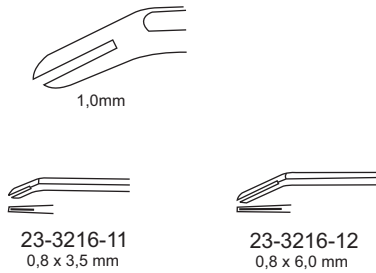

McGee

Wire Bending Forceps
Bent, Hacia arriba
Bent, hacia arriba
Bent, Hacia arriba

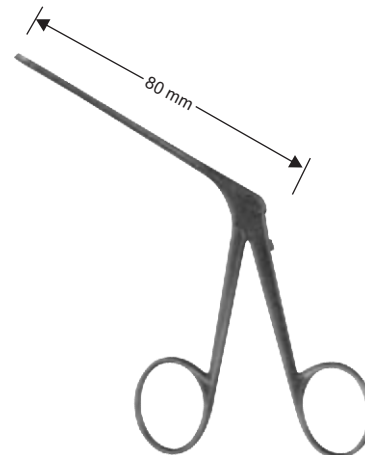
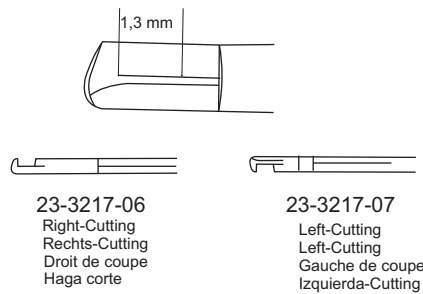

House-Dieter

Malleus Nipper
Malleus Nipper
Nipper Malleus

Otology Instruments

Micro Ear Knives
Micro Ear Messer

Couteaux oreille Micro
Cuchillos Micro oído



23

Messer

Knives



Schuknecht
23-3218-01



Schuknecht
23-3219-02



Schuknecht
23-3220-01



Wullstein
23-3221-01



Tabb
23-3222-01



Plester
23-3223-01



Plester
23-3224-02



23-3224-03



Rosen

23-3225-20
2.0 mm



23-3225-10
1.0 mm



23-3225-14
1.4 mm



23-3225-16
1.6 mm



23-3225-26
2.6 mm



23-3225-28
2.8 mm



23-3225-30
3.0 mm

Otology Instruments

Micro Ear Needls
Micro Ear Needls

Micro Ear Needls
Micro oído Needls

Needles And Hooks



Barbara
23-3226-01



23-3226-02



23-3226-03



Rosen
23-3226-04



Barbara



25°
23-3227-03 0.3 mm
23-3227-06 0.6 mm
23-3227-10 1.0 mm



45°
23-3228-03 0.3 mm
23-3228-06 0.6 mm
23-3228-10 1.0 mm
23-3228-12 1.2 mm
23-3228-15 1.5 mm
23-3228-20 2.0 mm
23-3228-25 2.5 mm



90°
23-3229-03 0.3 mm
23-3229-06 0.6 mm
23-3229-10 1.0 mm
23-3229-12 1.2 mm
23-3229-15 1.5 mm
23-3229-20 2.0 mm
23-3229-25 2.5 mm



23-3230-05 0.5 mm
23-3230-10 1.0 mm

Otology Instruments

Micro Ear Hooks, Micro Ear Needls
Micro Ohrbügel, Micro Ear Needls

Micro Ear Hooks, Micro Ear Needls
Micro Ear Hooks, Micro Ear Needls



23



90°

15.5 cm/6"

23-3231-03 0.3 mm
23-3231-06 0.6 mm
23-3231-10 1.0 mm



90°

15.5 cm/6"

23-3232-03 0.3 mm
23-3232-06 0.6 mm
23-3232-10 1.0 mm



McGee

15.5 cm/6"

23-3233-05 0.5 mm
23-3233-10 1.0 mm



McGee

15.5 cm/6"

23-3234-05 0.5 mm
23-3234-10 1.0 mm



Barbara
23-3235-01
15.5 cm/6"



Barbara
23-3235-02
15.5 cm/6"

Otology Instruments

Micro Ear Hooks
Micro Ear Hooks

Micro Ear Hooks
Micro Ear Hooks

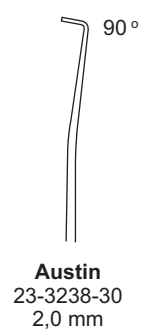
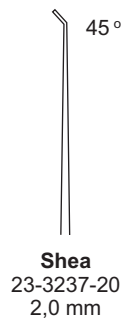
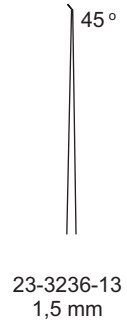
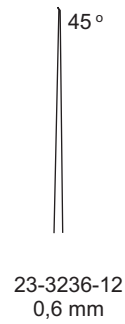
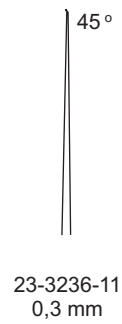
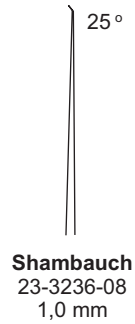

Otology Instruments

Micro Dissector and Micro Curetts
Mikrodissektor und Micro Kuretten

Micro Dissecteur et Micro Curetts
Micro disector y Curetts Micro



23

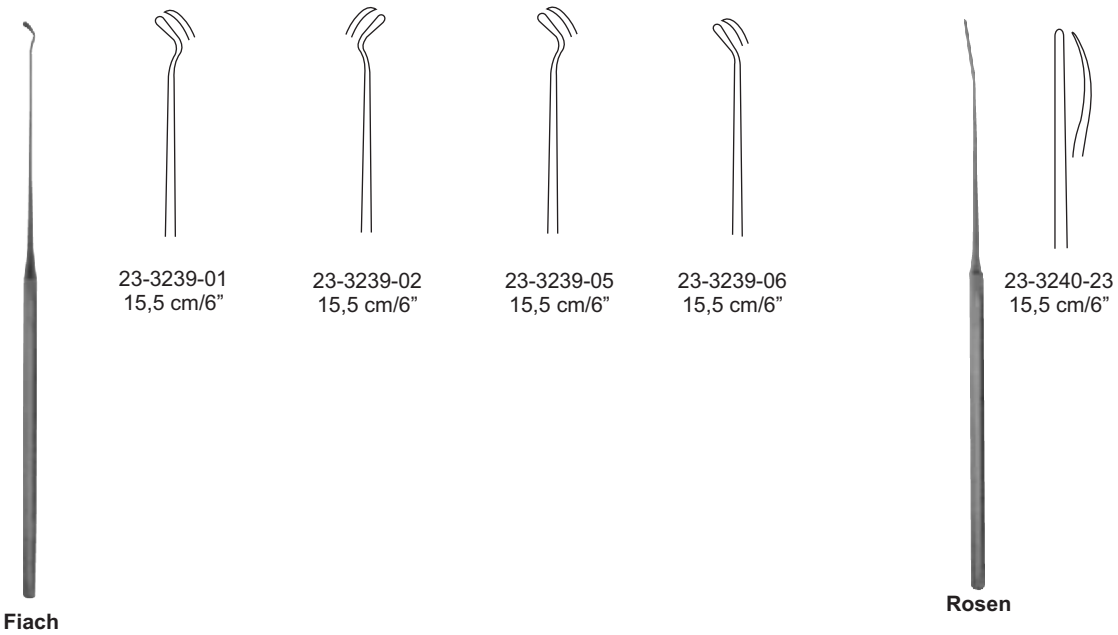

Fiach

Rosen

23-3239-01
15,5 cm/6"

23-3239-02
15,5 cm/6"

23-3239-05
15,5 cm/6"

23-3239-06
15,5 cm/6"

23-3240-23
15,5 cm/6"

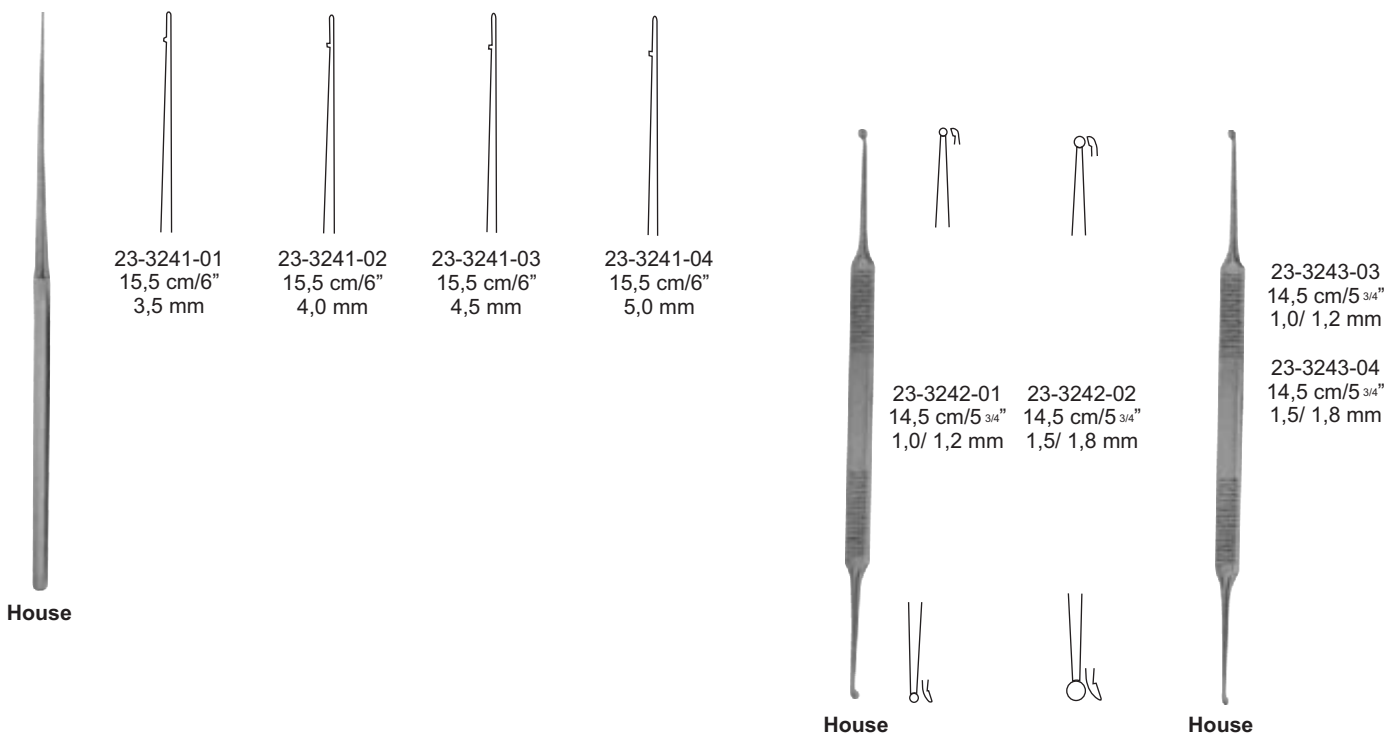

House

House

House

23-3241-01
15,5 cm/6"
3,5 mm

23-3241-02
15,5 cm/6"
4,0 mm

23-3241-03
15,5 cm/6"
4,5 mm

23-3241-04
15,5 cm/6"
5,0 mm

23-3242-01
14,5 cm/5 3/4"
1,0/ 1,2 mm

23-3242-02
14,5 cm/5 3/4"
1,5/ 1,8 mm

23-3243-03
14,5 cm/5 3/4"
1,0/ 1,2 mm

23-3243-04
14,5 cm/5 3/4"
1,5/ 1,8 mm

Otology Instruments

Ear Specula
Ohrtrichter

oreille spéculer
espéculos



Hartmann
For Children
für Kinder
pour les enfants
Para los niños

0 3,0 mm ø

23-3244-10
3,6 cm/1½"
Fig,0

1 4,0 mm ø

23-3244-11
3,6 cm/1½"
Fig,1

2 5,0 mm ø

23-3244-12
3,6 cm/1½"
Fig,2

1 4,0 mm ø

23-3245-11
3,6 cm/1½"
Fig,1

2 5,0 mm ø

23-3245-12
3,6 cm/1½"
Fig,2

3 6,0 mm ø

23-3245-13
3,6 cm/1½"
Fig,3

3 7,5 mm ø

23-3245-14
3,6 cm/1½"
Fig,4



Hartmann
For Adults
für Erwachsene
pour adultes
Para adultos

1 4,0 mm ø

23-3246-11
3,6 cm/1½"
Fig,1

2 5,0 mm ø

23-3246-12
3,6 cm/1½"
Fig,2

3 6,0 mm ø

23-3246-13
3,6 cm/1½"
Fig,3

4 7,5 mm ø

23-3246-14
3,6 cm/1½"
Fig,4



Toynbee
For Adults
für Erwachsene
pour adultes
Para adultos

Otology Instruments

Ear Specula
Ohrtrichter

oreille spéculer
espéculos

23



Zollner
Oval, Black
Oval, Schwarz
Ovale, Noir
Oval, Negro

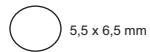

23-3247-01
3,8 cm/1½"
Fig,1

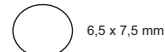

23-3247-02
3,8 cm/1½"
Fig,2

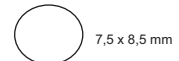

23-3247-03
3,8 cm/1½"
Fig,3

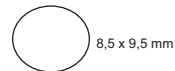

23-3247-04
3,8 cm/1½"
Fig,4

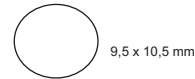

23-3247-05
3,8 cm/1½"
Fig,5



23-3247-06
3,8 cm/1½"
Fig,6



Farrior
Black
Schwarz
Noir
Negro



23-3248-01
3,6 cm/1½"
Fig,1

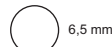

23-3248-02
3,6 cm/1½"
Fig,2



23-3248-03
3,6 cm/1½"
Fig,3

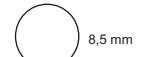

23-3248-04
3,6 cm/1½"
Fig,4



23-3248-05
3,6 cm/1½"
Fig,5



23-3248-06
3,6 cm/1½"
Fig,6



23-3248-07
3,6 cm/1½"
Fig,7

Otology Instruments

Tuning Forks
Stimmgabeln

Diapasons
Diapasones



French
23-3249-07

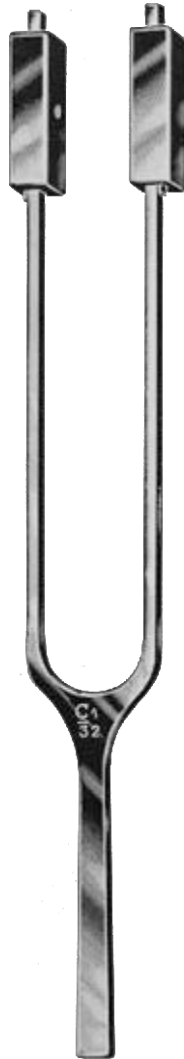

French
23-3250-08

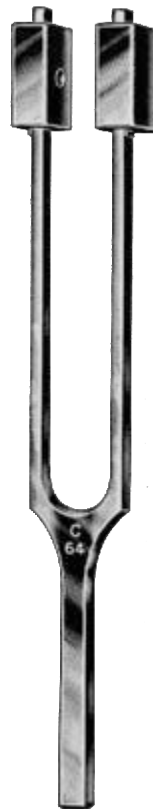

Hartmann
23-3251-09



Hartmann
23-3252-10



Hartmann
23-3253-10

Otology Instruments

Tuning Forks
Stimmgabeln

Diapasons
Diapasones



23

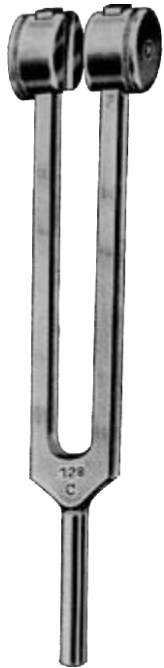

23-3254-10
C128



23-3255-11
C256

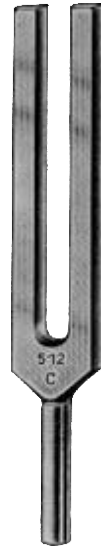

23-3256-12
C512



23-3257-13
C1024



23-3258-14
C2048

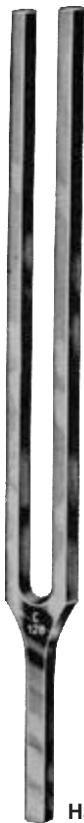

Hartmann
23-3259-10
C128



Hartmann
23-3260-11
C256



Lucae
23-3261-10
C128



Lucae
23-3262-14
C256

Otology Instruments

Tuning Forks
Stimmgabeln

Diapasons
Diapasones



Lucae
23-3263-10
C 128



Hartmann
23-3264-10
C 128



Rydel-Seiffert
23-3265-10
C 64/c 128



with hammer pinwheel,
brush and needle
mit Hammer pinwheel,
Pinsel und Nadel
moulinet avec un marteau,
pinceau et aiguille
con martillo molinete,
pincel y aguja

Neuro
23-3266-00
C 64/c 128



Movable up to g
Bewegbare bis g
Déplacer vers le haut à g
Muebles hasta g

Konig
23-3267-59
A 109

Otology Instruments

Ear Catheters, Polypus Snares
Ohr-Katheter, Polypen Snares

Cathéters oreille, Polypus Snares
Los catéteres de oído, Pólipos Snares



23



Hartmann

23-3268-01
15 cm / 6"
Fig.1

23-3268-02
15 cm / 6"
Fig.2

23-3268-03
15 cm / 6"
Fig.3



23-3269-30
0,3 mm \varnothing

23-3269-40
0,4 mm \varnothing



Krause

23-3270-16
18,5 cm / 7 1/4"
Open Tip
Open Tip
Astuce ouvert
Consejo Open



Krause-Voss

23-3271-16
18,5 cm / 7 1/4"
Closed Tip2
Closed Tip2
fermé Astuce2
Cerrado Tip2

Otology Instruments

Ear Forceps
Ohrzängchen

Pince oreille
Pinzas del oído



Troeltsch (Wilde)
23-3272-10
10,5 cm / 4 1/8"



Troeltsch (Wilde)
23-3273-10
11,5 cm / 4 3/4"

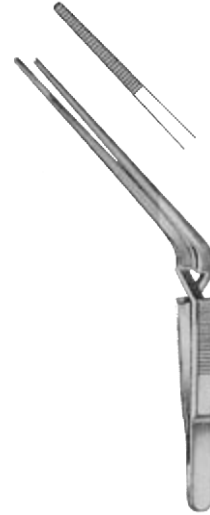

Troeltsch (Wilde)
23-3274-13
12,5 cm / 5"

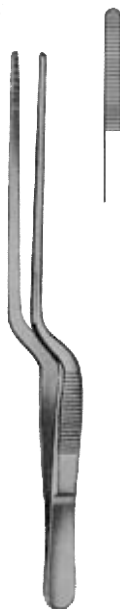

Crunwald
23-3275-14
12,5 cm / 5 1/8"



Jansen
23-3276-16
12,5 cm / 5 1/8"

Otology Instruments

Ear Polypus Forceps
Ohr-Tupfer-Zange

Oreille Polypus Forceps
Pólipos del oído Pinzas



23



Lettau
23-3277-10
10 cm / 4"



Hartmann
23-3278-12
12 cm / 4 3/4"
Fine Mode
Modèle fin
modelo Fine



Hartmann
23-3279-14
14 cm / 5 1/2"
Fine Mode
Modèle fin
modelo Fine



Buck
23-3280-11
11.5 cm / 4 1/2"
Foreign Body Forceps
Fremdkörperzange
Pince à corps étrangers
Pinzas de cuerpos extraños

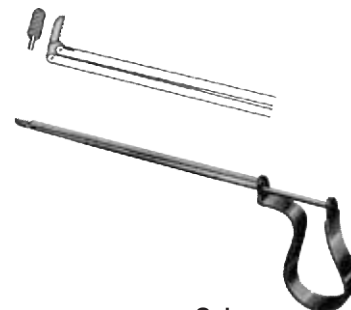

Quire
23-3281-10
10.5 cm / 4"
Foreign Body Lever
Foreign Body Lever
Levier de corps étrangers
Palanca de cuerpo extraño

Otology Instruments

Ear Polypus Forceps
Ohr-Tupfer-Zange

Oreille Polypus Forceps
Pólipos del oído Pinzas



23-3282-08 - 23-3283-08



Hartmann-Wullstein
23-3284-08
8,5 cm / 3 1/2"



Hartmann-Wullstein
23-3285-08
8,5 cm / 3 1/2"



Hartmann
23-3286-08 = 8,5 cm / 3 1/2"
23-3286-14 = 14 cm / 5 1/2"
23-3286-16,5 = 16,5 cm / 6 1/2"



Hartmann
23-3287-08 = 8,5 cm / 3 1/2"



Hartmann Noyes
23-3288-09 = 9 cm / 3 1/2"



Hartmann Noyes
23-3289-09 = 9 cm / 3 1/2"



Hartmann Weingartner
23-3290-08 = 8,5 cm / 3 1/2"



Hartmann
23-3291-08 = 8,5 cm / 3 1/2"

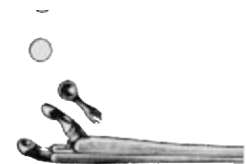

Hartmann
23-3292-81 = 2 mm \varnothing
23-3292-82 = 2,5 mm \varnothing
23-3292-83 = 3mm \varnothing



Hartmann
23-3293-08
8,5 cm / 3 1/2"



Struempel
23-3294-08
8,5 cm / 3 1/2"



Hartmann-Hoffmann
23-3295-08
8,5 cm / 3 1/2"

Otology Instruments

Mastoid Rongeurs
Warzenfortsatz Rongeur

Rongeurs mastoïdiennes
Los roedores mastoides

23



Citelli
23-3296-17
3 mm cut



Citelli-Beyer
23-3297-19
2 mm cut



Width of Bite



Brunings
23-3298-40
23-3298-60

-  23-3299-30 3.0 mm
-  23-3299-40 4.0 mm
-  23-3299-50 5.0 mm
-  23-3299-60 6.0 mm



Kerrison
20 cm/8"



Otology Instruments
 Ear Currettes Curettes auriculaires
 Ohr-Küretten Curetas del oído

23



Buck
 23-3306 - 23-3306-14
 16,5 cm/6 1/2"

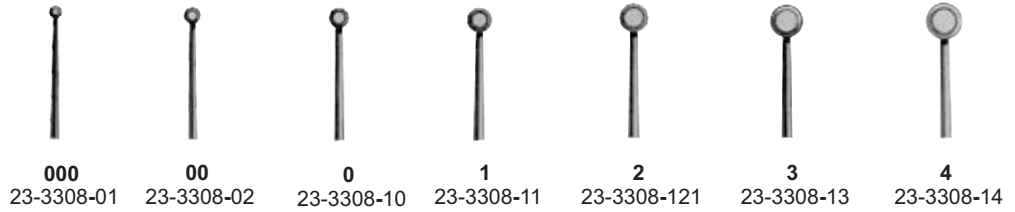
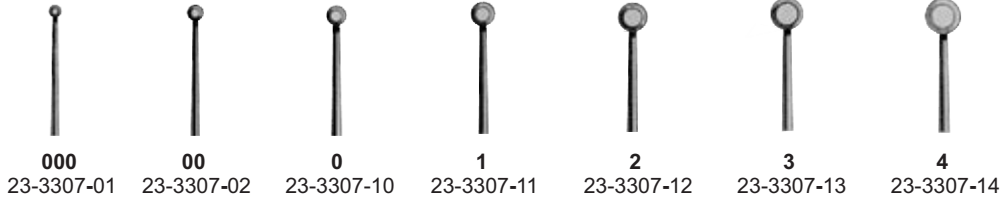

Jansen
 23-3309-15
 16,5 cm/6 1/2"
 Sharp
 scharf
 net
 agudo



Jansen
 23-3310-15
 18 cm/7 1/4"
 Sharp
 scharf
 net
 agudo



Otology Instruments

Ear Curettes
Ohr-Küretten

Curettes auriculaires
Curetas del oído



SEGITECH

23



23-3301-08
13 cm/5"

Langenbeck
23-3300-13
13 cm/ 5 1/4"



Shapleigh
23-3302-13
13 cm/ 5 1/4"



23-3302-01



23-3302-02



23-3302-03



23-3302-04



Buck
23-3303-01
16,5 cm/ 6 1/2"



Blunt



000
23-3304-01



00
23-3304-02



0
23-3304-10



1
23-3304-11



2
23-3304-12



Sharp
scharf
net
agudo



000
23-3305-01



00
23-3305-02



0
23-3305-10



1
23-3305-11



2
23-3305-12

Otology Instruments

Foreign Body Instruments
Foreign Body Instruments

Instruments de corps étrangers
Instrumentos de cuerpo extraño



23-3311-01
16,5 cm/6 1/2"

Weber-Lock
Ear Loop
Ohrbügel
boucle d'oreille
Ear Loop

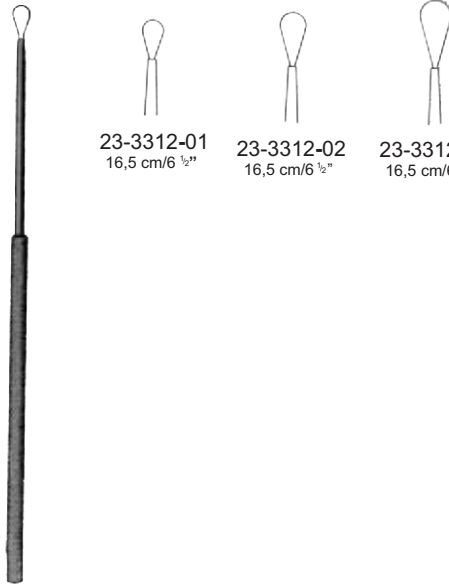

23-3312-01
16,5 cm/6 1/2"

23-3312-02
16,5 cm/6 1/2"

23-3312-03
16,5 cm/6 1/2"

Billeau
Ear Loop
Ohrbügel
boucle d'oreille
Ear Loop



23-3313-16
15,5 cm/6 "

1/2

Moldenhauer
Foreign Body Lever
Foreign Body Lever
Levier de corps étrangers
Palanca de cuerpo extraño



23-3314-16
15 cm/6 "

Zaufal
Foreign Body Lever
Foreign Body Lever
Levier de corps étrangers
Palanca de cuerpo extraño



23-3315-16
16 cm/6 1/2"

Hartmann
Ear Hooks

Otology Instruments

Ear Hooklets
Ear Hakchen

petits crochets d'oreille
ganchillos del oido



23

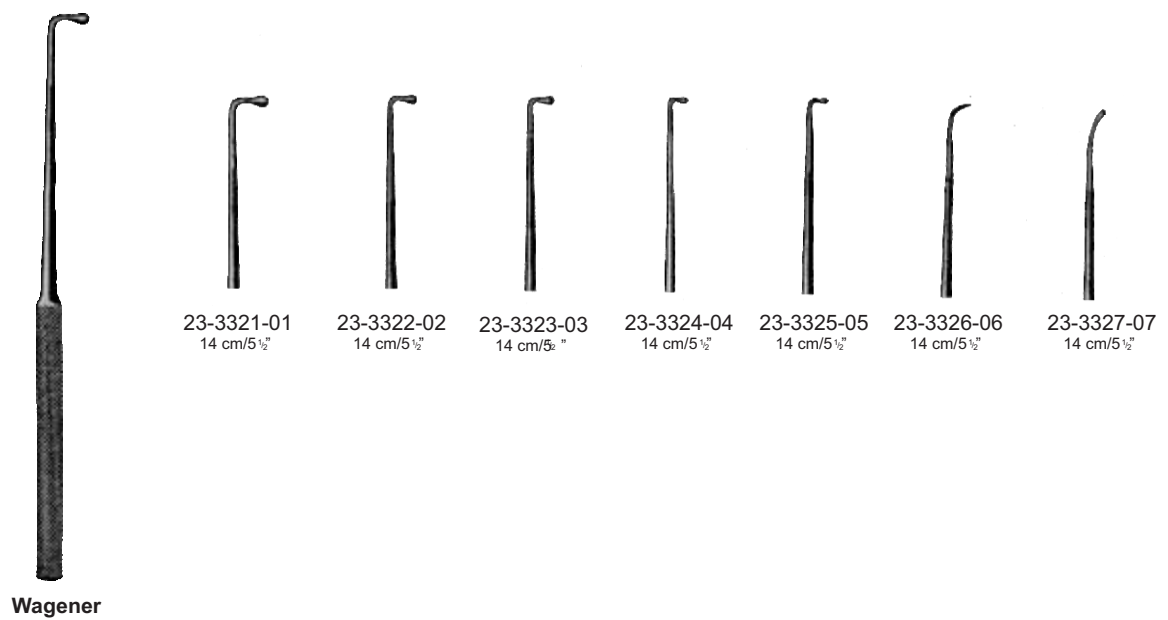
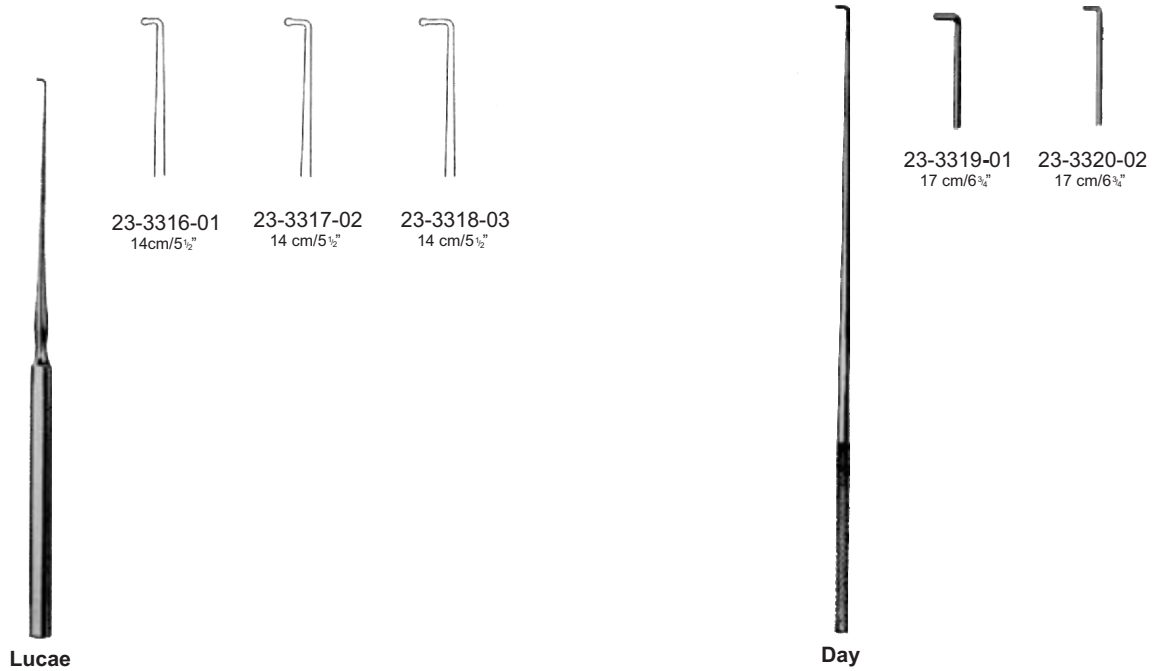

Otology Instruments

Tympanum Needles
Tympanon Needles

Aiguilles tympan
Agujas tímpano



Poltzer
23-3328-16
16 cm/6 1/2"



Buck
23-3329-15
15 cm/6"



Sexton
23-3330-18
18 cm/7 1/4"



Poltzer
23-3331-16
16 cm/6 1/2"



Poltzer
23-3332-16
16,5 cm/6 1/2"

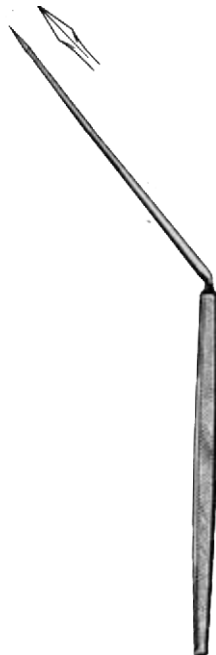

Poltzer
23-3333-16
16,5 cm/6 1/2"



Lucae
23-3334-18
18 cm/7 1/4"



Lucae
23-3335-18
18 cm/7 1/4"

Otology Instruments

Ear Periosteal Elevators, Ear Scoops
 Ear Raspatorien, Ohrstäbchen

Ear rugines, oreille Scoops
 Oído periostio Elevadores, oído Scoops



23



23-3338-16 2 mm 23-3339-16 2 mm 23-3340-15 3 mm

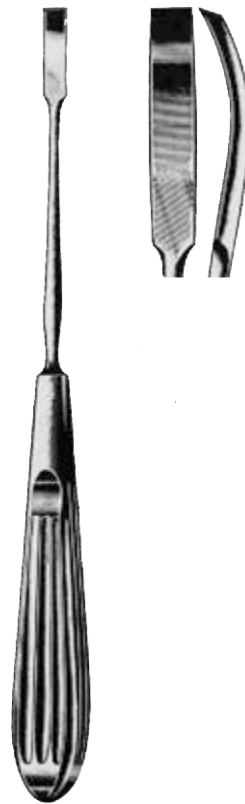

Lempert
 23-3341-16
 20,5 cm/5 1/4"

Lempert
 23-3336-16 - 23-3337-15
 19 cm/7 1/2"



Lempert
 23-3342-18
 18 cm/7 1/8"



Lempert
 23-3343-10 - 23-3343-50
 17,5 cm/7"

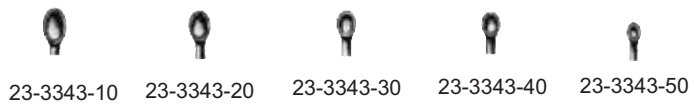

23-3343-10 23-3343-20 23-3343-30 23-3343-40 23-3343-50

Otology Instruments

Ear Syringes
Ohr-Spritzen

seringues pour les oreilles
Jeringas oído



23-3344-10



23-3344-20



23-3345-30

Ear Syringe, Complete With 2 Cannulas and 1Protecting Disk

23-3344-02	50 ml
23-3344-03	75 ml
23-3344-04	100 ml
23-3344-06	150 ml
23-3344-08	200 ml

Rhinology Instruments

Nasal Specula
Nasenspekula

nasale spéculer
Espécule nasal



24



24-3346-01
6,5 cm/2 1/2"
Fig.1



24-3346-02
6,5 cm/2 1/2"
Fig.2

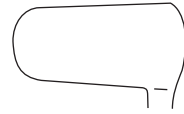

24-3346-03
6,5 cm/2 1/2"
Fig.3



24-3347-01



24-3347-02

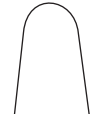

24-3347-03



Goldsmith (Thudichum)



Voltolini



Hartmann-Halle



24-3348-01
15,5 cm/6"
Fig.1

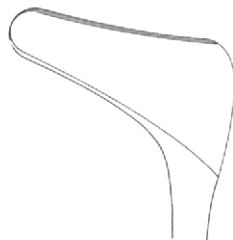

24-3348-02
15,5 cm/6"
Fig.1



24-3348-03
15,5 cm/6"
Fig.1

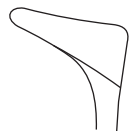

24-3349-13
13 cm/5"



Rhinology Instruments

Nasal Specula
Nasenspekula

nasale spéculer
Espéculo nasal

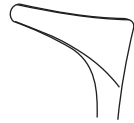

24-3350-13
1,5 cm/5"

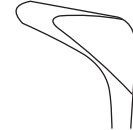

24-3351-13
13 cm/5"

Tieck-Halle



Killian

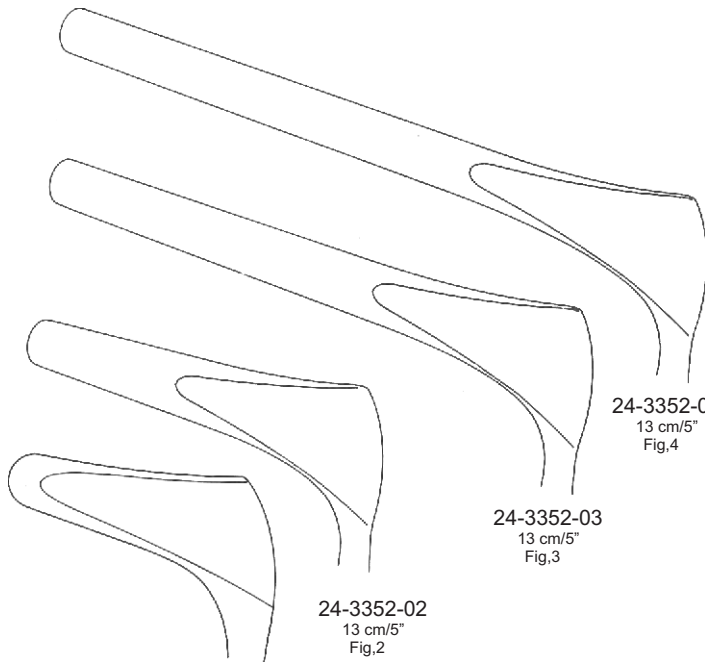

24-3352-01
13 cm/5"
Fig.1

24-3352-02
13 cm/5"
Fig.2

24-3352-03
13 cm/5"
Fig.3

24-3352-04
13 cm/5"
Fig.4



Model-Wien

24-3353-14
12,5 cm/5 1/4"
Fig.4

Rhinology Instruments

Nasal Specula
Nasenspekula

nasale spéculer
Espéculo nasal



24



Clittle

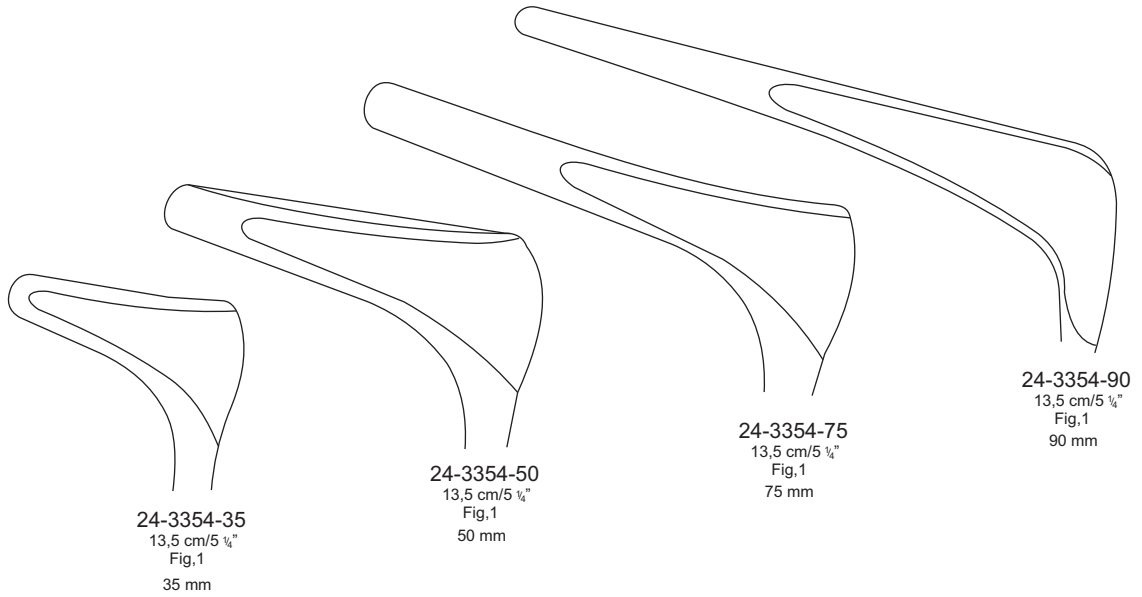

24-3354-35
13,5 cm/5 1/4"
Fig.1
35 mm

24-3354-50
13,5 cm/5 1/4"
Fig.1
50 mm

24-3354-75
13,5 cm/5 1/4"
Fig.1
75 mm

24-3354-90
13,5 cm/5 1/4"
Fig.1
90 mm



Clittle

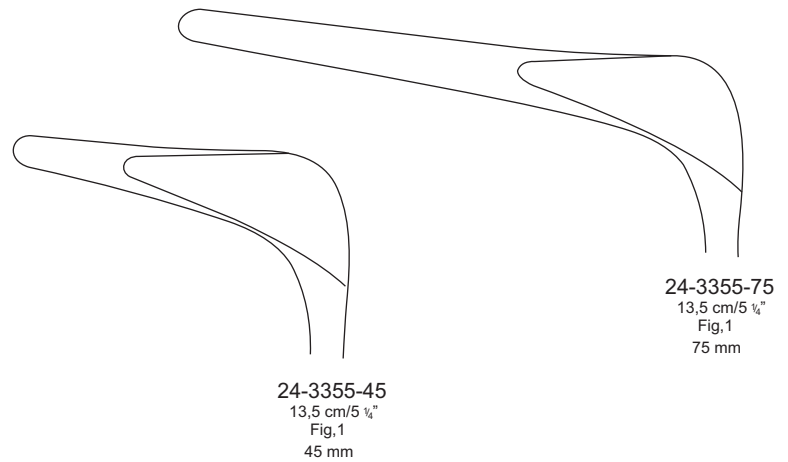

24-3355-45
13,5 cm/5 1/4"
Fig.1
45 mm

24-3355-75
13,5 cm/5 1/4"
Fig.1
75 mm

Rhinology Instruments

Polypus Snares
Polypus Snares

Polypus Snares
pólipos Snares

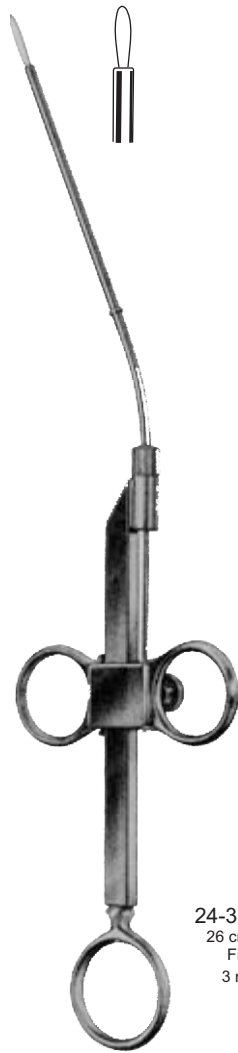

24-3356-26
26 cm/10 1/4"
Fig.1
3 mm Ø

Krause



24-3357-26
26 cm/10 1/4"
Fig.1
3 mm Ø

Krause-Voss



24-3358-10
10,5 cm/4 1/4"
0,3 mm Ø

Rhinology Instruments

Nasal Tempon Forceps
Nasal Tempon Zange

Nasale Tempon Forceps
Pinza nasal Tempon



24



Troltsch
24-3359-15
14,5 cm/5 3/4"



Troltsch
24-3360-15
18 cm/7"



Grunwald (Jansen)
24-3361-20
21,5 cm/8 1/2"

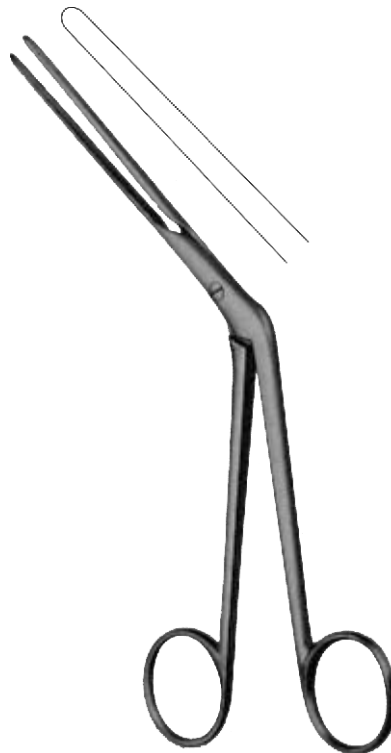

Lubet-Barbon
24-3362-20
18,5 cm/7 1/4"

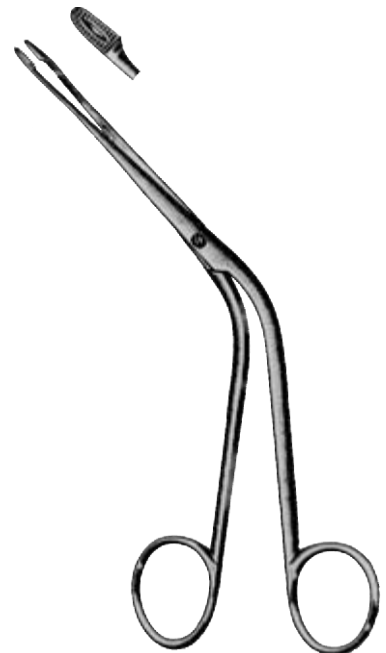

Hartmann
24-3363-15
15 cm/6 "

Rhinology Instruments

Nasal Polypus Forceps, Septum Forceps
Nasenpolypen Pinzetten, Zangen Septum

Nasale Polypus, forceps septum
Pólipos nasales Pinzas, Pinzas Septum

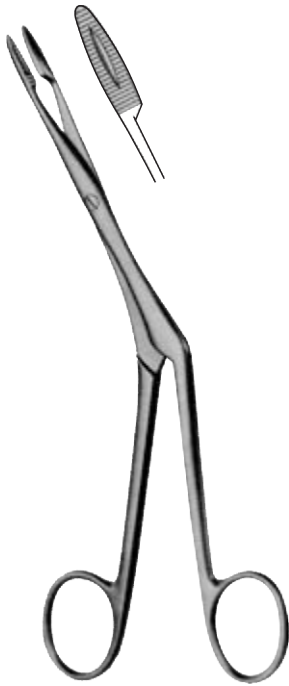

Hartmann
24-3364-20
18,5 cm/7 ¼"

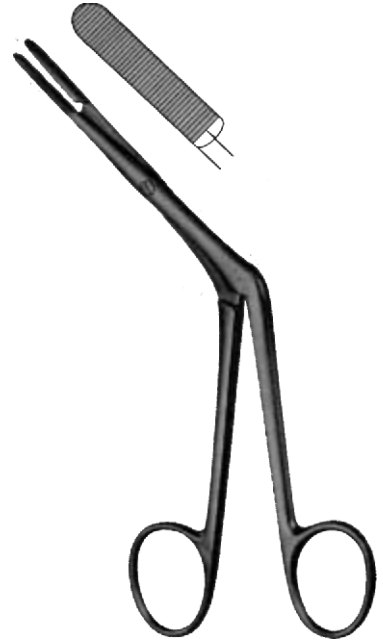

Killian
24-3365-17
16 cm/6 ¼"

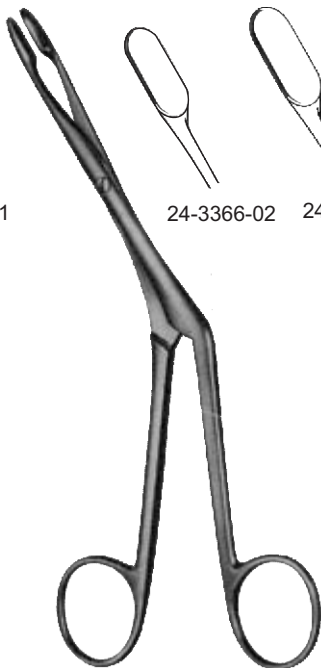

Heymann
24-3366-18
18 cm/7 "



Knight
24-3367-18
17 cm/6 ¾"

Rhinology Instruments

Septum Forceps, Ethmoid Bone Forceps
Septum Forceps, Ethmoid Knochenzange

Pince septum, pince à os Ethmoid
Pinzas, Pinzas Septum Ethmoid hueso



24



24-3368-01
16 cm/6 1/4"



24-3368-02
16 cm/6 1/4"



24-3369-01

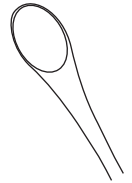

24-3369-02

Luc
24-3369-20
20 cm/8"

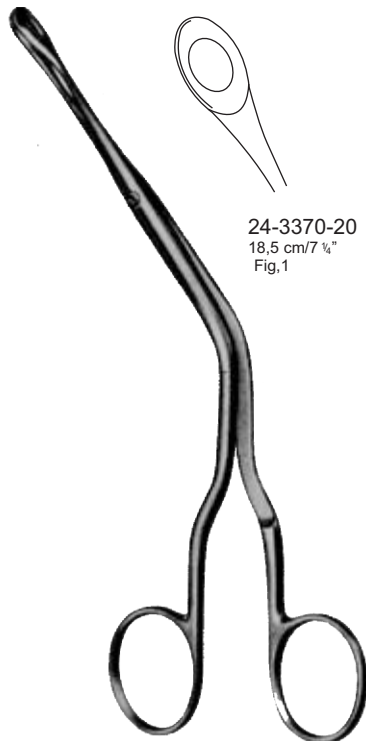

24-3370-20
18,5 cm/7 1/4"
Fig.1

Luc



24-3371-01
16,5 cm/6 1/2"
Fig.1



24-3371-02
16,5 cm/6 1/2"
Fig.2



24-3371-03
16,5 cm/6 1/2"
Fig.3



24-3371-04
16,5 cm/6 1/2"
Fig.4



Brunings

Rhinology Instruments

Ethmoid Bone Forceps
Ethmoid Knochenzange

Ethmoid daviers
Ethmoid hueso Pinzas

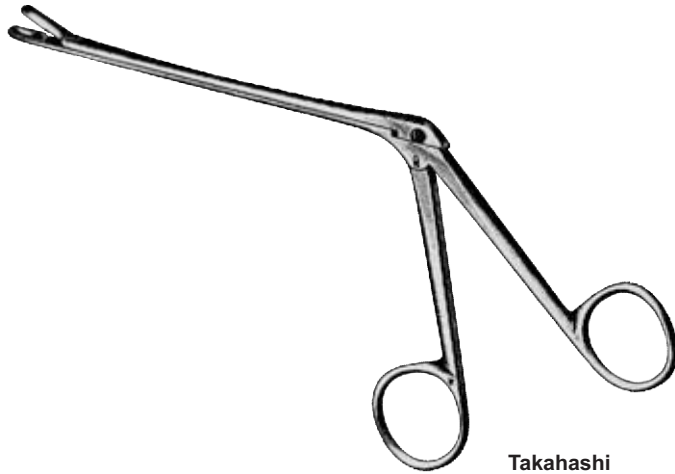

Takahashi

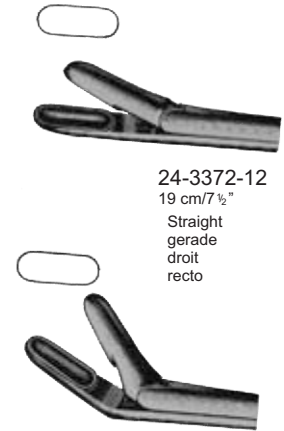

24-3372-12
19 cm/7 1/2"
Straight
gerade
droit
recto

24-3373-12
19 cm/7 1/2"
Bent Upwards
Bent Upwards
Bent Vers le haut
Bent Hacia arriba

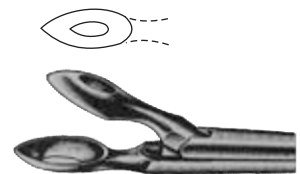
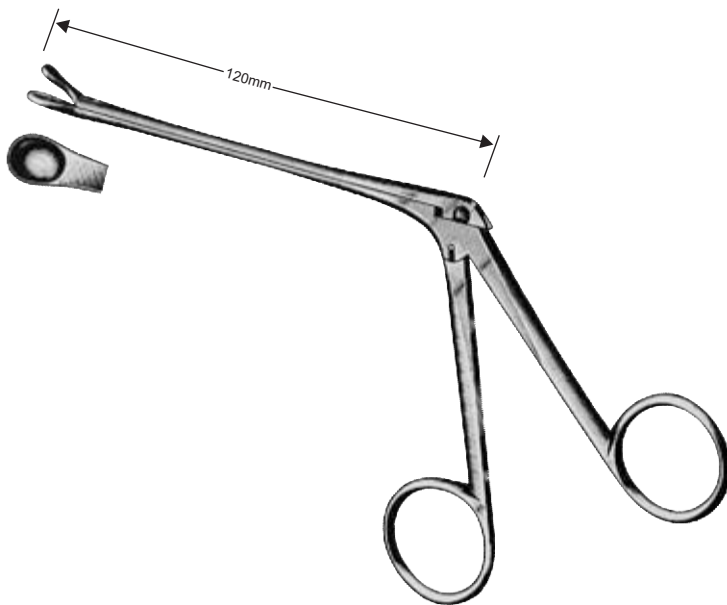

Weil
24-3374-12
12 cm/4 3/4"
with neck
mit Hals
avec col
con cuello



Watson-Williams
24-3375-12
19 cm/7 1/2"

Rhinology Instruments

Ethmoid Bone Forceps, Nasal Cutting Forceps
 Ethmoid Knochenzange, Nasal Cutting Forceps

Daviers Ethmoid, les nasaux Forceps coupe
 Ethmoid Pinzas de hueso, nasales Forceps de corte



24

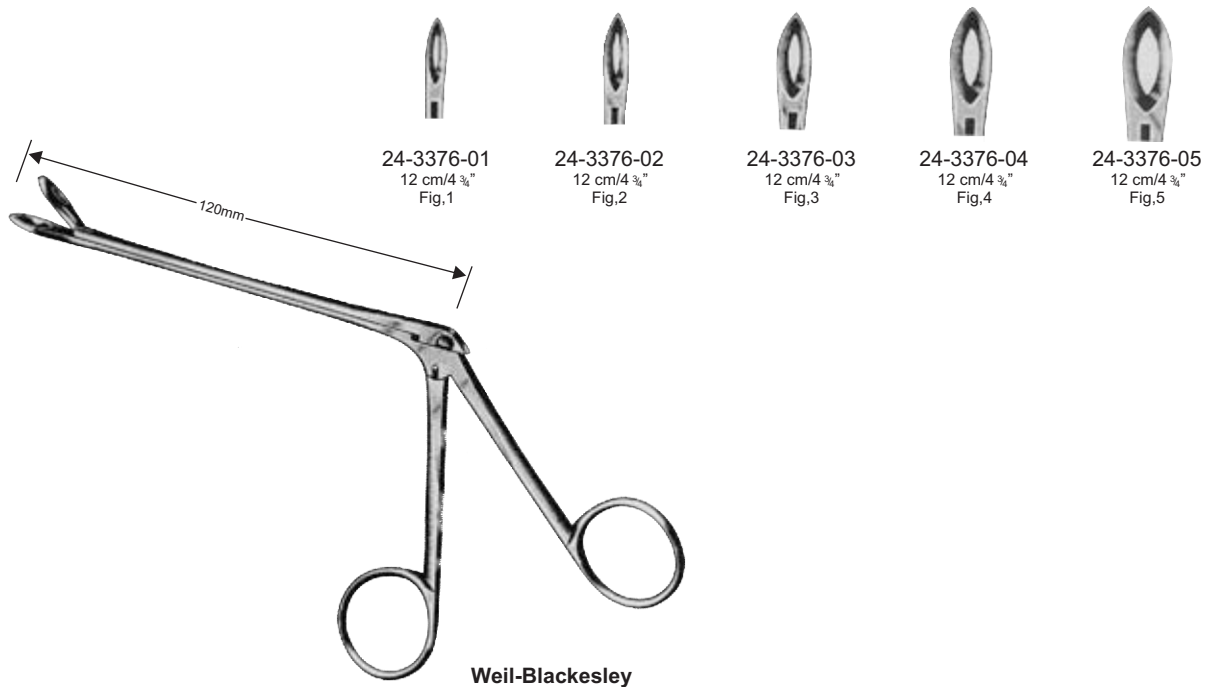

Weil-Blackesley

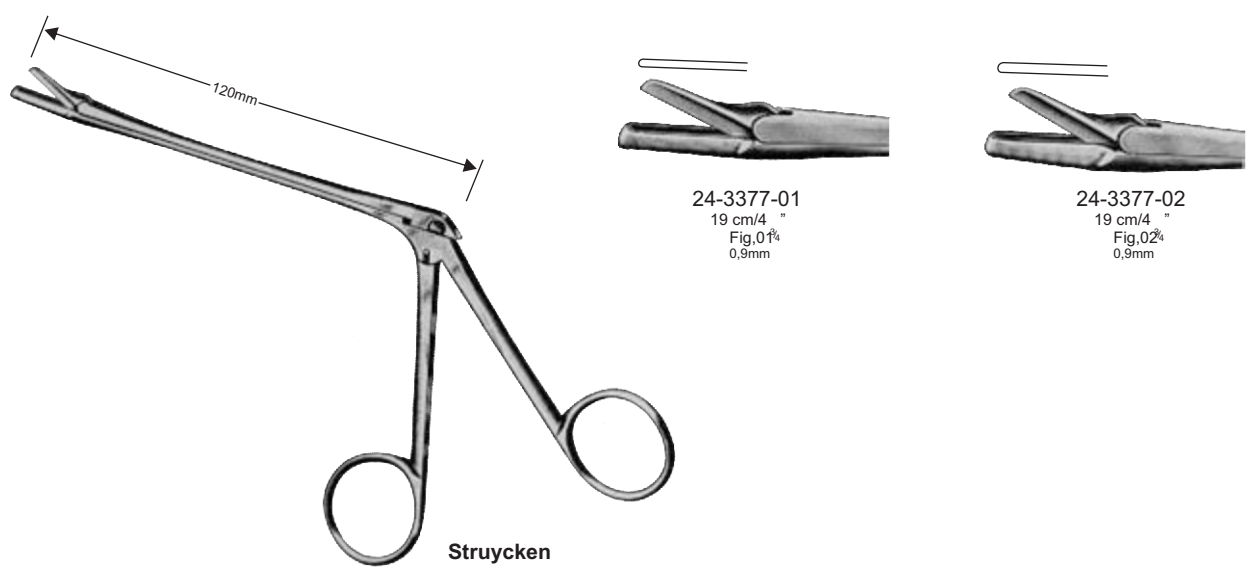

Struycken

Rhinology Instruments

Sphenoid Bone Punches
Keilbein Punches

Poiçons os sphénoïde
Punzones de hueso esfenoïdes



Middleton-Jansen
24-3378-19
19 cm/7½"



Middleton-Jansen
24-3379-19
19 cm/7½"



Kazanjian
24-3380-18
18 cm/7"

Rhinology Instruments

Sphenoid Bone Punches
Keilbein Punches

Poinçons os sphénoïde
Punzones de hueso esfenoides



24

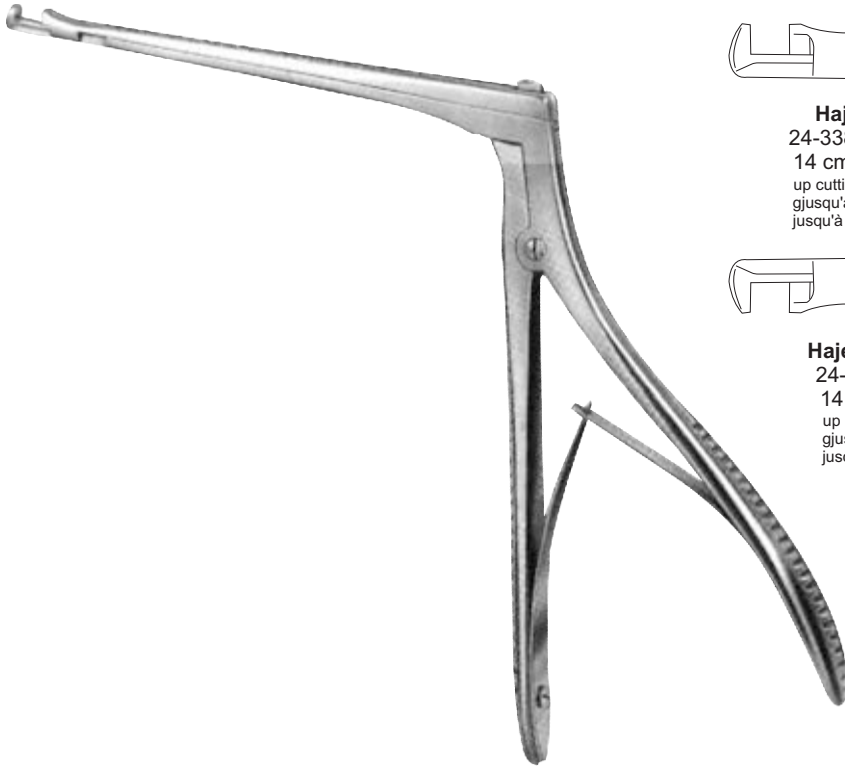

Hajek
24-3381-13
14 cm/5 1/2"
up cuttin
gjusqu'à la coupe
jusqu'à la coupe...



Hajek-Kofler
24-3383-12
14 cm/5 1/2"
up cuttin
gjusqu'à la coupe
jusqu'à la coupe...

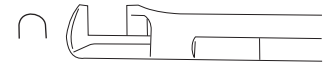

Hajek
24-3382-18
14 cm/5 1/2"
down cutting
unten schneiden
à coupe descendante
tala



Hajek-Kofler
24-3384-12
14 cm/5 1/2"
down cutting
unten schneiden
à coupe descendante
tala

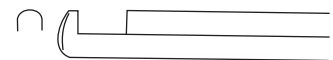
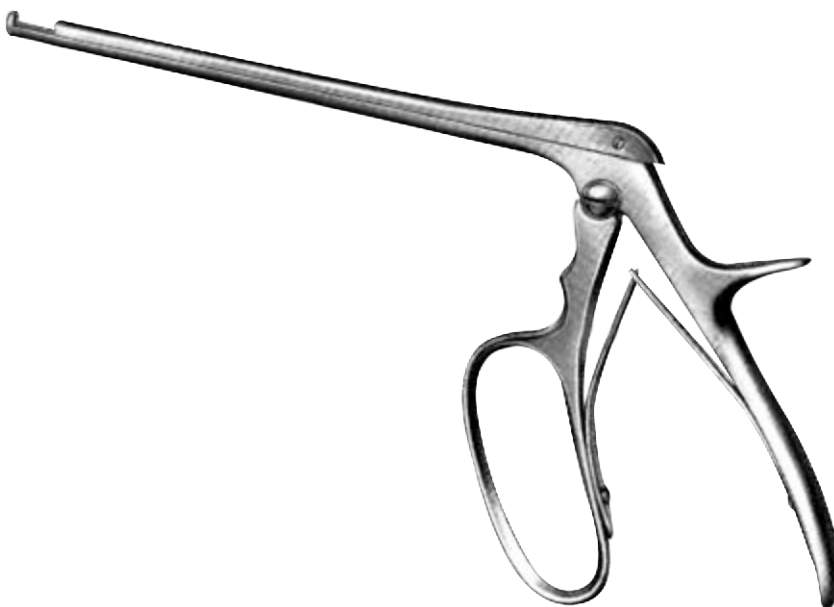

24-3385-17
18 cm/7 "
up cuttin
gjusqu'à la coupe
jusqu'à la coupe...

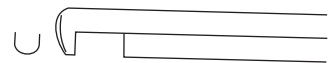

24-3386-17
18 cm/7 "
down cutting
unten schneiden
à coupe descendante
tala

Ferris-Smith-Kerrison

Rhinology Instruments

Rhinoplastic Knives
rhinoplastischen Messer

Couteaux rhinoplastie
Cuchillos Rhinoplastic



Joseph



24-3387-01
15 cm/6 "
Fig,1

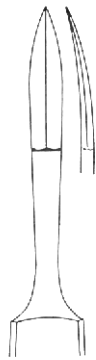

24-3387-02
15 cm/6 "
Fig,2



Fomon



24-3388-16
16,5 cm/6 1/2 "



Converse

24-3389-16
16 cm/6 1/4 "



Joseph



24-3390-15
15 cm/6 "



Cottle



24-3391-14
14 cm/5 1/2 "

Rhinology Instruments

Septum Knives, Swivel Knives
Septum Messer, Messer Swivel

Couteaux, Couteaux septum pivotantes
Cuchillos Septum, cuchillos giratorios



24



24-3392-15
16,5 cm/6½"

Freer



24-3393-19
19 cm/7 ½"

Freer



24-3394-19
19 cm/7 ½"

Freer



24-3395-19
19 cm/7 ½"

Freer



Ballenger



Ballenger



24-3396-03 3,0 mm
21cm/8 ¼"



24-3396-04 4,0 mm
21cm/8 ¼"



24-3396-05 5,0 mm
21cm/8 ¼"

24-3397-03
21cm/8 ¼"

24-3397-04
21cm/8 ¼"

24-3397-05
21cm/8 ¼"



Bruenings
24-3398-16
16 cm/6 ½"

Rhinology Instruments

Septum Elevators
Septum Aufzüge

Ascenseurs septum
Elevadores septum

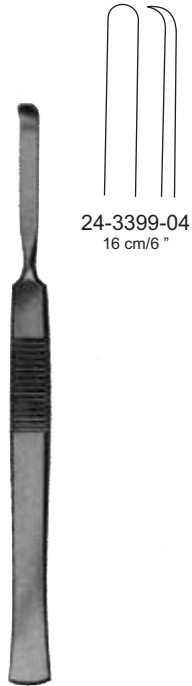

24-3399-04
16 cm/6"

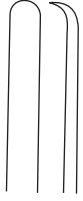

24-3399-05
16 cm/6"



24-3400-16
16 cm/6 1/2"



Cottle
24-3401-19
19.5 cm/7 1/2"

Mckenty

Joseph



24-3402-19
19 cm/7 1/2"
5mm



24-3403-19
19 cm/7 1/2"
6mm



24-3404-18
18.5 cm/7"
5/5 mm



24-3405-20
20.5 cm/8"
6/5 mm

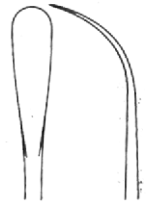

Freer

Freer

Freer

Freer

Rhinology Instruments

Septum Elevators
Septum Aufzüge

Ascenseurs septum
Elevadores septum



24

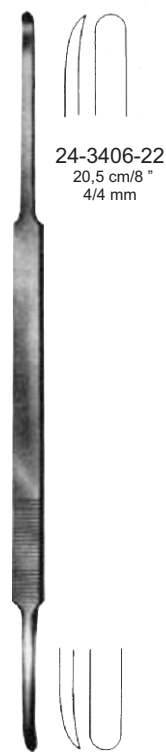

24-3406-22
20,5 cm/8"
4/4 mm

Mckenty

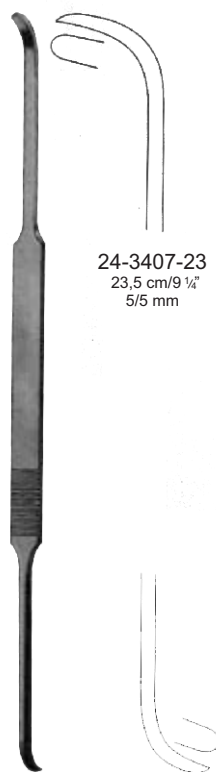

24-3407-23
23,5 cm/9 1/2"
5/5 mm

Ballenger-Hajek

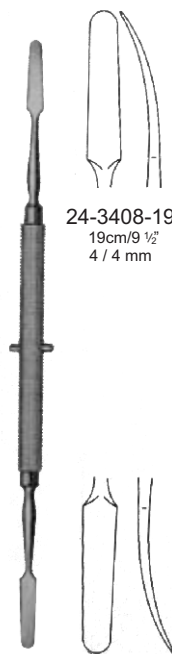

24-3408-19
19cm/9 1/2"
4 / 4 mm

Killian

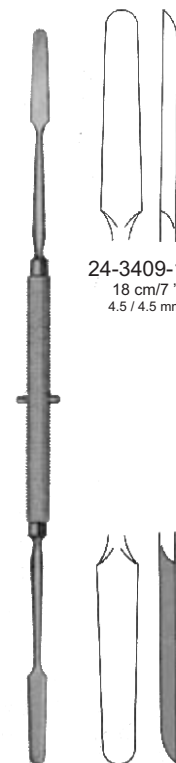

24-3409-18
18 cm/7"
4.5 / 4.5 mm

Killian



24-3410-21
21 cm/8 1/2"

Pierce

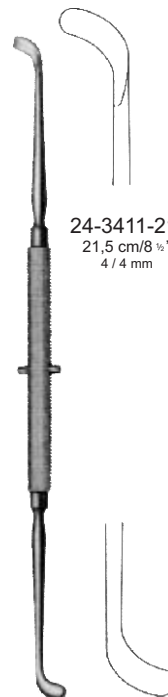

24-3411-21
21,5 cm/8 1/2"
4 / 4 mm

Pennington

Rhinology Instruments

Periosteal Elevators & Septum Chisels
Periosteal Elevators & Septum Meißel

Ascenseurs Periosteal et burins septum
Elevadores Periosteal y cinceles Septum

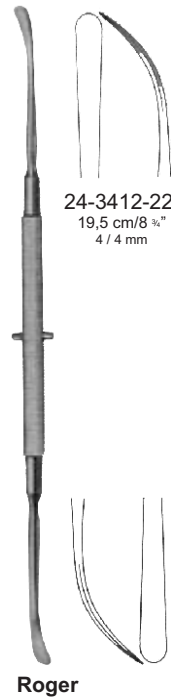

24-3412-22
19,5 cm/8 1/2"
4 / 4 mm

Roger



24-3413-22
19,5 cm/8 1/2"
4 mm

Joseph-Masing



24-3414-23
23 cm/9 "
3.3 / 3.7 mm

Cottle

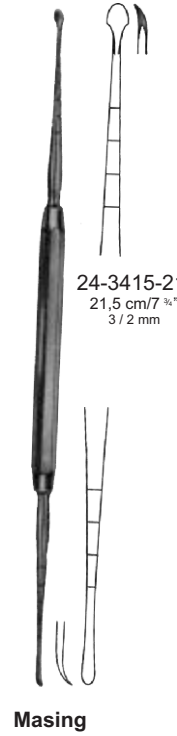

24-3415-21
21,5 cm/7 1/2"
3 / 2 mm

Masing

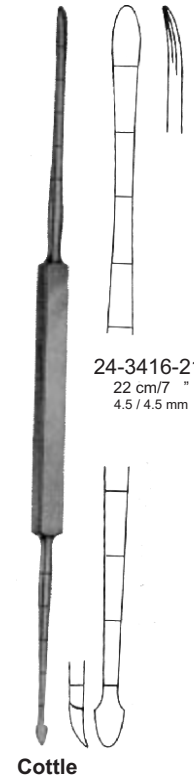

24-3416-21
22 cm/7 "
4.5 / 4.5 mm

Cottle



24-3417-22
22 cm/7 "
6.5 mm

Joseph



24-3418-16
16 cm/6 1/2"
4 mm

Freer



24-3419-17
16,5 cm/6 1/2"
4 mm

Freer



Freer
24-3420-15
15 cm/6"
6 mm

Rhinology Instruments

Septum Knives, Swivel Knives
Septum Messer, Messer Swivel

Couteaux, Couteaux septum pivotantes
Cuchillos Septum, cuchillos giratorios



24

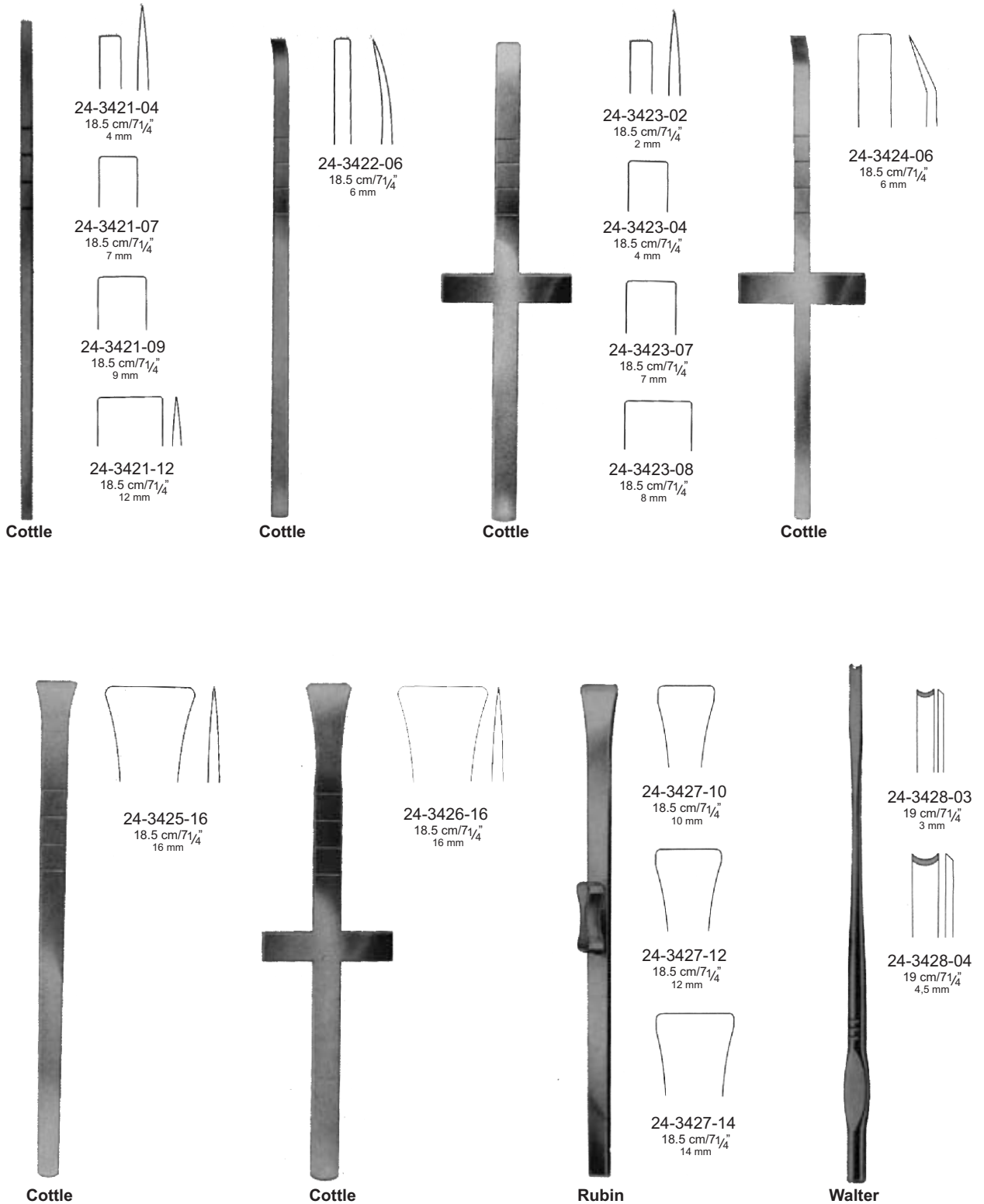

Rhinology Instruments

Septum Gouges
Septum Gouges

Gouges septum
Gouges septum



Ballenger



24-3429-02
15 cm/6"
2 mm



24-3429-04
15 cm/6"
4 mm



24-3429-06
15 cm/6"
6 mm



24-3429-08
15 cm/6"
8 mm



Killian



24-3430-16
16 cm/6 $\frac{1}{4}$ "
5 mm

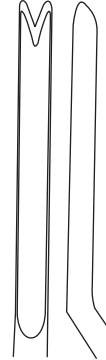

24-3431-16
16 cm/6 $\frac{1}{4}$ "
5 mm



Killian-Claus

Rhinology Instruments

Osteotomes, Gouges, Chisels
Osteotome, Hohlmeißel, Flachmeißel

Ostéotomes, gouges, ciseaux
Osteotomos, gubias, cinceles

24



Walter

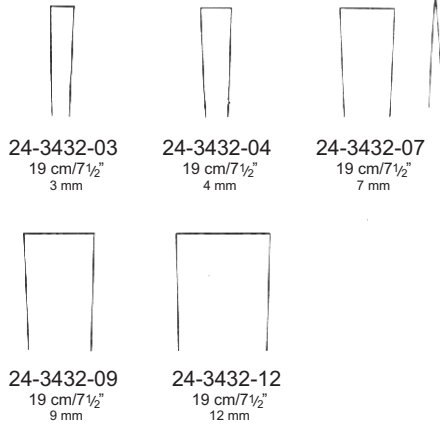

Fomon

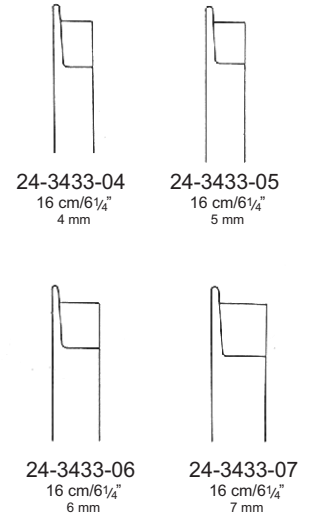

Cinelli

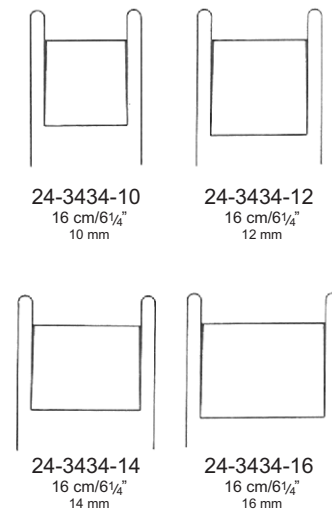

Rhinology Instruments

Rhinoplastic Chisels, Osteotomes, Nasal Saws
 Rhinoplastischen Flachmeißel, Osteotome, Nasal Sägen

Ciseaux rhinoplastie, ostéotomes, scies nasaux
 Cinceles Rhinoplástico, los osteotomos,
 Sierras nasales



24-3435-01
 18 cm/7 "
 5 mm

Silver

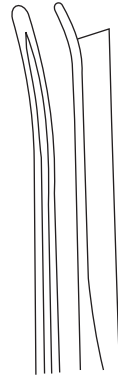

24-3435-02
 18 cm/7 "
 5 mm

Silver

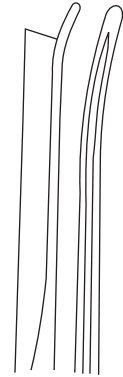

24-3435-03
 18 cm/7 "
 5 mm

Silver

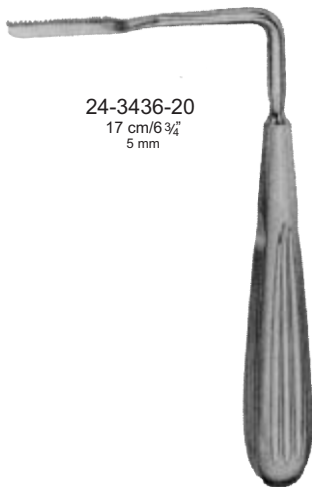

24-3436-20
 17 cm/6 3/4 "
 5 mm

Joseph

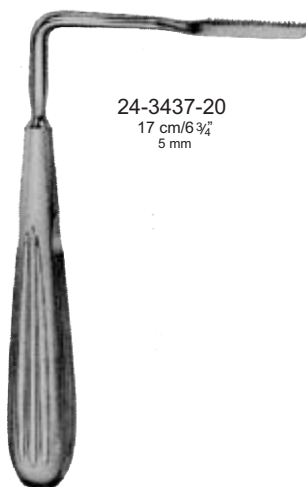

24-3437-20
 17 cm/6 3/4 "
 5 mm

Joseph



24-3438-00
 19 cm/7 1/2 "



24-3438-01
 19 cm/7 1/2 "



24-3438-02
 19 cm/7 1/2 "

Rhinology Instruments

Nasal Resps, Bone File Antrum Rasps
 Nasal RESPS, Bone Datei Antrum Raspeln

Resps nasale, Râpes os de fichiers Antre
 PRAE nasal, hueso Escofinas antro de archivos



24

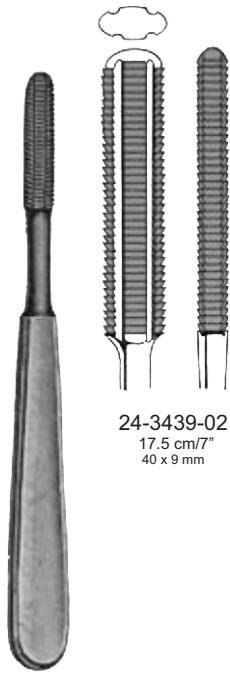

24-3439-02
 17.5 cm/7"
 40 x 9 mm

Maltz

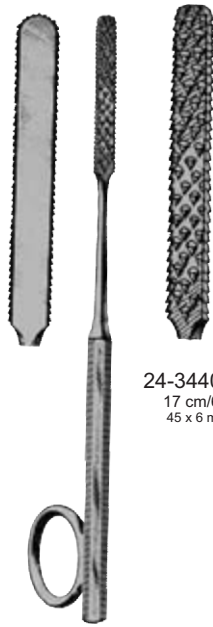

Gallaher

24-3440-01
 17 cm/6 3/4"
 45 x 6 mm



24-3440-02
 17 cm/6 3/4"
 45 x 6 mm



24-3440-03
 17 cm/6 3/4"
 45 x 6 mm

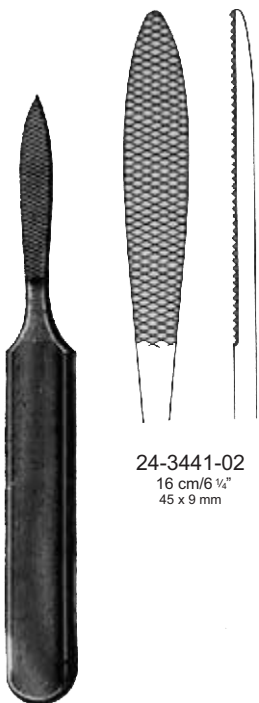

24-3441-02
 16 cm/6 1/4"
 45 x 9 mm

Joseph



Cottle

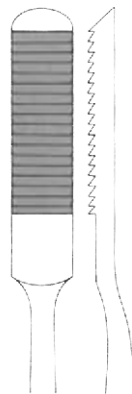

24-3442-21
 20.5 cm/8"
 30 x 8 mm



Aufricht



24-3443-21
 21 cm/8 1/4"
 32 x 9 mm



24-3444-21
 21 cm/8 1/4"
 32 x 9 mm

Rhinology Instruments

Glabella & Nasal Rasps
 Glabella Nasal & Raspeln

Râpes glabelle et nasale
 Glabela y nasal Escofinas



Lewis



24-3445-18
 19 cm/7 1/2"
 15 x 8 mm



24-3446-18
 19 cm/7 1/2"
 15 x 8 mm



Wiener

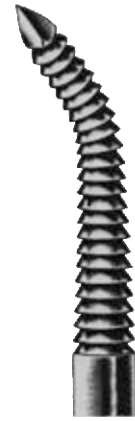

24-3447-18
 18 cm/7"



24-3448-18
 18 cm/7"



Fomon

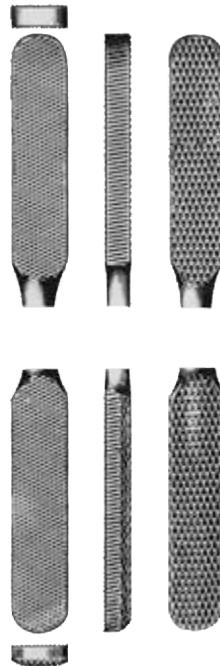

24-3449-21
 21 cm/8 1/4"

Rhinology Instruments

Nasal Rasps
nasal Raspeln

Râpes nasaux
Escofinas nasales



24



Fomon



24-3450-01
20.5 cm/8"
Fig. 1/2
30 x 8 mm



24-3450-02
20.5 cm/8"
Fig. 3/4
40 x 7 mm



24-3450-03
20.5 cm/8"
Fig. 5/6
40 x 7 mm



24-3450-04
20.5 cm/8"
Fig. 7/8
40 x 7 mm



24-3450-05
20.5 cm/8"
Fig. 9/10
40 x 7 mm



2



4



6



8



10

Rhinology Instruments

Nasal Hooks, Nasal Retractors, Mucose Hooklets

Nasal Haken, Retraktoren Nasal, Schleimhäute Häkchen

Nasale Crochets, écarteurs nasaux, petits crochets mucose

Ganchos nasal, retractores nasales, mucosa ganchillos



Joseph
24-3451-15
15.5 cm/6"



Cottle
24-3452-16
17 cm/6³/₄"



Cottle



24-3453-01
14.5 cm/5³/₄"



24-3453-02
14.5 cm/5³/₄"



24-3453-03
14.5 cm/5³/₄"



Fomon
24-3454-17
17 cm/6³/₄"



Lange
24-3455-23
23 cm/9"



Africht
24-3456-19
19 cm/7¹/₂"



Kilner
24-3457-08
8 cm/3¹/₄"



Converse
24-3458-12
11.5 cm/4¹/₂"

Rhinology Instruments

Alar Hooklets, Nasal Retractors
Alar Häkchen, Nasal Retraktoren

Petits crochets Alar, Rétracteurs nasaux
Alar ganchillos, Retractores nasales



24



Joseph



24-3459-02
16.5 cm/6½"
2 mm

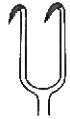

24-3459-05
16.5 cm/6½"
5 mm



24-3459-07
16.5 cm/6½"
7 mm



24-3459-10
16.5 cm/6½"
10 mm

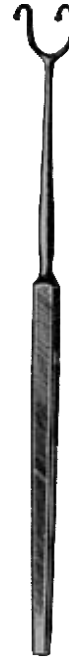

Fomon



24-3460-16
16 cm/6¼"



Cottle-Neivert
24-3461-20
19.5 cm/7 ¼"



Cottle

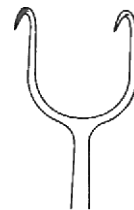

24-3462-14
14.5 cm/5¾"



24-3463-01
14.5 cm/5¾"



24-3463-02
14.5 cm/5¾"

Rhinology Instruments

Alar Hooklets, Nasal Retractors
Alar Hakchen, Nasal Retraktoren

Petits crochets Alar, Retracteurs nasaux
Alar ganchillos, Retractores nasales

24



Cottle
24-3464-14
14 cm/5½"

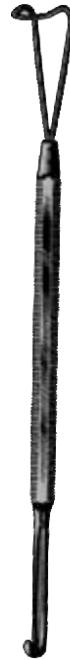

Cottle
24-3465-16
17 cm/6¾"



Cottle
24-3466-15
14 cm/6½"



Cottle
24-3467-15
16 cm/6¼"



Aufricht
24-3468-14
12 cm/4¾"

Rhinology Instruments

Septum Forceps, Septum Straightening Forceps
Septum Pinzetten, Zangen Septum Aufrichtung

Pince septum, Forceps à dresser septum
Pinzas, Pinzas Septum Septum Alisar



24



Cottle-Walsham



24-3469-01
23 cm/9"



24-3469-02
23 cm/9"



24-3469-03
23 cm/9"



Asch

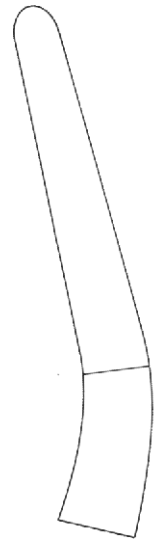

24-3470-23
22.5 cm/8 3/4"



Kressner
24-3471-20
21 cm/8 1/4"



Rubin
24-3472-20
20 cm/8"

Rhinology Instruments

Skin Grasping Forceps
Haut Faßzange

Pince à préhension de la peau
Pinzas de agarre de la piel

24



Ogura
24-3473-11
11 cm/4 1/4"



24-3474-14
14 cm/5 1/2"
1.7 mm
wide with teeth
breit mit Zähnen
largeur des dents
de ancho con dientes

Cottle



24-3475-11
11 cm/4 1/4"
12 mm wide
wide
breite
large
ancho

Cottle

Rhinology Instruments

Adenoid Curettes
adenoid Küretten

adenoïde Curettes
adenoides Curetas



24



Coakly
17 cm / 6 3/4"



24-3476-01



24-3476-02



24-3476-03



24-3476-04



24-3476-05



24-3476-06



Beckmann
24-3477-01 - 24-3477-06



Beckmann
24-3478-01 - 24-3478-06



24-3477-01
22.5 cm / 8 3/4"
Fig. 1
13 mm



24-3477-02
22.5 cm / 8 3/4"
Fig. 2
15 mm



24-3477-03
22.5 cm / 8 3/4"
Fig. 3
17 mm

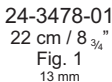

24-3478-01
22 cm / 8 3/4"
Fig. 1
13 mm

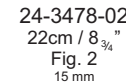

24-3478-02
22cm / 8 3/4"
Fig. 2
15 mm

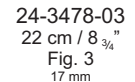

24-3478-03
22 cm / 8 3/4"
Fig. 3
17 mm



24-3477-04
22.5 cm / 8 3/4"
Fig. 1
19 mm



24-3477-05
22.5 cm / 8 3/4"
Fig. 2
21 mm



24-3477-06
22.5 cm / 8 3/4"
Fig. 3
23 mm

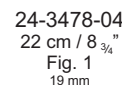

24-3478-04
22 cm / 8 3/4"
Fig. 1
19 mm

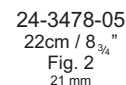

24-3478-05
22cm / 8 3/4"
Fig. 2
21 mm

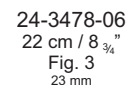

24-3478-06
22 cm / 8 3/4"
Fig. 3
23 mm

Rhinology Instruments

Suction Rasparatory
Saug Rasparatory

Rasparatory aspiration
succión Rasparatory



Guilen

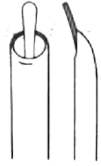

24-3479-20
19 cm / 7 1/2"



Elcken - Killian
24-3480-03
3 mmø



Ritter - Halle
24-3481-25 2.5 mm
24-3481-30 3.0 mm
24-3481-40 4.0 mm

Oral Maxillo Facial Surgery

Elevators, Graft Packers
Aufzüge, Graft Packers

Ascenseurs, Packers greffon
Ascensores, Packers injerto

25



Terry



25-3483-11
11 cm / 4 3/8"



Terry
17 cm / 6 3/4"



25-3484-17
6.0 / 8.0 mm



25-3485-13
13 cm / 6"



Terry
18 cm / 7"



25-3486-18
3.5 / 7.0 mm



Oral Maxillo Facial Surgery

Sinus Lift Currettes
Sinus Lift Küretten

Currettes Sinus Lift
Sinus Lift Curetetas



25-3487-01
18 cm / 7"
2.6 / 2.6 mm



25-3487-02
17.5 cm / 7"
2.5 / 2.5 mm



25-3487-03
17.5 cm / 7"
2.5 / 2.5 mm



25-3487-04
18.5 cm / 7 1/4"
2.5 / 2.5 mm



25-3487-05
19 cm / 7 1/2"
2.5 / 2.5 mm



25-3487-06
18.5 cm / 7 1/4"
6.7 / 6.7 mm



25-3487-07
16 cm / 6 1/4"
2.8 / 6.2 mm



25-3487-08
16 cm / 6 1/4"
2.8 / 6.2 mm



25-3487-09
15 cm / 6"
3.1 / 3.1 mm



25-3487-10
17 cm / 6 3/4"
5.5 / 5.5 mm



Oral Maxillo Facial Surgery

Sinus Lift Currettes
Sinus Lift Küretten

Currettes Sinus Lift
Sinus Lift Curetas



25

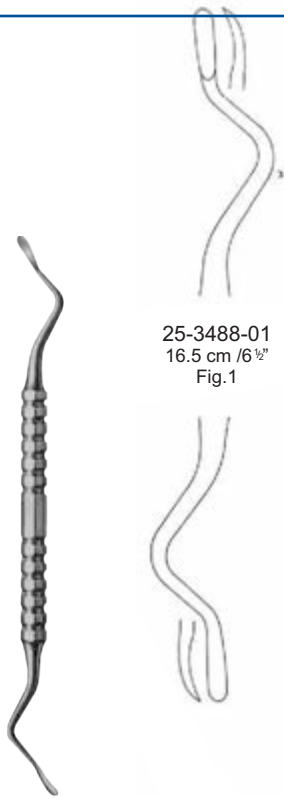

25-3488-01
16.5 cm / 6 1/2"
Fig.1



25-3488-02
16.5 cm / 6 1/2"
Fig.2

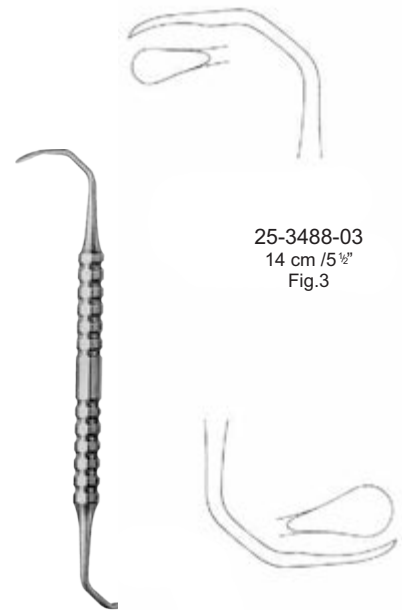

25-3488-03
14 cm / 5 1/2"
Fig.3

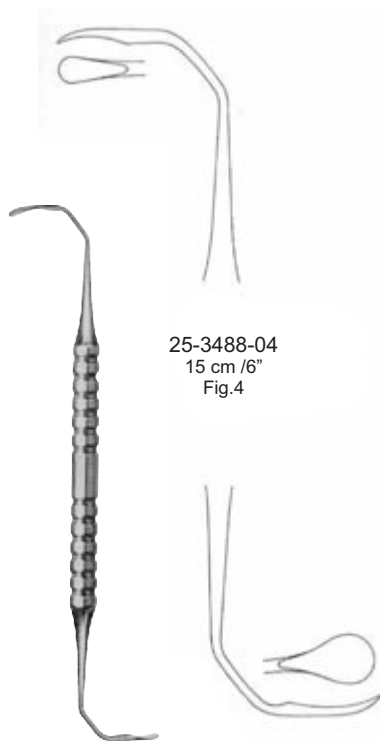

25-3488-04
15 cm / 6"
Fig.4

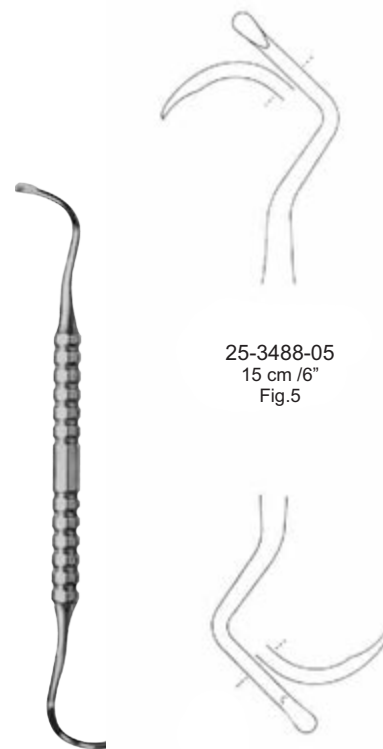

25-3488-05
15 cm / 6"
Fig.5

Oral Maxillo Facial Surgery

Burrs & Finger Protector, Mouth Gags
Grate und Fingerschutz, Mund Gags

Bavures & Finger Protector, Mouth Gags
Las rebabas y el dedo protector, la boca Nauceas



25-3489-45
4.5 cm / 1 3/4"
10 mm



25-3489-65
6.5 cm / 2 1/2"
22 mm



25-3489-80
8 cm / 3 1/4"
35 mm



Adams
25-3490-01

Napkin Holder Consisting of chain and two crocodile forceps
Napkin Holder Bestehend aus Kette und zwei Krokodil Pinzette
Napkin Holder Composée de chaîne et deux pinces crocodile
Servilletero Consistente en cadena y dos pinzas de cocodrilo



Langenbeck
25-3491-02
21 mm ø



Mauder
25-3492-10
wood
Holz
bois
madera

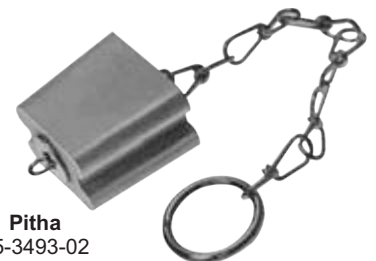

Pitha
25-3493-02
Silicone
Silikon
silicone
silicona

Oral Maxillo Facial Surgery

Mouth Gags
Mund Gags

Gags bouche
Mordaza De la Boca



25



Heister
25-3494-13
13 cm / 5"



Obwegeser
25-3495-11
11 cm / 4 1/4"



Molt
25-3496-11
11 cm / 4 1/4"



Molt
25-3497-11
13 cm / 5"



Denhart
25-3498-11
13 cm / 5"



Roser-Konig



25-3499-16
16 cm / 6 1/4"

25-3499-20
20 cm / 8"

Oral Maxillo Facial Surgery

Mouth Gags
Mund Gags

Gags bouche
Mordaza De la Boca



Kilner-Doughty
25-3500-00
Chest Support



Kilner-Doughty
25-3501-00

complete with frame, 3 tongue depressors
2 tooth plate and 1 palate plate
komplett mit Rahmen, 3 Zungenspatel
2 Zahnplatte und 1 Gaumenplatte
compléter avec cadre, 3 abaisse-langue
2 plaque dentaire et 1 plaque palatine
completar con marco, 3 depresores de lengua
2 diente placa y 1 placa paladar



25-3501-01
13.5 cm / 5 1/4"
70 x 29 mm



25-3501-02
13.5 cm / 5 1/4"
80 x 34 mm



25-3501-03
13.5 cm / 5 1/4"
85 x 38 mm



Oral Maxillo Facial Surgery

Mouth Gags
Mund Gags

Gags bouche
Mordaza De la Boca

25



Davis-Boyle
25-3502-00

complete consisting of frame and five tongue depressors no. 1 to 5
komplett bestehend aus Rahmen und fünf Zungenspatel keine, 1 bis 5
compléter consistant en un cadre et cinq abaisse-langue non, de 1 à 5
completar consistente en un marco y cinco depresores de lengua no, desde 1 hasta 5



Davis-Boyle
25-3502-01
13.5 cm / 5 ¼"
110 x 26 mm
Tongue depressor
Zungenspatel
abaisse-langue
depresor de lengua



25-3502-02
13.5 cm / 5 ¼"
95 x 25 mm



25-3502-03
13.5 cm / 5 ¼"
80 x 24 mm



25-3502-04
13.5 cm / 5 ¼"
65 x 23 mm



25-3502-05
13.5 cm / 5 ¼"
30 x 20 mm

Oral Maxillo Facial Surgery

Mouth Gags
Mund Gags

Gags bouche
Mordaza De la Boca

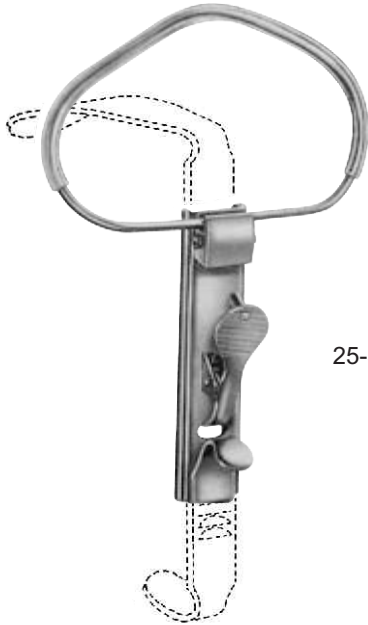

Mclvor

25-3503-00

25-3503-10
15 cm / 6"
Frame for Mouth Gag
65 x 100 mm

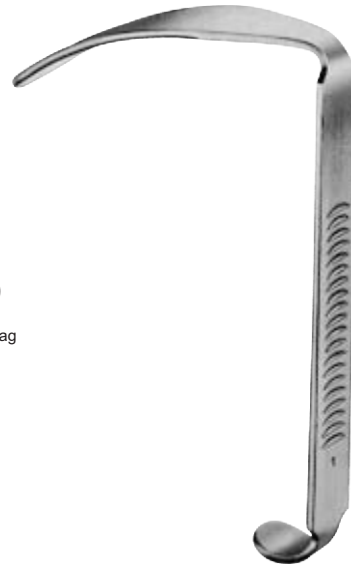

25-3503-01
13.5 cm / 5 1/4"
100 x 26 mm

Mclvor
Tongue Depressor



25-3503-02
13.5 cm / 5 1/4"
85 x 25 mm



25-3503-03
13.5 cm / 5 1/4"
75 x 23 mm

Oral Maxillo Facial Surgery

Mouth Gags
Mund Gags

Gags bouche
Mordaza De la Boca



25

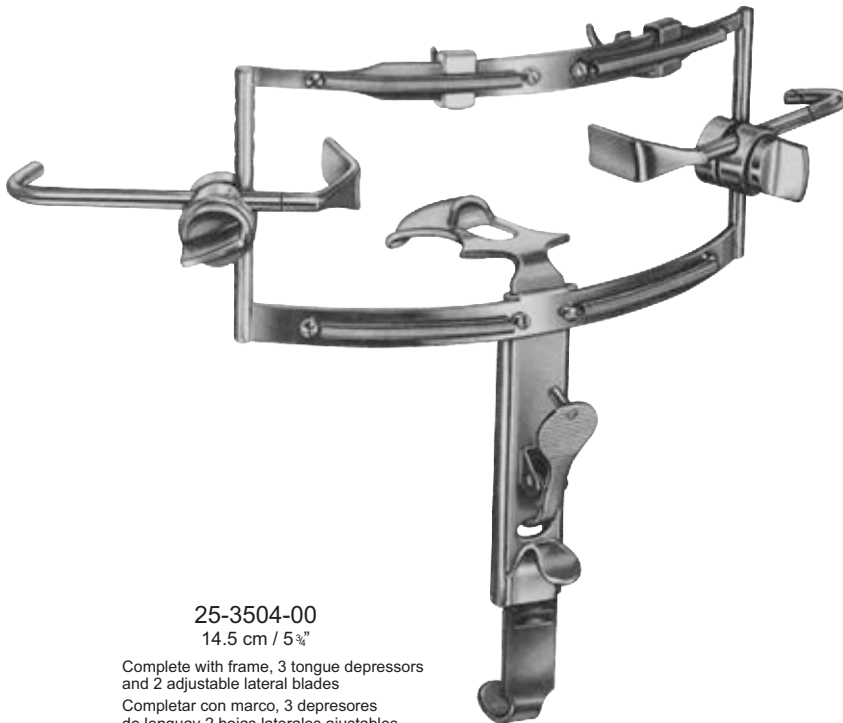

25-3504-00
14.5 cm / 5 3/4"

Complete with frame, 3 tongue depressors and 2 adjustable lateral blades

Completar con marco, 3 depresores de lengua y 2 hojas laterales ajustables

Compléter avec cadre, 3 abaisse-langue et 2 réglables lames latérales

Completar con marco, 3 depresores de lengua y 2 hojas laterales ajustables

Dingmann

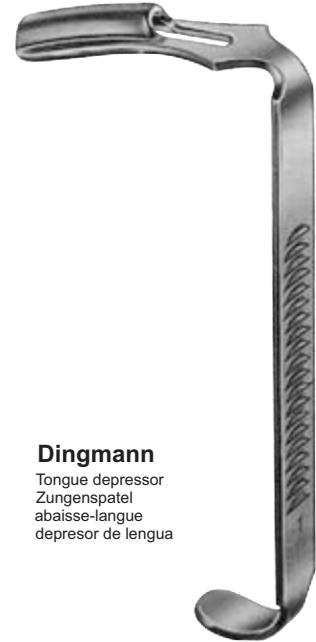

Dingmann

Tongue depressor
Zungenspatel
abaisse-langue
depressor de lengua

25-3504-01
13.5 cm / 5 1/4"
65 x 25 mm

Dingmann

Tongue depressor
Zungenspatel
abaisse-langue
depressor de lengua



25-3504-02
13.5 cm / 5 1/4"
70 x 29 mm

25-3504-03
13.5 cm / 5 1/4"
80 x 32 mm



Jenninge

25-3505-09 10.5 cm / 4"
25-3505-11 12.5 cm / 5"
25-3505-13 10.5 cm / 5 3/4"
25-3505-15 10.5 cm / 6 1/2"

Oral Maxillo Facial Surgery

Lip and Cheek Retractors
Lippen-und Wangenhalter

Rétracteurs lèvre et la joue
Separadores de labios y mejillas



25-3506-00 9.5 cm / 3 3/4" 95 mm

25-3506-01 10 cm / 4" 110 mm

25-3506-02 10.5 cm / 4" 115 mm

25-3506-03 11 cm / 4 1/4" 120 mm

25-3506-13

Jenninge

self-retaining
selbsthaltende
autostatique
auto-retención

For Children
für Kinder
pour les enfants
Para los niños

set with no. 1-3
establecido con el n. 1-3
mis à aucune. 1-3
establecido con el n. 1-3

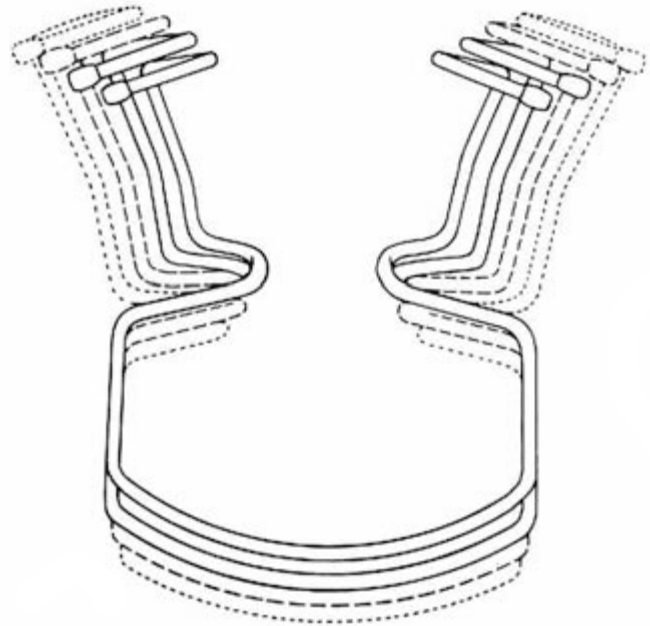

25-3507-11
10.5 cm / 4"



25-3508-14
14 cm / 5 1/2"



Sternberg
25-3509-14
14 cm / 5 1/2"
26 / 37 mm

Oral Maxillo Facial Surgery

Cheek Retractors
Wangenhalter

écarteurs
retractores de carrillos



25

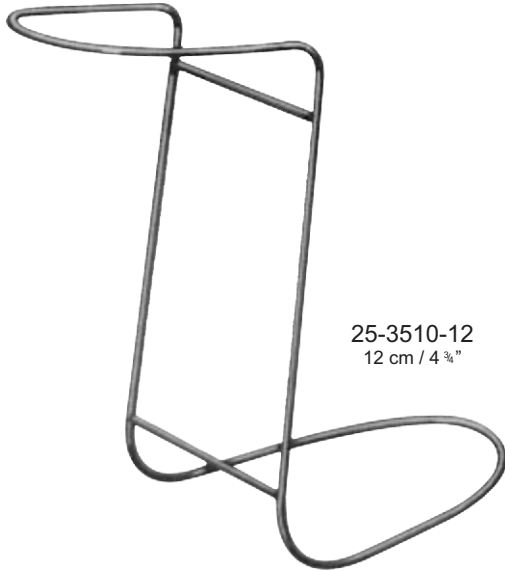

25-3510-12
12 cm / 4 3/4"

Obwegeser



25-3511-12
13.5 cm / 5 1/4"
27 mm

Bishop



25-3512-15
13.5 cm / 6"
20 mm

Cawood-Minnesota



25-3513-00
14.5 cm / 5 3/4"
Fenestrated
gefenstert
Fenestrated
fenestrados

Oral Maxillo Facial Surgery

Tongue Depressors
Zungenspatel

Abaisse-langue
depresores de lengua



Tobold



25-3514-14
15 cm / 6"
88 x 25 mm



Tobold



25-3515-14
14.5 cm / 5 7/8"
85 x 24 mm



Hartmann



25-3516-15
15 cm / 6 3/4"
72 x 23 mm



Wieder



25-3517-01
14 cm / 5 1/2"
36 mm



25-3517-02
15 cm / 6"
43 mm

Oral Maxillo Facial Surgery

Tongue Spatulas
Zungenspatel

Spatules Tongue
Espátulas Lengua



25



Doyen



25-3518-13
13.5 cm / 5 1/4"
24 / 30 mm

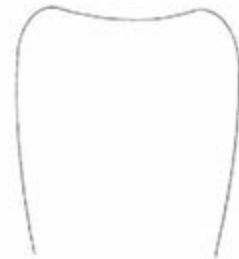

25-3518-16
16 cm / 6 1/4"
30 / 34 mm



25-3519-16
15 cm / 6"

Package of 100
pieces plastic
Paket von 100
Stück Kunststoff
Paquet de 100
plastique morceaux
Paquete de 100
piezas de plástico



25-3520-16
16 cm / 6 1/4"

Package of 100
pieces wood
Paket von 100
Stück Holz
Paquet de 100
des morceaux de bois
Paquete de 100
piezas de madera



25-3521-19
19 cm / 7 1/2"
19 / 15 mm



Brunings

Oral Maxillo Facial Surgery

Tongue Holding Forceps
Zungenzangen

Tongue Davier
Lengua pinzas de sujeción

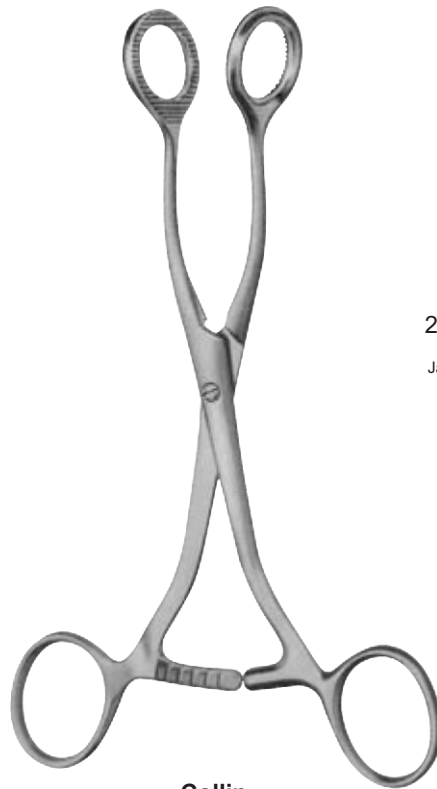

Collin

25-3522-17
17 cm / 6 ³/₄"
Jaw 24 x 27 mm

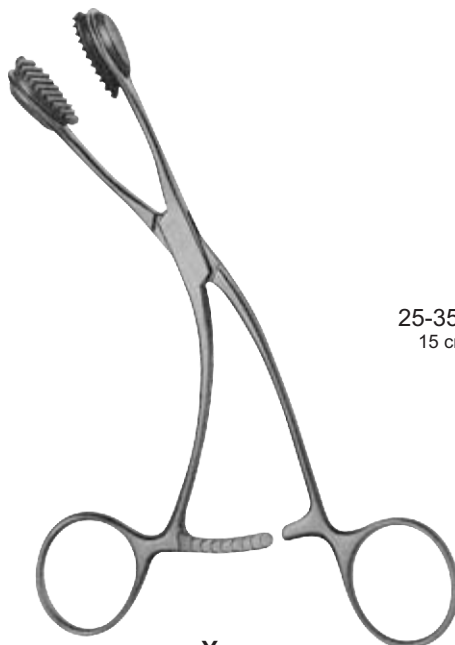

Young

25-3523-15
15 cm / 6"



25-3524-02
Rubber Inserts
23 x 15 mm

Rubber Inserts
Gummielagen
Inserts en caoutchouc
Insertos de goma

Oral Maxillo Facial Surgery

Extra Oral Retractors
Extraoralen Retraktoren

Supplémentaires Rétracteurs orale
Retractores extra orales



25



25-3525-24
22 cm / 8 3/4"
9.5 mm / 16 mm

concave blade, fully bent tip
konkave Klinge, komplett gebogene Spitze
concave lame, pointe entièrement plié
cóncava hoja, tip completamente doblado



25-3526-25
25.5 cm / 10"
9.5 mm / 16 mm

concave blade, fully bent tip
konkave Klinge, komplett gebogene Spitze
concave lame, pointe entièrement plié
cóncava hoja, tip completamente doblado

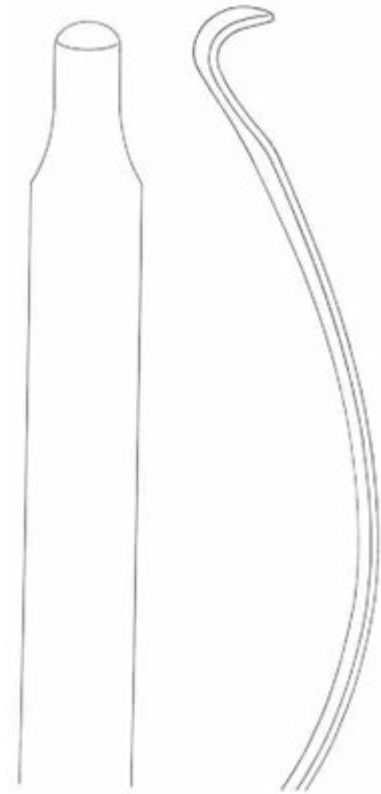

Oral Maxillo Facial Surgery

Intra Oral Retractors
Intra Oral Retraktoren

Intra Rétracteurs orale
Retractores Intra Oral



25-3527-23
23 cm / 9"
25.5 mm

for Lefort osteotomies
für Lefort Osteotomien
pour Lefort ostéotomies
osteotomias Lefort para



25-3528-27
27 cm / 10³/₄"
25.5 mm

for Lefort osteotomies
für Lefort Osteotomien
pour Lefort ostéotomies
osteotomias Lefort para

Oral Maxillo Facial Surgery

Intra Oral Retractors
Intra Oral Retraktoren

Intra Rétracteurs orale
Retractores Intra Oral



25



25-3529-21
21 cm / 8 1/4"
26.5 / 16 mm
Right
rechts
droit
derecho



25-3530-21
21 cm / 8 1/4"
26.5 / 16 mm
Left
links
links
Izquierda



25-3531-24
24.5 cm / 9 3/4"
26.5 / 16 mm
Right
rechts
droit
derecho



25-3532-24
24.5 cm / 9 3/4"
26.5 / 16 mm
Left
links
links
Izquierda

Oral Maxillo Facial Surgery

Intra Oral Retractors
Intra Oral Retraktoren

Intra Rétracteurs orale
Retractores Intra Oral



25-3533-25
25 cm / 9"
12.5 / 27 mm



25-3534-28
28 cm / 11"
12.5 / 27 mm

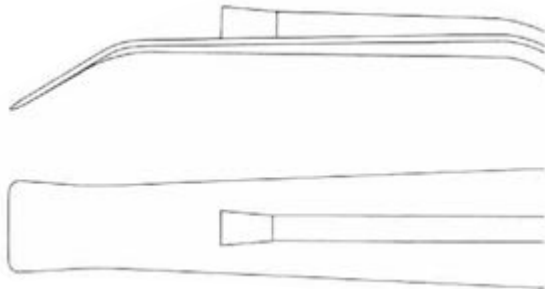
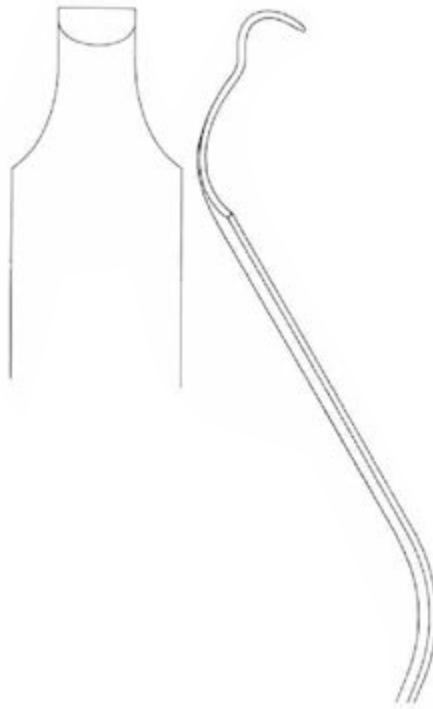

25-3535-22
22 cm / 8 3/4"
14.5 mm

Shea
Multi Purpose Retractor
Multi Purpose Retractor
Écarteur Multi Purpose
Retractor multiuso

Oral Maxillo Facial Surgery

Ramus Retractors
Ramus Retraktoren

Rétracteurs Ramus
Los retractoros de rama



25



25-3536-40
21.5 cm / 8 1/2"
43 x 11 mm

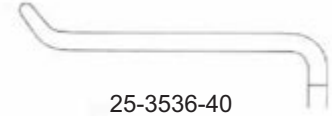

25-3536-55
21.5 cm / 8 1/2"
57 x 11 mm

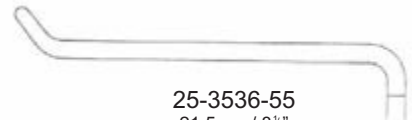

25-3536-80
21.5 cm / 8 1/2"
83 x 16 mm

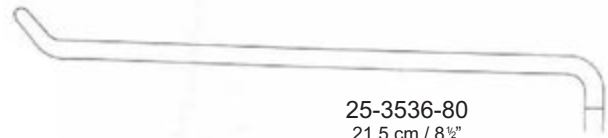

25-3537-22
22 cm / 8 3/4"
Nasal Spine Retractor
45 x 10 mm

Nasal Spine Retractor
Nasal Spine Retractor
Écarteur épine nasale
Retractor nasal Columna Vertebral

Obwegeser

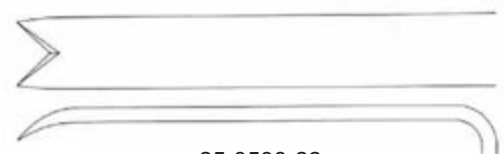

25-3538-22
22 cm / 8 3/4"
75 x 10 mm

Obwegeser

Oral Maxillo Facial Surgery

Progeny Retractor
Progeny Retractor

Ecarteur Progeny
Progenie retractor



Obwegeser
25-3539-16
16.5 cm / 6 1/2"



Obwegeser
25-3540-08 17 cm / 6 3/4" 8 mm
25-3540-10 17 cm / 6 3/4" 10 mm



25-3541-10
15 cm / 6"

Schuchardt

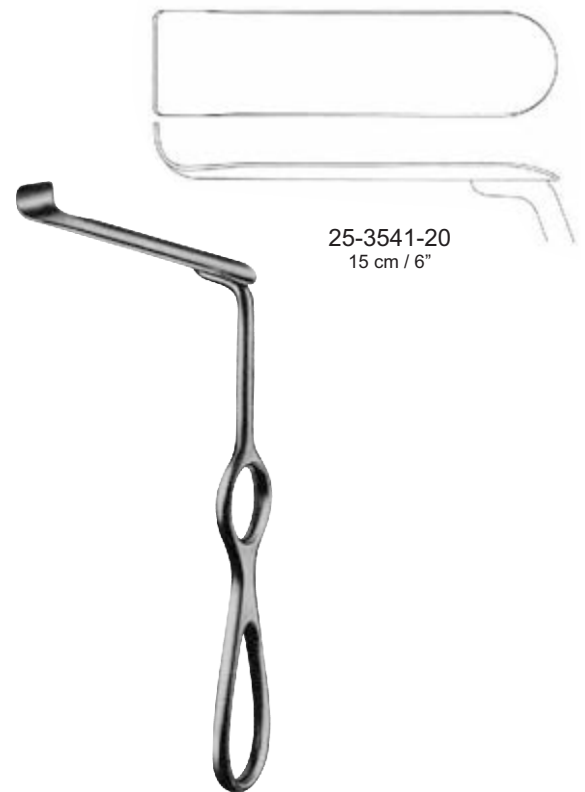

25-3541-20
15 cm / 6"

Metz

Oral Maxillo Facial Surgery

Retractors, Periosteal Elevators
Retraktoren, Raspatorien

Rétracteurs, rugines
Retradores, ascensores periostio

25



Koberg, mod



25-3542-01
18.5 cm / 7 1/4"
14 x 7 mm



25-3542-02
18.5 cm / 7 1/4"
20 x 7 mm



25-3543-01
18 cm / 7"
3x18 mm



25-3543-02
18 cm / 7"
3.5x23 mm



Obwegeser



25-3544-06
17.5 cm / 7"
6 mm



25-3544-07
17.5 cm / 7"
7 mm



25-3544-09
17.5 cm / 7"
9 mm



25-3544-11
17.5 cm / 7"
11 mm

Oral Maxillo Facial Surgery

Periosteal Elevators, Elevators
Raspatorien, Aufzüge

Rugines, Ascenseurs
Ascensores, elevadores periósticos



25-3545-05
20.5 cm / 8"
5 mm



25-3545-07
20.5 cm / 8"
7 mm



25-3545-09
20.5 cm / 8"
9 mm

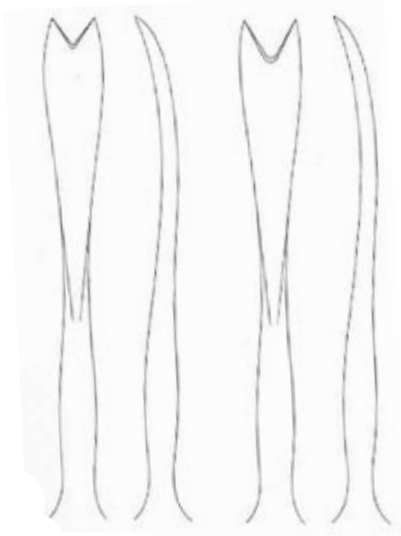

25-3546-01

25-3546-02

Obwegeser

Obwegeser
17.5 cm / 7"



25-3547-21

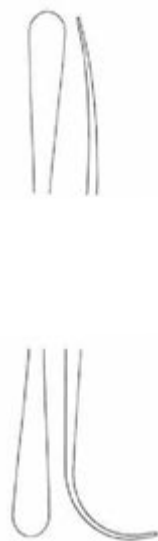

25-3548-21

Obwegeser
20.5 cm / 8"

Obwegeser
20.5 cm / 8"



Hargis



25-3549-01
23 cm / 9"
6.5 mm
Right
rechts
droit
derecho



25-3549-02
23 cm / 9"
9 mm
Right
rechts
droit
derecho



25-3549-03
23 cm / 9"
6.5 mm
Left
links
links
Izquierda



25-3549-04
23 cm / 9"
9 mm
Left
links
links
Izquierda

Oral Maxillo Facial Surgery

Zygoma Elevators, Channel Retractor
Zygoma Aufzüge, Channel Retractor

Ascenseurs Zygoma, écarteur Manche
Zygoma elevadores, separador de canales



25



25-3550-21

Gillies
20 cm / 8"



25-3551-21
5.0 mm \varnothing

Dingmann
21 cm / 8 1/4"



25-3552-19

Dingmann-Wilk
20 cm / 8"



25-3553-18
18.5 cm / 7 1/4"

Steinhauser



Steinhauser



25-3554-00
27 cm / 10 1/4"

Oral Maxillo Facial Surgery

Periosteal Elevators
Raspatorien

Rugines
Elevadores periostio



25-3555-18
18 cm / 7"

Steinhauser

Reposition Instruments
positionieren Instruments
repositionner Instruments
Vuelva a colocar los instrumentos

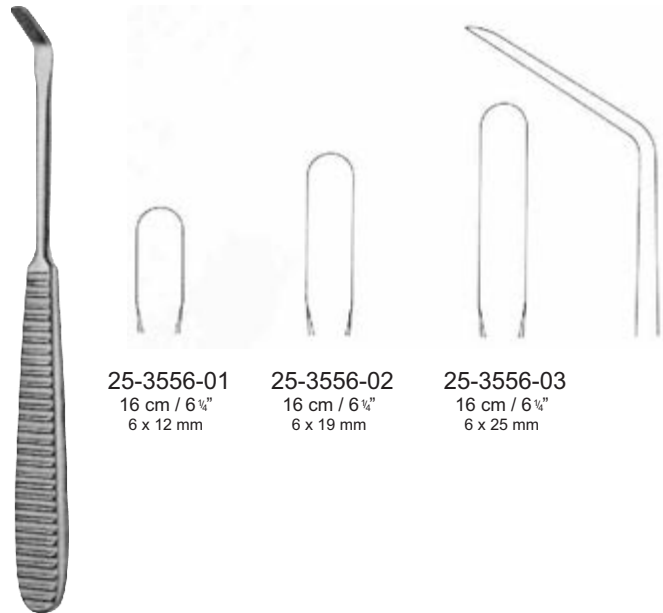

25-3556-01
16 cm / 6 1/4"
6 x 12 mm

25-3556-02
16 cm / 6 1/4"
6 x 19 mm

25-3556-03
16 cm / 6 1/4"
6 x 25 mm

Steinhauser

Oral Maxillo Facial Surgery

Lattice Splints
Lattice Schienen

attelles en treillis
Las tablillas de celosía



25



25-3557-02

Package with 10 pieces
Packung mit 10 Stück
Paquet de 10 pièces
Paquete con 10 piezas



25-3558-13

13 cm / 5"

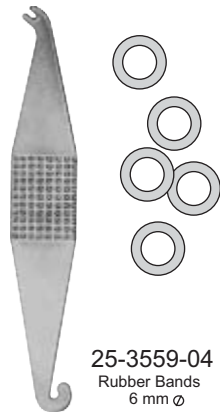

25-3559-04

Rubber Bands
6 mm Ø

Rubber Bands
bandes élastiques
Las bandas de goma

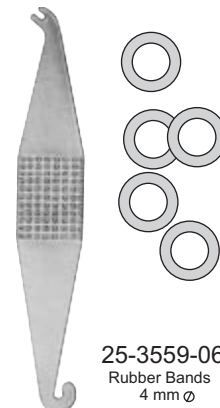

25-3559-06

Rubber Bands
4 mm Ø

Rubber Bands
bandes élastiques
Las bandas de goma

Oral Maxillo Facial Surgery

Wire Pushers, Arch Bar
 Draht-Pusher, Arch Bar

Poussoirs fils, Arch Bar
 Los empujadores de alambre, Arch Bar



25-3560-00
 17 cm / 6 3/4"



25-3561-00
 15 cm / 6"

Rowe



25-3562-01
 15 cm / 6"



Mershon

Oral Maxillo Facial Surgery

Bone Holding Forceps
Knochenhaltezangen

Os Davier
Bone Pinzas

25

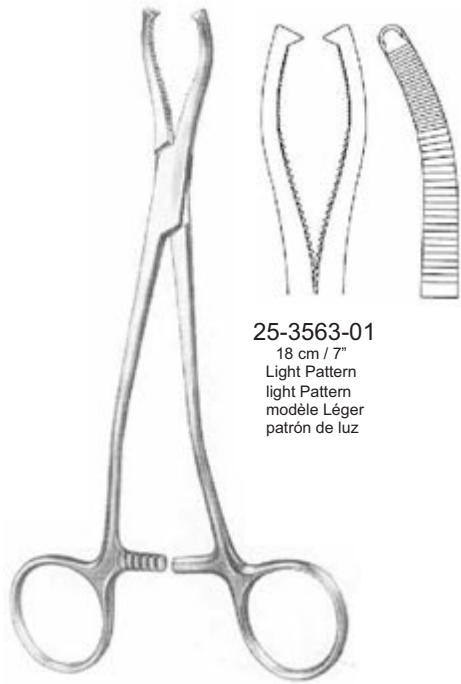

25-3563-01
18 cm / 7"
Light Pattern
light Pattern
modèle Léger
patrón de luz

Jeter-Van Sickels

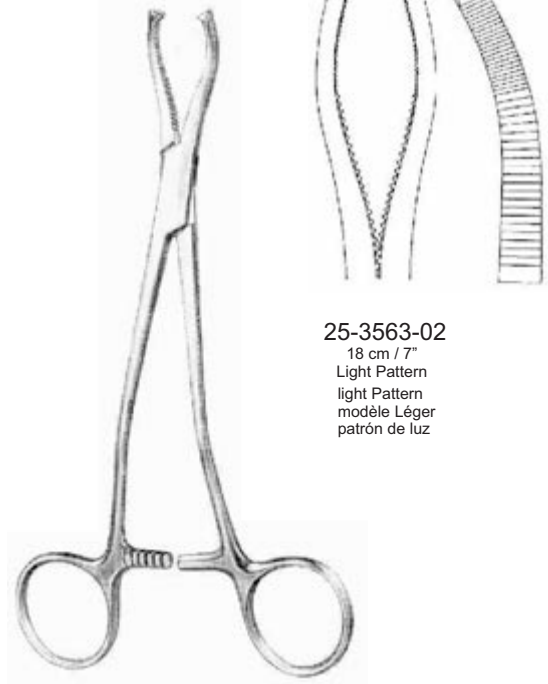

25-3563-02
18 cm / 7"
Light Pattern
light Pattern
modèle Léger
patrón de luz

Jeter-Van Sickels

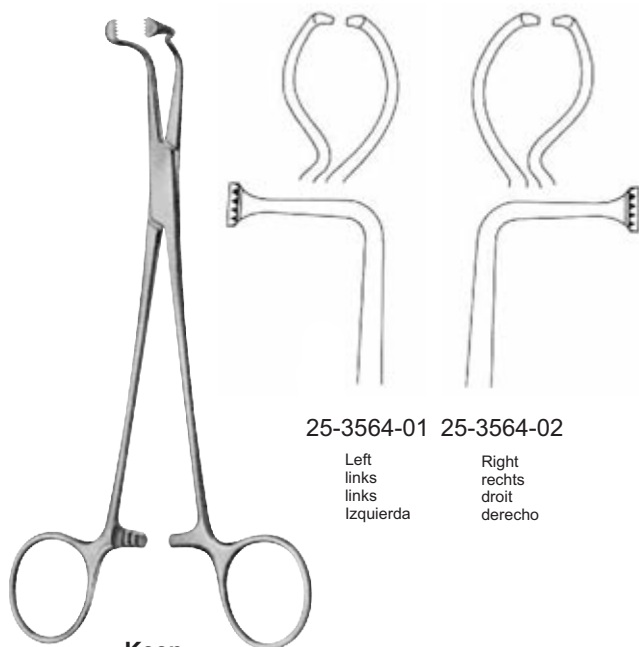

25-3564-01 25-3564-02
Left links links izquierda
Right rechts droit derecho

Keen
17.5 cm / 6 3/4"



Steinhauser
25-3565-01
13cm / 5"



Steinhauser
25-3565-02
13cm / 5"

Oral Maxillo Facial Surgery

Bone Holding Forceps
Knochenhaltezangen

Os Davier
Bone Pinzas



Sakamoto
25-3566-00
14cm / 5 1/2"



25-3567-00
16 cm / 6 1/2"

Salyer



25-3568-25
25 cm / 10"

Wolford



25-3569-25
19 cm / 7 1/2"
with chain
mit Kette
avec la chaîne
con cadena

Hargis

Oral Maxillo Facial Surgery

Disimpaction Forceps
disimpaction Zange

Pince désimpaction
Pinzas desimpactación

25



Rowe
Left
links
links
Izquierda



25-3570-01
25-3571-01
22.5 cm / 8 3/4"
Left



25-3570-02
25-3571-02
23.5 cm / 9 1/4"



Rowe
Right

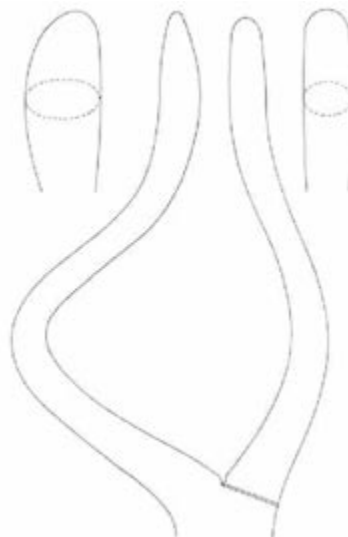

Oral Maxillo Facial Surgery

LeFort I Retractors, Sinus Lift and Zygomatic Retractors
 LeFort I Retraktoren, Sinus Lift und Jochbein Retraktoren

Lefort Rétracteurs I, Sinus Lift et Rétracteurs zygomatiques
 Lefort I retractores, Sinus Lift y retractores cigomáticos



Arnhem

22 cm / 8 3/4"

Lefort I Retractor
 Lefort enrouleur je
 Lefort I Retractor

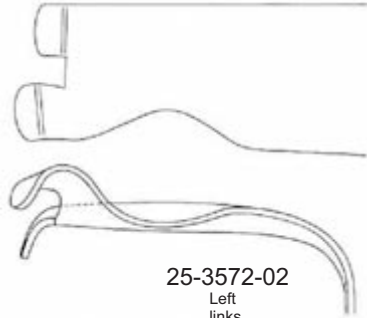

25-3572-02

Left
 links
 links
 Izquierda

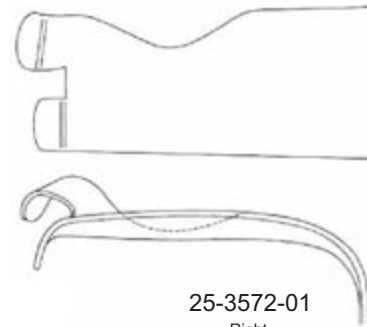

25-3572-01

Right
 rechts
 droit
 derecho



Arnhem

22 cm / 8 3/4"

Sinus Lift Retractor
 Écarteur Sinus Lift
 Sinus Lift Retractor

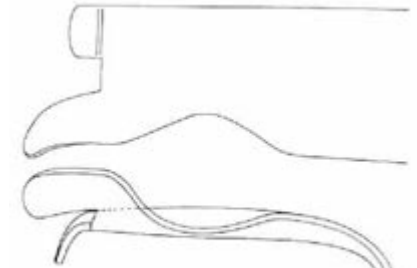

25-3573-02

Left
 links
 links
 Izquierda

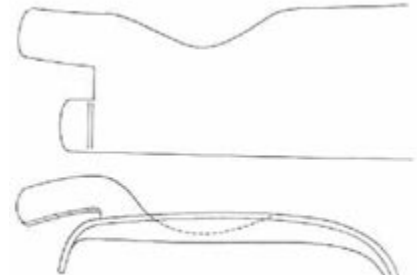

25-3573-01

Right
 rechts
 droit
 derecho



Steinhauser



25-3574-01

23 cm / 9"
 20 x 50 mm
 Right
 rechts
 droit
 derecho



25-3574-02

23 cm / 9"
 20 x 50 mm
 Left
 links
 links
 Izquierda

Oral Maxillo Facial Surgery

Ramus Retractor, Mandibular Body Retractor,
Anterior Border Stripper , Periform Rim Retractor
Ramus Retractor, Gebissknochen, Retraktor
Vorderen Rand Stripper, PERiform Rim Retractor

Ecarteur Ramus, corps de la mandibule, enrouleur,
Décapant bord antérieur, Periform Rim Écarteur
Separador de rama, cuerpo mandibular, retractor,
Stripper borde anterior, periforme culo retractor



Hargis

Lip and Cheek Retractors
Lippen-und Wangenhalter
Ecarteurs lèvre et la joue
Labios y Mejillas Retractores

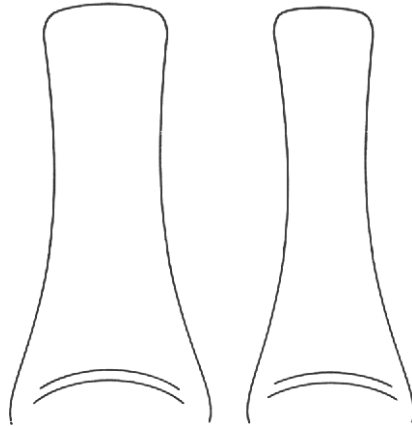

25-3575-00
16 cm / 6 1/4"



Hargis

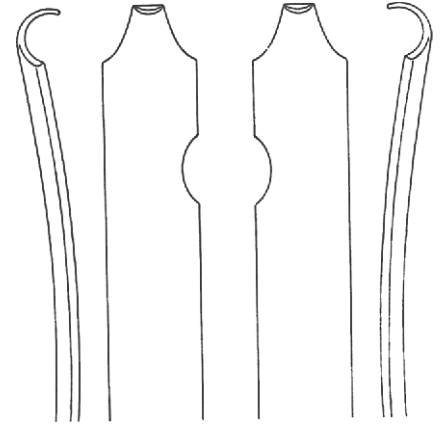

25-3576-01
19.5 cm / 7 3/4"
Right
rechts
droit
derecho

25-3576-02
19.5 cm / 7 3/4"
Left
links
links
Izquierda



25-3577-18
18 cm / 7 "

Hargis



25-3578-19
19 cm / 7 1/2"

Hargis



25-3579-18
18.5 cm / 7 1/4"

Hargis

Oral Maxillo Facial Surgery

Sagittal Split Separators, Ramus Separator
Sagittal Split Separatoren, Ramus Separator

Séparateurs clivage sagittal, les séparateurs Ramus
Separadores Sagital Split, separadores Ramus



25



Smith



25-3580-01
18.5 cm / 7 1/4"
9 mm
Right
rechts
droit
derecho



Smith



25-3580-02
18.5 cm / 7 1/4"
9 mm
Left
links
links
Izquierda



Smith



25-3581-23
23.5 cm / 9 1/4"

Oral Maxillo Facial Surgery

Mylohyoid Muscle and Ramus Clamps
M. mylohyoideus und Ramus Schellen

Muscle mylo-hyoïdien et pincés Ramus
Músculo milohioideo y abrazaderas de rama

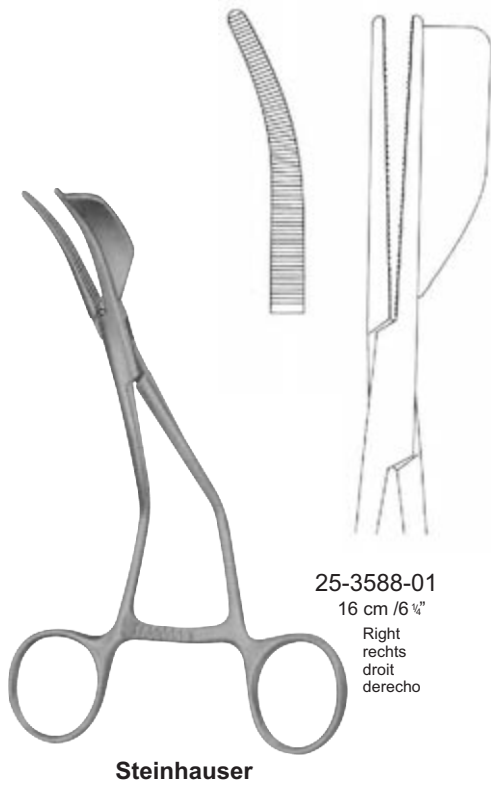
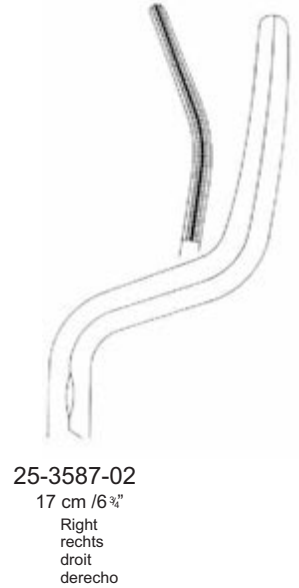
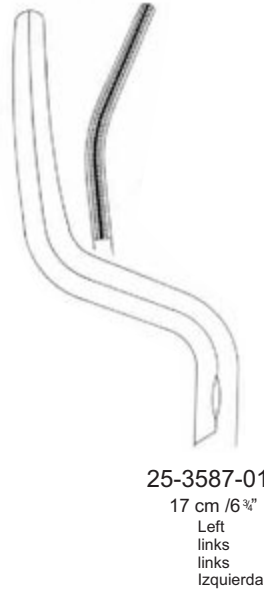

25-3588-01
16 cm / 6 1/4"
Right
rechts
droit
derecho



25-3588-02
16 cm / 6 1/4"
Left
links
links
Izquierda

Oral Maxillo Facial Surgery

Channel Retractors, Ramus Pusher,
Wir Introducer, Septal Osteotome, Duct Retractors
Channel-Reraktoren, Ramus Pusher,
Wir Introducer, Septal Osteotom, Duct Retraktoren

Rétracteurs Channel, Pusher Ramus,
Wir introducteur, ostéotomes septale, écarteurs de conduits
Los retractoros del canal, empujador Ramus,
Wir Introducitor, osteotomo septal, retractoros de ductos



25-3582-18
16.5 cm / 6 1/2"

Terry



25-3583-24
24 cm / 9 1/2"

Terry

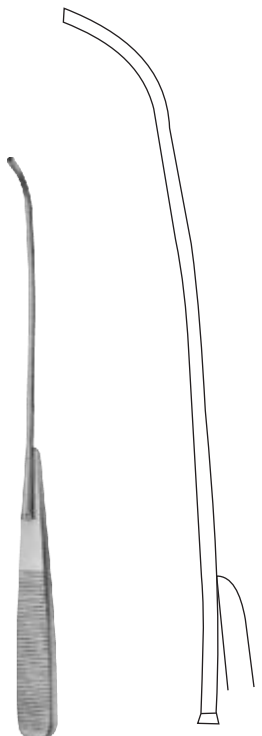

Terry

25-3584-17
17 cm / 6 3/4"



Terry

25-3585-19
19 cm / 7 1/2"



Terry

25-3586-00
14 cm / 5 1/2"



Terry

25-3586-01
15 cm / 6 "
Left
links
links
Izquierda



Terry

25-3586-02
15 cm / 6 "
Right
rechts
droit
derecho

Oral Maxillo Facial Surgery

Osteotomes ostéotomes
Osteotome osteotomos



25

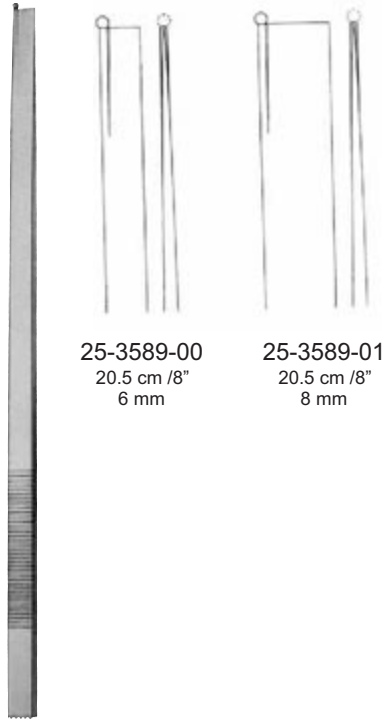

25-3589-00
20.5 cm / 8"
6 mm

25-3589-01
20.5 cm / 8"
8 mm

Bauer

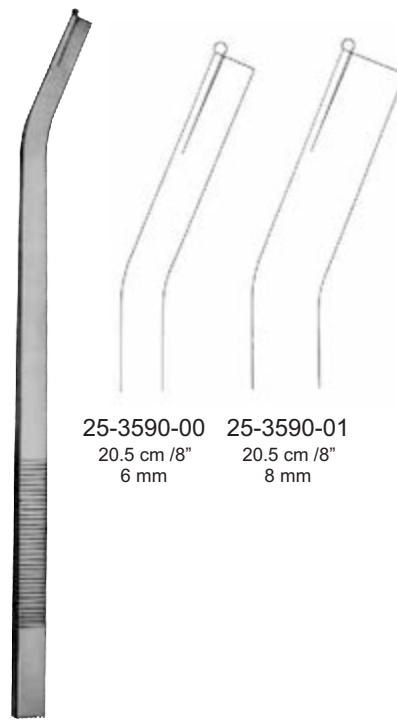

25-3590-00
20.5 cm / 8"
6 mm

25-3590-01
20.5 cm / 8"
8 mm

Bauer

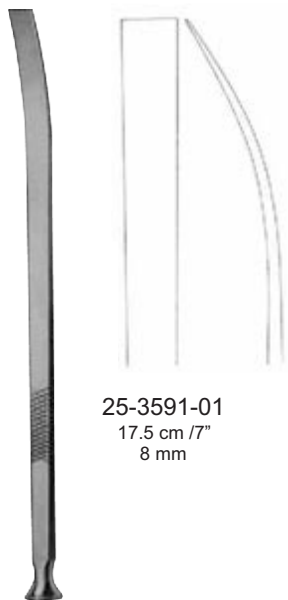

25-3591-01
17.5 cm / 7"
8 mm

Epker-Bauer

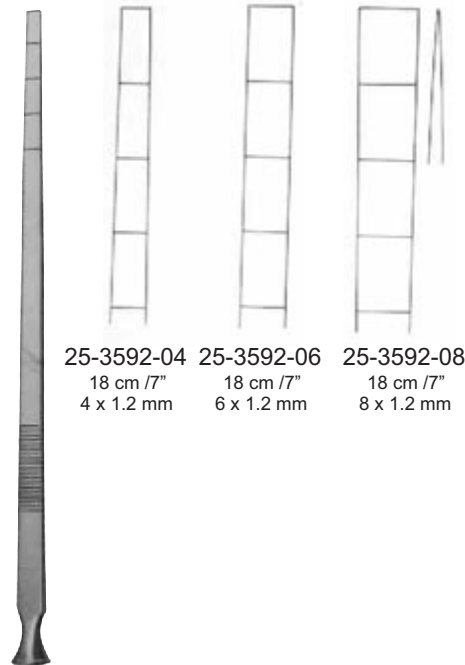

25-3592-04
18 cm / 7"
4 x 1.2 mm

25-3592-06
18 cm / 7"
6 x 1.2 mm

25-3592-08
18 cm / 7"
8 x 1.2 mm

Epker

Oral Maxillo Facial Surgery

Osteotomes
Osteotome

ostéotomes
osteotomos



Epker

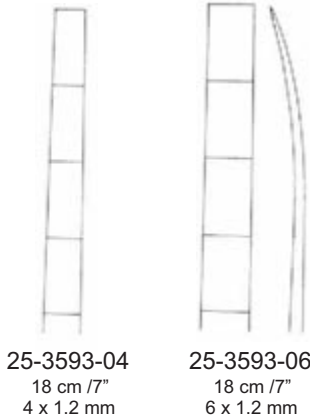

25-3593-04
18 cm / 7"
4 x 1.2 mm

25-3593-06
18 cm / 7"
6 x 1.2 mm



Epker

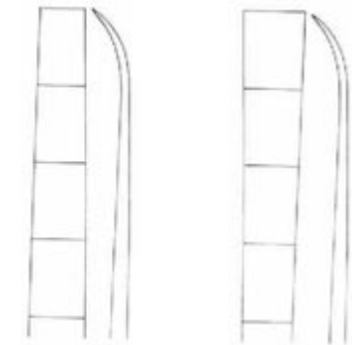

25-3594-06
18 cm / 7"
6 x 1.2 mm

25-3594-08
18 cm / 7"
8 x 1.2 mm



Steinhauser
Flexible

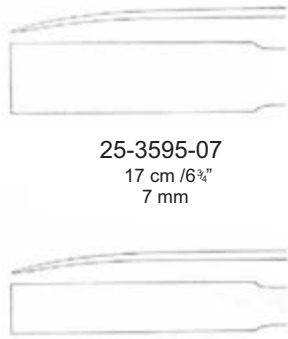

25-3595-07
17 cm / 6 3/4"
7 mm

25-3595-10
17 cm / 6 3/4"
10 mm



Steinhauser
Flexible

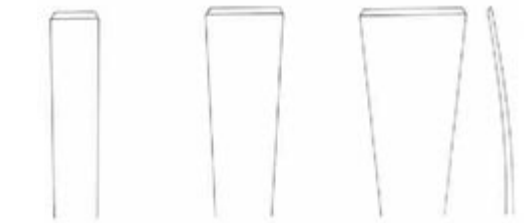

25-3596-07
19 cm / 6 1/2"
7 mm

25-3596-11
19 cm / 6 1/2"
11 mm

25-3596-15
19 cm / 6 1/2"
15 mm

Oral Maxillo Facial Surgery

Raspatories, Osteotomes
Raspatories, Osteotome

Raspatories, les ostéotomes
Raspatories, osteotomos

25



25-3597-16
16.5 cm / 6 1/2"
3 mm

Steinhauser



25-3598-05
18 cm / 7 1/2"
5 mm

Steinhauser



25-3598-08
18 cm / 7"
8 mm

Steinhauser



25-3599-06
23 cm / 9"
6 mm



25-3599-08
23 cm / 9"
8 mm

Wolford

Oral Maxillo Facial Surgery

Cleft Palate Instruments
Gaumenspalte Instruments

Instruments fente palatine
Instrumentos del paladar hendido



Salyer
25-3600-18
18.5 cm / 7³/₄"

Cleft Palate Hooklet long blade
Gaumenspalte Håkchen lange Klinge
Cleft Palate longue lame hroehure
Paladar Hendido hoja Hooklet largo



Salyer
25-3601-18
18.5 cm / 7³/₄"

Cleft Palate Hooklet long blade
Gaumenspalte Håkchen lange Klinge
Cleft Palate longue lame hroehure
Paladar Hendido hoja Hooklet largo



Salyer
25-3602-18
18 cm / 7"

Cleft Palate Dissector nasal
Gaumenspalte Dissector nasale
Fente palatine Dissector nasale
Paladar Hendido Dissector nasal



Salyer
25-3603-18
18 cm / 7"

Cleft Palate Dissector nasal
Gaumenspalte Dissector nasale
Fente palatine Dissector nasale
Paladar Hendido Dissector nasal



Salyer
25-3604-18
18 cm / 7"

Cleft Palate Instruments
Gaumenspalte Instruments
Instruments fente palatine
Instrumentos Paladar Hendido



Salyer
25-3605-18
18 cm / 7"

Cleft Palate Elevator
Gaumenspalte Aufzug
Ascenseur fente palatine
Ascensor Paladar Hendido



Salyer
25-3606-18
18 cm / 7"

Cleft Palate Elevator
Gaumenspalte Aufzug
Ascenseur fente palatine
Ascensor Paladar Hendido



Jaboma
25-3607-18
17 cm / 6³/₄"

Cleft Palate Periosteal
Gaumenspalte Periosteal
Périostique fente palatine
Periostótomo Paladar Hendido

Oral Maxillo Facial Surgery

Palatal Expander
Palatal Expander

palatine Expander
Expansor de paladar:

25



Turvey

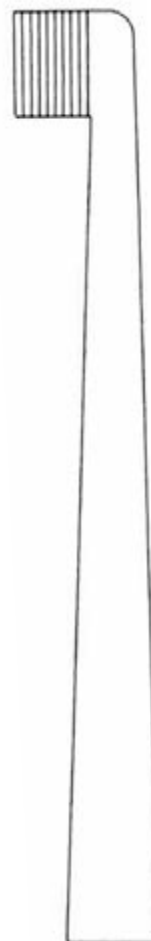

Salyer
25-3608-17
17 cm / 6³/₄"

A	PAGES #	B	PAGES #
ABDOMINAL RETRACTORS	181-190-193-194	BABCOCK	200-421
ABDOMINAL AND INTESTINAL SPATULAS	166	BABCOCK ATRAUMA	421
ADLERKREUTZ	89	BABCOCK (STANDARD)	421
ADSON BROWN	88	BABINSKY	243
ADSON BONE RONGEUR FORCEPS	312	BABY-ADSON	109
ADSON DISSECTING FORCEPS	46	BABY-ALLIS	420
ADSON DRESSING FORCEPS	82	BABY-BABCOCK	421
ADSON STANDARD FORCEPS	82	BABY-BALFOUR	188
ADSON DRILL GUIDE	322	BABY-BARRAQUER	493
ADSON DURA HOOKS	399	BABY-COLLIN	182
ADSON (SCISSORS)	46	BABY-CRILE	105
ADSON-FINE	46	BABY-CRILE-WOOD	220
ADSON HEMOSTATIC DISSECTING FORCEPS	109	BABY-DOYEN	423
ADSON LIGATURE	95	BABY-HEGEMANN	44
ADSON NASAL DRESSING FORCEPS	97	BABY-KOCHER	428
ADSON NEEDLE HOLDERS	217	BABY-LEXER (KNAPP)	40
ADSON PERIOSTEAL RASPATORIES	285	BABY-METZENBAUM	19-29
ADSON RETRACTORS	178-179-180	BABY-MIKULICZ	127
ADSON-STANDARD	82	BABY-MIXTER	118
ADSON SUCTION TUBES	252	BABY-OLSEN-HEGAR	217-228
ADSON TISSUE FORCEPS	88	BABY-OVERHOLT	114
ADLER	523	BABY-POOLE	253
AEBIL	54	BABY-ROUX	146
AFRICH	599	BABY-SATINSKY	350
ADAMS	609	BABY-SENN-MILLER	144
ASCH	603	BACKHAUS	128-524
AGRICOLA	475-495	BACON	309
ALDERDYCE	292	BAILEY	347
ALEXANDER - BONE CHISELS	268	BAILEY-BABY	347
ALEXANDER - PERIOSTEAL RASPATORIES	284	BAILEY-GIBBON	347
ALEXANDER - UTERINE BIOPSY FORCEPS	487	BAINBRIDGE	110-362
ALLEN	430	BAKES	44
ALLIS	420	BALLENGER - HAJEK	590
ALLIS-ADAIR	420	BALLENGER	588-593
ALLIS-ATRAUMA	420	BALFOUR	188-189-190
ALLISON	348	BALFOUR us-TYPE	190
ALLPORT	174	BALL AND SOCKET	129
ALM	174	BALLENTINE	122
ALEXANDER	487	BANDAGE SCISSORS	74
ALY	241	BANDAGE AND WIRE CUTTING SCISSORS	72
AMPUTATION KNIVES	09	BANE-HARTMANN	308
ANASTOMOSIS CLAMPS AND PEDICTRIC VASCULAR CLAMPS	379	BARBARA	555-556
ANDERSON-ADSON	178	BARD-PARKER	544
ANDREW-PYNCHONE	254	BARD-PARIIZER	544
ANIS	518	BARR	437
ARNEST	502	BARRAQUER	52-95-212-499-504-526-532-539-542
ARRUGA	210-211-213-227-493-542	BARRAQUER COLIBRI	493
ARRUGA - EYE SPECULAS	493	BARSKY	139
ARRUGA - NEEDLE HOLDER	542	BARTH	281
ATRAUMA	136	BAUER	640
ATRAUMATIC PHACO	506	BEAUPRE	95
ARROW SMITH	511	BEACHAM	475
ARNHEM	635	BECHERT	496
AUFRICHT	596-601	BECHERT-Mc PHERSON	500-529
ASCH	602	BECKMANN	180-604
AUSTIN	84-557	BECKMANN-ADSON	179
AUVARD	470	BECKMANN-EATON	181
AXHAUSEN	218-226	BEEBEE	77
AXENFELD	513-518	BEER	96-532
AXENFELD CURRETTES	517	BEESON	262
AYRE - CHEEK RETRACTORS	257		
AYRE - FISTULA HOOKS	482		
AYER - FORCEPS	534		

INDEX (ENGLISH)



	PAGES #		PAGES #
BELUCCI	175	BROCK	419
BENGOLEA	111	BRODIE	195
BENNETT	95-298	BROPHY	83-90
BENSAUDE	437	BROPHY (SULLIVAN)	38
BENSON	430	BROWN	89-214
BERGMANN	07-73-142-151-331-332	BRUNETTI (AUTOPSY KNIVES & CHISELS)	13
BERKE	534	BRUNNER	162-236-237-238-338-427
BERLINER	242	BRUNNER-FERROZALL	238
BERNHARD	129	BRUNS	74-274-276
BERTILLON	244	BRUNINGS	568-582-588-618
BESNIER	419	BRYANT	132
BEYER	310	BUCCI	552
BEYER ZAUFAL-JANSEN	313	BUCK	242-566-569-570-573
BIRCHER	300	BUCK-GRAMCKO	293
BILLEAU	571	BUELAU	259
BIRCHER-GANSKE	302	BUIE	123-196-441
BIRKETT	111	BULLDOG CLAMPS	354
BISHOP	616	BULLDOS FORCEPS	136
BISHOP-HARMON	499-525	BULLDOG HEMOSTATIC FORCEPS	101
BLADES FOR LAMINA SPREADORS	400	BUNGE	515
BLAKE	448	BURFORD	343
BLAYDES	501-531	BUSCH	48
BLOW PIPES & POST MORTEM SET	14-18	BUSHE	279
BLOUNT	153-158-298-299	BEYER	522
BLUMENTHAL	310		
BOHLER	313-316	C	
BONACCOLTO	526-531	CANAD-MODELL	300
BONE CHISELS	264-265-271	CARBON STEEL	543
BONE CURETTES	276-277-279-280-281	CAROLL	244-335
BONE DRILLS	320	CARREL	101
BONE FILES AND RASPS	282	CARTLIAGE KNIVES	11
BONE EYE SCISSORS	67	CARTON	457
BONE GOUGES	273	CASPER	155-401
BONE HOLDING CLAMPS	307	CASTANEDA	341-386
BONE HOLDING FORCEPS	301-306-307	CASTROVIEJO	16-54-56-201-202-211-212-528
BONE HOLDING FORCEPS SELF CENTRING	305	CASTROVIEJO (LACRIMAL INSTRUMENTS)	495-499-504-517-519
BONE LEVERS	293-294	CASTROVIEJO (SCISSORS)	540-541
BONE NAIL	330	CASTROVIEJO (NEEDLE HOLDER)	542
BONE SHEAR	75	CASTROVIEJO (BREAKERS)	543
BONN MODEL	538	CASTROVIEJO-KALT	210-542
BONNEY	83-93	CATLIN (AMPUTATION KNIVES)	09
BORES	508-510-511	CAUCHOIX	266
BOSE	174-415	CAWOOD-MINNESOTA	616
BOTTCHER	46	CERVICAL TRACTION TONGS	391
BOWDLER-HANRY'S	172	CHADWICK	68-80
BOWMAN	493-517	CHANDLER	298
BOWLES	241	CHAPUT	101
BOYNTON	211-227	CHARRIERE	319
BOZEMANN	134-222-239-471	CHAVALIER JACKSON	416
BOZEMANN-DOUGLAS	135	CHERON	134
BOZEMANN-FRITSCH	457	CHILD	240
BRAIN RETRACTOR	407	CHISEL	271
BRAND	108-334-336		
BRAUN	48-466-467-474-475-478-549		
BRAUN-STADLER	21-48		
BREISKY	470-545		
BRIAN AND ELEVATORS	397		
BRIDGE	112		
BRISTOW	297		

	PAGES #	D	PAGES #
CHISEL-CURVED	271	DAHIGREN	390
CHUCK HANDLE	544	DALE	357
CINELLI	594	DANDY	51-69-108-398
CITELLI	522-568	DARDIK	356
CITELLI BEYER	568	DARTIGUES	481
CLAYMAN	531	SASTOOR	519
CLITTLE	578	DAUBENSPECK	278
CLEVELAND	309-316	DAVIDSON	167
CLOTHING SCISSORS	75	DAVIDSON-ALEXANDER	284
PLASTER OF PARIS AND RIB SHEARS	75	DAVIS	394
CLOVIS VINCENT	308	DAVIS-BOYLE	612
CLOWARD	402-403	DEAN	79
COAKLY	260-604	DEAVER	26-164
COAPTATION	535	DEAVER GRIP-HANDLE	164
COBB	257-273-287-290	DE BAKEY	41-44-97-185-221-345-354-360-361
COHAN	528	DE BAKEY	362-363-364-365-366-367-372-374-377-378-379-380
COOK	494	DE BAKEY-BAHNSON	373
COLCLOUGH	410	DE BAKEY-BECK	379
COLLER-CRILE	106	DE BAKEY-FINE	221
COOLEY	167	DE BAKEY-MOSQUITO	355
COLLIER (NEEDLE HOLDER)	214	DE BAKEY-PEAN	376
COLLIN (SCALPEL HANDLE)	01	DE BAKEY-RANKIN	355
COLLIN	102-134-147-181-182-183-240-244-256	DE BAKEY-SATINSKY	351
COLLIN	460-481-545-549-619	DEITZ	508
COLLIN-DUVAL	92	DE LEE	545
COLLIN-HARTMANN	146	DE MARTEL-WOLFSON	435
COLLIN-LANDAU	460	DE VILBISS	390
COLLER-CRILE	106	DEAVER	26-164
COLLEY	359-381-382-383-389	DEAVER GRIP-HANDLE	164
COLLYER	545	DEMEL	329
COLLEY (COLLEY-BABY)	341-342	DENIS-BROWN	192
COLIBRI	535	DENHART	610
CONE	178	DERF	214-222
CONE (ADSON-BABY)	177	DERRA	379
CONNEL	256	DESCHAMPS	229-230-231
CONVERSE	220	DESCHAMPS-STANDARD	229
COOPER	233	DESJARDINS	447-448-449-450
COTTLE	21-50-586-589-591-592-596-599-600-601-603	DESMARRES	143-513-520-535
COTTLE-WALSHAM	602	DEYEN	36
COTTLE-NEIVERT	600	DE-WECKER	539
COTTON APPLICATORS	197-198	DIEFFENBACH (HEMOSTATIC FORCEPS)	101
CONVERSE	586-599	DIEFFENBACH (OPERATING KNIF)	06-07
CORYLLOS	163	DIETRICH	136-213-355
CRAFOORD	47-113-158	DINGMANN	170-171-301-614-628
CRAFOORD-SELLORS	113	DINGMANN MODIF	301
CRILE	105-137-143-218-388	DINGMANN-WILK	628
CRITCHETT	495	DISSECTING AND NEUROSURGICAL SCISSORS	68
CRILE-WOOD	217-220	DISSECTING AND TONSIL SCISSORS	46
CROWN SCISSORS	77	DISSECTING SETS	17
CRUTCHFIELD	391	DITTEL	455
CRUNWALD	565	DIXON-LOVELACE	110
CUSCO	459	DOCKHORN	168
CUSCO (SWISS PATTERN)	459	DOUBLE MARKER	510
CUSHING (DRESSING FORCEPS)	85-90	DOUGLAS	96-260
CUSHING	137-143-145-321-398	DOYEN	129-161-193-288-423-468-469-480-618
CUSHING-KOCHER	145	DOYEN-ATRAUMA	424
CUSHING-TAYLOR	85	DOYEN-ROCHARD	193
CZERNY	155-436-448-478	DOYEN-STILLE	161

INDEX (ENGLISH)



	PAGES #
DRESSING FORCEPS	81-83-384
DREW SMYTHE	457
DRILL GUIDE AND DURA PROTECTING FORCEPS	322
DUVAL	92
DURANTE	92
DUBOIS	35
DUNHILL	108
DUPLAY	131-475
DUPLEX	241
DUPUY-WEISS	232
DURA DISSECTORS	394-395
DURANTE	92
DURHAM	232
DUVAL	422
E	
EASTMAN	464
EAR SYRINGES	575
ECHLIN	315
EISELSBERG	71
ELEVATORS	291
ELCKEN-KILLIAN	605
ELSCHNIG	527
EMMETT	482
ENDARTERECTOMY	200
ENGEL	261
ENGL. MODELL	81-128
ENUCLEATION	538
EPSTEIN	280
EPKER	640-641
EPKER-BAUER	640
ERHARDT	535
ERMOLD	217
ERNEST	534
ESMARCH	73-261
EWALD	82
EWALD	88
EXTENSION BOWS	328
EXTRA ORAL RETRACTORS	620
EYE AND FINE SCISSORS	65-66-67
EYE DRESSING FORCEPS	525
EYE SCISSORS	66-67-68-537

F

	PAGES #
FAULKNER	531
FARABEUF	147-267-283-305
FARABEUF-COLLIN	283
FARABEUF-LAMBOTTE	306
FARRELL (FARRELL-LATHBURY)	197
FARRIS-SMITH	92-411
FARRIS-SMITH-KERRISON	408-409-587
FARRIOR	560
FAURE	125-126-484
FAVALORO	41
FEHLAND	427
FEILCHENFELD	94
FEIN	196
FERGUSON	27-122-251-302-451
FEASTER	531
FIACH	558
FINE	501-533
FINE THORNTON	506
FINE AND SPLINTER FORCEPS	91
FINE OPERATING SCISSORS	37
FINE SCISSORS	39-40
FINOCHIETTO	4 7-119-216-224-339-343
FINOCHIETTO-BABY	339
FINOCHIETTO-BABY-HAIGHT	341
FINOCHIETTO-BURFORD	340-344
FINSEN	174
FINSTERER	253
FLAP REPOSITOR	496
FLACH	558
FLEXIBLE SHAFT	488
FISCHER	334
FISH	195
FISTULA KNIVES	08
FOERSTER	135
FOMON	21-50-586-594-597-598-599-600
FOX	419
FRANZ	194
FRANKFELDT	198
FRAZIER	137-186-251-252
FREER	520-588-589-591
FRENCH	561
FRIEDMANN	302
FRIEDMANN-DELICATE	309
FRITSCH	161
FRYKHOLM	315
FUCHSIG	110
FUELLER	416
FUKASAKU	498-507

G	PAGES #	H	PAGES #
GRAEFE	526	HABERER	166-434
GALL DUCT CLAMPS	123	HAFMANN THORNTON	506
GARLAND	123	HAGENBARTH	240
GASS	521	HAGLUND-STILLE	262
GAUSS	548	HAIGHT	342
GALLAHER	596	HAJEK	413-587
GELLHORN	484	HAJEK-KOFLER	413-587
GELPI	184	HAKANSSON	310
GERALD	84-90	HALFRICH-BIER	319
GERBODE	389	HALLE	50-279-399
GERZOG	333	HALSEY	214-220
GIERTZ-STILLE	338	HALSTEAD-MOSQUITO	103-104
GIGLI	390-518	HAMILTON BABY	257
GILLIES	89-137-172-218-228-419-628	HANK	473
GILLIES SLIM	218-228	HARGIS	627-633-636
GIL-VERNET	140	HARKEN	350-368
GILLS VANNAS	539	HARMS	499-517-528
GILLS-WELSH VANNAS	539	HARMS-JAFE	499-530
GIMINI	117	HARRINGTON-BABY	164
GIRARD	528	HARTMANN	103-309-524
GLICK	337	HARTMANN	559-561-562-563-564-566-567-571-580-581-617
GLOBE FIXATION	506	HARTMANN HOFFMANN	567
GLOVER	351-353-378	HARTMANN-HALLE	576
GLUCK	75	HARTMANN NOYES	567
GOELET	146	HARTMANN-WULLSTEIN	567
GOLDSTEIN	493	HARTMANN WEINGATNER	567
GOLDMAN-FOX	51-78	HARVEY	72
GOLDSMITH (THUDICHUM)	576	HASTED	524
GOOD	47	HAUTANT	264-266
GOSSET	185-186	HAYES	426
GRADLE	95	HAYES PROVIS	457
GRAEFE	68-91-138-494-520	HEAD LAMPS	243
GRAETHER	514	HEANEY	121-165-215
GRAHAM	399	HEANEY-BALLENTINE	122
GRANDON	511	HEANEY-SLIM	121
GRAVE	461	HEATH (LIGATURE SCISSORS)	71-332
GRAVE (STANDARD)	461	HEATH	535
GRAY	447	HEBRA	418-515
GRAZIL	26	HEES	525
GREEN	158-527	HEGAR	215-472
GREEN-ARMYTAGE	547	HEGAR-BAUMGARTNER	214-221
GREGOIRE	422	HEGAR-VASCULAR	223
GREGORY	352-358	HEGEMANN (DIETHRICH)	44
GREGORY-SOFT	352	HEISTER	610
GRONINGEN	398	HEISS	116
GROSS-MAIER	131	HEMOSTATIC FORCEPS	102-104
GRUNWALD	85	HENLEY	177-406
GRUNWALD (JANSON)	580	HENNER (LEMPERT)	176
GUILLEN	605	HENNING	262
GUM AND NAIL SCISSORS	80	HENRY	95
GUM SCISSORS	78	HEOSEL	156
GUTHRIE (WOUND AND NERVE HOOKS)	138	HEPP-SCHIEDEL	212
GUTTMANN	458	HERRICK	445
GUYON	444-456	HERTZLER	186
		HEY	404
		HEY GROVES	303
		HEYMANN	21-50-581
		HEYWOOD-SMITH	441

INDEX (ENGLISH)



PAGES :-

HIBBS	165-272
HIRSCHMANN	437
HOCKY KNIFE	507
HOFFMANN	130
HOFFER	509
HOHMANN	294-295
HOHMANN-ALDINGER	296
HOHMANN-WILLIGER	292
HOIZHEIMER	175
HOKE	269
HOLSHER	396
HOLTH	523
HOPKINS	261
HORSLEY	396
HOSEL	227
HOUSE	558
HUNTER	593
HUNTER RECOTOMY FORCEPS	322
HUNTER	15-236
HUMBY	415
HUNT	534
HOZLBACH	123

J

JACKSON	
JACOBSON	
JACOBSON-ADSON	
JACOBSON-HALSTEAD	
JABOMA	
JANSEN	
JANSEN-DEEP	
JANSEN (GRUENWALD)	
JAMESON	
JAVID	
JAWS DEPTH	
JEFFE	
JEES	
JENNINGE	
JETER-VAN SICKELS	
JHONES	
JOBOMA	
JOBSON-HORNE	
JOHNS-HOPKINS	
JOSEPH	
JOSEPH-MASING	
JUDD-ALLIS	
JUDD-MASSON	
JUDET	
JEWELERS	

PAGES :-

	139-142-463
	58-202-213-281-477
	82-109
	103
	643
	97-175-281-284-310-312
	175
	97
	20-38-38-216-565-570
	358
	179
	513-540
	526
	614-615
	632
	128-524
	98
	197
	101-114
	40-520-586-589-591-595-596-599-600
	591
	421
	453-454
	266
	529-535

I

IMPECTOR	264
INGE	403
INTESTINAL TISSUE AND ORGAN GRASING FORCEPS	422
INTIMA SPATULA, VASCULAR DISSECTORS	387
IOWA	477
IOL INSERTIN FORCEPS	501
IRIDECTOMY SCISSORS	52-53-54
IRIS FORCEPS	525
IRIS SCISSORS	537
INTRA ORAL RETRACTORS	621-622-623
ISRAEL	152
ITERSON	142
IVES-FANSLER	438

K

KADER	166
KALMORGEN	467
KALT	210-212-542
KALT-ARRUGA	210
KANSAS	516
KANTRIWITZ	113
KATZIN	55-541
KATZIN-BARRAQUER	55
KAZANJIAN	317-585
KELSEY-FRY	173
KEEN	632
KELMAN-Mc PHERSON	500-530
KELLY (SCISSORS)	36
KELLY (FORCEPS)	104-112
KELLY (RETRACTORS)	159-160-163
KELLEY	521
KERN	303
KERRISON	523-568
KEVORKIAN	486
KEY	292
KEYES	419
KIELLAND	546
KILLIAN	577-581-590-593

INDEX (ENGLISH)



	PAGES #		PAGES #
LOWER	117	MAYO-HEGAR	215-220-221-223-227
LOWMAN	307	MAYO-ROBSON, MAYO-ROBSON ATRAUMA	425
LOWMAN-HOGLUND	307	MAYO-RYDER	223
LUBET-BARBON	580	MAYO-STTILE	19-28
LUC	582	MAYO-NOBLE	29
LUCAE	97-333-562-563-572-573	McDONALD	292
LUER	143-312-416	Mc CULLAUGH	526
LUER-KOERTE	450	McGIVNEY	443
LUKENS	139	McGEE	553-556
LUNTZ-DODICK	521	Mc GUIRE	539
LUNG SPATULAS	348	Mc PHERSON	500-530-535-543
		Mc PHERSON WESTCOTT	500-530-535-540
		MCKENZIE	321-392
		MCKENTY	589-590
		MCLVOR	613
		MC. QUIGG-MIXTER	119
		MCLNDOE	43-82-316
		MEAD	310-333
		MEASURING INSTRUMENTS	244
		MEEKER	117
		MELLINGER	494
		MELLINGER AXENFELD	493-494
		MELLINGER BEARD	494
		MENISUCS RETRACTOR	299
		MENDEZ	508
		MERCEDES-RETRACTOR	346
		MERSHON	173-631
		METZ	625
		METAL CATHETERS AND INTRODUCERS	456
		METZENBAUM	19-30-31-32-33-227
		METZENBAUM-FINE	19-29-30-31-32-33-227
		METZENBAUM-FINO	33-34
		MEYERDING	142-165-184
		M. G. H	216
		MEYHOEFER	515
		MICHEL	240
		MICHEL	240
		MICHEL MODIF	240
		MICRO-ADSON	82-88
		MICRO DISSECTING FORCEPS	100
		MICRO DRESSING FORCEPS	99
		MICRO FORCEPS	84
		MICRO EAR FORCEPS	550-551
		MICRO-HOE AND EPI-PEELER	496
		MICRO-MOSQUITO	103
		MICRO NEEDLE HOLDER	203-204-205-206-207-208-209-504
		MICRO SCISSORS	57-58-59-60-61-62-63-64
		MICRO RYDER	223
		MIDDELDORPF	158-159
		MIDDLETON-JANSON	585
		MIGIVNEY	442
		MIKULICZ	126-127-162
		MILLER	137
		MILLIGAN	177-393
		MILLIN	255-452-453
		MILLS	69
		MINI-FRIEDMANN	308
		MINI-GEMINI	118
		MINI-HOHMANN	293

M

MACEVEN	267
MAGILL	255-256-257
MAGAHARA	498
MAGILL (NASAL)	257
MALTZ	596
MALLETS	331-332-333
MALEABLE BLACK	252
MALONEY	503
MANGIAGALLI	469
MARKHAM-MEYERDING	185
MARKWALDER	316
MARQUARDT	314
MARTEL	124-390
MARTIN	162-302-545
MARTIN-CARTILAGE	43
MARTINI	281
MARTEL	124
MASING	591
MASKET	503-532
MASSON	216-224
MASTIN	417
MATHIEU	147-219-225-227-436-458-468
MATHIEU-KOCHER	226
MATHIEU-RYDER	225
MATSON	286
MATZENAUER	466
MAURER COLLIN	76
MAUNDER	609
MAYFIELD	313
MAYO	19-33-92
MAYO (OPERATING & DISSECTING SCISSORS)	28 -451
MAYO-ADAMS	183
MAYO-BLAKE	448
MAYO-COLLIN	147
MAYO-GUYON	445

INDEX (ENGLISH)



	PAGES #
PATTIGROVE	507
PAYR	236
PAYR (PAYR-BABY)	432
PEAN	102 107-259
PEDERSON	462
PEERS-BERTRAM	128
PEET	94
PELKMANN	131
PELTSON	196
PENFIELD	394
PENNINGTON	102-590
PERCUSSION HAMMERS	242
PERCY	305
PERTHES	322
PERINEUM EPISIOTOMY SCISSORS	49
PERIOSTEAL RASPATORIES	285-288-289-290
PERIPHERAL VASCULAR CLAMPS	361
PERITONEAL CLAMP AND HYSTERECTOMY FORCEPS	126
PHANEUF	122
PHACO ACCESSORIES	512
PIERCE	260-590
PIERES	528
PIERES-HOSKIN	536
PIFFARD	418
PIGTAIL	517
PINARD	241
PITHA	609
PLASTIC SURGERY	20
PLESTER	175-252-554
PLESTER-SPATULAS	196
POTTS-DE MARTEL	69
POIRIOER	265
POIRIOER TRIUAT	265
POLLOSON	163
POOLE	253
POLACK	528
POST MORTEM SET	14-18
POTTS	375
POTTS-SMITH (VASCULAR SCISSORS)	22-41-42-43
POSTTS-SMITH (DRESSING & TISSUE FORCEPS)	85-90
POLITZER	573
PRATT	101-196-436-473
PRE CHOPPER	502-534
PRE CHOPPER FOR SOFT CATARACTS	502-534
PRICE-THOMAS	349
PRINCE	46
PROBES	195-196
PROVIDENCE	106
PROVIS INTRA	457
PUTTI	282

Q

QUEEN SQAURE	243
QUERVAIN	291
QUINBY	78
QUIRE	566

R

	PAGES #
RABINER	243
RALK	94-320
RAMSAY	92
RAMUS	169
RANDALL	446
RANEY	392
RANPLEY	135
RANGELL-DAVIS	144
RAZOR BLADE BREAKERS	16
RECTAL SPECULAS	436
RECAMIER	490
REINER	261
RESANO	426
RETINAL SPATULA	505
RETRACTORS	140-153-174
RETRACTORS AND BONE RETRACTORS	148-149-150
RETRACTORS AND MAXILLOFACIAL SURGERY	168-170-172
RETRACTORS AND MENISCUS RETRACTORS	158
REVERDIN	166-234-235
REYNOLDS	20-22-38
RIB SHEARS	337
RICARD	184
RICHARDSON	159-160
RICHARDSON-EASTMAN	159
RICHTER	27-184
RICHTER-HEATH	240
RIGBY	185
RITTER-HALLE	605
RIZZUTI	514
ROBB	387
ROBERTS	112
ROCHARD	193
ROCHESTER-CARMALT	108
ROCHERTER-PEAN	107
ROEDER	129
ROGER	121-514-591
ROLLET	513
ROLE	517
ROSE	143
ROSER-KONIG	610
ROSEN	498-554-555-558
ROSENBAUM-DREWS	514
ROSS	167
ROTTGEN-RUSKIN	314
ROTUNDA HOSPITAL	457
ROWE	631-634
ROUX	146
FUBIN	592-602
RUDD	442
RUMEL	114
RUMEL-BELMONT	388
RUSKIN	313
RUSKIN-LISTON	317
RUSS. MODELL	92
RYDER	223
RYDEL-SEIFFERT	563

INDEX (ENGLISH)

S

	PAGES #
SAALFELD	418
SACHS	393-397-399
SAKAMOTO	633
SALYER	633
SALYER (CLAFT PALATE INSTRUMENTS)	643
SALENIUS	300
SANDERS-BROWN	173
SANTULLI	352
SANVENERO	40
SAENGER	547
SAROT	113-216-223
SATINSKY	43-350-369
SATTEERLEE	319
SAUER	493
SAUERBRUCH	154-163-315-338
SAUERBRUCH -FREY	338
SAYFFERT	462
SCALPEL HANDLES	01-02-03
SCHADEL	128
SCHEDE	277
SCHANZ	330
SCHAMBERG	418
SCHINDLER	126
SCHINK (SKIN GRAFTING KNIVES)	15
SCHMID	200
SCHMIDT-RIMPLER	526
SCHMIEDEN	233-238
SCHMIEDEN-DICK	233
SCHMIEDEN-PAYR	238
SCHNEIDER	284
SCHNEIDER-SAUERBRUCH	284
SCHNIDT	111
SCHOEMAKER-LOTH	71
SCHOENBORN	415
SCHRODER	475-476
SCHUBERT	484-485
SCHUCHARDT	625
SCHUKNECHT	72-554
SCHUMACHER	48-296-486-488
SCHWARTZ	136
SCOVILLE	187-396
SCOVILLE-HAVERFIELD	187
SCOVILLE-RICHTER	187
SCUDDER	423
SCUDDER / SUDDER-ATRAUME	433
SEBILEAU	292
SEDILLOT	283
SEGAND	480
SEGOND	126
SEGOND-LANDAU	126
SELLHEIM	548
SELDIN	284
SELLORS	347
SEMB	288-304-311-317-349
SEMKEN (DRESSING & TISSUE FORCEPS)	82-89
SEMM	191
SENN-GREEN	144
SENN-MILLER	144
SERREFINE	524

SEUTIN	75
SEXTON	573
SHAMBAUGH	557
SHAPLEIGH	569
SHEA	557-623
SHORTBENT	70
SIEBOLD	20-34-36
SILIA AND COVER GLASS FORCEPS	96
SILVER	595
SIMS	20-34-35-436-463-474-489
SIMS-MAIER	131
SIMON (PISTULA KNIVES)	08
SIMON	161-278-482-489
SIMPSON	546
SIMPSON BRAUN	546
SIMPSON LUIKERT	546
SIMPSON SMITH	497-530
SIMSLIFT CURETTES	607-608
SKELLEN	476
SMILLIE	299-300
SMITH	72
SMITH (SAGITTAL SPLIT SEPARATORS,RAMUS)	637
SMITH-BULE	437
SMITH (MOD. U.S.A)	74
SMITH-PETERSON	269-314
SMITHWICK	398
SOERESSEN-HEIN	170
SOMER	481
SPACKMANN	457
SPARE BLADES	15
SPENCER	70-538
SPENCER-FINE	70
SPENCER-WELLS	120
SPINAL	280
SPINA-NASALIS	169
SPIVEY	514
SPLINTER FORCEPS	94
SPRATT	276
STANDARD-ADSON	88
STANDARD (DRESSING & TISSUE FORCEPS)	81-86-87
STANDARD (GUM AND NAIL SCISSORS)	80
STANDARD (NELSON)	258
STANDARD (OPERATING & FINE SCISSORS)	23-24-39
STACKE	195
STEINHAUSER	628-629-632-635
STEINHAUSER (MYLOHYOLD MUSCLE AND RAMUS CLAMPS)	639
STEINHAUSER (OSTEOTOMES)	641-642
STEINMANN	334-335
STEINERT	501-533
STERN-GILLS	539
STERNBERG	256-615
STEVENS	21-67-210-538-543
STEVENSON	495
STILLE	75-76-81-263-272-315-321-445
STILLE-BARRAYA	93

INDEX (ENGLISH)



	PAGES #		PAGES #
STILLE-LISTON	317	TREPHINE ALCOHOL WEL	496
STILLE-LUER	311	TREPLE MARKER	510
STILLE-RUSKIN	315	TROCARS	258
ST. MARKS	157	TROELTSCH	97-580
STOCKMANN	458	TROELTSCH (WILDE)	97-565
STONE	87	TROUSSEAU	415
STRANDELL-STILLE	145	TROUSSEAU-BABY	415
STRATTE	224	TROUTMAN-BARRAQUER	54
STRAUSS	458	TROUTMAN	55
STRULLY	69	TROUTMAN CASTROVIEJO	541
STRUEMPEL	567	TROUTHMAN-LLOBERA	526
STRUYCKEN	584	TROUTMAN-CASTROVIEJO	56
SUCTION TUBES	251	TUBBA	389
SULLIVAN	79	TUBING FORCEPS	130
SUPERCUT SCISSORS	19-20-22	TUEBINGEN	162
SWEDISH PAERN	223	TUEBINGER-MODELL	176
		TUFFIER	101-161-166-340-344
		TUNNELING FORCEPS	133
		TURNER WARWICK	194
		TURVEY	644
		TYING	530
T		U	
TABB	554	UBIRE-STERM	539
TAKAHSHI	583	UCKERMANN	197-415
TAYLOR	83-89-187-242-299	ULRICH (PISTULA KNIVES)	08
TARNIER	548-549	ULRICH	132-303-467
TEALE	476	UNIVERSAL SCISSORS	51-71-72
TENDON SEIZING INSTRUMENTS	334-335	UNIVERSAL	197-258
TENNANT	513-530	UNNA	418
TERRY	606-638-639	UROLOGY INTRODUCERS	458
TESSIER	170-172	URERINE PULYPUS FORCEPS	479
THIERSCH	15	UTERINE CURETTES	491
THOMAS-ALLIS	420	UTERINE DILATORS	473
THOMAS GAYLOR	485	UTERINE TENACULUM FORCEPS	478
THOMSON-WALKER	454	UTILITY	525
THORNTON	506-509	UTRATA	503-532-533
TIECK-HALLE	577		
TISSUE FORCEPS	86-87-88		
TISSUE GRASPING AND WATCHMAKERS FORCEPS	93		
TOBOLD	256-617		
TOENNIS	46-117-219-226-393-399		
TOHOKU	128		
TONNIS	46		
TONSIL AND ENTEROTOMY SCISSORS 47			
TOWEL FORCEPS	128		
TOWNLEY	244		
TOYNBEE	559		
TRACHEA RETRACTORS	142		
TRAUBE	242		
TRAVERS	179		
TRELAT	460		
TREUBNAN-CHRIS (RAZOR BLADE BREAKERS)	16		
TREVES	87		
TREPHINE ALCOHOL WEL	496		

V

	PAGES #		PAGES #
VAGINAL SPECULAS	462-466-467	WILDER	518
VAN BUREN	301-455	WIEN	239
VANNAS	53-539	WIENER	597
VAN DOREN	485-486	WIEDER	617
VANNAS MOD,TUBINGEN	53	WILLS HOSPITAL	518-526
VARICOSE VEIN PROBE SET	199	WILLIAMS	421-494
VASCULAR SCISSORS	45	WILLIGER	277-281-284-285-291-332
VERBRUGGE	304	WILMER	68
VERBRUGGE-MULLER	294	WINTER	547
VIDAL	419	WIRE CUTTING PLIERS	325-326-327
VIRCHOW (POST MORTEM)	10	WIRE SEIZING FORCPS	323-324
VIRCHOW (CARTILAGE KNIVES)	11	WRIGLEY	546
VIRCHOW (AUTOPSY KNIVES)	12	WOLF	263-419
VOLKMANN	142-148-149-275-278	WOLFORD	633
VOLTOLINI	576	WOLFORD (OSTEOTOMES)	642
		WOUND AND NERVE HOOKS	138
		WOUND AND TRACHEA RETRACTORS	141
		WULLSTEIN	552-554

W

WACHENFELDT	240
WAGENER	572
WAGNER (FINE OPERATING SCISSORS)	20-37-290
WALB	10
WALDMANN	48
WALDAU	526
WALLEIX	474
WALTER	592-594
WALTER-CARMALT	94
WALTON	39
WANGENSTEEN	85-216-224
WARTENBERG	241
WASSMUND	152
WATSON-CHEYNE	195-292
WATSON-WILLIAMS	583
WAUGH (DRESSING & TISSUE FORCEPS)	83-90
WEBER	241-367
WEBER-LOCK	571
WEBSTER	214-222
WECKER	52
WEISS	492-495
WEITLANER	176-178
WEITLANER-BABY	177
WEITLANER-WULLSTEIN	176
WELLER	34
WEIL	583
WEIL-BLACKESLEY	584
WELLET-MARTEL	548
WERTHEIM	35-124-125-127
WERTHEIM-CULLEN	124
WESTCOTT	540
WEST	520
WELLS	516
WICKSTROEM	119
WILDER	518

Y

YANKAUER	254-255-291
YANKAUER UNIVERSAL	255
YASARGIL	203-205-251-407-414
YEOMAN	440
YEOMAN (TURRELL)	440
YOUNG	234-256-452-619

Z

ZAUFAL	571
ZENKER	114-165
ZIEGLER	96-517-532
ZWEIFEL	123-226
ZOLLNER	560
ZIELKE 272	

INHALTSVERZEICHNIS (DEUTSCH)



A	PAGES #		PAGES #
Bauchdeckenhalter	181-190-193-194	AXENFELD	513-518
Bauch-und DARM SCHAUFEL	166	AXENFELD CURRETTES	517
ADLERKREUTZ	89	Ayre - Wangenhalter	257
ADSON BROWN	88	AYRE - Fistel HAKEN	482
ADSON BONE Hohlmeißelzange	312	Ayer - PINZETTE	534
ADSON Dissektionszangen	46		
ADSON Kornzange	82		
ADSON STANDARD PINZETTE	82		
ADSON Drill Guide	322		
ADSON DURA HAKEN	399		
ADSON (Schere)	46		
Adson-FINE	46		
ADSON hämostatischen Dissektionszangen	109		
ADSON BLATTSCHRAUBE	95		
ADSON Tupferzange	97		
ADSON NADELHALTER	217		
ADSON periostale Raspatories	285		
ADSON RETRAKTOREN	178-179-180		
Adson-STANDARD	82		
ADSON Saugrohre	252		
ADSON chirurgische Pinzette	88		
ADLER	523		
AEBIL	54		
AFRICH	599		
ADAMS	609		
ASCH	603		
Aufricht	596-601		
AGRICOLA	475-495		
ALDERDYCE	292		
ALEXANDER-Knochenmeißeln	268		
ALEXANDER - periostalen Raspatories	284		
ALEXANDER - uterine BIOPSIEZANGEN	487		
ALLEN	430		
ALLIS	420		
ALLIS-ADAIR	420		
ALLIS-ATRAUMA	420		
ALLISON	348		
ALLPORT	174		
ALM	174		
ALEXANDER	487		
ALY	241		
AMPUTATION MESSER	09		
ANASTOMOSE KLAMMERN UND PEDICTRIC GEFÄSSKLEMMEN	379		
ANDERSON-ADSON	178		
Andrew- PYNCHONE	254		
ANIS	518		
Arnest	502		
ARRUGA	210-211-213-227-493-542		
ARRUGA - EYE SPECULAS	493		
ARRUGA - Nadelhalter	542		
ATRAUMA	136		
Atraumatische PHACO	506		
ARROW SMITH	511		
ARNHEIM	635		
AUFRICHT	596-601		
ASCH	602		
AUSTIN	84-557		
AUVARD	470		
Axhausen	218-226		
		B	
		BABCOCK	200-421
		BABCOCK Atrauma	421
		BABCOCK (STANDARD)	421
		Babinsky	243
		Adson BABY	109
		BABY ALLIS	420
		BABCOCK BABY	421
		BALFOUR BABY	188
		BABY-BARRAQUER	493
		BABY COLLIN	182
		Crile BABY	105
		BABY-WOOD Crile	220
		DOYEN BABY	423
		Hegemann BABY	44
		BABY-KOCHER	428
		BABY Lexer (KNAPP)	40
		Metzenbaum BABY	19-29
		Mikulicz BABY	127
		MIXTER BABY	118
		BABY-HEGAR OLSEN	217-228
		Overholt BABY	114
		BABY POOLE	253
		BABY-ROUX	146
		Satinsky BABY	350
		SENN-MILLER BABY	144
		Backhaus	128-524
		BACON	309
		BAILEY	347
		BABY BAILEY	347
		BAILEY- GIBBON	347
		BAINBRIDGE	110-362
		Bakes	44
		BALLENGER - HAJEK	590
		BALLENGER	588-593
		BALFOUR	188-189-190
		BALFOUR us-TYPE	190
		BALL AND SOCKET	129
		Ballentine	122
		BANDAGE SCISSORS	74
		AND WIRE CUTTING SCISSORS BANDAGE	72
		BANE-HARTMANN	308
		BARBARA	555-556
		BARD-PARKER	544
		BARD-PARIIZER	544
		BARR	437
		BARRAQUER	52-95-212-499-504-526-532-539-542
		BARRAQUER COLIBRI	493
		Barsky	139

B

BARTH	281
BAUER	640
Belucci	175
Bengolea	111
BENNETT	95-298
Bensaude	437
BENSOM	430
BERGMANN	07-73-142-151-331-332
BERKE	534
BERLINER	242
BERNHARD	129
Bertillon	244
BEAUPRE	95
Beacham	475
BECHERT	496
BECHERT-Mc PHERSON	500-529
BECKMANN	180-604
BECKMANN- Adson	179
BECKMANN- EATON	181
BEEBEE	77
BEER	96-532
Beeson	262
BESNIER	419
BEYER	310
BEYER Zaufal JANSEN	313
BIRCHER	300
BILLEAU	571
Bircher-GANSKE	302
BIRKETT	111
BISHOP	616
BISHOP-HARMON	499-525
MESSER FÜR LAMINA SPREADORS	400
BLAKE	448
BLAYDES	501-531
Blasrohre & FLEISCHUNTERSUCHUNG SET	14-18
BLOUNT	153-158-298-299
BLUMENTHAL	310
BOHLER	313-316
BONACCOLTO	526-531
Knochenmeißeln	264-265-271
Resektionslöffel	276-277-279-280-281
Knochenbohrer	320
BONE Feilen und Raspeln	282
BONE Augenschere	67
BONE bohrt	273
BONE Halteklammern	307
Knochenhaltezange	301-306-307
Knochenhaltezange SELF ZENTRIEREN	305
BONE HEBEL	293-294
Knochnagel	330
BONE SHEAR	75
BONN MODELL	538
BONNEY	83-93
BOHRUNGEN	508-510-511
BOSE	174-415
BÖTTCHER	46
Bowdler-Harry'S	172
BOWMAN	493-517
BOWLES	241

BOYNTON	211-227
BOZEMANN	134-222-239-471
BOZEMANN DOUGLAS	135
BOZEMANN FRITSCH-	457
BRAIN RETRAKTOR	407
BRAND	108-334-336
BRAUN	48-466-467-474-475-478-549
BRAUN-Stadler	21-48
Breisky	470-545
BRIAN und Aufzüge	397
Brücke	112
BRISTOW	297
BROCK	419
Brodie	195
BROPHY	83-90
BROPHY (Sullivan)	38
BROWN	89-214
Brunetti (Autopsieskalpelle & Meißel)	13
BRUNNER	162-236-237-238-338-427
BRUNNER-FERROZALL	238
BRUNS	74-274-276
Brünings	568-582-588-618
BRYANT	132
BUCCI	552
BUCK	242-566-569-570-573
Buck-Gramcko	293
BUELAU	259
Buie	123-196-441
Bulldogklemmen	354
BULLDOS PINZETTE	136
BULLDOG Arterienklemmen	101
BUNGE	515
BURFORD	343
BUSCH	48
Bushe	279
BEYER	522

C

CANAD-MODELL	300
C-STAHL	543
Caroll	244-335
CARREL	101
CARTLIAGE Messer	11
KARTON	457
CASPER	155-401
CATANEDA	341-386
CASTROVIEJO	16-54-56-201-202-211-212-528
CASTROVIEJO (Tränendrüse INSTRUMENTS)	495-499-504-517-519
CASTROVIEJO (Schere)	540-541
CASTROVIEJO (Nadelhalter)	542
CASTROVIEJO (AUFBRUCH)	543
CASTROVIEJO-KALT	210-542
Catlin (AMPUTATION MESSER)	09
CAUCHOIX	266
Cawood-Minnesota	616
Halswirbeltraktionsgerät TONGS	391
CHADWICK	68-80
CHANDLER	298

INHALTSVERZEICHNIS (DEUTSCH)



	PAGES #		PAGES #
CHAPUT	101	Cushing (Kornzangen)	85-90
CHARRIERE	319	CUSHING	137-143-145-321-398
Chavalier JACKSON	416	CUSHING-Kocher	145
CHERON	134	CUSHING-TAYLOR	85
KIND	240	CZERNY	155-436-448-478
CHISEL	271		
Meißel-CURVED	271	D	
CHUCK HANDLE	544	DAHIGREN	390
CINELLI	594	DALE	357
Citelli	522-568	DANDY	51-69-108-398
Citelli BEYER	568	DARDIK	356
Clayman	531	Dartigues	481
CLTTLE	578	SASTOOR	519
CLEVELAND	309-316	DAUBENSPECK	278
KLEIDUNG SCHERE	75	DAVIDSON	167
Gips und RIB SCHEREN	75	DAVIDSON-ALEXANDER	284
CLOVIS VINCENT	308	DAVIS	394
Cloward	402-403	DAVIS-BOYLE	612
COAKLY	260-604	Dean	79
Koaptation	535	Deaver	26-164
COBB	257-273-287-290	Deaver GRIP-GRIFF	164
Cohan	528	De Bakey	41-44-97-185-221-345-354-360-361
COOK	494	De Bakey	362-363-364-365-366-367-372-374-377-378-379-380
Colclough	410	De Bakey-Bahnson	373
COLLER-Crile	106	De Bakey BECK	379
COOLEY	167	De Bakey-FINE	221
Collier (Nadelhalter)	214	De Bakey-MOSQUITO	355
Collin (Skalpellgriff)	01	De Bakey-SCHEN	376
COLLIN	102-134-147-181-182-183-240-244-256	De Bakey-Rankin	355
COLLIN	460-481-545-549-619	De Bakey-Satinsky	351
Collin-Duval	92	Deitz	508
Collin-Hartmann	146	DE LEE	545
Collin-Landau	460	DE Martel-WOLFSON	435
COLLER-Crile	106	De Vilbiss	390
Colley	359-381-382-383-389	Deaver	26-164
Collyer	545	Deaver GRIP-GRIFF	164
Colley (Colley-BABY)	341-342	DEMEL	329
COLIBRI	535	DENIS-Brown	192
CONE	178	Denhart	610
Konus (Adson-BABY)	177	Derf	214-222
Connel	256	Derra	379
CONVERSE	220	DESCHAMPS	229-230-231
COOPER	233	DESCHAMPS STANDARD	229
COTTLE	21-50-586-589-591-592-596-599-600-601-603	DESJARDINS	447-448-449-450
COTTLE-WALSHAM	602	Desmarres	143-513-520-535
COTTLE-NEIVERT	600	Deyen	36
Watteträger	197-198	DE- WECKER	539
CONVERSE	586-599	Dieffenbach (Arterienklemmen)	101
CORYLLOS	163	Dieffenbach (BETRIEBLICHE KNIF)	06-07
Crafoord	47-113-158	DIETHRICH	136-213-355
Crafoord-Sellors	113	Dingmann	170-171-301-614-628
Crile	105-137-143-218-388	Dingmann MODIF	301
Critchett	495	Dingmann-Wilk	628
Crile-WOOD	217-220	Präparieren und neurochirurgischen SCHERE	68
Kronenscheren	77	Präparieren und TONSIL SCHERE	46
CRUTCHFIELD	391	Bestecke	17
CRUNWALD	565	DITTEL	455
CUSCO	459	DIXON-Lovelace	110
CUSCO (Schweizer Bild)	459		

	PAGES #
DIXON-Lovelace	110
Dockhorn	168
DOUBLE MARKER	510
DOUGLAS	96-260
DOYEN	129-161-193-288-423-468-469-480-618
DOYEN-ATRAUMA	424
DOYEN-ROCHARD	193
DOYEN-STILLE	161
Kornzangen	81-83-384
DREW Smythe	457
Bohrerführung und DURA SCHÜTZEN PINZETTE	322
DUVAL	92
DURANTE	92
DUBOIS	35
DUNHILL	108
Duplay	131-475
DUPLEX	241
Dupuy-WEISS	232
DURA Dissektoren	394-395
DURANTE	92
DURHAM	232
DUVAL	422



EASTMAN	464
EAR SPRITZEN	575
Echlin	315
Eiselsberg	71
AUFZÜGE	291
ELCKEN-Killian	605
Elschnig	527
EMMETT	482
Endarteriektomie	200
ENGEL	261
ENGL. MODELL	81-128
Enukleation	538
EPSTEIN	280
Epker	640-641
Epker BAUER	640
ERHARDT	535
ERMOLD	217
ERNEST	534
Esmarch	73-261
EWALD	82
EWALD	88
VERLÄNGERUNG BÖGEN	328
Extraoralen RETRAKTOREN	620
AUGE UND feinen Schere	65-66-67
EYE Kornzange	525
Augenschere	66-67-68-537



	PAGES #
FAULKNER	531
Farabeuf	147-267-283-305
Farabeuf-Collin	283
Farabeuf-Lambotte	306
Farrell (Farrell-Lathbury)	197
Farris-SMITH	92-411
Farris-Smith-KERRISON	408-409-587
Farrior	560
FAURE	125-126-484
Favaloro	41
Fehland	427
Feilchenfeld	94
FEIN	196
FERGUSSON	27-122-251-302-451
Feaster	531
Fiach	558
FINE	501-533
FINE THORNTON	506
FEIN UND Splitterpinzette	91
Leichtbetriebsmodus SCHERE	37
Feinen Schere	39-40
Finochietto	47-119-216-224-339-343
Finochietto BABY	339
Finochietto-BABY-Haight	341
Finochietto-BURFORD	340-344
FINSEN	174
Finsterer	253
FLAP Repositeurs	496
FLACH	558
FLEXIBLE WELLE	488
FISCHER	334
FISH	195
FISTEL MESSER	08
FOERSTER	135
FOMON	21-50-586-594-597-598-599-600
FOX	419
FRANZ	194
FRANKFELDT	198
FRAZIER	137-186-251-252
FREER	520-588-589-591
FRANZÖSISCHE	561
FRIEDMANN	302
Friedmann-DELICATE	309
FRITSCH	161
Frykholm	315
Fuchsig	110
Fueller	416
Fukasaku	498-507

INHALTSVERZEICHNIS (DEUTSCH)



G	PAGES #	H	PAGES #
GRAEFE	526	Haberer	166-434
Gallenwegefunktionsstörungen KLEMMEN	123	HAFMANN THORNTON	506
GARLAND	123	HAGENBARTH	240
GASS	521	HAGLUND-STILLE	262
GAUSS	548	HAIGHT	342
GALLAHER	596	HAJEK	413-587
Gellhorn	484	Hajek-Kofler	413-587
Gelpi	184	Håkansson	310
GERALD	84-90	HALFRICH-BIER	319
Gerbode	389	HALLE	50-279-399
GERZOG	333	HALSEY	214-220
Giertz-STILLE	338	HALSTEAD-MOSQUITO	103-104
GIGLI	390-518	HAMILTON BABY	257
GILLIES	89-137-172-218-228-419-628	HANK	473
GILLIES SLIM	218-228	Hargis	627-633-636
GIL-VERNET	140	HARKEN	350-368
Kiemen VANNAS	539	HARMS	499-517-528
Kiemen WALISER VANNAS	539	Harms-Jafe	499-530
Gimini	117	Harrington-BABY	164
GIRARD	528	HARTMANN	103-309-524
Glick	337	HARTMANN	559-561-562-563-564-566-567-571-580-581-617
GLOBE FIXIERUNG	506	HARTMANN HOFFMANN	567
GLOVER	351-353-378	Hartmann-Halle	576
GLUCK	75	HARTMANN NOYES	567
Goelet	146	HARTMANN-Wullstein	567
GOLDSTEIN	493	HARTMANN WEINGATNER	567
Goldman-Fox	51-78	HARVEY	72
Goldsmith (Thudichum)	576	HASTED	524
Gut	47	HAUTANT	264-266
GOSSET	185-186	HAYES	426
Gradle	95	HAYES PROVIS	457
GRAEFE	68-91-138-494-520	HEAD LAMPS	243
Graether	514	HEANEY	121-165-215
GRAHAM	399	HEANEY-Ballentine	122
Grandon	511	HEANEY-SLIM	121
GRAVE	461	HEATH (ligiert Schere)	71-332
GRAVE (STANDARD)	461	HEATH	535
GRAY	447	HEBRA	418-515
Grazil	26	HEES	525
GRÜN	158-527	Hegar	215-472
GREEN- ARMYTAGE	547	Hegar-Baumgartner	214-221
GREGOIRE	422	Hegar-vaskuläre	223
GREGORY	352-358	Hegemann (DIETHRICH)	44
GREGORY-SOFT	352	HEISTER	610
GRONINGEN	398	HEISS	116
GROSS-MAIER	131	Arterienklemmen	102-104
GRUNWALD	85	HENLEY	177-406
GRUNWALD (Janson)	580	Henner (Lempert)	176
GUILEN	605	HENNING	262
GUM-und Nagelscheren	80	HENRY	95
GUM SCHERE	78	HEOSEL	156
Guthrie (WOUND und Nerv Haken)	138	HEPP-SCHIEDEL	212
GUTTMANN	458	HERRICK	445
GUYON	444-456	Hertzler	186
		HEY	404
		HEY GROVES	303
		HEYMANN	21-50-581
		HEYWOOD-SMITH	441

Hibbs	
HIRSCHMANN	
Hocky MESSER	
HOFFMANN	
HOFFER	
HOHMANN	
Hohmann-ALDINGER	
Hohmann-Williger	
HOIZHEIMER	
HOKE	
HOLSHER	
HOLTH	
HOPKINS	
HORSLEY	
HÖSEL	
HAUS	
HOUSE-DIETER	
HUDSON	
Humby	
HUNT	
HOZLBACH	
HHUNTER	
HYESTERECOTOMY PINZETTE	
HYLIN	

PAGES :-

165-272
437
507
130
509
294-295
296
292
175
269
396
523
261
396
227
558
553
321
15-139
534
123
94
122
286

J

JACKSON	
JACOBSON	
JACOBSON-ADSON	
JACOBSON-HALSTEAD	
JABOMA	
JANSEN	
JANSEN-DEEP	
JANSEN (GRUENWALD)	
JAMESON	
Javid	
JAWS Tiefe	
Jeffe	
Jees	
JENNINGE	
JETER-VAN Sickels	
JHONES	
JOBOMA	
JOBSON-Horne	
Johns-Hopkins	
JOSEPH	
JOSEPH-MASING	
Judd-ALLIS	
Judd-MASSON	
Judet	
JEWELERS	

PAGES :-

139-142-463
58-202-213-281-477
82-109
103
643
97-175-281-284-310-312
175
97
20-38-38-216-565-570
358
179
513-540
526
614-615
632
128-524
98
197
101-114
40-520-586-589-591-595-596-599-600
591
421
453-454
266
529-535

I

IMPECTOR	
INGE	
Darmgewebe UND ORGEL GRASING PINZETTE	
INTIMA Spachtel, VASKULÄREN Dissektoren	
IOWA	
IOL INSERTIN PINZETTE	
Iridektomie SCHERE	
Irispinzetten	
IRIS SCHERE	
Intra Oral RETRAKTOREN	
ISRAEL	
Iterson	
Ives-Fansler	

264
403
422
387
477
501
52-53-54
525
537
621-622-623
152
142
438

K

KADER	
KALMORGEN	
KALT	
KALT-ARRUGA	
KANSAS	
KANTRIWITZ	
Katzin	
Katzin-BARRAQUER	
Kazanjian	
Kelsey-BRJ	
KEEN	
KELMAN-Mc Pherson	
KELLY (Schere)	
KELLY (Zange)	
KELLY (Wundhaken)	
KELLEY	
KERN	
KERRISON	
Kevorkian	
KEY	
KEYES	
Kielland	
KILLIAN	

166
467
210-212-542
210
516
113
55-541
55
317-585
173
632
500-530
36
104-112
159-160-163
521
303
523-568
486
292
419
546
577-581-590-593

INHALTSVERZEICHNIS (DEUTSCH)



	PAGES :-		PAGES :-
KILLIAN	577-581-590-593	LANE	92-129-297-306-431
KILLIAN CLAUS	593	LANE Trethowan	297
KILNER	137-220-419-599	LANGE-Hohmann	294
KILNER-DOUGHTY	611	LANGE-Hohmann MODIF	296
KILNER (Ragnell)	41	LANGE	74
KIRSCH	168	Langenbeck (AMPUTATION MESSER)	09
KIRSCHNER	191-238-328	LANGENBECK	154-225-283-291-302-319-569-609
KLAPP	145	Langenbeck-GRÜN	144-145
KLEINERT-Kutz	139-313-336	Langenbeck-RYDER	225
KLEINSCHMIDT	430	Laryngoskope	245-246-247-248
Klingenberg-Loth	43	LATTICE SCHIENEN	630
KNAPP	65-141-513-537	LASIK	507-508
KNAPP CLARK	494	LAWRENCE	120
KNIGHT	50-581	Lebsche	338
KNOWLES	74	LEES	370
Koberg, MOD	626	LEGUEU	453-454
KOCH	498-502-533	Leksell	315
KOCHER	107-149-150-155-156-161-232-417-428-454	Lempert	310-574
Kocher-ATRAUMA	429	Lerche (TISSUE & Arterienklemmen)	87-106
Kocher-Langenbeck	155	LERICHE	166
Kocher-WAGNER	156	Lesten	497
Körte	152-153-165	LESTER	527
Körte-WAGNER	153	LETTAUER	566
KONIG	143-239-285-292-563	LEWIN	302
CRAFF	532	LEWICKY	497
KRAUSE	260-564-579	LEWIS	597
KRAUSE-VOSS	564-579	LEXER	19-25-268-270-273
CRESSNER	602	LEXER-FINE	25
KREMER	511	LICHTENBERG	218-225
Kristeller	464-465	Lichtwitz	259
Kristeller (STANDARD)	464-465	LIEBERMAN	498
KRONECKER	232	BLATTSCHRAUBE FÄNGER	388
Krönlein	108	BLATTSCHRAUBE LEITER, knoten und Ligatur TIERS	239
KÜHNE	96	BLATTSCHRAUBE NADELN	233
Kümmel	165	BLATTSCHRAUBE SCHERE	71
KUGLEN	497	LIMS	530
KUHNT	527	LISTER	21-73-132
		LISTER BURCH	494
		Lister-exzentrische	73
		LISTON (Amputation MESSER)	09
		LISTON-KEY (Horsley)	317
		Littauer	70
		Littauer-LISTON	316
		LITTLE	140
		Littler	70
		LITTLEWOOD	421
		Livernois	501-533
		Lockhart-MUMMARY	196
		Locklin	79
		LOCKWOOD	421
		Lockwood-ALLIS	420
		LONG	123
		LORENZ	73
		Lorden	535
		LORNA	129
		LOUTE	329
		LOVELACE	110-349
		LOVE (MORSE)	140
			
LABORDE	415		
LA GRANGE	68-79		
Lahey	154-417		
Lahey (SWEET)	120		
LANCASTER	494		
LANGE	519-599		
LAMBERT	534		
Lambotte	270-284-305-306		
LAMINA BODENSPINNEN	405		
Laminektomiestanzen	412		
LANDAU	259-470		
LANDOLT	38		

	PAGES #		PAGES #
UNTERE	117	Mayo-Hegar	215-220-221-223-227
Lowman	307	Mayo-Robson, Mayo-Robson ATRAUMA	425
Lowman-Höglund	307	Mayo-RYDER	223
LUBET-Barbon	580	Mayo-STTILE	19-28
LUC	582	MAYO-Noble	29
Lucae	97-333-562-563-572-573	McDONALD	292
LUER	143-312-416	Mc CULLAUGH	526
LUER-Körte	450	McGivney	443
Lukens	139	McGEE	553-556
Luntz-DODICK	521	Mc Guire	539
LUNG SCHAUFEL	348	Mc Pherson	500-530-535-543
		Mc Pherson WESTCOTT	500-530-535-540
		Mellinger	494
		Mellinger AXENFELD	493-494
		Mellinger BEARD	494
		MCKENZIE	321-392
		MCKENTY	589-590
		MCLVOR	613
		MC. QUIGG-MIXTER	119
		MCLNDOE	43-82-316
		MEAD	310-333
		MESSGERÄTE	244
		Meeker	117
		MENISUCS RETRAKTOR	299
		MENDEZ	508
		MERCEDES-Retraktor	346
		Mershon	173-631
		METZ	625
		METAL KATHETER und Tubuswechsler	456
		METZENBAUM	19-30-31-32-33-227
		METZENBAUM-FINE	19-29-30-31-32-33-227
		Metzenbaum-FINO	33-34
		Meyerding	142-165-184
		MG H	216
		Meyhoefer	515
		MICHEL	240
		MICHEL	240
		MICHEL MODIF	240
		MICRO-ADSON	82-88
		MICRO Dissektionszangen	100
		MICRO Kornzange	99
		Mikropinzette	84
		MICRO Ohrzängchen	550-551
		MICRO-Hoe und EPI-SCHÄLER	496
		MICRO-MOSQUITO	103
		MICRO Nadelhalter	203-204-205-206-207-208-209-504
		Mikro Scheren	57-58-59-60-61-62-63-64
		MICRO RYDER	223
		Middeldorpf	158-159
		MIDDLETON-Janson	585
		MIGIVNEY	442
		Mikulicz	126-127-162
		MILLER	137
		MILLIGAN	177-393
		Millin	255-452-453
		MILLS	69
		MINI-FRIEDMANN	308
		MINI-GEMINI	118
		MINI-Hohmann	293

M

MACEVEN	267
MAGILL	255-256-257
MAGAHARA	498
Magill (nasal)	257
Maltz	596
MALLETS	331-332-333
MALEABLE SCHWARZ	252
MALONEY	503
Mangiagalli	469
Markham-Meyerding	185
Markwalder	316
MARQUARDT	314
MARTEL	124-390
MARTIN	162-302-545
MARTIN-Knorpel	43
MARTINI	281
MARTEL	124
MASING	591
Casanovas	503-532
MASSON	216-224
Mastin	417
MATHIEU	147-219-225-227-436-458-468
Mathieu-KOCHER	226
Mathieu-RYDER	225
Matson	286
Matzenauer	466
MAURER COLLIN	76
Maunder	609
MAYFIELD	313
MAYO	19-33-92
MAYO (Bedienen & Präparierschere)	28-451
Mayo-ADAMS	183
Mayo-BLAKE	448
MAYO-Collin	147
MAYO-Guyon	445

	PAGES #
PATTIGROVE	507
PAYR	236
PAYR (PAYR-BABY)	432
SCHEN	102-107-259
PEDERSON	462
PEERS-Bertram	128
PEET	94
Pelkmann	131
PELTSON	196
PENFIELD	394
PENNINGTON	102-590
Perkussionshämmer	242
PERCY	305
PERTHES	322
Perineum Dammscheren	49
Periostale Raspatories	285-288-289-290
Peripheral Vascular KLEMMEN	361
Peritoneale CLAMP und Hysterektomie PINZETTE	126
Phaneuf	122
PHACO Zubehör	512
PIERCE	260-590
Pieres	528
Pierres-Hoskin	536
Piffard	418
PIGTAIL	517
PINARD	241
PITHA	609
PLASTISCHE	20
Plester	175-252-554
Plester-Spatel	196
POTTS-DE MARTEL	69
POIRIOER	265
POIRIOER TRIUAT	265
POLLOSON	163
POOLE	253
POLACK	528
FLEISCHUNTERSUCHUNG SET	14-18
POTTS	375
POTTS-SMITH (Vascular Schere)	22-41-42-43
POSTTS-SMITH (Dressing & chirurgische Pinzette)	85-90
Politzer	573
PRATT	101-196-436-473
PRE CHOPPER	502-534
PRE-Chopper für weichen Star	502-534
PREIS-THOMAS	349
PRINCE	46
SONDEN	195-196
PROVIDENCE	106
PROVIS INTRA	457
PUTTI	282
	
QUEEN square	243
Quervain	291
Quinby	78
ETWAIGE	566

R

	PAGES #
Rabiner	243
RALK	94-320
RAMSAY	92
RAMUS	169
RANDALL	446
RANEY	392
RANPLEY	135
Rangell DAVIS	144
RASIERKLINGENSTÄRKE gepreist	16
REKTALE SPECULAS	436
Recamier	490
REINER	261
Resano	426
RETINAL SPATULA	505
RETRAKTOREN	140-153-174
Retraktoren und BONE RETRAKTOREN	148-149-150
RETRAKTOREN Kiefer-und Gesichtschirurgie	168-170-172
RETRAKTOREN und Meniskus RETRAKTOREN	158
Reverdin	166-234-235
REYNOLDS	20-22-38
RIB SCHEREN	337
RICARD	184
RICHARDSON	159-160
RICHARDSON-Eastman	159
RICHTER	27-184
RICHTER-HEATH	240
RIGBY	185
RITTER-HALLE	605
Rizzuti	514
ROBB	387
ROBERTS	112
ROCHARD	193
Rochester-Carmalt	108
ROCHERTER-SCHEN	107
ROEDER	129
ROGER	121-514-591
ROLLET	513
ROLLE	517
ROSE	143
ROSER-König	610
ROSEN	498-554-555-558
Rosenbaum-DREWS	514
ROSS	167
Röttgen-RUSKIN	314
Rotunda Hospital	457
ROWE	631-634
ROUX	146
FUBIN	592-602
RUDD	442
Rumel	114
Rumel-Belmont	388
RUSKIN	313
RUSKIN-LISTON	317
RUSS. MODELL	92
RYDER	223
Rydel-Seiffert	563

INHALTSVERZEICHNIS (DEUTSCH)



S

	PAGES #		PAGES #
SAALFELD	418	SEUTIN	75
SACHS	393-397-399	SEXTON	573
SAKAMOTO	633	SHAMBAUCH	557
Salyer	633	Shapleigh	569
Salyer (CLAFT GAUMEN INSTRUMENTS)	643	SHEA	557-623
SALENIUS	300	SHORTBENT	70
SANDERS-BROWN	173	SIEBOLD	20-34-36
Santulli	352	Silia UND Deckglaspinzetten	96
SANVENERO	40	SILBER	595
Saenger	547	SIMS	20-34-35-436-463-474-489
Sarot	113-216-223	SIMS-Maier	131
Satinsky	43-350-369	SIMON (PISTULA MESSER)	08
SATTEERLEE	319	SIMON	161-278-482-489
SAUER	493	SIMPSON	546
SAUERBRUCH	154-163-315-338	SIMPSON BRAUN	546
Sauerbruch-FREY	338	SIMPSON LUIKERT	546
SAYFFERT	462	SIMPSON-SMITH	255
Skalpellgriffe	01-02-03	Smellie	548
Schadel	128	Snellen	534
Schede	277	Singley-Tuttle	93
SCHANZ	330	Sinskey	497-530
Schamberg	418	Sinus Lift Küretten	607-608
SCHINDLER	126	Skene	476
Schink (Hauttransplantation MESSER)	15	Smillie	299-300
SCHMID	200	SMITH	72
Schmidt-Rimpler	526	SMITH (sagittale Spaltung Separatoren, RAMUS)	637
Schmieden	233-238	SMITH-BULE	437
Schmieden-DICK	233	SMITH (MOD. USA)	74
Schmieden-PAYR	238	Smith-Peterson	269-314
SCHNEIDER	284	Smithwick	398
SCHNEIDER-Sauerbruch	284	SOERESEN-Hein	170
SCHNIDT	111	SOMER	481
SCHOEMAKER-Loth	71	Spackmann	457
Schönborn	415	Ersatzklingen	15
SCHRODER	475-476	SPENCER	70-538
SCHUBERT	484-485	Spencer-FINE	70
SCHUCHARDT	625	SPENCER WELLS	120
Schuknecht	72-554	SPINAL	280
SCHUMACHER	48-296-486-488	SPINA-nasalis	169
SCHWARTZ	136	Spivey	514
Scoville	187-396	Splitterpinzette	94
Scoville-Haverfield	187	SPRATT	276
Scoville-Richter	187	STANDARD-ADSON	88
Scudder	423	STANDARD (Dressing & chirurgische Pinzette)	81-86-87
Scudder / Sudder-ATRAUME	433	STANDARD (GUM-und Nagelscheren)	80
SEBILEAU	292	STANDARD (Betriebs-und einer feinen Schere)	23-24-39
Sedillot	283	STANDARD (NELSON)	258
SEGAND	480	STACKE	195
Segond	126	STEINHAUSER	628-629-632-635
Segond-Landau	126	Steinhauser (MYLOHYOLD MUSCLE und Ramus KLAMMERN)	639
Sellheim	548	Steinhauser (OSTEOTOME)	641-642
Seldin	284	STEINMANN	334-335
Sellors	347	STEINERT	501-533
Semb	288-304-311-317-349	STERN-Kiemen	539
Semken (Dressing & chirurgische Pinzette)	82-89	STERNBERG	256-615
SEMM	191	STEVENS	21-67-210-538-543
Senn-GRÜN	144	STEVENSON	495
Senn-MILLER	144	STILLE	75-76-81-263-272-315-321-445
SERREFINE	524	Stille-BARRAYA	93

	PAGES #		PAGES #
Stille-LISTON	317	Trephine ALKOHOL WEL	496
Stille-LUER	311	TREPLE MARKER	510
Stille-RUSKIN	315	TROKARE	258
ST. MARKS	157	TROELTSCH	97-580
STOCKMANN	458	Troeltsch (Wilde)	97-565
STONE	87	Trousseau	415
Strandell-STILLE	145	Aussteuer-BABY	415
STRATTE	224	TROUTMAN-BARRAQUER	54
STRAUSS	458	TROUTMAN	55
STRULLY	69	TROUTMAN CASTROVIEJO	541
STRUEMPEL	567	TROUTHMAN-LLOBERA	526
Struykken	584	TROUTMAN-CASTROVIEJO	56
Saugrohre	251	Tubba	389
SULLIVAN	79	TUBING Pinzette	130
Supercut Scheren	19-20-22	TÜBINGEN	162
SCHWEDISCH PAERN	223	Tuebinger-MODELL	176
		Tuffier	101-161-166-340-344
		TUNNELING PINZETTE	133
		TURNER WARWICK	194
		Turvey	644
		BINDEN	530
T		U	
TABB	554	UBIRE-STERM	539
TAKAHSHI	583	Uckermann	197-415
TAYLOR	83-89-187-242-299	ULRICH (PISTULA MESSER)	08
TARNIER	548-549	ULRICH	132-303-467
Teale	476	Universalschere	51-71-72
TENDON EINSTAPELUNG INSTRUMENTS	334-335	UNIVERSAL	197-258
TENNANT	513-530	UNNA	418
TERRY	606-638-639	UROLOGIE Tubuswechsler	458
TESSIER	170-172	URERINE PULYPUS PINZETTE	479
THIERSCH	15	UTERINE Küretten	491
THOMAS-ALLIS	420	UTERINE DILATATOREN	473
THOMAS GAYLOR	485	UTERINE Tenakulum PINZETTE	478
THOMSON-WALKER	454	UTILITY	525
THORNTON	506-509	Utrata	503-532-533
Tieck-HALLE	577		
Chirurgische Pinzette	86-87-88	V	
Gewebe-Greifeinrichtung und Uhrmacher PINZETTE	93	VAGINAL SPECULAS	462-466-467
Tobold	256-617	VAN BUREN	301-455
Toennis	46-117-219-226-393-399	VANNAS	53-539
TOHOKU	128	Van Doren	485-486
Tönnis	46	VANNAS MOD, tübingen	53
Mandeln und Enterotomie SCHERE	47	Krampfadem PROBE SET	199
Tuchklemmen	128	VASKULÄREN SCHERE	45
Townley	244	Verbrugge	304
Toynbee	559	Verbrugge MULLER	294
TRACHEA RETRAKTOREN	142	VIDAL	419
TRAUBE	242	Virchow (post mortem)	10
TRAVERS	179	VIRCHOW (Knorpel MESSER)	11
Trélat	460	Virchow (Autopsieskalpelle)	12
TREUBNAN-CHRIS (Rasierklinge gepreist)	16	VOLKMANN	142-148-149-275-278
TREVES	87	Voltoini	576
Trephine ALKOHOL WEL	496		

INHALTSVERZEICHNIS (DEUTSCH)



W	PAGES #
Wachenfeldt	240
WAGENER	572
WAGNER (Leichtbetriebsmodus Schere)	20-37-290
Walb	10
WALDMANN	48
WALDAU	526
WALLEIX	474
WALTER	592-594
WALTER-Carmalt	94
WALTON	39
Wangensteen	85-216-224
WARTENBERG	241
Wassmund	152
WATSON-CHEYNE	195-292
Watson-Williams	583
Waugh (Dressing & chirurgische Pinzette)	83-90
WEBER	241-367
WEBER-LOCK	571
WEBSTER	214-222
WECKER	52
WEISS	492-495
Weitlaner	176-178
Weitlaner-BABY	177
Weitlaner-Wullstein	176
WELLER	34
WEIL	583
Weil-BLACKESLEY	584
WELLET-Martel	548
WERTHEIM	35-124-125-127
Wertheim-CULLEN	124
WESTCOTT	540
WEST	520
WELLS	516
WICKSTROEM	119
WILDER	518
WIEN	239
WIENER	597
WIEDER	617
WILLS KRANKENHAUS	518-526
WILLIAMS	421-494
Williger	277-281-284-285-291-332
WILMER	68
WINTER	547
Drahtschneidezangen	325-326-327
WIRE EINSTAPELUNG FORCPS	323-324
WRIGLEY	546
WOLF	263-419
WOLFORD	633
Wolford (OSTEOTOME)	642
WOUND und Nerven HAKEN	138
WOUND und Luftröhre RETRAKTOREN	141
Wullstein	552-554

Y	PAGES #
Yankauer	254-255-291
Yankauer UNIVERSAL	255
YASARGIL	203-205-251-407-414
YEOMAN	440
Yeoman (TURRELL)	440
YOUNG	234-256-452-619

Z	PAGES #
Zaufal	571
ZENKER	114-165
ZIEGLER	96-517-532
ZWEIFEL	123-226
ZOLLNER	560
ZIELKE	272

A	PAGES #		PAGES #
Bauchdeckenhalter	181-190-193-194	Axenfeld	513-518
Bauch-und darm Schaufel	166	Axenfeld CURRETTES	517
ADLERKREUTZ	89	Ayre - Wangenhalter	257
Adson Brown	88	AYRE - FISTEL HAKEN	482
Adson HUESO Hohlmeißelzange	312	Ayer - PINZETTE	534
Adson Dissektionszangen	46		
Adson Kornzange	82		
Adson NORMA PINZETTE	82		
Adson Guía de broca	322		
Adson DURA HAKEN	399		
Adson (Schere)	46		
Adson-MULTA	46		
Adson hämostatischen Dissektionszangen	109		
Adson BLATTSCHRAUBE	95		
Adson Tupferzange	97		
Adson NADELHALTER	217		
Adson periostale Raspatories	285		
Adson RETRAKTOREN	178-179-180		
Adson-STANDARD	82		
Adson Saugrohre	252		
Adson chirurgische Pinzette	88		
ADLER	523		
AEBIL	54		
AFRICH	599		
ADAMS	609		
ASCH	603		
Aufricht	596-601		
AGRICOLA	475-495		
ALDERDYCE	292		
ALEXANDER- Knochenmeißeln	268		
ALEXANDER - periostalen Raspatories	284		
ALEXANDER - uterina BIOPSIEZANGEN	487		
ALLEN	430		
ALLIS	420		
ALLIS-ADAIR	420		
ALLIS-ATRAUMA	420		
ALLISON	348		
ALLPORT	174		
ALM	174		
ALEXANDER	487		
ALY	241		
AMPUTACIÓN MESSER	09		
Anastomosis Klammern UND PEDICTRIC GEFÄSSKLEMMEN	379		
Anderson-Adson	178		
Andrew-PYNCHONE	254		
ANIS	518		
Arnest	502		
ARRUGA	210-211-213-227-493-542		
ARRUGA - EYE espécules	493		
ARRUGA - Nadelhalter	542		
ATRAUMA	136		
Atraumatische FACO	506		
FLECHA SMITH	511		
ARNHEIM	635		
Aufricht	596-601		
ASCH	602		
AUSTIN	84-557		
AUVARD	470		
Axhausen	218-226		
		B	
		BABCOCK	200-421
		BABCOCK atraumatique	421
		BABCOCK (STANDARD)	421
		Babinsky	243
		Adson BÉBÉ	109
		BÉBÉ ALLIS	420
		BABCOCK POUR BEBE	421
		BALFOUR BÉBÉ	188
		BABY-BARRAQUER	493
		BÉBÉ COLLIN	182
		BÉBÉ Crile	105
		BABY-BOIS Crile	220
		DOYEN DE BEBE	423
		Hegemann BEBE	44
		BABY-KOCHER	428
		BÉBÉ Lexer (KNAPP)	40
		Metzenbaum BÉBÉ	19-29
		Mikulicz BÉBÉ	127
		MIXTER BÉBÉ	118
		BABY-HEGAR OLSEN	217-228
		Overholt BÉBÉ	114
		BÉBÉ POOLE	253
		BABY-ROUX	146
		Satinsky BÉBÉ	350
		SENN-MILLER BÉBÉ	144
		Backhaus	128-524
		BACON	309
		BAILEY	347
		BÉBÉ BAILEY	347
		BAILEY-GIBBON	347
		BAINBRIDGE	110-362
		Bakes	44
		Ballenger - HAJEK	590
		BALLENER	588-593
		BALFOUR	188-189-190
		BALFOUR nous-Type	190
		BOULE ET PRISE	129
		Ballentine	122
		CISEAUX BANDAGE	74
		ET FIL DE COUPE CISEAUX BANDAGE	72
		BANE-HARTMANN	308
		BARBARA	555-556
		Bard-Parker	544
		BARD-PARIIZER	544
		BARR	437
		BARRAQUER	52-95-212-499-504-526-532-539-542
		BARRAQUER COLIBRI	493
		Barsky	139

INDEX (français)



B

BARTH	281
BAUER	640
Belucci	175
Bengolea	111
BENNETT	95-298
Bensaude	437
BENSON	430
BERGMANN	07-73-142-151-331-332
BERKE	534
BERLINER	242
BERNHARD	129
Bertillon	244
BEAUPRE	95
Beacham	475
Bechert	496
Bechert-Mc PHERSON	500-529
BECKMANN	180-604
Beckmann-Adson	179
Beckmann-EATON	181
BeeBee	77
BIÈRE	96-532
Beeson	262
BESNIER	419
BEYER	310
BEYER Zaufal JANSEN	313
BIRCHER	300
Billeau	571
Bircher-Ganske	302
BIRKETT	111
ÉVÊQUE	616
BISHOP-HARMON	499-525
SPREADORS Messer LAMINA FÜR	400
BLAKE	448
Blaydes	501-531
Blasrohre & FLEISCHUNTERSUCHUNG SET	14-18
BLOUNT	153-158-298-299
BLUMENTHAL	310
BOHLER	313-316
BONACCOLTO	526-531
Knochenmeißeln	264-265-271
Resektionslöffel	276-277-279-280-281
Knochenbohrer	320
OS Feilen und Raspeln	282
OS Augenschere	67
OS Böhrt	273
OS Halteklammern	307
Knochenhaltezange	301-306-307
Knochenhaltezange AUTO ZENTRIEREN	305
OS HEBEL	293-294
Knochnagel	330
CISAILLEMENT OS	75
BONN MODELL	538
BONNEY	83-93
BOHRUNGEN	508-510-511
BOSE	174-415
BÖTTCHER	46
Bowdler-Harry'S	172
BOWLES	493-517
BOWLES	241

BOYNTON	211-227
BOZEMANN	134-222-239-471
BOZEMANN DOUGLAS	135
BOZEMANN FRITSCH	457
CERVEAU RETRAKTOR	407
MARQUE	108-334-336
BRAUN	48-466-467-474-475-478-549
BRAUN-Stadler	21-48
Breisky	470-545
BRIAN und Aufzüge	397
Brücke	112
BRISTOW	297
BROCK	419
Brodie	195
BROPHY	83-90
Brophy (Sullivan)	38
BROWN	89-214
Brunetti (Autopsieskarpelle & Meissel)	13
BRUNNER	162-236-237-238-338-427
BRUNNER-FERROZALL	238
BRUNS	74-274-276
Brunings	568-582-588-618
BRYANT	132
BUCCI	552
BUCK	242-566-569-570-573
Buck-Gramcko	293
BUELAU	259
Buie	123-196-441
Bulldogklemmen	354
BULLDOS PINZETTE	136
BULLDOG Arterienklemmen	101
BUNGE	515
BURFORD	343
BUSCH	48
Bushe	279
BEYER	522

C

CANAD-MODELL	300
C-STAHL	543
Caroll	244-335
CARREL	101
CARTLIAGE Messer	11
KARTON	457
CASPER	155-401
CASTANEDA	341-386
CASTROVIEJO	16-54-56-201-202-211-212-528
CASTROVIEJO (Tränendrüse INSTRUMENTS)	495-499-504-517-519
CASTROVIEJO (Schere)	540-541
CASTROVIEJO (Nadelhalter)	542
CASTROVIEJO (AUFBRUCH)	543
CASTROVIEJO-KALT	210-542
Catlin (amputation MESSER)	09
Cauchoix	266
Cawood-Minnesota	616
Halswirbeltraktionsgerät PINCES	391
CHADWICK	68-80
CHANDLER	298

	PAGES #		PAGES #
CHAPUT	101	Cushing (Kornzangen)	85-90
CHARRIERE	319	CUSHING	137-143-145-321-398
Chavalier JACKSON	416	CUSHING-Kocher	145
CHERON	134	CUSHING-TAYLOR	85
NATURE	240	CZERNY	155-436-448-478
CHISEL	271		
Meissel-COURBE	271		
MANDRIN POIGNÉE	544		
CINELLI	594		
Citelli	522-568	D	
Citelli BEYER	568	DAHIGREN	390
Clayman	531	DALE	357
CLTTLE	578	DANDY	51-69-108-398
CLEVELAND	309-316	DARDIK	356
Kleidung Schere	75	Dartigues	481
Gips RIB und Scheren	75	SASTOOR	519
Clovis Vincent	308	Daubenspeck	278
Cloward	402-403	DAVIDSON	167
COAKLY	260-604	DAVIDSON-ALEXANDER	284
Koaptation	535	DAVIS	394
COBB	257-273-287-290	DAVIS BOYLE	612
Cohan	528	Dean	79
COOK	494	Deaver	26-164
Colclough	410	Deaver GRIP-GRIFF	164
COLLER-Crile	106	De Bakey	41-44-97-185-221-345-354-360-361
COOLEY	167	De Bakey	362-363-364-365-366-367-372-374-377-378-379-380
Collier (Nadelhalter)	214	De Bakey-Bahnsen	373
Collin (Skalpellgriff)	01	De Bakey BECK	379
COLLIN	102-134-147-181-182-183-240-244-256	De Bakey-FINE	221
COLLIN	460-481-545-549-619	De Bakey-MOSQUITO	355
Collin-Duval	92	De Bakey-schen	376
Collin-Hartmann	146	De Bakey-Rankin	355
Collin-Landau	460	De Bakey-Satinský	351
COLLER-Crile	106	Deitz	508
Colley	359-381-382-383-389	DE LEE	545
Collyer	545	DE Martel-WOLFSON	435
Colley (Colley-BABY)	341-342	De Vilbiss	390
COLIBRI	535	Deaver	26-164
CONE	178	Deaver GRIP-GRIFF	164
Konus (Adson-BABY)	177	DEMEL	329
Connel	256	DENIS-Brown	192
CONVERSE	220	Denhart	610
COOPER	233	Derf	214-222
Cottle	21-50-586-589-591-592-596-599-600-601-603	Derra	379
Cottle-Walsham	602	DESCHAMPS	229-230-231
Cottle-NEIVERT	600	DESCHAMPS STANDARD	229
Watteträger	197-198	DESJARDINS	447-448-449-450
CONVERSE	586-599	Desmarres	143-513-520-535
CORYLLOS	163	Deyen	36
Crafoord	47-113-158	DE- WECKER	539
Crafoord-Sellors	113	Dieffenbach (Arterienklemmen)	101
Crile	105-137-143-218-388	Dieffenbach (BETRIEBLICHE knif)	06-07
Critchett	495	DIETHRICH	136-213-355
Crile-BOIS	217-220	Dingmann	170-171-301-614-628
Kronenscheren	77	Dingmann MODIF	301
CRUTCHFIELD	391	Dingmann-Wilk	628
CRUNWALD	565	Präparieren und neurochirurgischen Schere	68
CUSCO	459	Präparieren TONSIL und Schere	46
CUSCO (Schweizer Bild)	459	Bestecke	17
		DITTEL	455
		DIXON-Lovelace	110

INDEX (français)



	PAGES #
DIXON-Lovelace	110
Dockhorn	168
MARQUEUR DOUBLE	510
DOUGLAS	96-260
DOYEN	129-161-193-288-423-468-469-480-618
DOYEN-atraumatique	424
DOYEN-ROCHARD	193
DOYEN-STILLE	161
Kornzangen	81-83-384
DREW Smythe	457
Bohrerführung und DURA Schützen PINZETTE	322
DUVAL	92
DURANTE	92
DUBOIS	35
DUNHILL	108
Duplay	131-475
DUPLEX	241
Dupuy-WEISS	232
DURA Dissektoren	394-395
DURANTE	92
DURHAM	232
DUVAL	422



EASTMAN	464
EAR SPRITZEN	575
Echlin	315
Eiselsberg	71
Aufzüge	291
ELCKEN-Killian	605
Elschnig	527
EMMETT	482
Enderarteriektomie	200
ENGEL	261
ENGL. MODELL	81-128
Enukleation	538
EPSTEIN	280
Epker	640-641
Epker BAUER	640
ERHARDT	535
Ermold	217
ERNEST	534
Esmarch	73-261
EWALD	82
EWALD	88
Verlängerung BOGEN	328
Extraoralen RETRAKTOREN	620
AUGE UND Feinen Schere	65-66-67
YEUX Kornzange	525
Augenschere	66-67-68-537



	PAGES #
FAULKNER	531
Farabeuf	147-267-283-305
Farabeuf-Collin	283
Farabeuf-Lambotte	306
Farrell (Farrell-Lathbury)	197
Farris-SMITH	92-411
Farris-Smith-Kerrison	408-409-587
Farrior	560
FAURE	125-126-484
Favaloro	41
Fehland	427
Feilchenfeld	94
FEIN	196
FERGUSSON	27-122-251-302-451
Feaster	531
Fiach	558
FINE	501-533
FINE THORNTON	506
FEIN UND Splitterpinzette	91
Leichtbetriebsmodus Schere	37
Feinen Schere	39-40
Finochietto	47-119-216-224-339-343
Finochietto BÉBÉ	339
Finochietto-BABY-Haight	341
Finochietto-BURFORD	340-344
FINSEN	174
Finsterer	253
Repositeurs FLAP	496
FLACH	558
FLEXIBLE WELLE	488
FISCHER	334
POISSON	195
FISTEL MESSER	08
FOERSTER	135
Fomon	21-50-586-594-597-598-599-600
FOX	419
FRANZ	194
FRANKFELDT	198
FRAZIER	137-186-251-252
FREER	520-588-589-591
FRANZÖSISCHE	561
FRIEDMANN	302
Friedmann-DÉLICATS	309
FRITSCH	161
Frykholm	315
Fuchsig	110
Agent d'avitaillement	416
Fukasaku	498-507

G	PAGES #	H	PAGES #
GRAEFE	526	Haberer	166-434
Gallenwegefunktionsstörungen KLEMMEN	123	HAFMANN THORNTON	506
GARLAND	123	HAGENBARTH	240
GASS	521	HAGLUND-STILLE	262
GAUSS	548	HAIGHT	342
GALLAHER	596	HAJEK	413-587
Gellhorn	484	Hajek-Kofler	413-587
Gelpi	184	Håkansson	310
GERALD	84-90	HALFRICH-BIER	319
Gerbode	389	HALLE	50-279-399
GERZOG	333	HALSEY	214-220
Giertz-STILLE	338	HALSTEAD-MOUSTIQUES	103-104
GIGLI	390-518	HAMILTON POUR BEBE	257
GILLIES	89-137-172-218-228-419-628	HANK	473
GILLIES SLIM	218-228	Hargis	627-633-636
GIL-VERNET	140	HARKEN	350-368
Kiemen Vännäs	539	HARMS	499-517-528
Kiemen Waliser Vännäs	539	Harms-JAFE	499-530
Gimini	117	Harrington-BABY	164
GIRARD	528	HARTMANN	103-309-524
Glick	337	HARTMANN	559-561-562-563-564-566-567-571-580-581-617
GLOBE FIXIERUNG	506	HARTMANN HOFFMANN	567
GLOVER	351-353-378	Hartmann-Halle	576
GLUCK	75	HARTMANN NOYES	567
Goelet	146	HARTMANN-Wullstein	567
GOLDSTEIN	493	HARTMANN WEINGATNER	567
Goldman-Fox	51-78	HARVEY	72
Goldsmith (Thudichum)	576	Hasted	524
Gut	47	HAUTANT	264-266
GOSSET	185-186	HAYES	426
Gradle	95	HAYES PROVIS	457
GRAEFE	68-91-138-494-520	Lampes frontales	243
Graether	514	HEANEY	121-165-215
GRAHAM	399	HEANEY-Ballentine	122
Grandon	511	HEANEY-SLIM	121
GRAVE	461	HEATH (ligiert Schere)	71-332
GRAVE (STANDARD)	461	HEATH	535
GRAY	447	Hebra	418-515
Grazil	26	HEES	525
GRÜN	158-527	Hegar	215-472
VERT-Armytage	547	Hegar-Baumgartner	214-221
GREGOIRE	422	Hegar-vasculäre	223
GREGORY	352-358	Hegemann (DIETHRICH)	44
GREGORY-SOFT	352	HEISTER	610
GRONINGEN	398	HEISS	116
GROSS-MAIER	131	Arterienklemmen	102-104
GRUNWALD	85	HENLEY	177-406
GRUNWALD (Janson)	580	Henner (Lempert)	176
Guilen	605	HENNING	262
GUM-und Nagelscheren	80	HENRY	95
GUM Schere	78	HEOSEL	156
Guthrie (PLAIE und Nerv Haken)	138	HEPP-Schiedel	212
GUTTMANN	458	HERRICK	445
GUYON	444-456	Hertzler	186
		HEY	404
		HEY GROVES	303
		HEYMANN	21-50-581
		HEYWOOD-SMITH	441

INDEX (français)



	PAGES :-
Hibbs	165-272
HIRSCHMANN	437
Hocky MESSER	507
HOFFMANN	130
HOFFER	509
HOHMANN	294-295
Hohmann-Aldinger	296
Hohmann-Williger	292
HOIZHEIMER	175
HOKE	269
HOLSHER	396
Holth	523
HOPKINS	261
HORSLEY	396
HOSEL	227
HAUS	558
MAISON-DIETER	553
HUDSON	321
Humby	15-139
HUNT	534
HOZLBACH	123
HHUNTER	94
HYESTERECOTOMY PINZETTE	122
HYLIN	286

	PAGES :-
I	
IMPECTOR	264
INGE	403
Darmgewebe und Orgel Grasing PINZETTE	422
INTIMA Spachtel, VASKULÄREN Dissektoren	387
IOWA	477
LIO INSERTIN PINZETTE	501
Iridektomie Schere	52-53-54
Irispinzetten	525
IRIS Schere	537
Intra Oral RETRAKTOREN	621-622-623
ISRAEL	152
Iterson	142
Ives-Fansler	438

J

	PAGES :-
JACKSON	139-142-463
JACOBSON	58-202-213-281-477
JACOBSON-Adson	82-109
JACOBSON-HALSTEAD	103
JABOMA	643
JANSEN	97-175-281-284-310-312
JANSEN-DEEP	175
JANSEN (Gruenwald)	97
JAMESON	20-38-38-216-565-570
Javid	358
JAWS Tiefe	179
Jeffe	513-540
Jees	526
JENNINGE	614-615
JETER-VAN Sickels	632
JHONES	128-524
JOBOMA	98
JOBSON-Horne	197
Johns-Hopkins	101-114
JOSEPH	40-520-586-589-591-595-596-599-600
JOSEPH-Masing	591
Judd-ALLIS	421
Judd-MASSON	453-454
Judet	266
JEWELERS	529-535

K

KADER	166
KALMORGEN	467
KALT	210-212-542
KALT-ARRUGA	210
KANSAS	516
KANTRIWITZ	113
Katzin	55-541
Katzin-BARRAQUER	55
Kazanjan	317-585
Kelsey-BRJ	173
KEEN	632
KELMAN-Mc Pherson	500-530
KELLY (Schere)	36
KELLY (Zange)	104-112
KELLY (Wundhaken)	159-160-163
KELLEY	521
KERN	303
Kerrison	523-568
Kevorkian	486
KEY	292
KEYES	419
Kielland	546
KILLIAN	577-581-590-593

	PAGES :-		PAGES :-
KILLIAN	577-581-590-593	LANE	92-129-297-306-431
KILLIAN CLAUS	593	LANE Trethowan	297
Kilner	137-220-419-599	LANGE-Hohmann	294
Kilner-DOUGHTY	611	LANGE-Hohmann MODIF	296
Kilner (Ragnell)	41	LANGE	74
KIRSCH	168	Langenbeck (amputation MESSER)	09
KIRSCHNER	191-238-328	LANGENBECK	154-225-283-291-302-319-569-609
KLAPP	145	Langenbeck-GRÜN	144-145
KLEINERT-Kutz	139-313-336	Langenbeck-RYDER	225
Kleinschmidt	430	Laryngoskope	245-246-247-248
Klingenberg-Loth	43	LATTICE Schienen	630
KNAPP	65-141-513-537	LASIK	507-508
KNAPP CLARK	494	LAURENT	120
KNIGHT	50-581	Lebsche	338
KNOWLES	74	LEES	370
Koberg, MOD	626	Legueu	453-454
KOCH	498-502-533	Leksell	315
KOCHER	107-149-150-155-156-161-232-417-428-454	Lempert	310-574
Kocher-atraumatique	429	Lerche (TISSU & Arterienklemmen)	87-106
Kocher-Langenbeck	155	LERICHE	166
Kocher-WAGNER	156	Lester:	497
Korte	152-153-165	LESTER	527
Korte-WAGNER	153	LETTAUER	566
KONIG	143-239-285-292-563	LEWIN	302
CRAFF	532	LEWICKY	497
KRAUSE	260-564-579	LEWIS	597
KRAUSE-VOSS	564-579	LEXER	19-25-268-270-273
CRESSNER	602	LEXER amende de	25
KREMER	511	LICHTENBERG	218-225
Kristeller	464-465	Lichtwitz	259
Kristeller (STANDARD)	464-465	LIEBERMAN	498
Kronecker	232	BLATTSCHRAUBE FANGER	388
Kronlein	108	BLATTSCHRAUBE Leiter, Knoten und TIERS Ligatur	239
KÜHNE	96	BLATTSCHRAUBE Nadeln	233
Kümmel	165	BLATTSCHRAUBE Schere	71
KUGLEN	497	LIMS	530
KUHNT	527	LISTER	21-73-132
		LISTER BURCH	494
		Lister-exzentrische	73
		Liston (amputation MESSER)	09
		LISTON-KEY (Horsley)	317
		Littauer	70
		Littauer-LISTON	316
		PETITE	140
		Little	70
		LITTLEWOOD	421
		Livernois	501-533
		Lockhart-MUMMARY	196
		Locklin	79
		LOCKWOOD	421
		Lockwood-ALLIS	420
		LONG	123
		LORENZ	73
		Lorden	535
		LORNA	129
		Loute	329
		LOVELACE	110-349
		AMOUR (MORSE)	140
			
LABORDE	415		
LA GRANGE	68-79		
Lahey	154-417		
Lahey (SWEET)	120		
LANCASTER	494		
LANGE	519-599		
LAMBERT	534		
Lambotte	270-284-305-306		
LAMINA BODENSPINNEN	405		
Laminektomiestanzen	412		
LANDAU	259-470		
LANDOLT	38		

INDEX (français)



	PAGES #		PAGES #
Untere	117	Mayo-Hegar	215-220-221-223-227
Lowman	307	Mayo-Robson, Mayo-Robson atraumatique	425
Lowman-Höglund	307	Mayo-RYDER	223
Lubet-Barbon	580	Mayo-STTILE	19-28
LUC	582	MAYO-Noble	29
Lucae	97-333-562-563-572-573	McDONALD	292
LUER	143-312-416	Mc CULLAUGH	526
LUER-Korte	450	McGivney	443
Lukens	139	McGEE	553-556
Luntz-DODICK	521	Mc Guire	539
POUMON SCHAUFEL	348	Mc Pherson	500-530-535-543
		Mc Pherson WESTCOTT	500-530-535-540
		Mellinger	494
		Mellinger Axenfeld	493-494
		BARBE Mellinger	494
		MCKENZIE	321-392
		McKenty	589-590
		Mclvor	613
		MC. QUIGG-MIXTER	119
		McIndoe	43-82-316
		MEAD	310-333
		Messgeräte	244
		Meeker	117
		MENISUCS RETRAKTOR	299
		MENDEZ	508
		MERCEDES-Retraktor	346
		Mershon	173-631
		METZ	625
		METAL KATHETER und Tubuswechsler	456
		Metzenbaum	19-30-31-32-33-227
		Metzenbaum-FINE	19-29-30-31-32-33-227
		Metzenbaum-FINO	33-34
		Meyerding	142-165-184
		MG H	216
		Meyhoefer	515
		MICHEL	240
		MICHEL	240
		MICHEL MODIF	240
		MICRO-Adson	82-88
		MICRO Dissektionszangen	100
		MICRO Kornzange	99
		Mikropinzette	84
		MICRO Ohrzängchen	550-551
		MICRO-Hoe und EPI-Schaler	496
		MICRO-MOSQUITO	103
		MICRO Nadelhalter	203-204-205-206-207-208-209-504
		Mikro Scheren	57-58-59-60-61-62-63-64
		MICRO RYDER	223
		Middeldorpf	158-159
		MIDDLETON-Janson	585
		MIGIVNEY	442
		Mikulicz	126-127-162
		MILLER	137
		MILLIGAN	177-393
		Millin	255-452-453
		MOULINS	69
		MINI-FRIEDMANN	308
		MINI-GEMINI	118
		MINI-Hohmann	293

M

MACEVEN	267
MAGILL	255-256-257
MAGAHARA	498
Magill (nasale)	257
Maltz	596
BAGUETTES	331-332-333
Malléable SCHWARZ	252
MALONEY	503
Mangiagalli	469
Markham-Meyerding	185
Markwalder	316
MARQUARDT	314
MARTEL	124-390
MARTIN	162-302-545
MARTIN-Knorpel	43
MARTINI	281
MARTEL	124
Masing	591
Casanovas	503-532
MASSON	216-224
Mastin	417
MATHIEU	147-219-225-227-436-458-468
Mathieu-KOCHER	226
Mathieu-RYDER	225
Matson	286
Matzenauer	466
MAURER COLLIN	76
Maunder	609
MAYFIELD	313
MAYO	19-33-92
MAYO (Bedienen & Präparierschere)	28-451
Mayo-ADAMS	183
Mayo-BLAKE	448
MAYO-Collin	147
MAYO-Guyon	445

INDEX (français)



	PAGES #
PATTIGROVE	507
Payr	236
Payr (Payr-BABY)	432
Schen	102-107-259
PEDERSON	462
PAIRS-Bertram	128
PEET	94
Pelkmann	131
PELTSON	196
PENFIELD	394
PENNINGTON	102-590
Perkussionshämmer	242
PERCY	305
PERTHES	322
Périnée Dammscheren	49
Raspatories Periostale	285-288-289-290
Vasculaire périphérique KLEMMEN	361
Péritonéale CLAMP und Hysterektomie PINZETTE	126
Phaneuf	122
PHACO Zubehör	512
PIERCE	260-590
Pieres	528
Pieres-Hoskin	536
Piffard	418
PIGTAIL	517
PINARD	241
PITHA	609
Plastische	20
Plester	175-252-554
Plester-Spatel	196
POTTS-DE MARTEL	69
POIRIOER	265
POIRIOER TRIUAT	265
POLLOSON	163
POOLE	253
POLACK	528
FLEISCHUNTERSUCHUNG SET	14-18
POTTS 375	
Potts-Smith (Vascular Schere)	22-41-42-43
POSTTS-SMITH (vinaigrette & Chirurgische Pinzette)	85-90
Politzer	573
PRATT	101-196-436-473
CHOPPER PRE	502-534
PRE-Chopper für Weichen étoile	502-534
PREIS-THOMAS	349
PRINCE	46
SONDEN	195-196
PROVIDENCE	106
INTRA PROVIS	457
PUTTI	282
Q	
QUEEN sqaure	243
Quervain	291
Quinby	78
ETWAIGE	566

R

	PAGES #
Rabiner	243
RALK	94-320
RAMSAY	92
RAMUS	169
RANDALL	446
RANEY	392
RANPLEY	135
Rangell DAVIS	144
RASIERKLINGENSTÄRKE gepreist	16
REKTALE SPECULAS	436
Récamier	490
REINER	261
Resano	426
SPATULE RÉTINIENNE	505
RETRAKTOREN	140-153-174
Retraktoren und OS RETRAKTOREN	148-149-150
RETRAKTOREN Kiefer-und Gesichtschirurgie	168-170-172
RETRAKTOREN und Meniskus RETRAKTOREN	158
Reverdin	166-234-235
REYNOLDS	20-22-38
RIB Scheren	337
RICARD	184
RICHARDSON	159-160
RICHARDSON-Eastman	159
RICHTER	27-184
RICHTER-HEATH	240
RIGBY	185
RITTER-HALLE	605
Rizzuti	514
ROBB	387
ROBERTS	112
ROCHARD	193
Rochester-Carmalt	108
ROCHERTER-schen	107
ROEDER	129
ROGER	121-514-591
ROLLET	513
ROLLE	517
ROSE	143
ROSER-König	610
ROSEN	498-554-555-558
Rosenbaum-DREWS	514
ROSS	167
Röttgen-RUSKIN	314
Rotunda Hospital	457
ROWE	631-634
ROUX	146
FUBIN	592-602
RUDD	442
Rumel	114
Rumel-Belmont	388
RUSKIN	313
RUSKIN-LISTON	317
RUSS. MODELL	92
RYDER	223
Rydel-Seiffert	563

S	PAGES #		PAGES #
Saalfeld	418	SEUTIN	75
SACHS	393-397-399	SEXTON	573
SAKAMOTO	633	SHAMBAUCH	557
Salyer	633	Shapleigh	569
Salyer (CLAFT GAUMEN INSTRUMENTS)	643	SHEA	557-623
SALENIUS	300	SHORTBENT	70
SANDERS-BROWN	173	SIEBOLD	20-34-36
Santulli	352	Silia UND Deckglaspinzetten	96
SANVENERO	40	SILBER	595
Saenger	547	SIMS	20-34-35-436-463-474-489
Sarot	113-216-223	SIMS-Maier	131
Satinsky	43-350-369	SIMON (PISTULA MESSER)	08
SATTEERLEE	319	SIMON	161-278-482-489
SAUER	493	SIMPSON	546
Sauerbruch	154-163-315-338	SIMPSON BRAUN	546
Sauerbruch-FREY	338	SIMPSON LUIKERT	546
SAYFFERT	462	SIMPSON-SMITH	255
Skalpellgriffe	02/01/03	Smellie	548
Schadel	128	534 Snellen	93
Schede	277	Singley-Tuttle	497-530
Schanz	330	Sinskey	607-608
Schamberg	418	Sinus Lift Küretten	476
SCHINDLER	126	Skene	299-300
Schink (Hauttransplantation MESSER)	15	Smillie	72
SCHMID	200	SMITH	637
Schmidt-Rimpler	526	SMITH (sagittale Spaltung Separatoren, RAMUS)	437
Schmieden	233-238	SMITH-BULE	74
Schmieden-DICK	238	SMITH (MOD. USA)	269-314
Schmieden-Payr	284	Smith-Peterson	398
SCHNEIDER	284	Smithwick	170
SCHNEIDER-Sauerbruch	111	SOERESSEN-Hein	481
SCHNIDT	71	SOMER	457
Schoemaker-Loth	415	Spackmann	15
Schönborn	475-476	Ersatzklingen	70-538
SCHRODER	484-485	SPENCER	70
SCHUBERT	625	Spencer-FINE	120
Schuchardt	72-554	Spencer Wells	280
Schuknecht	48-296-486-488	SPINALE	169
SCHUMACHER	136	SPINA-nasalis	514
SCHWARTZ	187-396	Spivey	94
Scoville	187	Splitterpinzette	276
Scoville-Haverfield	187	SPRATT	88
Scoville-Richter	423	STANDARD-Adson	81-86-87
Scudder	433	STANDARD (vinaigrette & Chirurgische Pinzette)	80
Scudder / Sudder-ATRAUME	292	STANDARD (GUM-und Nagelscheren)	23-24-39
SEBILEAU	283	STANDARD (Betriebs-und einer Feinen Schere)	258
Sedillot	480	STANDARD (NELSON)	195
SEGAND	126	Stacke	628-629-632-635
Segond	126	STEINHAUSER	639
Segond-Landau	548	Steinhauser (MYLOHYOLD MUSCLE und Ramus KLAMMERN)	641-642
Sellheim	284	Steinhauser (ostéotome)	334-335
Seldin	347	STEINMANN	501-533
Sellers	288-304-311-317-349	STEINERT	539
Semb	82-89	STERN-Kiemen	256-615
Semken (vinaigrette & Chirurgische Pinzette)	191	STERNBERG	21-67-210-538-543
SEMM	144	STEVENS	495
Senn-GRÜN	144	STEVENSON	75-76-81-263-272-315-321-445
Senn-MILLER	524	STILLE	93
SERREFINE		Stille-Barraya	

W

	PAGES #
Wachenfeldt	240
WAGENER	572
WAGNER (Leichtbetriebsmodus Schere)	20-37-290
Walb	10
WALDMANN	48
Waldau	526
WALLEIX	474
WALTER	592-594
WALTER-Carmalt	94
WALTON	39
Wangensteen	85-216-224
WARTENBERG	241
Wassmund	152
WATSON-CHEYNE	195-292
Watson-Williams	583
Waugh (vinaigrette & Chirurgische Pinzette)	83-90
WEBER	241-367
WEBER-LOCK	571
WEBSTER	214-222
WECKER	52
WEISS	492-495
Weitlaner	176-178
Weitlaner-BABY	177
Weitlaner-Wullstein	176
WELLER	34
WEIL	583
Weil-BLACKESLEY	584
Wellet-Martel	548
WERTHEIM	35-124-125-127
Wertheim-CULLEN	124
WESTCOTT	540
OUEST	520
WELLS	516
WICKSTROEM	119
WILDER	518
WIEN	239
WIENER	597
WIEDER	617
WILLS Krankenhaus	518-526
WILLIAMS	421-494
Williger	277-281-284-285-291-332
WILMER	68
HIVER	547
Drahtschneidezangen	325-326-327
FIL EINSTAPELUNG FORCPS	323-324
WRIGLEY	546
WOLF	263-419
WOLFORD	633
Wolford (ostéotome)	642
PLAIE und Nerven HAKEN	138
PLAIE und Luftröhre RETRAKTOREN	141
Wullstein	552-554

Y

	PAGES #
Yankauer	254-255-291
Yankauer UNIVERSAL	255
Yasargil	203-205-251-407-414
YEOMAN	440
Yeoman (TURRELL)	440
JEUNE	234-256-452-619

Z

	PAGES #
Zaufal	571
ZENKER	114-165
ZIEGLER	96-517-532
ZWEIFEL	123-226
ZOLLNER	560
Zielke	272

ÍNDICE (Español)



A	PAGES #		PAGES #
Retractores abdominales	181-190-193-194	Axenfeld	513-518
Estómago e intestinos cubo de	166	Axenfeld CURRETTES	517
ADLER Kreutz	89	Ayre - retractor de carrillos	257
Adson Brown	88	AYRE - GANCHO FÍSTULA	482
Hueso Adson gubia	312	Ayer - PINZAS	534
Adson Pinzas de disección	46		
Adson pinza	82		
Adson NORMA PINZAS	82		
Adson Guía de broca	322		
Adson DURA GANCHO	399		
Adson (tijeras)	46		
Adson Multa	46		
La disección de Adson hemostático	109		
Adson Ligadura	95		
Adson aderezo con fórceps	97		
Adson NEEDLEHOLDERS	217		
Adson perióstica Raspatories	285		
Adson RETRACTORES	178-179-180		
Adson NORMA	82		
Adson tubos de succión de	252		
Pinza Adson tejido	88		
ADLER	523		
AEBIL	54		
AFRICH	599		
ADAMS	609		
ASCH	603		
Erigir	596-601		
AGRICOLA	475-495		
ALDERDYCE	292		
ALEXANDER- cinceles de hueso	268		
ALEXANDER - perióstica Raspatories	284		
ALEXANDER - pinza de biopsia uterina	487		
TODO	430		
ALLIS	420		
ALLIS-ADAIR	420		
ALLIS-Atrauma	420		
ALLISON	348		
ALLPORT	174		
ALM	174		
ALEXANDER	487		
ALY	241		
AMPUTACIÓN CUCHILLO	09		
Y pinzas vasculares PEDICTRIC grapas anastomosis	379		
Anderson Adson-	178		
Andrew PYNCHONE	254		
ANIS	518		
Arnest	502		
ARRUGA	210-211-213-227-493-542		
ARRUGA - EYE espéculos	493		
ARRUGA - soporte de la aguja	542		
Atrauma	136		
Atraumática FACO	506		
FLECHA SMITH	511		
ARNHEM	635		
Erigir	596-601		
ASCH	602		
AUSTIN	84-557		
AUVARD	470		
Axhausen	218-226		
		B	
		BABCOCK	200-421
		BABCOCK atraumatique	421
		BABCOCK (NORMA)	421
		Babinsky	243
		Adson BÉBÉ	109
		BÉBÉ ALLIS	420
		BABCOCK POUR BEBE	421
		BALFOUR BÉBÉ	188
		BEBÉ BARRAQUER	493
		BÉBÉ COLLIN	182
		BÉBÉ Crile	105
		Baby-BOIS Crile	220
		DOYEN DE BEBE	423
		Hegemann BEBE	44
		Baby-KOCHER	428
		BÉBÉ Lexer (Knapp)	40
		Metzenbaum BÉBÉ	19-29
		Mikulicz BÉBÉ	127
		MIXTER BÉBÉ	118
		BEBÉ HEGAR OLSEN	217-228
		Overholt BÉBÉ	114
		BÉBÉ POOLE	253
		Baby-ROUX	146
		Satinsky BÉBÉ	350
		Senn-MILLER BÉBÉ	144
		Backhaus	128-524
		BACON	309
		BAILEY	347
		BÉBÉ BAILEY	347
		BAILEY-Gibbon	347
		BAINBRIDGE	110-362
		Hornea	44
		Ballenger - HAJEK	590
		BALLENER	588-593
		BALFOUR	188-189-190
		Balfour-nous Tipo	190
		Boule et PRISE	129
		Ballentine	122
		Ciseaux VENDAJE	74
		FIL ET COUPE DE VENDAJE Ciseaux	72
		Bane-HARTMANN	308
		BARBARA	555-556
		Bard-Parker	544
		BARD PARIIZER	544
		BARR	437
		BARRAQUER	52-95-212-499-504-526-532-539-542
		BARRAQUER COLIBRI	493
		Barsky	139

B

BARTH	281
BAUER	640
Belucci	175
Bengolea	111
BENNETT	95-298
Bensaude	437
BENSON	430
BERGMANN	07-73-142-151-331-332
Berke	534
BERLIN	242
BERNHARD	129
Bertillon	244
BEAUPRE	95
Beacham	475
Bechert	496
Bechert-Mc PHERSON	500-529
BECKMANN	180-604
Beckmann-Adson	179
Beckmann EATON	181
BeeBee	77
CERVEZA	96-532
Beeson	262
BESNIER	419
BEYER	310
BEYER Zaufal JANSEN	313
Bircher	300
Billeau	571
Bircher-Ganske	302
Birkett	111
EVEQUE	616
OBISPO-Harmon	499-525
SPREADORS LAMINA PARA cuchillo	400
BLAKE	448
Blaydes	501-531
Pistolas y SET de Inspección de Carnes	14-18
BLOUNT	153-158-298-299
BLUMENTHAL	310
BOHLER	313-316
BONACCOLTO	526-531
Cinceles de hueso	264-265-271
Curetas	276-277-279-280-281
Hueso de perforación	320
Para utilizar limas y escofinas	282
Tijeras Eye OS	67
OS Böhr	273
Para utilizar los clips de retención	307
Bone Pinzas	301-306-307
Bone Pinzas CENTRO AUTO	305
OS PALANCA	293-294
La espina	330
CISAILLEMENT OS	75
BONN MODELO	538
Bonney	83-93
AGUJEROS	508-510-511
BOSE	174-415
Boettcher	46
Bowdler de-Harry	172
BOWLES	493-517
BOWLES	241

BOYNTON	211-227
BOZEMANN	134-222-239-471
BOZEMANN DOUGLAS	135
BOZEMANN FRITSCH	457
Cerveau RETRACTOR	407
MARQUE	108-334-336
BROWN	48-466-467-474-475-478-549
Braun-Stadler	21-48
Breisky	470-545
BRIAN ascensores y	397
BROWN	89-214
Brunetti (cuchillos de la autopsia y cinceles)	13
BRUNNER	162-236-237-238-338-427
Brunner-FERROZALL	238
BRUNS	74-274-276
Brunings	568-582-588-618
BRYANT	132
BUCCI	552
BUCK	242-566-569-570-573
Buck-Gramcko	293
Bülau	259
Buie	123-196-441
Bulldog Clamps	354
BULLDOS PINZAS	136
BULLDOG arterias terminales	101
BUNGE	515
BURFORD	343
BUSCH	48
Bushe	279
BEYER	522

C

CANAD MODELO	300
C-DE ACERO	543
Caroll	244-335
Carrel	101
CARTLIAGE diámetro de	11
CAJA DE CARTON	457
CASPER	155-401
CASTAÑEDA	341-386
Castroviejo	16-54-56-201-202-211-212-528
Castroviejo (INSTRUMENTOS glándula lagrimal)	495-499-504-517-519
Castroviejo (tijeras)	540-541
Castroviejo (soporte de la aguja)	542
Castroviejo (rebelión)	543
Castroviejo FRÍO	210-542
Catlin (cuchillo de amputación)	09
Cauchois	266
Cawood Minnesota	616
Pinces Cervicales de tracción	391
CHADWICK	68-80
CHANDLER	298

ÍNDICE (Español)



	PAGES #		PAGES #
Chaput	101	Cushing (fórceps)	85-90
CHARRIERE	319	CUSHING	137-143-145-321-398
Chevalier Jackson	416	CUSHING de la caldera	145
CHERON	134	CUSHING TAYLOR	85
NATURALEZA	240	Czerny	155-436-448-478
Boquilla	271		
Cincel-Courbe	271	D	
MANDRIN POIGNEE	544	DAHIGREN	390
CINELLI	594	DALE	357
Citelli	522-568	DANDY	51-69-108-398
Citelli BEYER	568	Dardik	356
Clayman	531	Dartigues	481
CLTTLE	578	SASTOOR	519
CLEVELAND	309-316	Daube tocino	278
Tijeras de ropa	75	DAVIDSON	167
RIB y yeso tijeras de	75	DAVIDSON-ALEXANDER	284
Clovis Vicente	308	Davis:	394
Cloward	402-403	DAVIS BOYLE	612
COAKLY	260-604	Dean	79
Coaptación	535	Deaver	26-164
COBB	257-273-287-290	Deaver Agarradera	164
Cohan	528	De Bakey	41-44-97-185-221-345-354-360-361
COCINAR	494	De Bakey	362-363-364-365-366-367-372-374-377-378-379-380
Colclough	410	De Bakey Bahnson	373
Coller Crile	106	De Bakey BECK	379
COOLEY	167	De Bakey FINO	221
Collier (soporte de la aguja)	214	De Bakey MOSQUITO	355
Collin (bisturí)	01	De Bakey, entre	376
COLLIN	102-134-147-181-182-183-240-244-256	De Bakey Rankin-	355
COLLIN	460-481-545-549-619	De Bakey Satinsky-	351
Collin-Duval	92	Deitz	508
Collin-Hartmann	146	LEE DE	545
Collin-Landau	460	DE Martel Wolfson	435
Coller Crile	106	De Vilbiss	390
Colley	359-381-382-383-389	Deaver	26-164
Collyer	545	Deaver Agarradera	164
Colley (Colley-BABY)	341-342	DEMEL	329
Colibrí	535	Denis-Brown	192
CONO	178	Denhart	610
Cono (Adson-BABY)	177	Derf	214-222
Connel	256	Derra	379
Converse	220	DESCHAMPS	229-230-231
COOPER	233	DESCHAMPS NORMA	229
Cottle	21-50-586-589-591-592-596-599-600-601-603	DESJARDINS	447-448-449-450
Cottle Walsham	602	Desmarres	143-513-520-535
Cottle NEIVERT	600	Deyen	36
Hisopo de algodón	197-198	DE- ALARMA	539
CONVERSE	586-599	Dieffenbach (hemostáticos)	101
CORYLLOS	163	Dieffenbach (en funcionamiento knif)	06-07
Crafoord	47-113-158	Diethrich	136-213-355
Crafoord-Sellors	113	Dingmann	170-171-301-614-628
Crile	105-137-143-218-388	Dingmann MODIF	301
Critchett	495	Dingmann Wilk-	628
Crile-BOIS	217-220	Preparación y tijeras neuroquirúrgicos	68
Tijeras de la Corona	77	Tijeras de disección y amígdalas	46
CRUTCHFIELD	391	Cubiertos	17
CRUNWALD	565	Dittel	455
CUSCO	459	DIXON- Lovelace	110
CUSCO (Imagen suiza)	459		

	PAGES #
DIXON- Lovelace	110
Dockhorn	168
Marqueur DOBLE	510
DOUGLAS	96-260
DOYEN	129-161-193-288-423-468-469-480-618
DOYEN atraumatique-	424
DOYEN ROCHARD-	193
DOYEN SILENT-	161
Pinzas	81-83-384
Dibujó Smythe	457
Guía de broca y proteger DURA PINZAS	322
DUVAL	92
DURANTE	92
DUBOIS	35
Dunhill	108
Duplay	131-475
DUPLEX	241
Dupuy- BLANCO	232
DURA disectores	394-395
DURANTE	92
DURHAM	232
DUVAL	422



EASTMAN	464
JERINGAS EAR	575
Echlin	315
Eiselsberg	71
Elevadores	291
ELCKEN -Killian	605
Elschnig	527
Emmett	482
La endarterectomía	200
ENGEL	261
ENGL. MODELO	81-128
Enucleación	538
EPSTEIN	280
Epker	640-641
Epker BAUER	640
Erhardt	535
Ermold	217
ERNEST	534
Esmarch	73-261
Ewald,	82
Ewald,	88
ARC extensión de	328
Extra RETRACTORES oral	620
LOS OJOS Y tijeras finas	65-66-67
OJO con fórceps	525
Tijeras del ojo	66-67-68-537



	PAGES #
FORD	531
Farabeuf	147-267-283-305
Farabeuf-Collin	283
Farabeuf Lambotte-	306
Farrell (Farrell-Lathbury)	197
Farris-Smith	92-411
Farris-Smith-Kerrison	408-409-587
Farrior	560
FAURE	125-126-484
Favaloro	41
Fehland	427
Feilchenfeld	94
FINO	196
FERGUSSON	27-122-251-302-451
Feaster	531
Fiat	558
FINO	501-533
THORNTON FINO	506
Pinzas finas y Splinter	91
Tijeras de modo ligero de	37
Tijeras finas	39-40
Finochietto	47-119-216-224-339-343
Finochietto BÉBÉ	339
Finochietto-BABY- Haight	341
Finochietto, Burford	340-344
Finsen	174
Siniestro	253
Repositor FLAP	496
PISO	558
EJE FLEXIBLE	488
FISCHER	334
POISSON	195
CUCHILLO FÍSTULA	08
FOERSTER	135
Fomon	21-50-586-594-597-598-599-600
FOX	419
FRANCIS	194
FRANK Feldt	198
FRAZIER	137-186-251-252
FREER	520-588-589-591
FRANCES	561
FRIEDMANN	302
Friedmann DÉLICATS	309
FRITSCH	161
Frykholm	315
Foxy	110
Agente d'avitaillement	416
Fukasaku	498-507

ÍNDICE (Español)



G

	PAGES #
Graefe	526
TERMINALES disfunción biliar	123
GARLAND	123
GASS	521
FER	548
GALLAHER	596
Gellhorn,	484
Gelpi	184
GERARDO	84-90
Gerbode	389
GERZOG	333
Giertz-CALMA	338
GIGLI	390-518
GILLIES	89-137-172-218-228-419-628
GILLIES SLIM	218-228
Gil Vernet	140
Gills Vännäs	539
Las branquias de Gales Vännäs	539
Gimini	117
GIRARD	528
Glick	337
GLOBO DE FIJACIÓN	506
GLOVER	351-353-378
GLUCK	75
Goelet	146
GOLDSTEIN	493
Goldman-Fox	51-78
Goldsmith (Thudichum)	576
De	47
GOSSET	185-186
Gradle	95
Graefe	68-91-138-494-520
Graether	514
GRAHAM	399
Grandon	511
GRAVE	461
GRAVE (NORMA)	461
GRAY	447
Delicado	26
VERDE	158-527
VERT- Armytage	547
GREGOIRE	422
GREGORY	352-358
GREGORY SUAVE-	352
GRONINGEN	398
Gross- MAIER	131
GRUNWALD	85
Grunwald (Janson)	580
Guilen	605
Las encías y uñas Tijeras	80
Tijeras Goma	78
Guthrie (gancho PLAIE y de los nervios)	138
GUTTMANN	458
GUYON	444-456

H

	PAGES #
Haberer	166-434
HAFMANN THORNTON	506
HAGEN BARTH	240
HAGLUND SILENT-	262
Haight	342
HAJEK	413-587
Hajek-Kofler	413-587
Håkansson	310
Intenso y completo -CERVEZA	319
HALL	50-279-399
Halsey	214-220
Halstead-moustiques	103-104
HAMILTON POUR BEBE	257
HANK	473
Hargis	627-633-636
HARKEN	350-368
DAÑOS	499-517-528
Harms Jafe	499-530
Harrington-BABY	164
HARTMANN	103-309-524
HARTMANN	559-561-562-563-564-566-567-571-580-581-617
HARTMANN HOFFMANN	567
Hartmann Salón	576
HARTMANN NOYES	567
HARTMANN Wullstein	567
HARTMANN WEINGATNER	567
HARVEY	72
Hasted	524
Hautant	264-266
HAYES	426
HAYES PROVIS	457
Lampe frontal de	243
Heaney	121-165-215
Heaney-Ballentine	122
Heaney-SLIM	121
Heath (tijeras de ligadura)	71-332
HEATH	535
Hebra	418-515
HEES	525
Hegar	215-472
Hegar-Baumgartner	214-221
Hegar vascular	223
Hegemann (Diethrich)	44
Heister	610
HOT	116
Hemostáticos	102-104
HENLEY	177-406
Henner (Lempert)	176
HENNING	262
HENRY	95
HEOSEL	156
HEPP Schiedel	212
Herrick	445
Hertzler	186
HEY	404
HEY GROVES	303
HEYMANN	21-50-581
Heywood-Smith	441

Hibbs	
HIRSCHMANN	
Hocky CUCHILLO	
HOFFMANN	
HOFFER	
Hohmann	
Hohmann secretario de Defensa	
Hohmann Williger	
HOIZHEIMER	
HOKE	
HOLSHER	
Holth	
HOPKINS	
Horsley	
Hosel	
CASA DE	
DIETER MAISON-	
HUDSON	
Humby	
CAZA DE	
HOZLBACH	
HHUNTER	
HYESTERECOTOMY PINZAS	
Hylin	

PAGES :-

165-272
437
507
130
509
294-295
296
292
175
269
396
523
261
396
227
558
553
321
15-139
534
123
94
122
286

J

JACKSON	
JACOBSON	
Jacobson-Adson	
JACOBSON-HALSTEAD	
JABOMA	
JANSEN	
JANSEN-PROFUNDA	
JANSEN (Gruenwald)	
JAMESON	
Javid	
JAWS profundidad de	
Jeffe	
Jees	
JENNINGE	
JETER-Van Sickels	
Jhones	
JOBOMA	
Jobson Horne-	
Johns Hopkins,	
JOSÉ	
JOSÉ Masing	
Judd-Allis	
Judd-Masson	
Judet	
JOYEROS	

PAGES :-

139-142-463
58-202-213-281-477
82-109
103
643
97-175-281-284-310-312
175
97
20-38-38-216-565-570
358
179
513-540
526
614-615
632
128-524
98
197
101-114
40-520-586-589-591-595-596-599-600
591
421
453-454
266
529-535

I

IMPECTOR	
INGE	
Tejido intestinal y el órgano Grasing PINZAS	
Espátula de INTIMA disectores VASCULAR	
IOWA	
LIO INSERTIN PINZAS	
Tijeras de iridectomía	
Iris pinzas de	
IRIS tijera	
RETRACTORES intraorales	
ISRAEL	
Iterson	
Ives-Fansler	

264
403
422
387
477
501
52-53-54
525
537
621-622-623
152
142
438

K

KADER	
KALMORGEN	
FRÍO	
FRÍO ARRUGA	
KANSAS	
KANTRIWITZ	
Katzin	
Katzin BARRAQUER-	
Kazanjian	
Kelsey-República Federativa de Yugoslavia	
KEEN	
Kelman-McPherson	
KELLY (tijeras)	
KELLY (pinzas)	
KELLY (retractores)	
KELLEY	
CENTRAL	
Kerrison	
Kevorkian	
KEY	
KEYES	
Kielland	
KILLIAN	

166
467
210-212-542
210
516
113
55-541
55
317-585
173
632
500-530
36
104-112
159-160-163
521
303
523-568
486
292
419
546
577-581-590-593

	PAGES #		PAGES #
Baja	117	Mayo-Hegar	215-220-221-223-227
Lowman	307	Mayo-Robson, Mayo-Robson atraumatique	425
Lowman Hoglund	307	RYDER Mayo	223
Lubet-Barbon	580	Mayo STTILE	19-28
LUC	582	Mayo-Noble	29
Lucae	97-333-562-563-572-573	McDONALD	292
LUER	143-312-416	Mc CULLAUGH	526
LUER Korte	450	McGivney	443
Lukens	139	McGEE	553-556
Luntz-Dodick	521	McGuire	539
Poumon PALA	348	McPherson	500-530-535-543
		McPherson WESTCOTT	500-530-535-540
		Mellinger	494
		Mellinger Axenfeld	493-494
		BARBE Mellinger	494
		MCKENZIE	321-392
		McKenty	589-590
		Mclvor	613
		MC. QUIGG MIXTER	119
		McIndoe	43-82-316
		MEAD	310-333
		metros	244
		Meeker	117
		MENISUCS RETRACTOR	299
		MENDEZ	508
		MERCEDES-retractor de	346
		Mershon	173-631
		METZ	625
		METAL CATÉTER y Introdutores	456
		Metzenbaum	19-30-31-32-33-227
		Metzenbaum FINA	19-29-30-31-32-33-227
		Metzenbaum FINO	33-34
		Meyerding	142-165-184
		MG H	216
		Amplia base de	515
		MICHEL	240
		MICHEL	240
		MICHEL MODIF	240
		Micro-Adson	82-88
		La disección de Micro	100
		Micro pinzas de	99
		Micro pinzas de	84
		Micro Ear Forceps	550-551
		MICRO-Hoe y PAI-Schaler	496
		MICRO MOSQUITO	103
		Porta-agujas micro	203-204-205-206-207-208-209-504
		Micro Tijeras	57-58-59-60-61-62-63-64
		MICRO RYDER	223
		Middeldorpf	158-159
		MIDDLETON- Janson	585
		MIGIVNEY	442
		Mikulicz	126-127-162
		MILLER	137
		Milligan	177-393
		Millin	255-452-453
		MOULINS	69
		MINI-FRIEDMANN	308
		GÉMINIS MINI-	118
		MINI-Hohmann	293

M

MACEVEN	267
Magill	255-256-257
Magahara	498
Magill (nasal)	257
Maltz	596
BAGUETTES	331-332-333
Maleable NEGRO	252
MALONEY	503
Mangiagalli	469
Markham Meyerding	185
Markwalder	316
MARQUARDT	314
MARTEL	124-390
MARTIN	162-302-545
MARTIN cartilago de	43
MARTINI	281
MARTEL	124
Masing	591
Casanovas	503-532
MASSON	216-224
Mastin	417
MATHIEU	147-219-225-227-436-458-468
Mathieu-MAKER	226
Mathieu-RYDER	225
Matson	286
Matzenauer	466
MASON COLLIN	76
Maunder	609
MAYFIELD	313
MAYO	19-33-92
MAYO (funcionamiento y la disección de las tijeras)	28 -451
Mayo ADAMS	183
Mayo-Blake	448
MAYO-Collin	147
Mayo-Guyon	445

	PAGES #
PATTIGROVE	507
Payr	236
Payr (Payr-BABY)	432
del	102-107-259
PEDERSON	462
PARES-Bertram	128
PEET	94
Pelkmann	131
PELTSON	196
PENFIELD	394
PENNINGTON	102-590
Martillos de percusión	242
PERCY	305
PERTHES	322
Périnée episiotomía Tijeras	49
Perióstico Raspatories	285-288-289-290
Vasculaire périphérique TERMINALES	361
ABRAZADERA PINZA histerectomía y peritoneal	126
Phaneuf	122
FACO accesorios	512
PIERCE	260-590
Pieres	528
Pieres Hoskin-	536
Piffard	418
PIGTAIL	517
PINARD	241
Pitha	609
Plástico	20
Plester	175-252-554
Espátula-Plester	196
POTTS-DE MARTEL	69
POIRIOER	265
POIRIOER TRIUAT	265
POLLOSON	163
POOLE	253
POLACK	528
Inspección de la Carne SET	14-18
POTTS	375
Potts-Smith (tijeras vasculares)	22-41-42-43
POSTTS-SMITH (vinagreta y unas pinzas quirúrgicas)	85-90
Politzer,	573
PRATT	101-196-436-473
CHOPPER PRE	502-534
PRE-picadora para los interruptores étoile	502-534
Thomas Price	349
PRINCE	46
SONDAS	195-196
PROVIDENCIA	106
INTRA PROVIS	457
Putti	282
Q	
REINA sqaure	243
Quervain	291
Quinby	78
CUALQUIER	566

R

	PAGES #
Rabiner	243
RALK	94-320
RAMSAY	92
RAMA	169
RANDALL	446
RANEY	392
RANPLEY	135
Rangell DAVIS	144
FUERZA DE RAZOR INTERRUPTORES	16
RECTAL espéculos	436
Récamier	490
REINER	261
Resano	426
Spatule RÉTINIENNE	505
RETRACTORES	140-153-174
Los retractores y RETRACTORES OS	148-149-150
RETRACTORES cirugía maxilo-facial	168-170-172
SEPARADORES SEPARADORES menisco y	158
Reverdin	166-234-235
REYNOLDS	20-22-38
RIB Tijeras	337
RICARD	184
RICHARDSON	159-160
Richardson-Eastman	159
JUEZ	27-184
JUEZ DE HEATH	240
RIGBY	185
CABALLERO DE LA SALA	605
Rizzuti	514
ROBB	387
ROBERTS	112
ROCHARD	193
Rochester-Carmalt	108
ROCHERTER-entre	107
Roeder	129
ROGER:	121-514-591
ROLLET	513
PAPEL	517
ROSE	143
Roser-King	610
ROSA	498-554-555-558
Rosenbaum DREWS-	514
Ross	167
Röttgen Ruskin-	314
Rotunda Hospital,	457
ROWE	631-634
ROUX	146
FUBIN	592-602
RUDD	442
Rumel	114
Rumel-Belmont	388
Ruskin	313
Ruskin-LISTON	317
RUSS. MODELO	92
RYDER	223
Rydel-Seiffert	563

ÍNDICE (Español)



S

	PAGES #		PAGES #
Saalfeld	418	Seutin	75
SACHS	393-397-399	SEXTON	573
SAKAMOTO	633	SHAMBAUCH	557
Salyer	633	Shapleigh	569
Salyer (INSTRUMENTOS CLAFT paladar)	643	SHEA	557-623
Salenius	300	SHORTBENT	70
SANDERS-BROWN	173	Siebold	20-34-36
Santulli	352	Silia y el cubreobjetos con fórceps	96
SANVENERO	40	PLATA	595
Singer	547	SIMS	20-34-35-436-463-474-489
Sarot	113-216-223	SIMS Maier	131
Satinsky	43-350-369	SIMON (CUCHILLO PISTULA)	08
SATTEERLEE	319	SIMON	161-278-482-489
SAUER	493	SIMPSON	546
Sauerbruch	154-163-315-338	Brown Simpson	546
Sauerbruch-FREY	338	SIMPSON LUIKERT	546
SAYFFERT	462	SIMPSON-SMITH	255
Bisturí maneja	01/02/03	Smellie	548
Cráneo	128	Snellen	534
Schede	277	Singley-Tuttle	93
Schanz	330	Sinskey	497-530
Schamberg	418	Elevación del seno cureta	607-608
SCHINDLER	126	Skene	476
Schink (cuchillo de injertos de piel)	15	Smillie	299-300
SCHMID	200	SMITH	72
Schmidt Rimpler	526	SMITH (sagital RAMA separadores)	637
Forja	233-238	SMITH-BULE	437
Forja DICK	233	SMITH (MOD. EE.UU.)	74
Forja Payr	238	Smith-Peterson	269-314
SCHNEIDER	284	Smithwick	398
SCHNEIDER Sauerbruch	284	SOERESSEN Hein-	170
SCHNIDT	111	SOMER	481
Schoemaker-Loth	71	Spackmann	457
Schoenborn	415	Las cuchillas de repuesto	15
SCHRODER	475-476	SPENCER	70-538
SCHUBERT	484-485	Spencer-FINA	70
Schuchardt	625	Spencer Wells	120
Schuknecht	72-554	Spinale	280
SCHUMACHER	48-296-486-488	Espina nasalis-	169
SCHWARTZ	136	Spivey	514
Scoville	187-396	Splinter pinzas	94
Scoville-Haverfield	187	Spratt	276
Juez Scoville	187	NORMA Adson	88
Scudder	423	STANDARD (vinagreta y unas pinzas quirúrgicas)	81-86-87
Scudder / Sudder ATRAUME-	433	STANDARD (tijeras GUM y de las uñas)	80
SEBILEAU	292	STANDARD (funcionamiento y unas tijeras pequeñas)	23-24-39
Sedillot	283	STANDARD (NELSON)	258
SEGAND	480	Stackebrandt	195
Segond	126	Steinhauser	628-629-632-635
Segond-Landau	126	Steinhauser (Ramus y CLIPS MYLOHYOLD MUSCULARES)	639
Sellheim	548	Steinhauser (osteotomos)	641-642
Seldin	284	STEINMANN	334-335
Sellers	347	STEINERT	501-533
Semb	288-304-311-317-349	STAR-de enmalle	539
Semken (vinagreta y unas pinzas quirúrgicas)	82-89	STERNBERG	256-615
SEMM	191	STEVENS	21-67-210-538-543
Senn-VERDE	144	STEVENSON	495
Senn-Miller,	144	SILENT	75-76-81-263-272-315-321-445
Serre-FINO	524	Silent Barraya	93

ÍNDICE (Español)



W

	PAGES #
Wachenfeldt	240
WAGENER	572
WAGNER (tijeras de luz de modo)	20-37-290
Walb	10
WALDMANN	48
Waldau	526
WALLEIX	474
WALTER	592-594
WALTER Carmalt	94
WALTON	39
Wangensteen	85-216-224
Wartenberg	241
Wassmund	152
Watson-Cheyne	195-292
Watson-Williams	583
Waugh (vinagreta y unas pinzas quirúrgicas)	83-90
WEBER	241-367
WEBER-LOCK	571
WEBSTER	214-222
ALARMA	52
BLANCO	492-495
Weitlaner	176-178
Weitlaner -BABY	177
Weitlaner Wullstein-	176
WELLER	34
DEBIDO A	583
Debido a que BLACKESLEY-	584
Wellet Martel-	548
WERTHEIM	35-124-125-127
Wertheim- CULLEN	124
Westcott	540
OUEST	520
POZOS	516
Wickström	119
SALVAJE	518
VIENA	239
VIENA	597
RE-	617
VOLUNTADES del hospital	518-526
WILLIAMS	421-494
Dispuesto	277-281-284-285-291-332
WILMER	68
INVIERNO	547
Alicates de corte de alambre	325-326-327
FIL Aprovechar FORCPS	323-324
WRIGLEY	546
LOBO	263-419
WOLFORD	633
Wolford (osteotomos)	642
GANCHO PLAIE y nervioso	138
PLAIE y retractores de la tráquea	141
Wullstein	552-554

Y

	PAGES #
Yankauer	254-255-291
Yankauer UNIVERSAL	255
Yasargil	203-205-251-407-414
YEOMAN	440
Yeoman (Turrell)	440
Jeune	234-256-452-619

Z

Zaufal	571
Zenker	114-165
ZIEGLER	96-517-532
DUDA	123-226
ZÖLLNER	560
Zielke	272



📞 +92 305 6529284 ✉ info@segitech.net

📍 Defence Road Kareem Plaza Sialkot 51310 Pakistan.

🌐 www.segitech.net